



5 SERIES 30", 36", AND 48"W. GAS RANGETOPS

Viking 5 Series – VRT

COMMERCIAL-TYPE COOKING POWER

- **EXCLUSIVE** – VariSimmer-to-High Pro Sealed Burner System
- Front right burner equipped with TruPower Plus 18,500 BTU burner on select models
- Burners equipped with 15,000 BTUs
- **EXCLUSIVE** – VariSimmer™ Setting for all burners
- **EXCLUSIVE** – All burners equipped with *SureSpark™ Ignition System* for consistent and reliable ignition
- Automatic re-ignition; surface burners light at any position on the knob and re-light if extinguished, even on lowest setting
- Heavy-duty BlackChrome™ knobs and square bezels shipped standard
- SoftLit™ LED lights accent the control panel and illuminate knobs
- Island trim ships standard with each rangetop and already attached

EASY OPERATION AND CLEANUP

- **EXCLUSIVE** – One-piece tooled and porcelainized cooking surface for easy cleanup
- Burner caps are easily removable for quick cleaning
- Heavy-duty, porcelainized, cast-iron removable surface grates provide continuous front-to-rear, left-to-right surface for easy movement of large pots

GRIDDLE/SIMMER PLATE – 12"WIDE (on select models)

- Available in 12" width
- Commercial-grade, machined steel construction with blanchard finish to retain cooking oils for stick-resistant cooking
- Thermostatically controlled for precise temperatures
- Cast grease trough can be easily removed from the front of the griddle for cleaning



MODEL NUMBERS

- VRT5304B – 30"W. Gas Rangetops; four burners
- VRT5366B – 36"W. Gas Rangetops; six burners
- VRT5364G – 36"W. Gas Rangetops; four burners with griddle
- VRT5488B – 48"W. Gas Rangetops; eight burners
- VRT5486G – 48"W. Gas Rangetops; six burners with griddle

ACCESSORIES

- BG8530SS – 8"H. backguard for 30" rangetop
- BG8536SS – 8"H. backguard for 36" rangetop
- BG8548SS – 8"H. backguard for 48" rangetop
- HS24530SS – high shelf for 30" rangetop
- HS24536SS – high shelf for 36" rangetop
- HS24548SS – high shelf for 48" rangetop
- P30CRTSS – countertop rear trim for 30" rangetop
- P36CRTSS – countertop rear trim for 36" rangetop
- P48CRTSS – countertop rear trim for 48" rangetop
- P24CSTSS – countertop side trim (2 pieces)
- LPKPDR – LP/Propane Conversion Kit

COLOR FINISHES

- Available in Stainless Steel (SS)



WARRANTY

- 2-year full – complete product
- 90-day full – cosmetic parts such as glass, painted items and decorative items
- 5-year limited – gas burners



5 SERIES 30", 36", AND 48"W. GAS RANGETOPS

Viking 5 Series – VRT

GAS 30", 36", AND 48"W. RANGETOPS			
DESCRIPTION	VRT530	VRT536	VRT548
Overall Width	29-7/8" (75.9 cm)	35-7/8" (91.1 cm)	47-7/8" (121.6 cm)
Overall Height (from bottom)	To top of burner grate – 9-1/4" (23.5 cm); to top of island trim – 9-1/8" (23.2 cm); to top of 8" h. backguard – 16-1/8" (41.0 cm); to top of high-shelf – 31-5/8" (80.3 cm)		
Overall Depth (from rear)	To end of side panel – 24-5/16" (61.8 cm); to end of landing ledge – 28-1/16" (71.3 cm); to end of knobs – 28-9/16" (72.6 cm)		
Cutout Width	30" (76.2 cm)	36" (91.4 cm)	48" (121.9 cm)
Cutout Height	7-3/4" (19.7 cm)		
Cutout Depth	24" (61.0 cm) minimum; 25-3/4" (65.4 cm) maximum		
Gas Requirements	Accepts standard residential 1/2" (1.3 cm) ID gas service line. Order either natural gas or LP propane; to field convert from natural to LP propane, order optional LP conversion kit.		
Electrical Requirements	120VAC/60Hz; 4 ft. (121.9 cm), 3-wire cord with grounded 3-prong plug attached to product		
Max. Amp Usage	0.5 amps		
Surface Burner Rating	Standard burners (each): 15,000 BTU NAT. (4.4 kW)/13,500 BTU LP (4.0 kW) TruPower Plus™ (front right) burner: 18,500 BTU NAT. (5.4 kW)/16,600 BTU LP (4.9 kW)		
Griddle Burner Rating	-	15,000 BTU NAT./12,500 BTU LP (4.4 kW NAT./3.7 kW LP)	15,000 BTU NAT./12,500 BTU LP (4.4 kW NAT./3.7 kW LP)
Approximate Shipping Weight	125 lb. (56.7 kg)	6B – 150 lb. (67.5 kg) 4G – 160 lb. (72.0 kg)	6G – 203 lb. (91.4 kg) 8B – 200 lb. (90.7 kg)

Please do not prepare installation from brochure data only. See installation instructions for important clearance/installation information.

30"W. RANGETOP

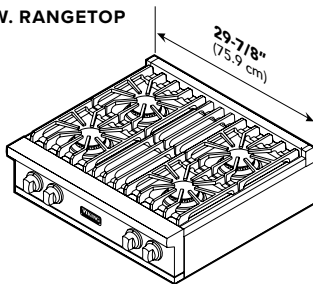

36"W. RANGETOP

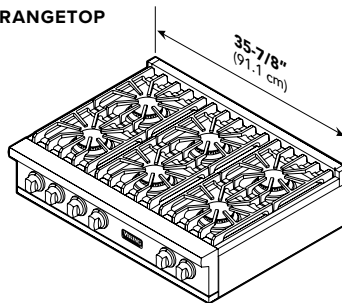

48"W. RANGETOP

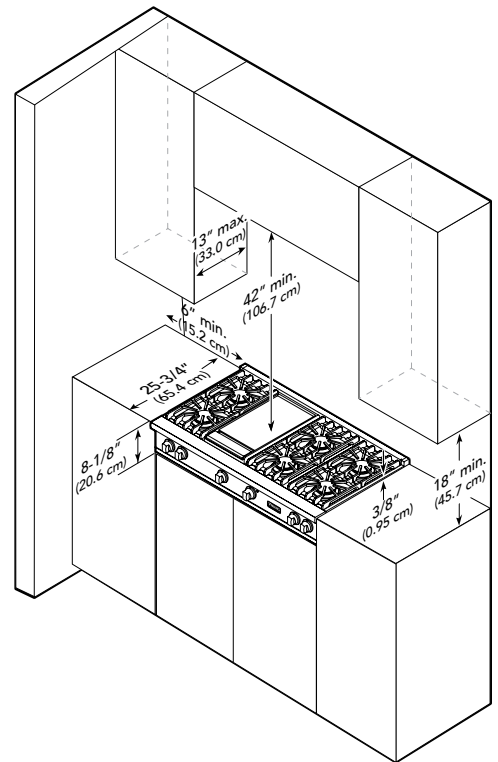
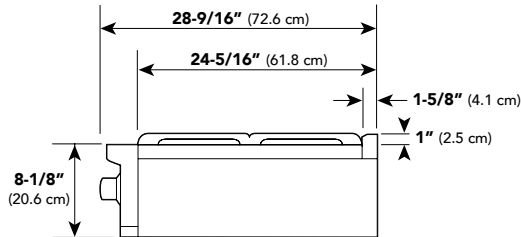
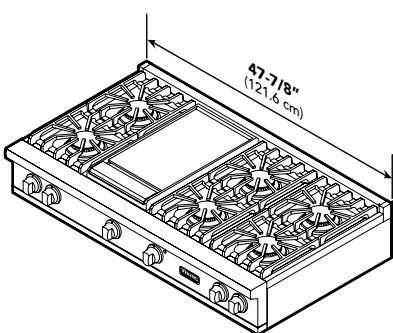

VIKING RANGE, LLC 111 FRONT STREET GREENWOOD, MISSISSIPPI 38930 USA

For detailed product information, model numbers, or to request a quote call 1-888-845-4641 or visit vikingrange.com
© 2024 Viking Range, LLC All rights reserved. Specifications subject to change without notice.