

UVC9480SLSS

48" Universal Custom Hood Insert

DIMENSIONS AND INSTALLATION INFORMATION (IN INCHES)

Installation Information: Before installing, consult installation instructions, packed with product, for current dimensional data.

AMP RATING	
120V	6.0

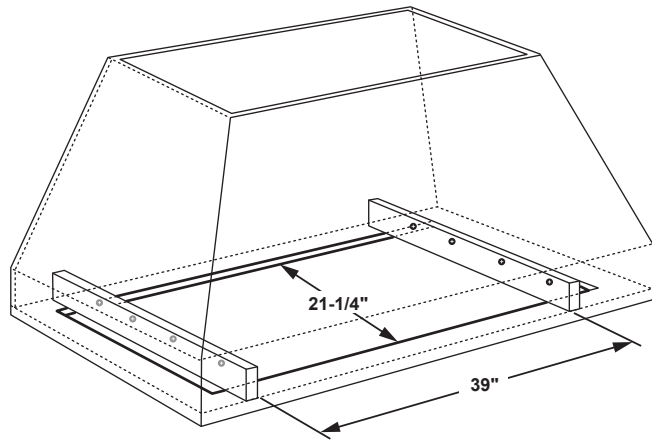
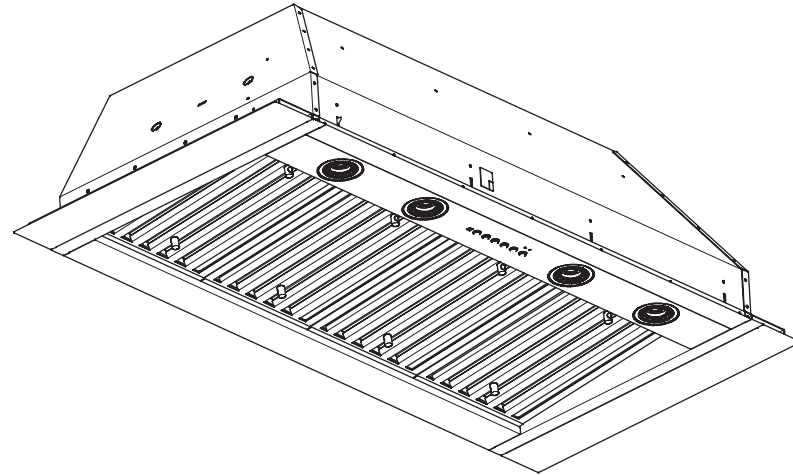

These hoods are secured to the custom cabinet from both sides through 8 screws. Two 2x4 studs separated by 39" need to be provided on the custom cabinets for installation.

Art is showing the cutout dimensions.

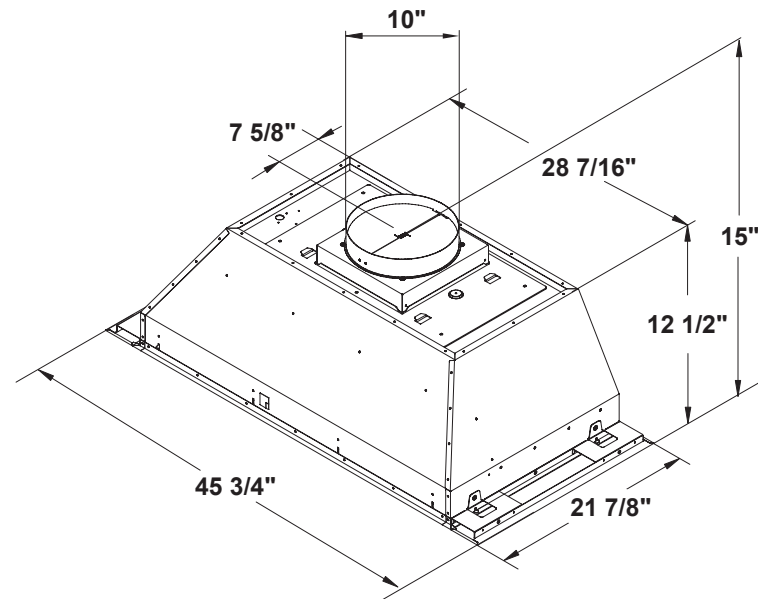

For answers to your Monogram, GE Café™, GE Profile™ or GE Appliances product questions, visit our website at geappliances.com or call GE Answer Center® Service, 800.626.2000.

Specification Revised 11/22

UVC9480SLSS

48" Universal Custom Hood Insert

FEATURES AND BENEFITS

Adjustable CFM blower – Two high powered 610 CFM blowers are capable of delivering 1220 CFM air flow.

Brilliant LED dimmable lighting (bulbs included) – 4 long-lasting LED lights ensure even lighting for the entire cooking environment

Electronic backlit controls – Add a sophisticated look with this up-front, easy-to-use display

Premium Baffle Stainless Steel Filters – removes odors and grease from your cooking area and are easy to clean in your dishwasher

WiFi Connect – Control appliances with a smart device or just the sound of your voice

Chef Connect – Automatically control the hood's lights and fan by syncing with the range

Remote control included – Activate and adjust your hood functions from anywhere in the kitchen

Four-speed fan control – Helps draw smoke, grease, odors and moisture out of the kitchen air

Model UVC9420SLSS – Stainless steel

Model UVC9480SLSS – Stainless steel

