

SGSXP365TS

36-INCH GAS COOKTOP

MASTERPIECE® PEDESTAL STAR® BURNER COLLECTION

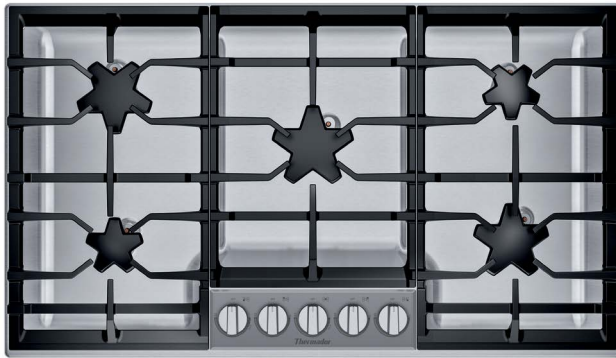

FEATURES & BENEFITS

- ★ - Patented Star® Burner's unique five-point design offers more ports and more flame distribution than a round burner
- ★ - QuickClean Base® with a teardrop emboss reduces food buildup near the base and contains liquid spills for quick cleaning
 - Raised pedestal burner allows a hand or sponge to fit easily under each burner to wipe the surface clean
- ★ - ExtraLow® Select burner with 5 precise settings is perfect for simmering or holding foods and melting chocolate without scorching or burning
- ★ - Progressive illuminated light ring around each knob indicates burners in use

ACCESSORIES (OPTIONAL)



SWOKRINGW
Wok Ring



SGRIDDLEW
Griddle

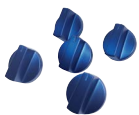

SKNOBLUW
Metallic Blue Knob Kit



SNPKITPEDW
LP Conversion Kit

GENERAL PROPERTIES

Controls	Metal Knobs
Sealed Burners	Yes
Grate Material	Cast Iron

BURNER PERFORMANCE

Total BTU Load (NG / LP)	60,200 / 45,200 BTU
Power of Front Left Burner (NG / LP)	9,100 / 6,000 BTU
Power of Back Left Burner (NG / LP)	12,000 / 9,100 BTU
Power of Center Burner (NG / LP)	18,000 / 15,000 BTU
Power of Back Right Burner (NG / LP)	9,100 / 6,000 BTU
Power of Front Right Burner (NG / LP)	12,000 / 9,100 BTU

TECHNICAL DETAILS

Watts (W)	1,800 W
Circuit Breaker (A)	15 A
Volts (V)	120 V
Frequency (Hz)	60 Hz
Plug Type	3 Prong
Power Cord Length (in)	60"
Energy Source	Gas
Convertible To LP (Kit Required)	Yes

DIMENSIONS & WEIGHT

Overall Appliance Dimensions (HxWxD) (in)	5 3/8" x 37" x 21 1/4"
Required Cutout Size (HxWxD) (in)	3 13/16" x 34 15/16" x 19 1/8"
Minimum Distance From Counter Front (in)	1 1/2"
Minimum Distance From Rear Wall (in)	3"
Net Weight (lbs)	41 lbs

WARRANTY

Limited Warranty, Entire Appliance, Parts and Labor	2 Year
---	--------

†To be fully ADA compliant, these units must be installed according to ADA guidelines. Please check current ADA requirements for guidance on installation.

SGSXP365TS
36-INCH GAS COOKTOP
 MASTERPIECE® PEDESTAL STAR® BURNER COLLECTION



36-INCH COOKTOP AND CUTOUT DIMENSIONS

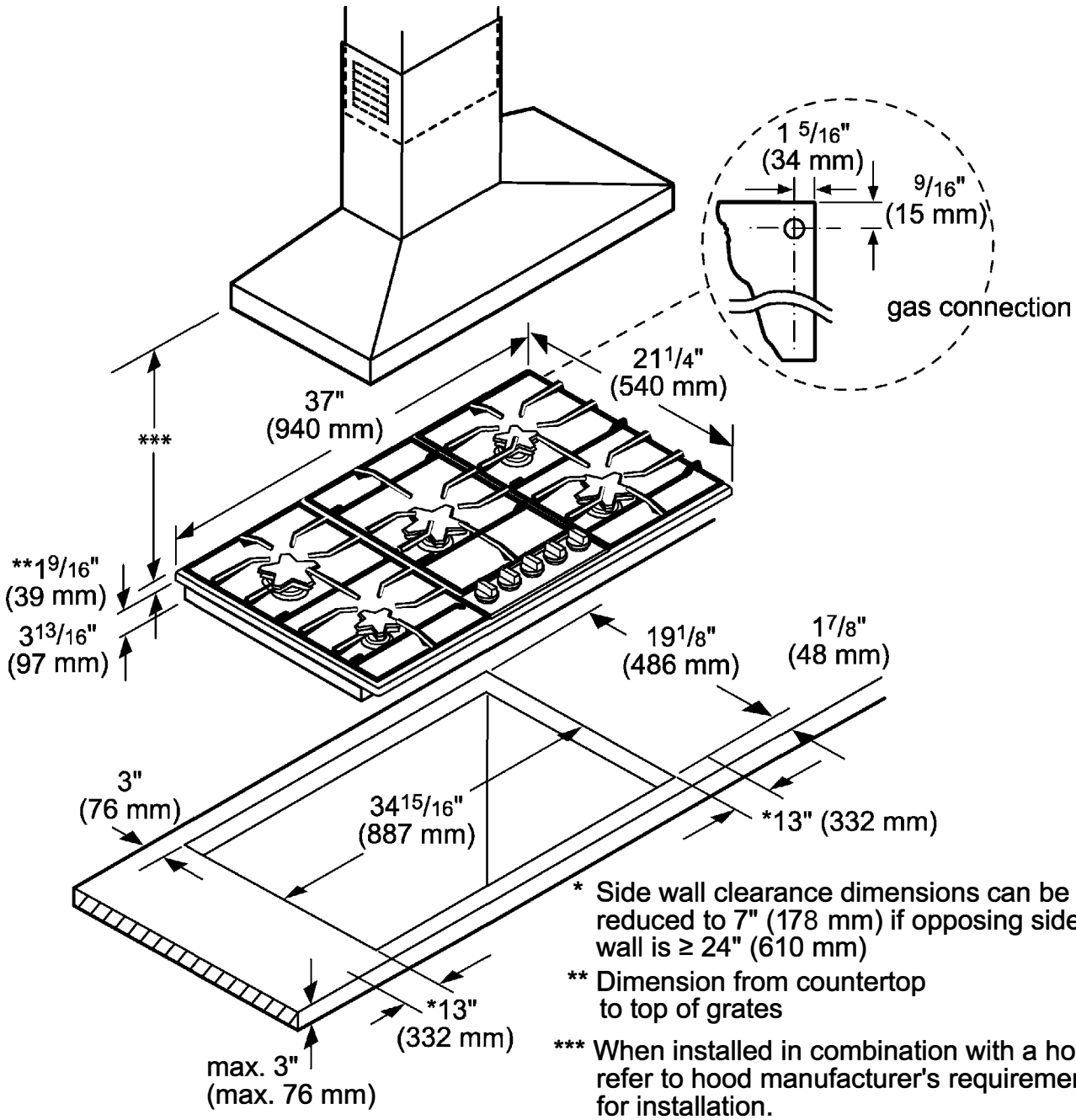

measurements in inches (mm)

SGSXP365TS

36-INCH GAS COOKTOP

MASTERPIECE® PEDESTAL STAR® BURNER COLLECTION



CABINET REQUIREMENTS

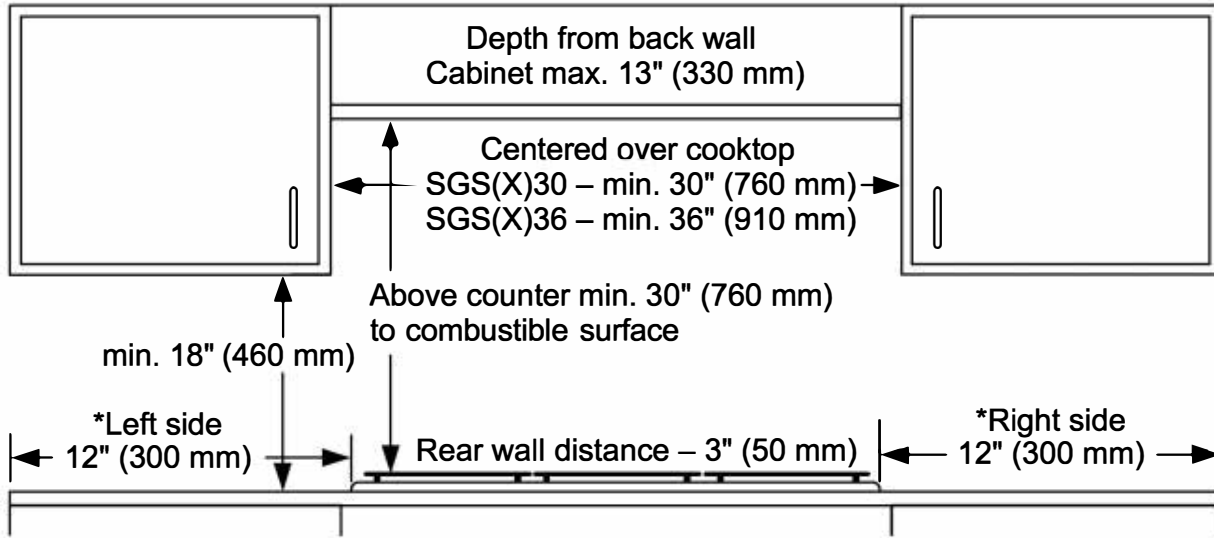

* Side wall clearance dimensions can be reduced to 6" (152 mm) if opposing side wall is ≥ 23" (584.2 mm)

measurements in inches (mm)

INSTALLATION ABOVE A THERMADOR WALL OVEN

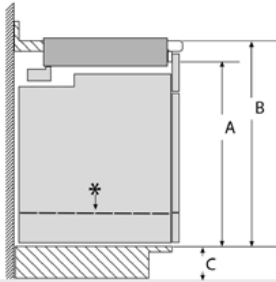

Product Type	A Inches (mm)	B min. Inches (mm)	C max. Inches (mm)
Conventional Oven	28 1/4 (718)	31 1/4 (794) min.	4 3/4 (121)
Steam Oven	25 1/16 (636)	28 1/16 (713)	7 15/16 (202)
Steam Oven with 4" Storage Drawer*	28 1/4 (718)	31 1/4 (794) min.	4 3/4 (121)
Microwave / Speed Oven	19 1/4 (488)	24 (609) min.	12" (306)
Microwave / Speed Oven with Warming drawer*	28 1/4 (718)	31 1/4 (794) min.	4 3/4 (121)

When installing an oven or oven with a drawer in combination with a cooktop, a minimum distance between the cabinet floor and countertop (B) is required. Reference the table for dimensions. Refer to the oven installation guide for all other measurements.

These warranties give you specific legal rights and you may have other rights that vary from state to state. Limited warranty from date of delivery. For complete warranty details, refer to your Use & Care manual, or ask your dealer.

Specifications are for planning purposes only. Refer to installation instructions and consult your countertop supplier prior to making counter opening. Consult with a heating and ventilation engineer for your specific ventilation requirements. For the most detailed information, refer to installation instructions accompanying product or write to Thermador indicating the model number. Specifications are correct at time of printing. Thermador reserves the right to change product specifications or design without notice. Some models are certified for use in Canada. Thermador is not responsible for products that are transported from the U.S. for use in Canada.