

DISHWASHER

MODEL : SDW6767HS



Dishwasher: Model SDW6767HS

CUSTOMER ASSISTANCE	2	GETTING STARTED.....	13
CONSUMER LIMITED WARRANTY.....	3	DISHWASHER CYCLE OPTIONS.....	17
QUICK START GUIDE	4	CARE AND CLEANING	19
IMPORTANT SAFETY INSTRUCTIONS.....	7	TROUBLESHOOTING.....	21
APPEARANCE OVERVIEW	8	ERROR CODES	23
CONTROL PANEL.....	9	DRAIN HOSE INSTALLATION	24
CONVENIENT FEATURES	11		

REGISTER YOUR PRODUCT

Registering your new product is easy and offers benefits that help you get the most out of your Sharp product including:

- ✓ **Convenience:** If you ever need warranty support, your product information is already on file.
- ✓ **Communication:** Stay up to date with important notifications and special offers from SHARP.
- ✓ **Support:** Quickly access support content including Owner's Manuals, FAQ's, How-to Videos, and much more.

3 EASY WAYS TO REGISTER TODAY!

 <p>SCAN Use the camera or QR code scanning application on your smart phone</p>	 <p>ONLINE Visit our sites to learn more about your product at sharpusa.com and sbl.sharpusa.com</p>	 <p>CALL US US 800-BE-SHARP 800-237-4277 Mon-Fri: 7am-7pm CST Sat-Sun: 9am-7pm CST</p>
Scan this QR Code on your smart phone	Visit http://www.sharpusa.com/register	Contact a Sharp Advisor on the phone

PRODUCT SUPPORT



If you have questions about the setup or operation of your product, please refer to the corresponding section within this manual.

Additionally, visit www.sharpusa.com/support to access exclusive content about your product including:

- FAQ's and How-To Videos
- Find or Request Service
- Purchase an Extended Warranty
- Downloads including the Installation Guide, Spec Sheet, and Owner's Manual

CONTACT US

If at any time you have questions or comments concerning your SHARP product, please contact the SHARP Customer Assistance Center. We are available to assist you through multiple contact methods for your convenience:

 <p>EMAIL Available 24/7 US: sharpusa.com</p>	 <p>CHAT ONLINE Mon-Fri: 7am-7pm CST Sat-Sun: 9am-7pm CST</p>	 <p>CALL US US 800-BE-SHARP 800-237-4277 Mon-Fri: 7am-7pm CST Sat-Sun: 9am-7pm CST</p>
See the Contact Us section on our sites	U.S. www.sharpusa.com/support	Contact a Sharp Advisor on the phone

SHARP®

CONSUMER LIMITED WARRANTY

SHARP ELECTRONICS CORPORATION (“Sharp”) warrants to the first consumer purchaser (“Purchaser”) that this SHARP brand SHARP ELECTRONICS CORPORATION warrants to the first consumer purchaser that this Sharp brand product (the “Product”), when shipped in its original container, will be free from defective workmanship and materials, and agrees that it will, at its option, either repair the defect or replace the defective Product or part thereof with a new or remanufactured equivalent at no charge to the purchaser for parts or labor for the period(s) set forth below.

This warranty does not apply to any cosmetic or appearance items of the Product nor to the additional excluded item(s) set forth below nor to any Product the exterior of which has been damaged or defaced, which has been subjected to misuse, abnormal service or handling, or which has been altered or modified in design or construction. In order to enforce the rights under this limited warranty, the purchaser should follow the steps set forth below and provide proof of purchase to the servicer.

The limited warranty described herein is in addition to whatever implied warranties may be granted to purchasers by law. ALL IMPLIED WARRANTIES INCLUDING THE WARRANTIES OF MERCHANTABILITY AND FITNESS FOR USE ARE LIMITED TO THE PERIOD(S) FROM THE DATE OF PURCHASE SET FORTH BELOW. Some states do not allow limitations on how long an implied warranty lasts, so the above limitation may not apply to you.

Neither the sales personnel of the seller nor any other person is authorized to make any warranties other than those described herein, or to extend the duration of any warranties beyond the time period described above on behalf of Sharp. The warranties described herein shall be the sole and exclusive warranties granted by Sharp and shall be the sole and exclusive remedy available to the purchaser. Correction of defects, in the manner and for the period of time described herein, shall constitute complete fulfillment of all liabilities and responsibilities of Sharp to the purchaser with respect to the Product, and shall constitute full satisfaction of all claims, whether based on contract, negligence, strict liability or otherwise. In no event shall Sharp be liable, or in any way responsible, for any damages or defects in the Product which were caused by repairs or attempted repairs performed by anyone other than an authorized servicer. Nor shall Sharp be liable or in any way responsible for any incident or consequential economic or property damage. Some states do not allow the exclusion of incidental or consequential damages, so the above exclusion may not apply to you.

THIS WARRANTY GIVES YOU SPECIFIC LEGAL RIGHTS.

YOU MAY ALSO HAVE OTHER RIGHTS WHICH VARY FROM STATE TO STATE.

Your product model number & description	Model # SDW6767HS Dishwasher. (Be sure to have this information available when you need service for your Product.)
Warranty period for this product:	One (1) year parts and labor, including in-home service. Five (5) year parts only, racks and electronic controls.
Additional item(s) excluded from warranty coverage:	Commercial, non-residential, or use inconsistent with published installation and product operational instructions. In home instruction on how to use your product.
What to do to obtain service:	In-home service eligibility is calculated from date of purchase. Service can be arranged by calling 1-800-BE-SHARP. Be sure to have Proof of Purchase, Model, and Serial Number available.

TO OBTAIN SUPPLY, ACCESSORY OR PRODUCT INFORMATION, CALL 1-800-BE-SHARP or visit www.sharppusa.com.
SAVE THE PROOF OF PURCHASE AS IT IS NEEDED SHOULD YOUR DISHWASHER EVER REQUIRE WARRANTY SERVICE.

WI-FI CONNECTIVITY INSTRUCTIONS

WI-FI SPECIFICATIONS

Wireless LAN: IEEE802.11b/g/n

Frequency range: 2.4GHz frequency band

There are three different ways to connect your dishwasher to Amazon Alexa. First, download the Amazon Alexa app, then connect your Dishwasher to Wi-Fi using one of three methods: With a Barcode, Without a Barcode and Zero Touch Setup. Next, you need to enable Remote Command & Control.

Step 1: Wi-Fi Connection

Option 1: With a Barcode

- 1 Touch **Power** to turn on the dishwasher, then touch and hold **Rinse Only** and **Hi Temp Wash** together for 5 seconds until "FR" appears on the display.

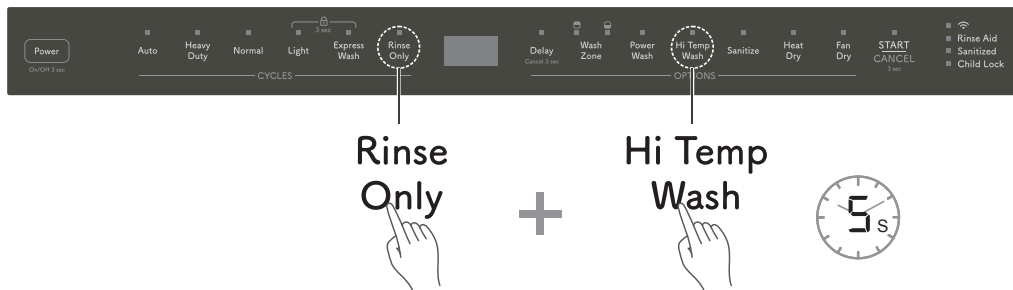

- 2 Open the Amazon Alexa app, select **Devices** and touch + to add a device. Select the type of device and follow instructions to scan the barcode located on the right side of the inner part of the door.

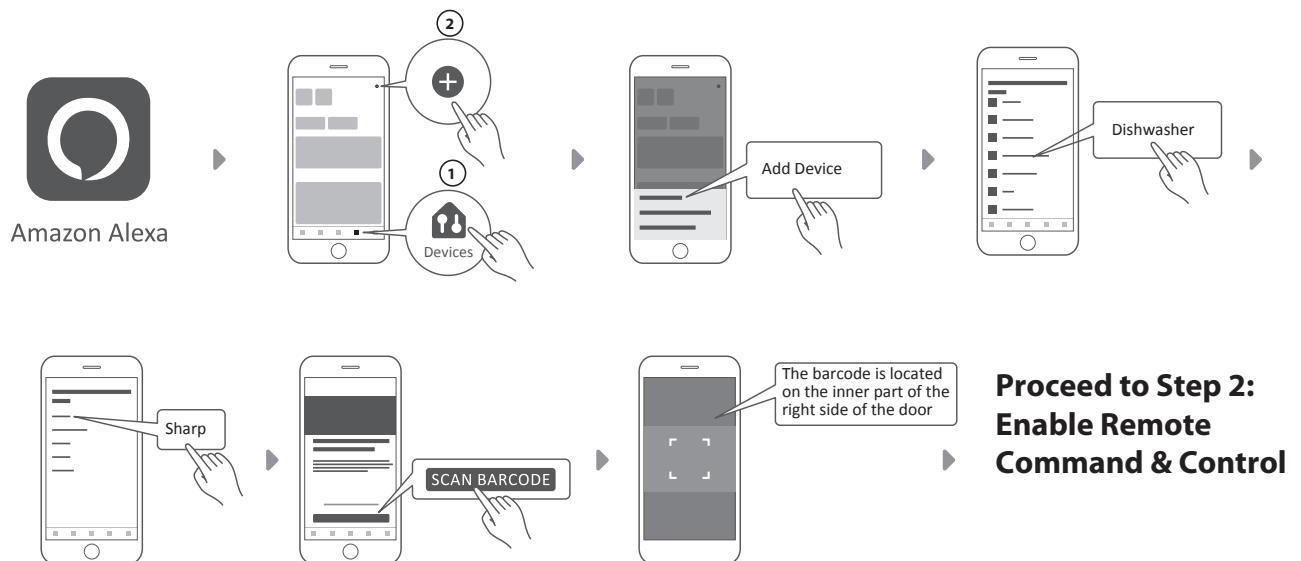

WI-FI CONNECTIVITY INSTRUCTIONS

Option 2: Without a Barcode

- 1 Touch **Power** to turn on the dishwasher, then touch and hold **Rinse Only** and **Wash Zone** together for 5 seconds until "UG" appears on the display.

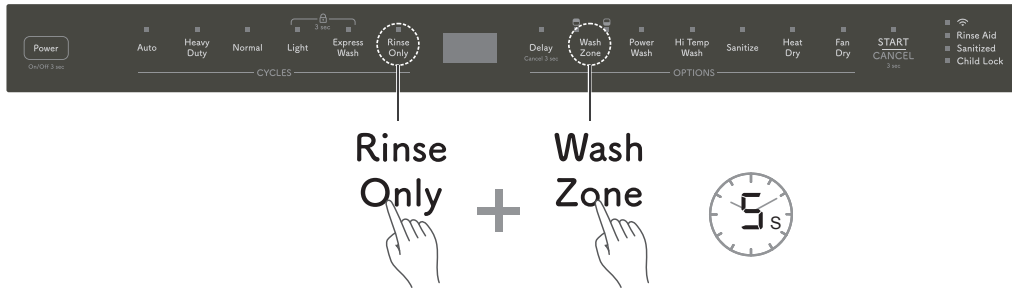

- 2 Open the Amazon Alexa app, select **Devices** and touch + to add a device. Select the type of device, then select **DON'T HAVE A BARCODE?** and touch **NEXT**.

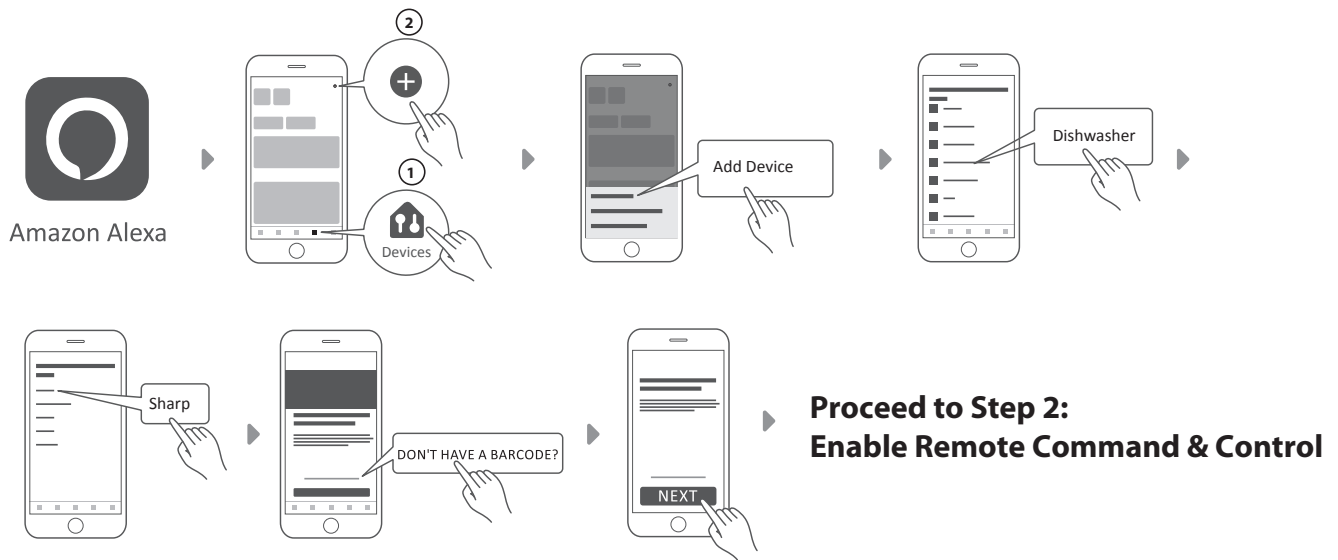

Option 3: Zero Touch Setup

Zero Touch Setup is only available if your dishwasher was purchased through Amazon.com and Zero Touch Setup was applied to your personal Amazon account during checkout.

Touch **Power** to turn on the dishwasher. Open the Amazon Alexa app, and it will automatically pair to your Dishwasher.

An active Echo Dot (2nd Gen or later) can also perform Zero Touch Setup.

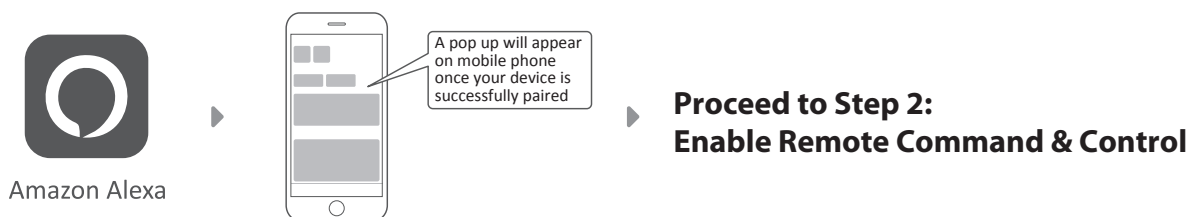

WI-FI CONNECTIVITY INSTRUCTIONS

Step 2: Enable Remote Command & Control

With the Dishwasher connected to Wi-Fi and paired to the mobile app, authorize your appliance to accept control commands from your mobile app or voice commands.

To start the network control, touch and hold **Rinse Only** and **START/CANCEL** together for 5 seconds until the Wi-Fi indicator stops flashing and remains lit.

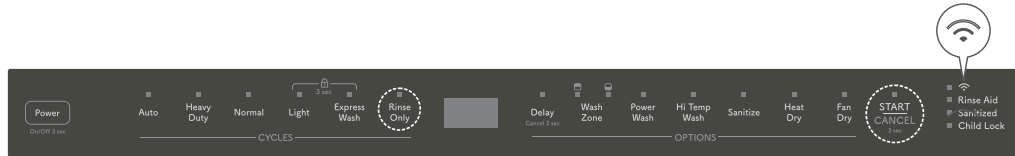

Rinse
Only



START
CANCEL

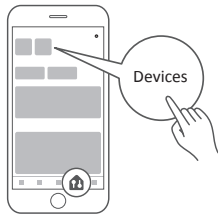

You have successfully connected the dishwasher and enabled remote command and control. Access your Dishwasher on the **Devices** tab in the Amazon Alexa app.

IMPORTANT SAFETY INSTRUCTIONS

⚠WARNING Follow these safety instructions to minimize the risk of fire, explosion, electric shock, property damage and/or personal injury.

PROPER INSTALLATION

Follow this guide to install your dishwasher properly.

- 1 Water supply inlet temperature should be between 120°F and 149°F.
- 2 Dispose of the discarded appliance and packing material properly.
- 3 The dishwasher must be properly grounded to avoid a risk of electric shock.
- 4 If there is any damage to the dishwasher, please contact your dealer. Do not attempt to repair or replace any part by yourself.

BASIC PRECAUTION BEFORE USE

The manual does not cover every possible condition and situation that may occur.

- 1 Read all instructions before using the dishwasher.
- 2 Use the dishwasher only for intended function as described in this manual.
- 3 When loading items to be washed:
 - Load sharp items and knives so they are not likely to damage the door seal and tub.
 - Load sharp items and knives with the handles up to reduce risk of injury.
- 4 Do not wash plastic items unless they are marked dishwasher safe. If not marked, check with manufacturer for recommendation. Items that are not dishwasher safe may melt and create a potential fire hazard.

- 5 If the dishwasher drains into a food disposer, ensure the disposer is completely empty before running dishwasher.
- 6 Do not tamper with controls.
- 7 Do not operate the dishwasher unless all enclosure panels are in the proper place.
- 8 Do not touch the heating element during or immediately after use, especially if the sanitize option has been selected.
- 9 Do not allow children to play in or on the dishwasher.
- 10 Do not let children abuse, sit or stand on door or racks of the dishwasher.
- 11 Keep young children and infants away from dishwasher when it is in operation.
- 12 If the hot water system has not been used for two weeks or longer, BEFORE USING DISHWASHER turn on all hot water faucets and let water run for several minutes to release any accumulated hydrogen gas. Under certain conditions, hydrogen gas may be produced in a hot water system not in use for two weeks or longer.

⚠WARNING HYDROGEN GAS IS EXPLOSIVE AND FLAMMABLE. DO NOT smoke or use an open flame while releasing hydrogen gas.

- 13 Do not store or use combustible materials, gasoline or other flammable vapors and liquids in the vicinity of this or any other appliance.
- 14 Use only detergents or rinse agents recommended for use in a dishwasher and keep them out of the reach of children.
- 15 Do not use the dishwasher if it has a damaged power line or plug and do not plug the dishwasher into a damaged outlet. Failure to observe these instructions may result in electric shock.

SAVE THESE INSTRUCTIONS

APPEARANCE OVERVIEW

PACKAGE CONTENTS

- Dishwasher
- Drain Hose
- Installaiton kits
(4 wood screws, 2 top mounting clip, 1 hose clamp)
- Operation Manual
- Installation Instructions
- Energy Guide
- Extended Warranty

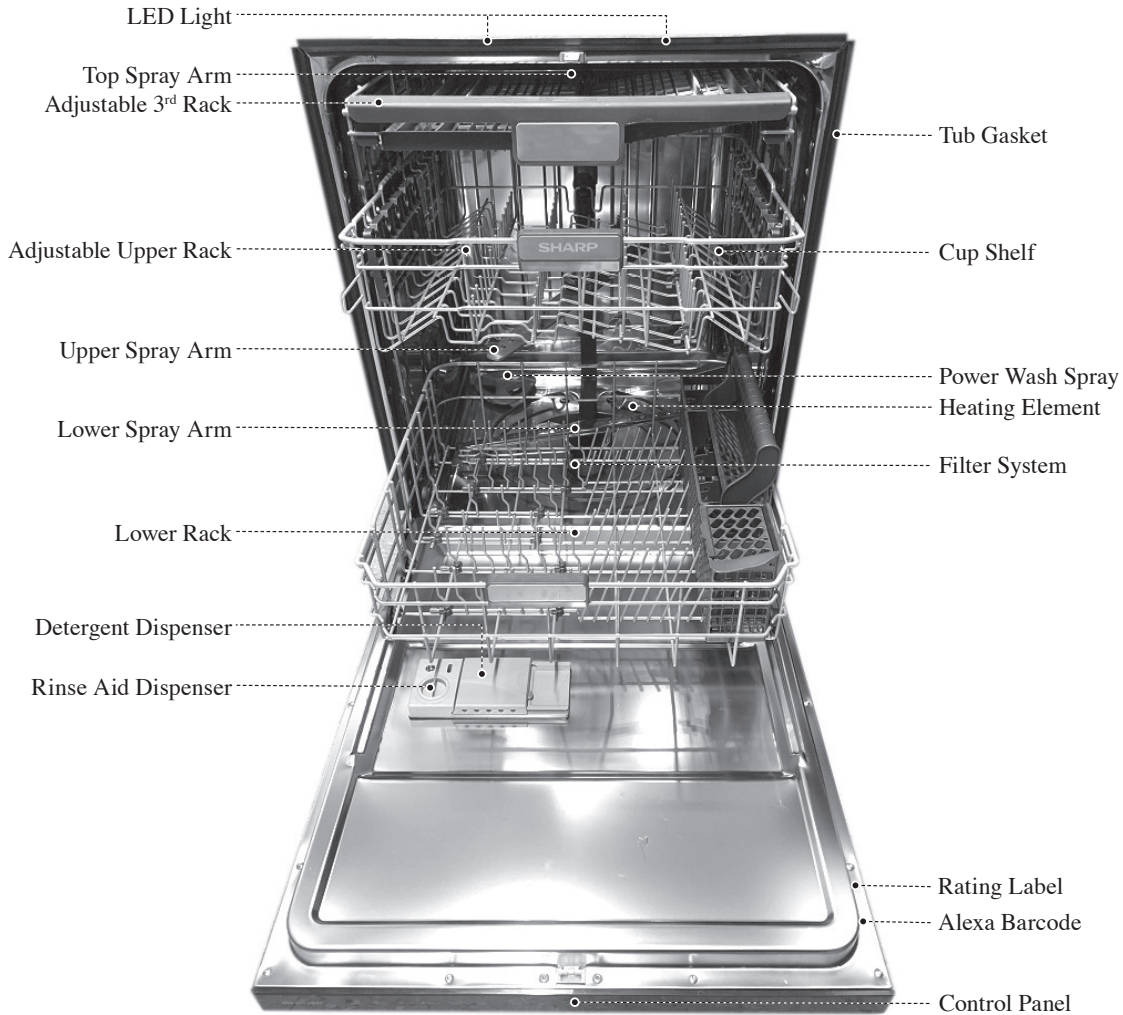

SPECIFICATION

Capacity	14 place settings
Dimension (W x D x H)	23 7/8" x 24 1/2" x 33 7/8" (606 x 622 x 858 mm)
Weight	Unpacked 93.3 lb (42.3 kg)
Power Supply	120 volts, 60 Hz
Rated Power Usage	Wash motor 50 W / Heater 840 W
Water Feed Pressure	20 ~ 120 psi (138 ~ 828 kPa)
Current	8.4 A
Noise (dB)	45 dB

CONTROL PANEL

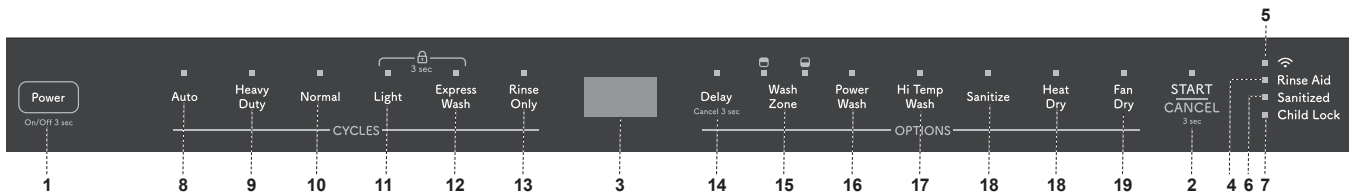

Control Panel is located on the top edge of the door.
The door must be opened to select settings and operate the dishwasher.

OPERATIONS & DISPLAYS

1 Power

Touch the Power pad and hold for 3 seconds to turn power On/Off.

2 START/CANCEL

To run the dishwasher, open the door and select desired wash cycle. The indicator light will turn on. Touch the START/CANCEL pad and close the door within 4 seconds. The selected wash cycle light will begin to blink, and the cycle progress indicator will turn on, indicating the wash cycle is running.

NOTE: If the door is not closed within 4 seconds of touching START/CANCEL, the cycle will time out, and the dishwasher will not start.

- To modify or change a selected running wash cycle, open the door, touch the START/CANCEL pad and hold for 3 seconds. The dishwasher will drain the water for 60 seconds, and the screen will display “0:01” after draining has completed. You may select a new cycle at this time.
- To pause the running dishwasher to load more dishes, USE CAUTION and open the door slowly to avoid injury by hot steam from inside the dishwasher. If the detergent dispenser is still closed, indicating the main wash cycle has not started, you may add more dishes to the dishwasher.
- To achieve the best washing results, it is strongly recommended that all dishes be loaded before washing cycle begins.

3 Display Window

Displays the remaining hours and minutes of the running cycle, delay hours, error codes, etc.

4 Rinse Aid Indicator Light

When the dishwasher requires additional rinse aid, the indicator light will be on.

5 Wi-Fi Indicator Light

When the network link is successful, the indicator light will be on.

6 Sanitized Indicator Light

When a cycle with the sanitize function finishes, the indicator light will be on. When the door is opened, the indicator light will turn off after 30 seconds. The sanitize cycle is NSF certified.

7 Child Lock Indicator Light

When the Child Lock function is selected, the indicator light will be on.

- To lock all controls and prevent children from operating or changing the dishwasher, touch the Light pad and the Express Wash pad simultaneously. To cancel the Child Lock function, repeat this process.

WASH CYCLE SELECTIONS

8 Auto

This cycle detects the turbidity degree and loading level of the washing items and automatically selects an optimal wash cycle for best performance.

9 Heavy Duty

This cycle is for hard-to-clean, heavily soiled dishes, pots and pans.

10 Normal

This cycle is for commonly used, moderately soiled dishes and silverware and has energy and water-saving benefits.

11 Light

This cycle is for lightly to moderately soiled china and crystal.

12 Express Wash

This cycle is for lightly soiled, pre-rinsed dishes and silverware.

13 Rinse Only

This cycle is for pre-rinsing dishes or glassware. The Rinse Only cycle keeps food from drying on dishes and reduces odor buildup before running a full load. Do not use detergent.

OPTIONS

14 Delay

To delay the start of a selected cycle, touch the Delay pad until the desired delay time shows in the LED display. This allows you to automatically start your dishwasher with 1 to 24 hours delay. To cancel the Delay Start option and begin the cycle before the delay period is over, touch the START/CANCEL pad.

15 Wash Zone

To select upper, lower or both racks to wash, touch Wash Zone. This option is not available in Auto and Rinse Only cycles.

CONTROL PANEL

16 Power Wash

Use this option to wash pots, pans, durable serving bowls and other large, heavily soiled or hard-to-clean dishes. To use Power Wash, place the dishes facedown in the lower rack directly above the power wash arm in the back left corner and touch Power Wash pad.

17 Hi Temp Wash

When the Hi Temp Wash function is selected, the temperature of the water will be maintained at 140°F (60 °C) maximum.

18 Sanitize

To sanitize dishes and glassware, touch the Sanitize pad. When the Sanitize function is selected, the temperature of the water will be maintained at 158°F (70 °C) maximum.

NOTE: It is possible that 158°F (70 °C) may not be reached if the water supply inlet temperature is lower than recommended.

19 Heat Dry

When the Heat Dry function is selected, the heater will operate during the drying process.

20 Fan Dry

When the Fan Dry option is selected, two fan operations will create an airflow within the dishwasher cavity and help accelerate the drying process.

DISPLAY WINDOW

DELAY TIME

If the Delay option is selected, the number of Delay Start hours will display in the Display Window.

While the dishwasher is running, if the remaining cycle time exceeds an hour, the remaining number of hours and minutes will alternate in the Display Window. One hour is displayed as H:01.

CYCLE LIGHT

When a wash cycle is programmed and the START/CANCEL pad is touched, the Cycle Light will flash. The Cycle Light also flashes if the door is opened during a wash cycle. Close the dishwasher door to begin or continue the wash cycle.

SMART SENSOR

The remaining time may increase or decrease as the Smart Sensor assesses the soil level and adjusts the number of water fills required for the load.



ERROR INDICATION

In certain situations that are critical to the safe function and operation of the dishwasher, the machine will shut down and display an error code. See Error Codes on page 23.

If error codes are displayed, contact the dealer or servicer to provide assistance in troubleshooting the problem or locate an authorized service technician if needed.

CYCLE PROGRESS INDICATOR

The cycle progress lights indicate the progress of the cycle while the dishwasher is running. They are located on the front of the dishwasher panel on the right side of the pocket handle.

PROCESS	INDICATOR
WASH When the dishwasher is in a wash or rinse stage of a cycle, the WASH light is illuminated.	
DRY When the dishwasher is in a drying stage of a cycle, the WASH and DRY lights are illuminated.	
CLEAN When the dishwasher completes all stages of a cycle, all indicator lights are illuminated. If the door is opened when the CLEAN lights are illuminated, all the lights will turn off after 30 seconds.	

DART SERVICE INFORMATION

AMAZON DASH REPLENISHMENT:

Amazon Dash Replenishment is a tool that you can add to your dishwasher to make reordering dish detergent tablets and rinse aid easy. You can track supply levels within the Alexa app, receive notifications from Alexa when your dish detergent tablets, or rinse aid is running low, and smart reorder quickly and easily from Amazon when needed.

To access your Dash Replenishment information and settings, select Settings in the upper right corner of your device control screen, and then select “Dishwasher Detergent/Rinse Aid – Notification and Reorder Settings”.

CONVENIENT FEATURES

LED LIGHTS

When the door is opened, the two LED lights on the top of the tub will automatically turn on.



ADJUSTABLE UPPER RACK

The Upper Rack height can be raised or lowered to accommodate loading taller dishes in either rack. The Upper Rack clearance height is 8" to 10". The Lower Rack clearance height is 11" to 13".

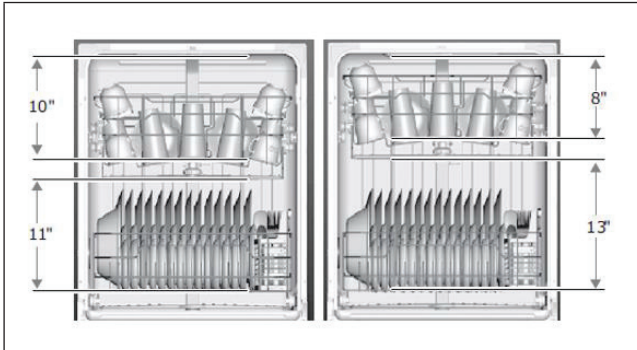

ADJUSTABLE 3RD RACK

Use the Adjustable 3rd Rack for cutlery or other utensils. When space is needed for the Upper Rack, slide the right shelf of the Adjustable 3rd Rack over the left shelf.

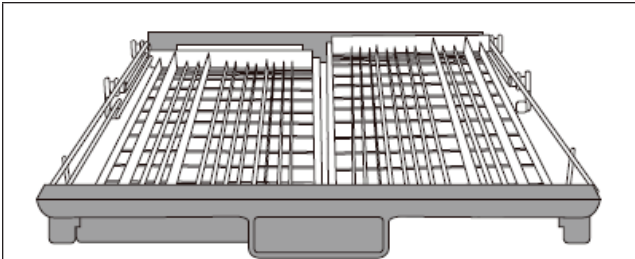

Lift the right basket up to make both left and right baskets are flat.

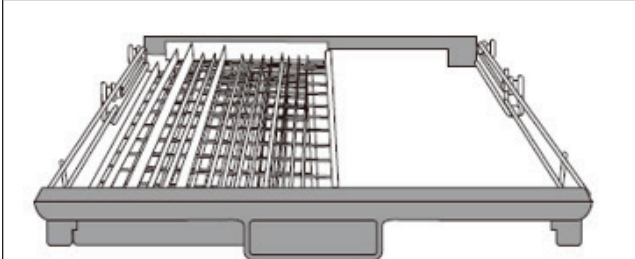

Move the right basket from right to left, and two baskets are overlapping.

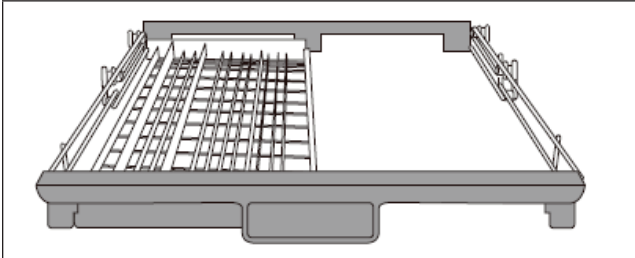

Remove the right basket from the tray, and the left basket remains.

To adjust the Upper Rack position, lift the Adjustment Arms on both sides of the rack and pull up or push down the rack.

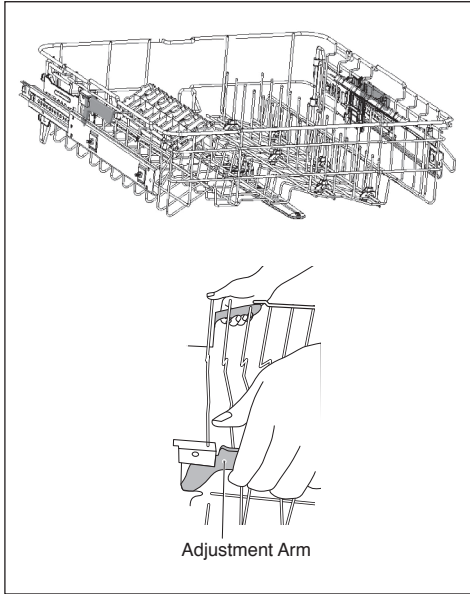

Adjustment Arm

! Height should be adjusted without dishes in the racks.

CONVENIENT FEATURES

FOLDABLE TINES

The upper and lower racks include flexible tines that can be folded down to create more space for dishes. The tines may be left in the up position for normal use or folded down for more flexible loading.

TO FOLD TINES DOWN

Grasp the tip of the tine, gently pull the tine out of the tine holder and rotate the tine to the side.

- Upper Rack - Push the tines to the center of the rack.
- Lower Rack - Push the tines to the back of the rack.

TO STAND TINES UPRIGHT

Grasp and pull the tine until it is vertical and/or it clicks into place. Verify the tines are secure before loading.

- Upper Rack - Push the tines to the right-hand side of the rack.
- Lower Rack - Push the tines to the front of the rack.

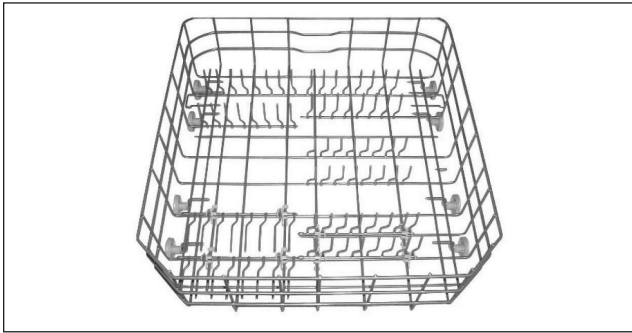

FILTER SYSTEM

The multiple filter system has four mesh filters that separate soiled water and clean water into different chambers to help the dishwasher run well, using less water and energy.

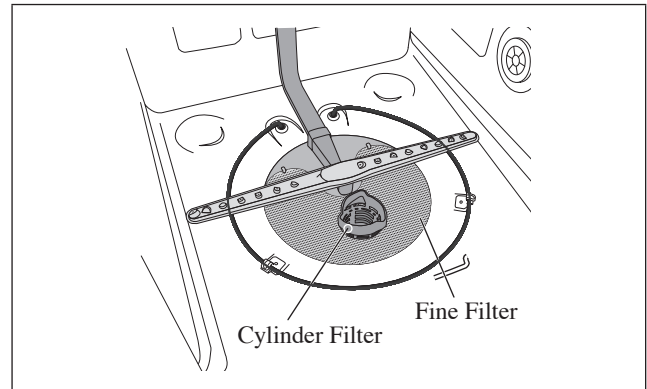

SMART WASH SYSTEM

The Smart Wash System determines the type of cycle required to clean the dishes in the load with maximum efficiency. When a partial load of lightly soiled dishes is placed in the unit, a wash cycle similar to a short wash will automatically run. When a full load of heavily soiled dishes is placed in the unit, a heavy wash cycle will automatically run.

POWER WASH SPRAY

The Power Wash Spray works with the upper spray arm and the lower spray arm to effectively wash heavily soiled pots and pans. It is located in the back left corner.

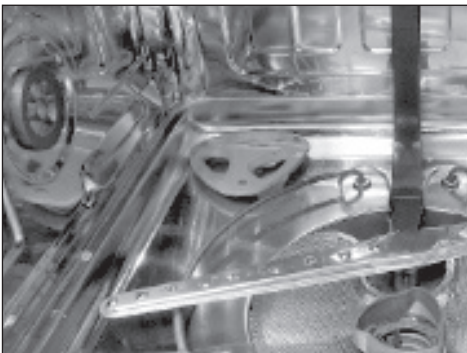

GETTING STARTED

HOW YOUR DISHWASHER CLEANS

Your dishwasher cleans by spraying a mixture of hot water and detergent through the spray arms against soiled surfaces.

The dishwasher fills with water, covering the filter area. Water is then pumped through the multiple filter system and spray arms. Separated soil particles go down the drain as the water is pumped out and replaced with clean water.

The number of water fills will vary depending on the cycle.

BASIC OPERATIONS

- 1 Load dishwasher. (See Dish Preparation below.)
- 2 Add detergent. (See Filling the Detergent Dispenser, page 16.)
- 3 Add rinse aid if needed. (See Filling the Rinse Aid Dispenser, page 16.)
- 4 Select desired cycle. (See Cycle Chart, pages 17–18.) The indicator light above the pad will turn on when selected.
- 5 Select desired options. The indicator light above the pad will turn on when selected.
- 6 To start, touch the START/CANCEL pad.
- 7 Close the door within 4 seconds to begin the cycle.

Your dishwasher has the top control panel.

Your selections will only be activated when the door is firmly closed.

NOTE: The dishwasher is programmed to remember your last cycle so you do not have to reset each time. To start the dishwasher using the same cycle and options selected on the previous wash, simply touch the START/CANCEL pad.

DISH PREPARATION

Before loading dishes into the dishwasher, dispose of large pieces of food, bones, pits, toothpicks, etc.. The continuous filtered wash system will remove the remaining food particles. Burned-on foods should be loosened before loading. Empty liquids from glasses and cups.

Foods such as mustard, mayonnaise, vinegar, lemon juice and tomato-based products may cause discoloration of stainless steel and plastics if allowed to sit for long periods of time. If not operating the dishwasher immediately, it is best to rinse dishes soiled with these types of foods.

If the dishwasher drains into a food disposer, ensure disposer is completely empty before starting dishwasher.

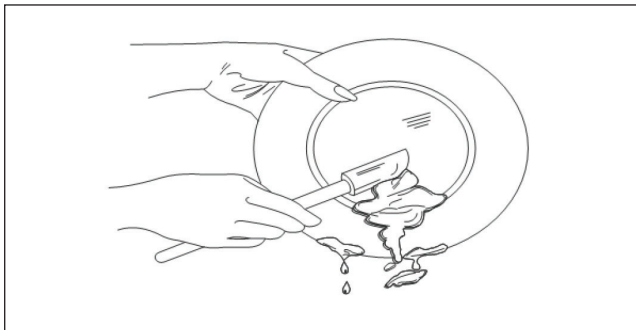

LOADING THE UPPER RACK

The Upper Rack is designed for cups, glasses, small plates, bowls and plastic items marked dishwasher safe.

For best results, place bowls, cups, glasses and sauce pans with soiled surfaces facing down or toward the center. Tilt dishes slightly for better drainage.



Ensure loaded dishes do not interfere with the rotation of the upper spray arm on the bottom of the Upper Rack. To check, rotate the spray arm by hand after loading the rack.



8 plate settings

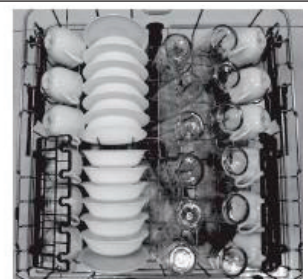

12 plate settings

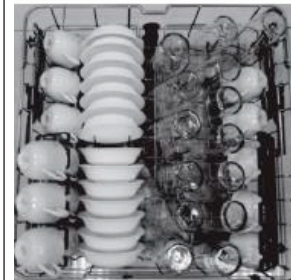

14 plate settings

GETTING STARTED

LOADING THE LOWER RACK

The Lower Rack is designed for plates, soup bowls, saucers and cookware with 13" maximum height.



Large items should be placed along the edge to avoid interference with the upper spray arm rotation or prevent the detergent dispenser from opening. Large items should be turned over so the inside faces downward so the inside faces downward to avoid interference with the lower spray arm.

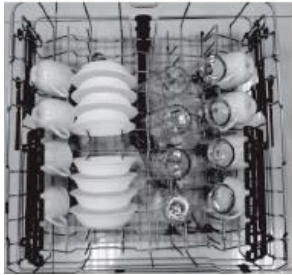

8 plate settings

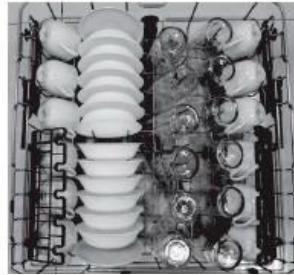

12 plate settings

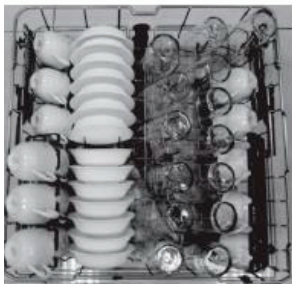

14 plate settings

LOADING THE ADJUSTABLE 3RD RACK

Use the Adjustable 3rd Rack for cutlery or other utensils, such as spatulas or cooking spoons. Silverware, knives and utensils should be loaded separate from each other in the appropriate positions in the third rack so they do not nest together.

NOTES:

- Do not load silver or silver-plated silverware with stainless steel. These metals can be damaged by contact with each other during washing.
- Some foods (such as salt, vinegar, milk products, fruit juices, etc.) can pit or corrode silverware.
- **DO NOT WASH ALUMINUM COOKWARE IN YOUR DISHWASHER.**

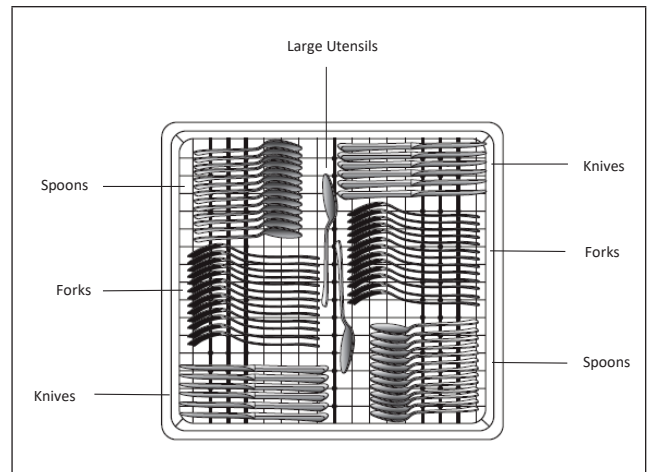

GETTING STARTED

LOADING THE SILVERWARE BASKET

The silverware basket consists of three separate sections. For optimum loading flexibility, the center section of the basket can be used individually, joined with one or both side sections or removed.

- Lift handle to remove the silverware basket and set the basket on a counter or table top.
- Lift up on each side section to disengage the center section from the keyhole slots in the side sections.
- Load silverware into the basket while it sits on the counter or replace the basket into the Lower Rack and load silverware there.

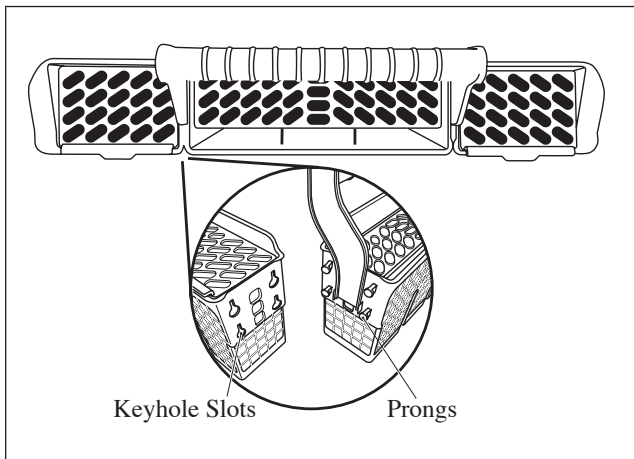

The three separated sections of the silverware basket can be used in both Upper and Lower Racks.

- | | | |
|----------|---------------|----------------|
| 1 Spoons | 3 Salad forks | 5 Large spoons |
| 2 Knives | 4 Forks | 6 Large forks |

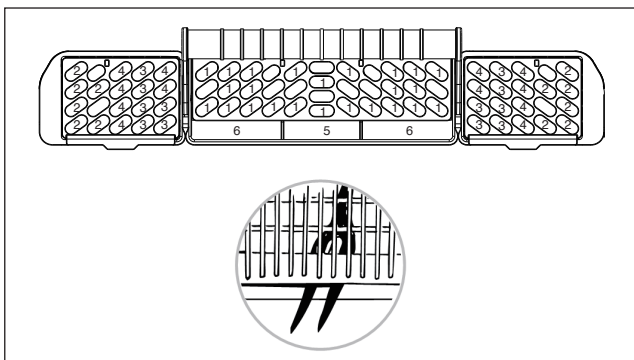

- Do not let any item extend through the bottom.
- Ensure nothing protrudes through the bottom of the silverware basket or rack that could block the lower spray arm.
- Always load sharp items (knives, skewers, etc.) pointing down.

FOR BEST RESULTS:

- To avoid injury, load utensils such as knives and skewers with handles pointing up and sharp metal edges pointing down. Items such as forks and spoons may be loaded with handles pointing up or down, using separators to prevent the edges of the silverware from nesting.
- Place small items such as baby bottle caps, jar lids, corncob holders, etc. in the basket sections with hinged covers. Close the covers to hold small items in place.
- Unload or remove the baskets before unloading the racks to avoid water droplets falling on the silverware.
- When handles are up, mix items in each section of the baskets with some pointing up and some down to avoid nesting. Spray cannot reach nested items.

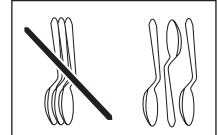

ADDING A DISH

To add or remove items after wash cycle starts:

CAUTION TO AVOID BURN INJURY: Slightly open door and wait until spray arms and wash action stop. Hot steam may exit the dishwasher or hot water may splash out of it. Failure to USE CAUTION may result in injury.

- 1 Open door slightly and wait a few seconds until wash action stops before completely opening.
- 2 If the detergent dispenser is still closed, indicating the main wash cycle has not started, you may add more dishes to the dishwasher.
- 3 Touch the START/CANCEL pad, and close the door latch firmly within 4 seconds. The cycle will automatically resume.

If the door is not closed within 4 seconds after touching START/CANCEL, the cycle will time out and not start.

RINSE AID

Rinse aid greatly improves drying and reduces water spots and filming. Without rinse aid, your dishes and dishwasher interior will have excessive moisture. The Heat Dry option will not perform as well without rinse aid. The Rinse Aid Dispenser, located next to the Detergent Dispenser, automatically releases a measured amount of rinse aid during the final rinse.

If spotting and poor drying are a problem, increase the amount of rinse aid dispensed by rotating the dial to a higher number. The dial is located under the dispenser cap.

If the rinse aid is low, the Rinse Aid Light is illuminated at the beginning and end of the cycle indicating that it is time to refill.

GETTING STARTED

FILLING THE RINSE AID DISPENSER

 Your dishwasher is designed to use a liquid rinse aid. Do not use a solid or bar-type rinse aid. Under normal conditions, the rinse aid will last approximately one month. Try to keep the reservoir full, but do not overfill.

1 Turn the dispenser cap to the left and lift it out.

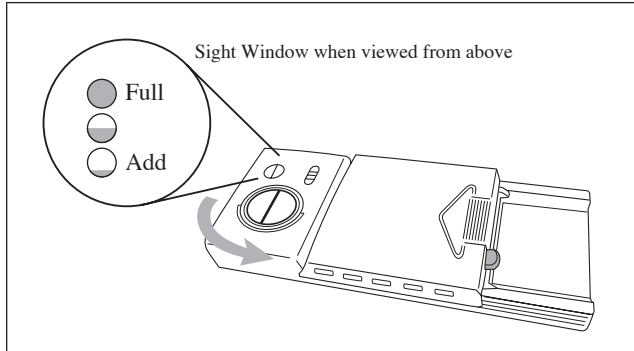

2 Add rinse aid up to the maximum indicator level.

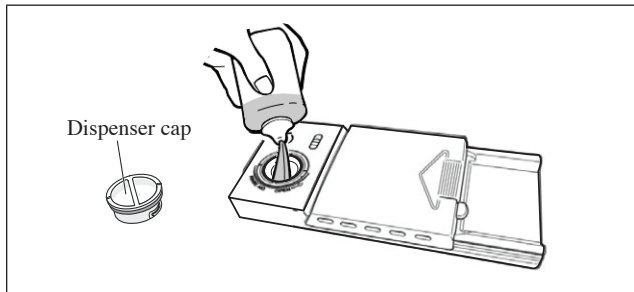

3 You can adjust the amount of the rinse aid released during the rinse operation. A higher number indicates a larger amount of rinse aid released. If dishes are not drying or are spotted, adjust the dial to the next higher setting. If the dishes have sticky, whitish stains, or if glassware or knife blades have a bluish film, adjust the dial to a lower setting.

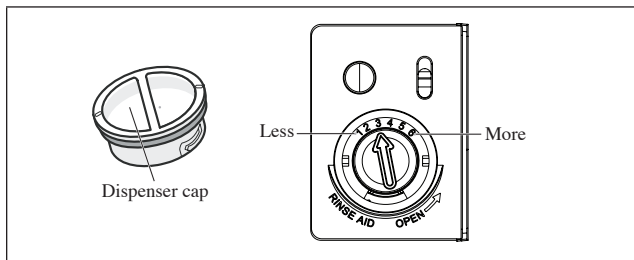

4 Replace the dispenser cap.

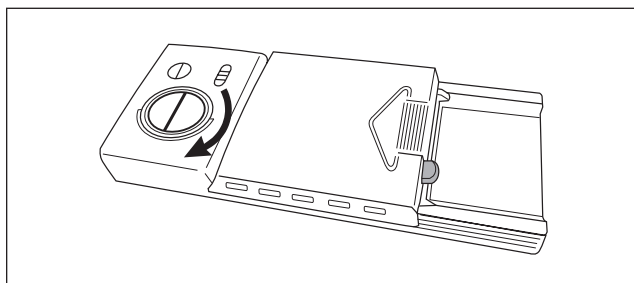

HEAT DRY FUNCTION

The Heat Dry function is used with rinse aid to enhance drying performance. If Heat Dry is not selected, items in the load may not be completely dry at the end of the cycle.

FILLING THE DETERGENT DISPENSER

1 Push the dispenser cover latch downward and open it.

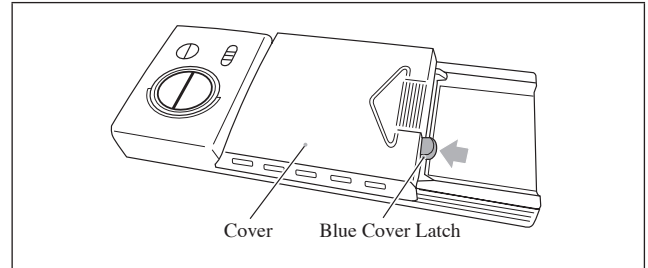

2 Add the detergent to the main wash compartment.

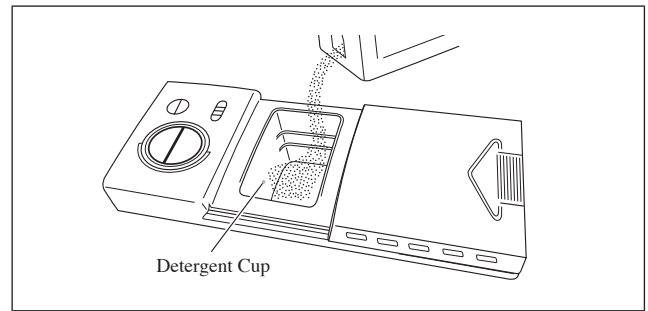

3 Close the dispenser cover.

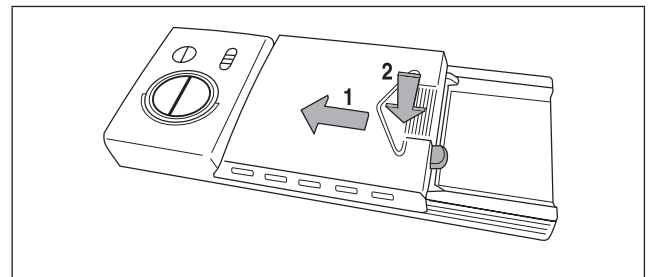

DISHWASHER CYCLE OPTIONS

CYCLE CHART

Select a cycle based on the type of dishes to be washed and the level of soil on the dishes.

Cycle times are approximate and will vary with options selected. The timer will be delayed to allow for the water to heat for the main wash of all cycles if the sensor detects the water is not hot enough. The chart below indicates water use and cycle times under standard conditions.

PROGRAM	DESCRIPTION OF CYCLE	PRE-WASH/MAIN WASH DETERGENT - OZ (G)	WATER - GAL (L)	CYCLE TIME - MIN
AUTO	Pre-Wash	CU: 0.5/0.5 (1.5/1.5) Others: 0/0.3 (0/9.9)	3.0–5.9 (11.4–22.5)	90–121
	Wash 118°F–126°F (48°C–52°C)			
	Rinse 136°F (58°C)			
	Dry			
HEAVY DUTY	Pre-Wash	0/0.7 (0/19.8)	6.9 (26.2)	134
	Wash 131°F (55°C)			
	Rinse 144°F (62°C)			
	Dry			
NORMAL	Pre-Wash	AHM, NSF: 0.7 (19.8) CU: 0.5/0.5 (15/15) DOE: 0/0.3 (0/9.9)	3.0–5.9 (11.4–22.5)	96–116
	Wash 108°F–126°F (42°C–52°C)			
	Rinse 136°F–144°F (58°C–62°C)			
	Dry			
LIGHT	Pre-Wash	0/0.7 (0/19.8)	5 (18.8)	106
	Wash 122°F (48°C)			
	Rinse 118°F (58°C)			
	Dry			
EXPRESS WASH	Pre-Wash 104°F (40°C)	0/0.7 (0/19.8)	4 (15.5)	60
	Wash 131°F (55°C)			
	Rinse 131°F (55°C)			
	Rinse 136°F (58°C)			
	Dry			
RINSE ONLY	Rinse Only	0	2 (7.7)	20

DISHWASHER CYCLE OPTIONS

CYCLE TIME WITH OPTIONS

PROGRAM	DESCRIPTION OF CYCLE	CYCLE TIME W/O OPTIONS	WASH ZONE	POWER WASH	HI TEMP WASH	SANITIZE	HEAT DRY	FAN DRY
		MINUTES						
AUTO	Pre-Wash	90–121	N.A.	N.A.	116–148	123–158	108–145	165–202
	Wash 118°F–126°F (48°C–52°C)							
	Rinse 136°F (58°C)							
	Dry							
HEAVY DUTY	Pre-Wash	134	153	158	163	166	158	208
	Wash 131°F (55°C)							
	Rinse 144°F (62°C)							
	Dry							
NORMAL	Pre-Wash	90–116	117–136	120–140	126–142	134–148	120–140	177–197
	Auto 108°F–126°F (42°C–52°C)							
	Rinse 136°F–144°F (58°C–62°C)							
	Dry							
LIGHT	Pre-Wash	106	129	132	136	144	130	N.A.
	Wash 118°F (48°C)							
	Rinse 136°F (58°C)							
	Dry							
EXPRESS WASH	Pre-Wash 104°F (40°C)	60	60	60	N.A.	75	95	137
	Wash 131°F (55°C)							
	Rinse 131°F (55°C)							
	Rinse 136°F (58°C)							
	Dry							
RINSE	Rinse Only	20	N.A.	N.A.	N.A.	N.A.	N.A.	N.A.

WASH CYCLE SELECTIONS

Cycle times are approximate and will vary with options selected. Hot water is necessary to activate dishwasher detergent and melt fatty food soils. An automatic sensor will check the incoming water temperature, and, if it is not hot enough, the timer will be delayed for automatic water heating in the main wash of all cycles. This happens even when Hi-Temp Wash is selected, as an even higher temperature will be guaranteed to handle heavier soil loads.,

CARE AND CLEANING

CLEANING THE EXTERIOR DOOR AND CONTROL PANEL

1 Clean the stainless steel door and handle regularly with a soft cloth to remove any debris.

Do not use appliance wax, polish, bleach or products containing chlorine to clean the stainless steel door.

2 Gently clean the control panel with a damp cloth.

CLEAN THE STAINLESS STEEL INNER DOOR AND TUB

The tub is made of stainless steel. It will not rust or corrode if the dishwasher is scratched or dented.



Clean any spots on the steel inner door and tub with a damp, nonabrasive cloth.

CLEAN THE CYLINDER FILTER

The Cylinder Filter is designed to collect some big items such as broken glass, bones and pits. The Cylinder Filter needs to be cleaned to maximize wash performance.

To remove the Cylinder Filter, remove the Lower Rack, rotate the Cylinder Filter as shown and lift out the filter. Empty and clean it by holding it under running water and replace it into position.

⚠ WARNING

BURN HAZARD

Allow the heating element to cool before cleaning the interior. Failure to do so can result in burns.

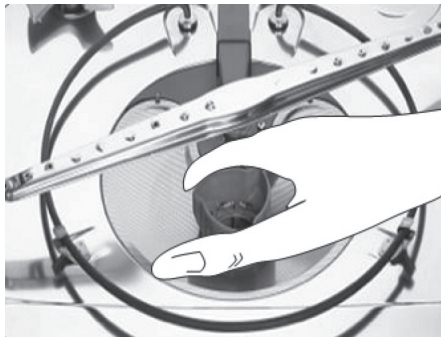

CLEAN THE FINE FILTER

To remove the Fine Filter, remove the Lower Rack, then remove the bottom spray arm as shown below and remove the Cylinder Filter.

Remove the Fine Filter from the dishwasher tub bottom. Flush it clean by holding it under running water and replace it into position.

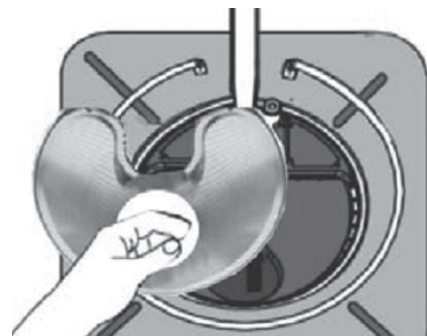
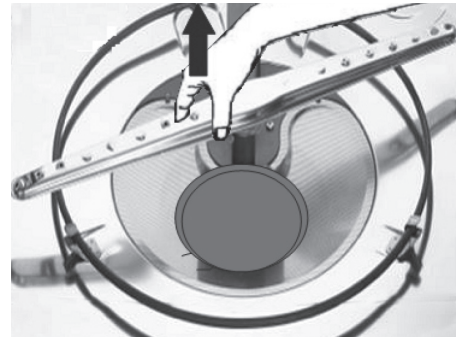
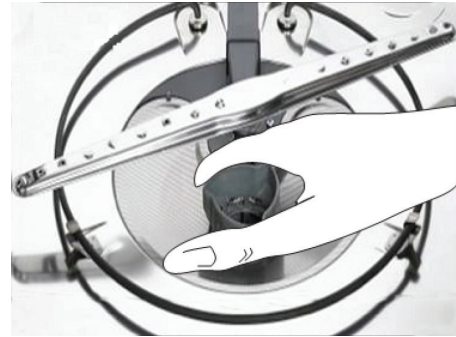

CARE AND CLEANING

CLEAN THE DOOR GASKET

Clean the door gasket with a damp cloth regularly to remove food particles.

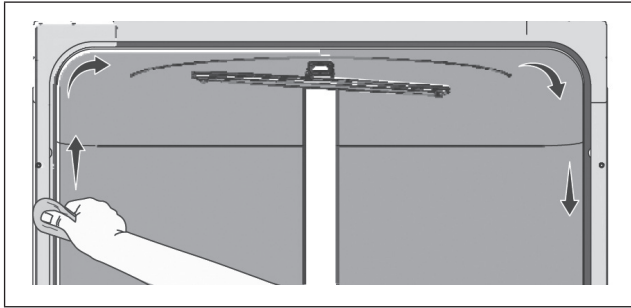

INSIDE

The inside of the dishwasher is self-cleaning with normal use. If needed, clean the tub gasket with a damp cloth and use a brush similar to the one shown below to clean the opening in the end of the gasket.

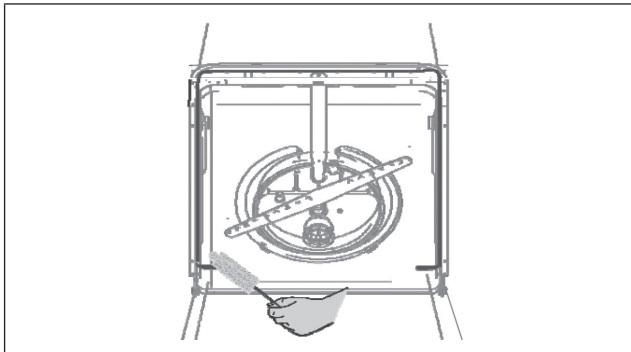

WATER TEMPERATURE

Hot water is required for optimum dishwashing and drying results. Water entering the dishwasher should be at least 120°F (49°C) to achieve satisfactory results.

To check water temperature entering dishwasher:

- 1 Turn on the hot water faucet near the dishwasher and let it run for several minutes.
- 2 Hold a thermometer (such as a candy or meat thermometer) in the water stream to check the temperature. If temperature is below 120°F (49°C), have a qualified person raise the hot water heater thermostat setting.

IMPORTANT

To ensure the water entering the dishwasher is hot, run hot water from the nearest hot water faucet to clear cool water from the pipe before starting the cycle.

WATER PRESSURE

The hot water supply line for the dishwasher must provide water pressure. During high-demand periods, such as when a laundry washing machine or a shower is in use, water pressure may be low. For optimum performance, wait until hot water demand is reduced before operating the dishwasher.

AIR GAP

An air gap is an external plumbing device separate from the dishwasher, usually located on the sink or countertop near the dishwasher. Some state and local plumbing codes require the use of an air gap between a built-in dishwasher and the home drain system.

If an air gap is installed with your dishwasher, ensure it is clean so the dishwasher drains properly. To clean the air gap, turn off the dishwasher, lift the metal cover to remove, unscrew the plastic air gap and clean it with a toothpick.

STORE DISHWASHER WHEN UNUSED

Your dishwasher should be properly protected from freezing when left in an unheated place. Have a qualified technician perform the steps listed below.

To Disconnect Service:

- 1 Turn off electrical power to the dishwasher at the supply source by moving fuses or tripping the circuit breaker.
- 2 Turn off the water supply.
- 3 Place a pan under the inlet valve. Disconnect water line from inlet valve and drain into pan.
- 4 Disconnect drain line from pump and drain water into pan.

To Restore Service:

- 1 Reconnect the water, drain and electrical power supply.
- 2 Turn on water and electrical power supply.
- 3 Fill both detergent cups and run dishwasher through a heated wash cycle.
- 4 Check connections to make sure they do not leak.

TROUBLESHOOTING

BEFORE CALLING FOR SERVICE

PROBLEM	POSSIBLE CAUSE	SOLUTION
Dishwasher won't start	Door is not closed properly	Ensure the door is properly closed
	Power supply or power line is not connected	Ensure power supply is correctly connected
	Delay Start option is selected	Refer to Delay Start section in this manual to reset
	Child Lock is activated (selected models)	Refer to Child Lock section in this manual to deactivate
Dishwasher beeps at the end of the cycle	Indicates the wash cycle is finished	This is normal
Rinse Aid Light is on	Rinse aid level is low	Add rinse aid
Dishwasher operates too long	Dishwasher is connected to cold water	Ensure dishwasher is connected to the hot water supply
	Loaded dishes have a heavy soil level	When heavy soil is detected, the Auto and Normal cycles will automatically increase the cycle time
	Sanitize option is selected	When Sanitize option is selected, the cycle time will increase to meet the sanitize temperature requirement
Dishes are not clean enough	Water pressure is temporarily low	Use dishwasher when the water pressure is normal
	Inlet water is low	Ensure the dishwasher is connected to the hot water supply Avoid using the dishwasher when hot water is being used elsewhere in the house
	Dishes are loaded too close together	Refer to the Loading sections in this manual to reload
	Improper use of detergent	Using fresh detergent, add the correct amount depending on the water hardness and the selected cycle
	Selected cycle is not suitable for food soil condition	Choose another cycle for longer washing time
	Spray arms are blocked by items	Ensure the spray arms can rotate fully
Dishes are not dry enough	Rinse aid dispenser is empty	Fill Rinse Aid Dispenser or increase the amount of rinse aid
	Improper loading of dishes	Refer to the Loading sections in this manual to reload
	Selected cycle does not include drying	Select a cycle with drying
Spots and filming on dishes	Water hardness is too high	For extremely hard water, install a water softener
	Improper loading of dishes	Refer to the Loading sections in this manual to reload
	Rinse aid may be too old	Use fresh rinse aid
	Rinse Aid Dispenser is empty	Fill Rinse Aid Dispenser
Etching	Use of too much detergent	Use less detergent
	Inlet water temperature exceeds 150°F	Lower the inlet water temperature
Detergent left in dispenser cup	Detergent may be too old	Use fresh detergent
	Spray arms are blocked by items	Ensure the spray arms can rotate fully
Detergent dispenser will not close	Improper operation of the detergent cover	Refer to the Dispenser sections in this manual to close
Water remains in the dishwasher	Previous cycle has not finished or has been interrupted	Select the proper cycle as indicated by the manual

TROUBLESHOOTING

PROBLEM	POSSIBLE CAUSE	SOLUTION
Dishwasher does not drain properly	Drain is clogged	If an air gap is installed, check the air gap If a food disposer is connected, empty the food disposer
	Drain hose is kinked	Ensure the drain hose is properly connected to the sink
Suds in the tub	Improper detergent is used	Only use automatic dishwasher detergent
Dishwasher leaks	Dishwasher is not level	Refer to the Installation Manual to level the dishwasher
Black or gray marks on dishes	Aluminum utensils have rubbed against dishes	Choose a cycle with a higher water temperature Ensure the inlet water temperature is no less than 120°F
Stained tub interior	Coffee and tea soil	Use a spot cleaner to remove the soil
	Reddish stain, caused by tomato-based foods	Use Rinse Only cycle right after loading to decrease staining
Noise	Detergent cup opening Drain pump running	This is normal
	A hard object has entered the wash module.	When the object is ground up, the sound should stop If the noise persists after a complete cycle, call for service
Dishwasher won't fill	Water valve is closed	Ensure water valve is open
	Door latch may not be properly seated	Ensure the door is closed
Bad odor in dishwasher tub	Drain Hose connected to sink drain between sink trap and the wall	Be sure the Drain Hose is connected to the sink between the sink and the sink trap

ERROR CODES

When some malfunctions occur, the appliance will display error codes to warn you:

CODES	MEANING	POSSIBLE CAUSES
E0	Communication exception	The display can't receive signal or the main board can't send signal Contact customer service
E1	Longer inlet time	Faucet is not opened Water intake is restricted Water pressure is too low
	Improper or Incomplete Draining	Drain Hose is extended more than 10 ft from the dishwasher Drain Hose is not properly looped underneath sink or not installed with air gap Drain Hose is kinked, compressed or otherwise damaged Wrong Drain Hose used (use only supplied Sharp Dishwasher Drain Hose)
E4	Overflow	Some element of dishwasher leaks
E8	Failure of orientation of distributary valve	Open circuit or break of distributary valve
E9	Holding a button for longer than 30 seconds	Water or some other material on the button

⚠WARNING

- If overflow occurs, turn off the main water supply before calling for service.
- If there is water in the base pan because of an overflow or small leak, the water should be removed before restarting the dishwasher.

DRAIN HOSE INSTALLATION

INCORRECT

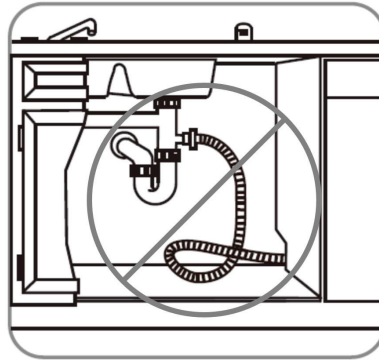

CORRECT - METHOD 1

AIR GAP WITH WASTE TEE OR DISPOSER

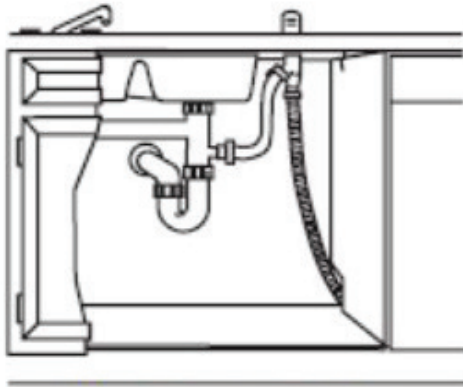

WASTE TEE INSTALLATION

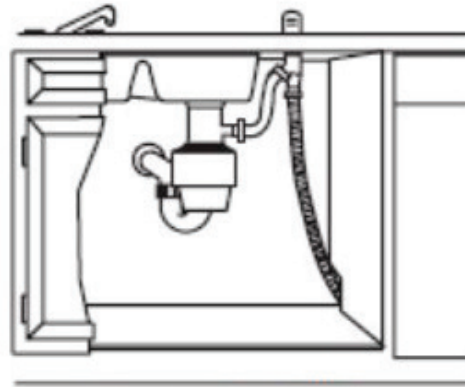

DISPOSER INSTALLATION

CORRECT - METHOD 2

HIGH DRAIN LOOP WITH WASTE TEE OR DISPOSER

**FASTEN TO UNDERSIDE
OF COUNTERTOP**

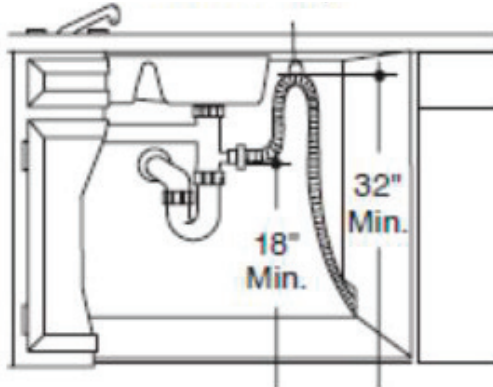

WASTE TEE INSTALLATION

**FASTEN TO UNDERSIDE
OF COUNTERTOP**

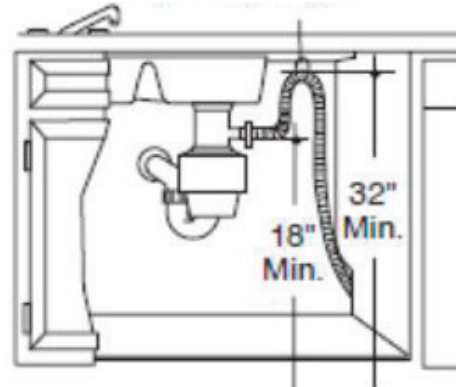

DISPOSER INSTALLATION

SHARP[®]

SHARP ELECTRONICS CORPORATION • 100 Paragon Drive • Montvale, New Jersey 07645 • USA