

FISHER & PAYKEL

**INTEGRATED
REFRIGERATOR FREEZER**

RS3684WRUVE1 and RS3684WLUVE1 models

USER GUIDE

US CA

CONTENTS

Safety and warnings	4
Prior to installation	9
Product overview	11
Control panel	12
Menu	13
Using your refrigerator-freezer	14
Using the refrigerator compartment	15
Adjusting the refrigerator shelves	16
Using the water dispenser	18
Using the Variable Temperature Drawer	19
Using the freezer compartment	20
Using the ice maker	21
Wi-Fi connection	22
Accessing the menu	23
Cleaning	24
Troubleshooting	29
Faults	33
Manufacturer's warranty and service guide	34

Registration

To register your product visit our website: fisherpaykel.com/register

⚠ WARNING!



Electric Shock Hazard

Failure to do so can result in death, electric shock, fire or injury to persons.

- Read and follow the safety and warnings outlined in this guide before operating this appliance.

⚠ WARNING!



Tip Hazard

- This product may tip until it is fully installed. Keep children away and take care. Failure to follow this advice may result in injury.
- This appliance is top-heavy and must be secured to prevent the possibility of tipping forward.

To ensure that the appliance is stable under all loading conditions:

- The anti-tip bracket and fittings supplied must be installed by a professional installer according to the installation steps in this guide.
- This product may tip when the anti-tip bracket is unscrewed. Refer to installation instructions to safely uninstall the product.

⚠ WARNING!



This appliance contains flammable refrigerant isobutane (R600a).

READ AND SAVE THIS GUIDE

SAFETY AND WARNINGS

WARNING!

Read Safety Guide. Failure to follow all guides and rules could cause personal injury or property damage. When using this appliance, always exercise basic safety precautions including the following:

General Use

- This product has been designed for use in a normal domestic (residential) environment.
- Children should be supervised to ensure that they do not play with the appliance.
- Cleaning and user maintenance shall not be undertaken by children without supervision.
- This appliance can be used by children aged from 8 years and above and persons with reduced physical, sensory or mental capabilities or lack of experience and knowledge if they have been given supervision or instruction concerning use of the appliance in a safe way and understand the hazards involved.
- The manufacturer's installation instructions for product and cabinetry ventilation must be followed when installing the appliance.
- To avoid hazard due to instability of the appliance, it must be fixed in accordance with installation instructions.
- Keep ventilation openings, in the appliance enclosure or the built-in structure, clear of obstruction.
- Do not use mechanical devices or other means to accelerate the defrosting process, other than those recommended by the manufacturer.
- Do not damage the refrigerant circuit.
- In case of damage to the refrigerant circuit, ventilate the area by opening all windows.
- Do not operate electrical equipment or any other equipment that may produce arcs, sparks or flames in the area. Contact your Fisher & Paykel trained and supported service technician immediately to arrange for the appliance to be repaired.
- Connect to potable water supply only.
- This refrigerating appliance is intended to be used at ambient temperatures ranging from 61°F (16°C) to 100°F (38°C). The product performance may be compromised when operating outside of this temperature range.
- For storage of general household foods in the most efficient manner, it is recommended to use the product in the factory configuration supplied. Moving the shelves and bins will have a minimal impact on efficiency.
- It is hazardous for anyone other than a Fisher & Paykel trained and supported service technician to service this appliance.
- Ensure the installer has completed the final checklist in the installation guide.

Electrical

- This appliance must be installed in accordance with the installation instructions before use.
- To allow disconnection of the appliance from the supply after installation, incorporate a switch in the fixed wiring in accordance with the wiring rules.
- Never unplug your refrigerator by pulling on the power cord. Always grip the plug firmly and pull straight out from the outlet.
- Do not plug in any other appliance at the same power point as your refrigerator or use extension cords or double adapters.
- Repair or replace immediately all electric service cords that have become frayed or otherwise damaged. Do not use a cord that shows cracks or abrasion along its length or at either the plug or appliance end.
- If the power supply cord is damaged, it must only be replaced by your Fisher & Paykel

SAFETY AND WARNINGS

trained and supported service technician because special purpose tools are required. When moving your appliance away from the wall, be careful not to roll over or damage the power cord.

- Do not use electrical appliances inside the food storage compartments of the appliance, unless they are of the type recommended by the manufacturer.
- When positioning the appliance, ensure the power cord is not trapped or damaged.
- Do not locate multiple portable socket-outlets or portable power supplies at the rear of the appliance.

Food safety

- Regularly clean accessible draining systems and surfaces that come in contact with food.
- Ensure any raw meat or fish is stored in sealed containers to prevent cross-contamination.
- Immediately clean any drips or spills on surfaces.
- If the appliance will be left empty for long periods, switch off, defrost, clean, dry, and leave the door open to prevent mould developing within the appliance.
- Opening the door for long periods can cause a significant increase of the temperature in the compartments of the appliance.

Storing food and drinks/wine

- Do not store explosive substances such as aerosol cans with a flammable propellant in this appliance.
- Never store volatile or flammable materials in your appliance as they may explode.
- Never freeze liquids in glass containers. Liquid expands during freezing, which may cause the container to explode.
- Never freeze carbonated drinks. They may explode.

Servicing

- Your refrigerator is designed to operate for many years without the need for service checks. However, if your refrigerator is malfunctioning, have it attended to by your Fisher & Paykel trained and supported service technician as soon as possible. All electrical repairs must be carried out by an adequately trained service technician or qualified electrician.
- The LED light cannot be serviced by the user. Contact your Fisher & Paykel Dealer or Fisher & Paykel trained and supported service technician.
- If you suspect that the product is not getting cold—items such as ice cream are melting—remove all perishable food and store in another appliance or cooler to prevent spoilage. Immediately call for a service technician.

Cleaning

- Use mild dish-washing liquid with warm water and a lint-free cloth to clean the product.
- Avoid using anti-bacterial cleaning products on either the interior or exterior of the cabinet as they may cause rusting of metal components and cracking of plastic components.

SAFETY AND WARNINGS

Disposal

- Extreme care must be taken when disposing of your old appliance to avoid hazards:
- The flammable refrigerant gas must be safely removed by a qualified service technician.
- The thermal insulation foam in this appliance may contain flammable insulation blowing gases, any exposed foam may be highly flammable and must be carefully treated during disposal.
- **WARNING:** Risk of child entrapment. Before you throw away your old refrigerator or freezer, the doors and panels should be removed and the racks left in place so that children may not easily climb inside.
- Consult your local energy authority or local codes as to the best way to dispose of your old appliance.
- Remove all packaging and dispose of it responsibly. Recycle items that you can.

Water connection

- The water connection to your Ice & water refrigerator must be installed by an authorised plumber or Fisher & Paykel trained and supported service technician.
- Installation and use **MUST** comply with all state and local plumbing codes. Check with your local public works department for plumbing codes. You must follow their guidelines as you install the water filtration system.
- If the water tank has not been used for an extended period of time, or has developed an unpleasant taste or odor, flush the water system. If the problem persists, replace the water filter cartridge and refer to the flushing instructions detailed in section 'Flushing the water filter'.
- To avoid serious illness or death, only connect your water filter to safe drinking water.
- The water filter cartridge needs to be changed when the replacement indicator icon illuminates. This will happen every six months.
- If the water filtration system has been allowed to freeze, replace filter cartridge. Failure to replace the disposable filter at recommended intervals may lead to reduced filter performance and failure of the filter, causing property damage from water leakage or flooding.
- In cases of excessively reduced filter life — we recommend that you consult a local plumber or your water supplier for advice on suitable filtration requirements for the water supplied to your home.
- Filter replacement is the consumer's responsibility and will not be covered by the warranty except in the case of faulty parts or materials within the filter cartridge.
- If the water has not created ice for some time or ice has an unpleasant taste or odor dispose of ice and refer to 'Flushing the water filter' for flushing instructions. If unpleasant taste or odor persists, you may wish to fit a new filter cartridge.
- The new hose-sets supplied with the appliance are to be used and that old hose-sets should not be reused.
- Your water filtration system can withstand up to 120psi (827kPa) of water pressure.
- If a pressure limiting valve is supplied, ensure that it is installed before installing the water filtration system. **DO NOT** install if water pressure exceeds 120psi (827kPa).

To reduce the risk associated with property damage due to water leakage or flooding:

- **DO NOT** install systems in areas where ambient temperatures may go above 100°F (38°C) or drop below 33°F (0.6°C).
- **DO NOT** install on hot water supply lines. The maximum operating water temperature of this filter system is 100°F (38°C).
- **DO NOT** install where water hammer conditions may occur. If water hammer conditions exist, you must install a water hammer arrester.

SAFETY AND WARNINGS

WARNING!

To reduce the risk associated with choking:

- DO NOT allow children under 3 years of age to have access to small parts during the installation of the water filter.

Ice making

- Avoid contact with the moving parts of the ice maker ejector mechanism, and do not place your fingers on the automatic ice-making mechanism while the appliance is in operation.
- At first use or after water filter has been replaced, there may be discolouration in the first bin of ice cubes. Discard the discoloured ice cubes. If discolouration continues in succeeding bins, contact your Fisher & Paykel trained and supported service technician.

Power failure

- In the event of a power interruption, the appliance will automatically save the current temperature settings. When power is recovered, the appliance will revert to the current temperature settings only.
- Most power failures are corrected within a short period of time. 1–2 hours loss of power will not affect the appliance's temperatures.
- To avoid sudden change of temperature while the power is off, you should avoid opening the door. A refrigerator will keep food safe for up to 4 hours during a power outage. Keep the door closed as much as possible. Discard refrigerated perishable food such as meat, poultry, fish, eggs, and leftovers after 4 hours without power.

IMPORTANT!

This device complies with part 15 of the FCC Rules. Operation is subject to the following conditions:

- This device may not cause harmful interference.
- This device must accept any interference received, including interference that may cause undesired operation.
- Do not change or modify the wireless communication device in any way. Changes or modifications not expressly approved by Fisher & Paykel could void the user's authority to operate the equipment.

WARNING: The incorporated Wi-Fi module in this appliance is to operate only from channel 1 to channel 11 as per FCC rules.

This device contains licence-exempt transmitter/receiver that comply with Innovation, Science and Economic Development Canada's licence-exempt RSS(s). Operation is subject to the following two conditions:

- This device may not cause interference.
- This device must accept any interference, including interference that may cause undesired operation of the device.

PRIOR TO INSTALLATION

- The anti-tip bracket and fittings supplied must be fitted to the wall of the finished enclosure to withstand a 221 lbs (100kg) load.
- Your appliance may include front and rear rollers designed for moving the appliance forward and backward. Do not move the appliance sideways as this may damage the rollers or the floor covering / surface.
- The appliance must be installed by a qualified installer, or Fisher & Paykel trained and supported service technician to avoid faulty electrical connection and water leaks.
- All connections for water, electrical power and grounding must comply with local codes and ordinances and be made by licensed personnel when required.
- Avoid installation of the appliance/s under a ground fault circuit interrupter (GFCI).
- Ensure the appliance is installed properly. Improper installation that results in appliance failure is not covered under the appliance warranty.

Check the cabinetry

- Check the dimensions—height, width, depth, floor level, finished alcove returns.
- Ensure that the ventilation openings in the cabinetry are clear of obstruction.
- For integrated installation, a finished return of solid material is required across the top and sides of the new or existing alcove.
- Refer to the 'Product and Cavity Dimensions' prior to installation of the appliance.

Check the power supply

- Ensure that there is a separate power outlet for the appliance.
- Avoid sharing the power point with other appliances to prevent the appliance from accidentally switching off.
- For power requirements, refer to the information on the serial plate. This is located at the front right-hand side of the drawer when open.
- Do not remove the ground prong from the fitted power cord plug.
- Connect the appliance to a grounded electrical supply (115 V, 60 Hz) with fitted power cord.
- We recommend to use an isolating switch that is easily accessible to the user after the appliance is installed.
- Follow the National Electrical Code, Canadian Electrical Code and all other local codes and ordinances when installing this appliance.

Check the water supply (for Ice and Water models only)

- Ensure that there is a separate water supply connection for the appliance.
- Your appliance must be installed by a qualified appliance installer as incorrect plumbing can lead to water leaks.
- **Fisher & Paykel is not liable for damage (including water damage) caused by faulty installation or plumbing.**

PRIOR TO INSTALLATION

Insert hinge limiting pin

- Before opening the doors, ensure that the appliance is stable.
- Follow these steps to avoid risks that can cause serious injury or death.

For 90° door swing, a hinge limiting pin is supplied with your appliance. This pin fits in the boreholes of the top hinge

- ① Open door to 90°.
- ② Insert the hinge limiting pin vertically into the bore hole. Tap the pin gently if it does not slide smoothly.

All product information, including installation guides, can be sourced and downloaded from www.fisherpaykel.com

PRODUCT OVERVIEW



Features

- ① Control panel
- ② Adjustable glass shelves
- ③ Adjustable door shelves
- ④ Bottle holders
- ⑤ Water dispenser (not shown)
- ⑥ Humidity control bin
- ⑦ Variable temperature drawer
- ⑧ Upper freezer bin
- ⑨ Automatic ice maker
- ⑩ Freezer tray
- ⑪ Lower freezer bin
- ⑫ Freezer tray removal tool (not shown)

CONTROL PANEL

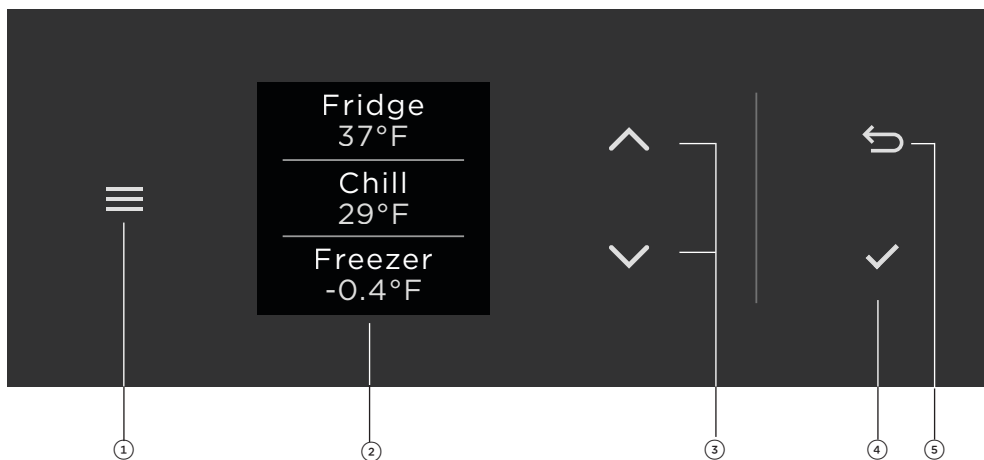

① Menu	Press to access product features and settings, or to return to standby. If the display has been locked, hold for two seconds to unlock.
② Display screen	Displays product features and settings.
③ Scroll	Press to select modes and adjust temperatures. Enables you to scroll through the menu, features and settings.
④ Select	Press to confirm and activate the selected features and settings.
⑤ Back	Press to go back to the previous menu.

MENU



TEMPERATURE SET	Select a mode or adjust the temperature. Refer to 'Modes'.
ICE	Turn the ice maker on or off.
ICE BOOST	Boost ice production for the next 24 hours.
MAX COLD	Quickly cool down items that have just been added to the product. The product will temporarily drop to its coldest temperature.
BOTTLE CHILL	Set a 15-minute timer when chilling wine or other beverages in the freezer.
WATER DISPENSER	Lock the water dispenser to prevent accidental use.
DOOR ALARM	Mute the door alarm for 20 minutes or until the door is closed again.
DISPLAY LOCK	Lock the controls to prevent accidental use.
SABBATH MODE	For the Sabbath observant. In Sabbath Mode alarms, lights and the display will be deactivated for 80 hours. <ul style="list-style-type: none">• The lights will not turn on when you open the door.• The door alarm will not operate.• The display will not illuminate.• The display will be unresponsive.
SETTINGS	Adjust the appliance settings to suit your preferences or set up a Wi-Fi connection. Refer to 'Wi-Fi connection'.

USING YOUR REFRIGERATOR-FREEZER

- Adjust the temperatures for each compartment as required.
- Select a mode for the upper and lower compartments to suit the food you will be storing.
- Arrange your shelves as desired.
- Adjust the settings to suit your preferences.

COMPARTMENT	MODE	
Upper compartment	FRIDGE (34 to 43°F)	For fresh, everyday foods such as fruit and vegetables, dairy products, meats, seafood, ready-to-eat foods, leftovers, sauces, preserves and drinks.
	Variable temperature drawer	See above.
Lower compartment	PANTRY (52 to 55°F)	For foods that perish quickly at room temperature but are too sensitive to be stored at normal refrigerator temperatures.
	CHILL (29 to 32°F)	Store highly perishable meats and seafood up to three times longer. Also for chilling alcoholic beverages such as beer, champagne and wine.
	SOFT FREEZE (14 to 18°F)	An extension of your refrigerator. Extends shelf life of fresh items for weeks.
	FREEZER (-6 to 7°F)	For general frozen items that require storage between 1 - 12 months.

USING THE REFRIGERATOR COMPARTMENT

For optimal food care, the upper compartment has one available mode to keep everyday food fresh.

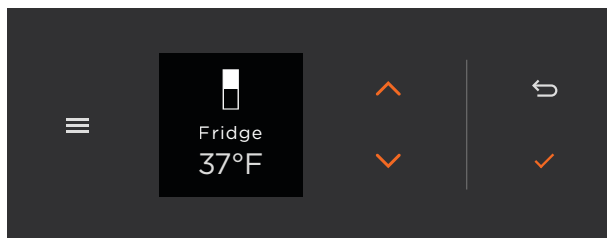

1. Press ∇ or \blacktriangle to select the upper compartment, then press \checkmark to confirm.

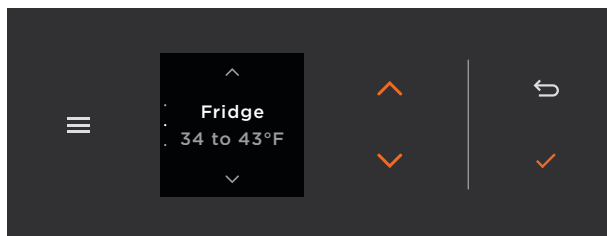

2. Press ∇ or \blacktriangle to select a mode, then press \checkmark to confirm.

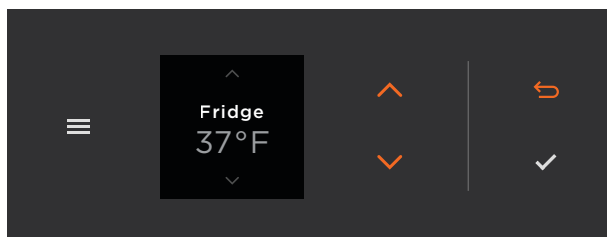

3. Press ∇ or \blacktriangle to adjust the temperature, and press \checkmark to confirm.
Press \leftarrow at any point to exit the menu.

ADJUSTING THE REFRIGERATOR SHELVES

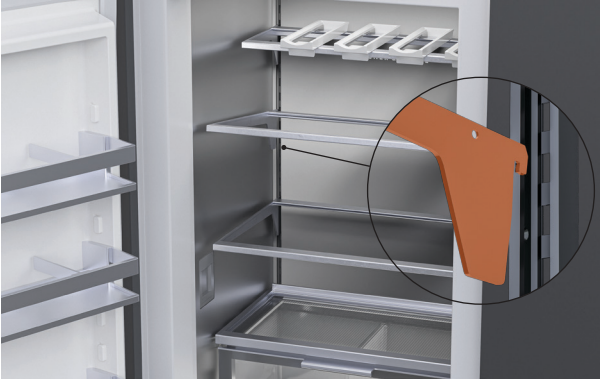

Glass shelves

Adjust height or remove as needed. The shelves hook onto supports at the rear.

To remove, tilt shelf up to dislodge it from support, then pull it out.

To refit, hook the shelf back onto supports at desired height.



Door shelves

Adjust height or remove.

Shelves slot onto the hooks on the sides of the door.



Bottle holders

Slide to reposition, and unhook to remove.

ADJUSTING THE REFRIGERATOR SHELVES



Humidity control bin

Reposition or remove dividers as needed. Refer to 'Cleaning' for removal instructions.

USING THE WATER DISPENSER

The water dispenser is located inside on the left side wall of the top compartment. When dispensing water for long durations, a time-out period may occur. An alarm will sound. Please wait 4 minutes before dispensing again.

Replace the water filter when alerted. To fit replacement filter, follow the instructions supplied with the new filter.



Dispensing water

Gently press the dispensing pad with a glass or container.

Pressing harder will not increase the flow of water.



To stop, simply pull your glass or container away from the dispensing pad.

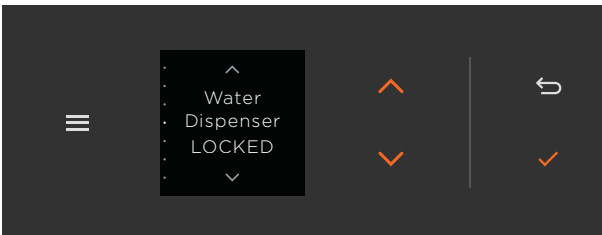

Locking and unlocking the water dispenser

1. Press  to access the menu.







2. Press  or  to scroll to **WATER DISPENSER**, then press  to lock or unlock the dispenser.

USING THE VARIABLE TEMPERATURE DRAWER

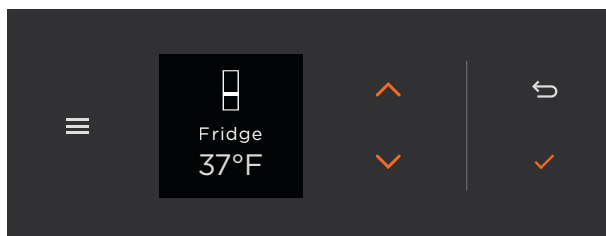

For optimal food care, the Variable Temperature Drawer lets you change between three modes - Chill, Fridge and Pantry. You can select a range of temperatures within each mode.

FRIDGE (34 to 43°F)	For fresh, everyday foods such as fruit and vegetables, dairy products, meats, seafood, ready-to-eat foods, leftovers, sauces, preserves and drinks.
PANTRY (52 to 55°F)	For foods that perish quickly at room temperature but are too sensitive to be stored at normal refrigerator temperatures.
CHILL (29 to 32°F)	Store highly perishable meats and seafood up to three times longer. Also for chilling alcoholic beverages such as beer, champagne and wine.



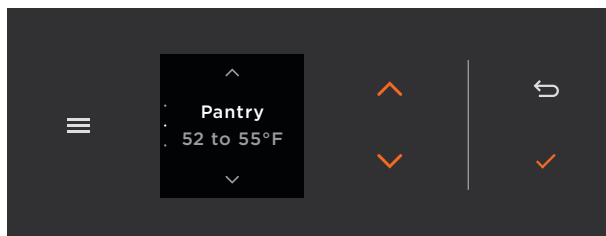



1. Press  or  to select the Variable Temperature Drawer, then press  to confirm.

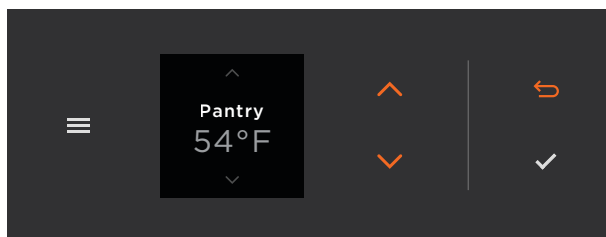

2. Press  or  to select a mode, then press  to confirm.



3. Press  or  to adjust the temperature, and press  to confirm.
Press  at any point to exit the menu.

USING THE FREEZER COMPARTMENT

For optimal food care, the Freezer lets you change between two modes - Soft Freeze and Freezer. You can select a range of temperatures within each mode.

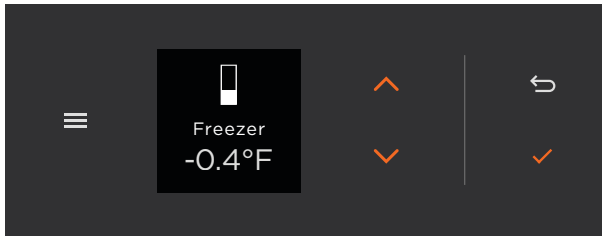

1. Press ∇ or \wedge to select the lower compartment, then press \checkmark to confirm.

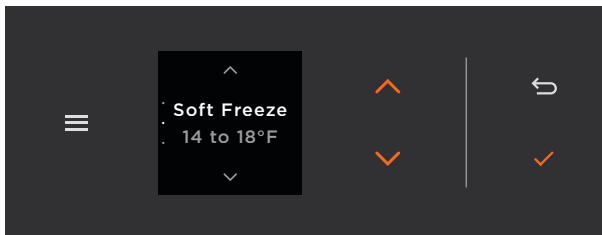

2. Press ∇ or \wedge to select a mode, then press \checkmark to confirm.

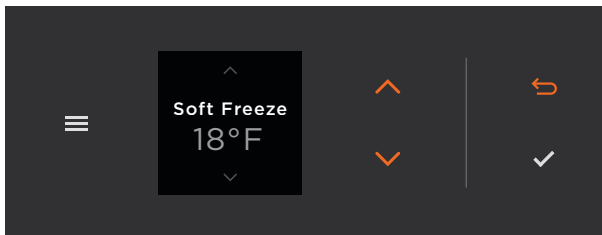

3. Press ∇ or \wedge to adjust the temperature, and press \checkmark to confirm.
Press \leftarrow at any point to exit the menu.

USING THE ICE MAKER

The ice maker produces ice directly into the storage bin and automatically makes more to replace what you use. Keep the ice cubes level in the bin to maximise storage space.

The ice maker may take several hours to begin producing ice.

Turn your ice maker off if:



- There is no water supply for several hours.
- You are removing the ice storage bin for a long period of time.
- You are going on holiday.

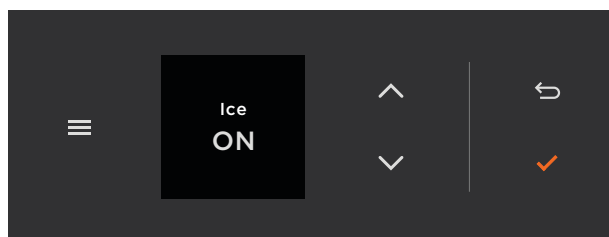

Turning ice maker on or off

1. Press  to access the menu.



2. Press  or  to scroll to ICE, then press  to turn the ice maker on or off.



Making extra ice

Remove the storage bin and allow ice to fall into the larger bin.

You can turn on **ICE BOOST** to make extra ice for up to 24 hours. Turn **ICE BOOST** on or off via the menu.

WI-FI CONNECTION

Your appliance may be connected to your home wireless network and operated remotely using the app.

Getting started



- Ensure your home Wi-Fi network and Bluetooth on your mobile device are turned on.
- You will be given step-by-step guidance on mobile device.
- It may take up to 10 minutes to connect your appliance.

On your mobile device:

- ① Download the app from www.fisherpaykel.com/connect
- ② Register and create an account.
- ③ Add your appliance and set up the Wi-Fi connection.

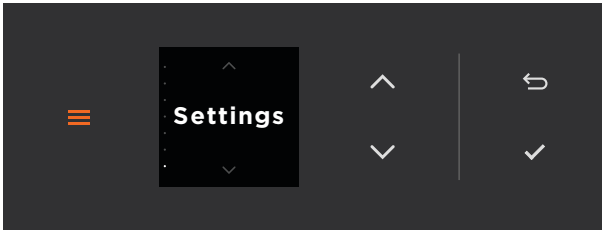
Connecting to Wi-Fi



1. Press  to access the menu, then  or  to scroll to **SETTINGS**.

Press  to select.

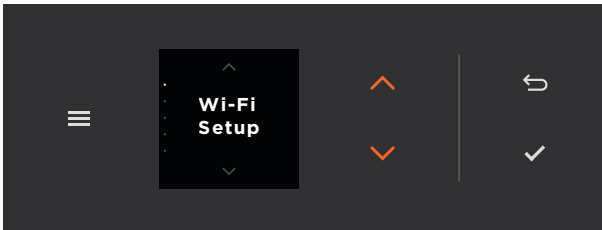

2. Press  or  to scroll to **WI-FI SETUP**.

Press  to select.

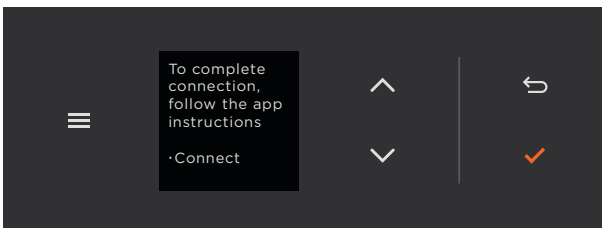

3. Follow the prompts on the display and in the app to complete setup.

ACCESSING THE MENU

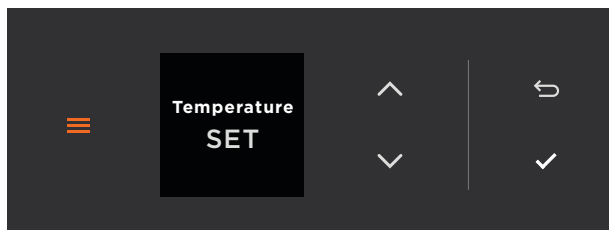

1. Press ☰ to access the menu.

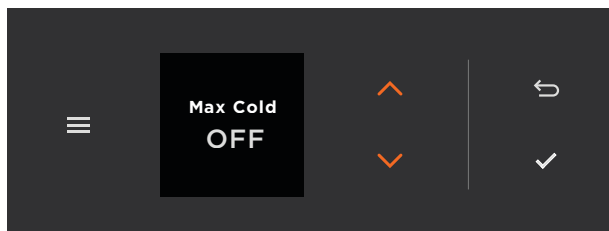

2. Press ▼ or ▲ to scroll to the desired feature and press ✓ to select.

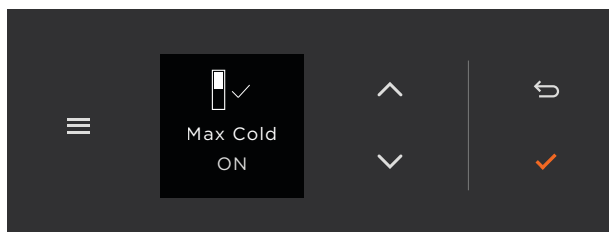

3. Adjust as needed and press ✓ to confirm.



4. Press ↶ at any point to exit the menu.

CLEANING

Surfaces, shelves and racks

Remove racks, then wipe interior surfaces with a damp cloth and mild detergent. Dry with a clean, lint-free cloth. Use a small brush to clean difficult to reach spots if needed.

We do not recommend using the following cleaning products as they may cause damage:

- Plastic or stainless steel scouring pads
- Abrasive, solvent, household cleaners
- Acid or alkaline cleaners
- Hand washing liquids or soap
- Stainless steel cleaners or polishes
- Laundry detergents or disinfectants

Door seal

Use a small brush to clean around the door seal as needed.

Toe kick grilles

We recommend cleaning the grille every 6 months, and regularly vacuuming the floor in front of your appliance to keep ventilation openings clear.

Bins

Bins can be removed for cleaning. Wipe clean with a damp cloth and mild detergent, then dry with a clean, lint-free cloth.

Water filter

Replace the water filter when alerted. To fit replacement filter, follow instructions supplied with new filter. Once new filter is fitted, go to **SETTINGS** to reset the water filter timer.

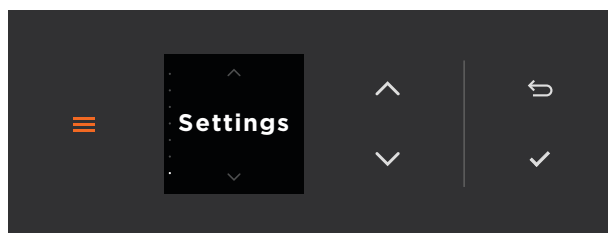

1. Press **☰** to access the menu, then **↓** or **↑** to scroll to **SETTINGS**. Press **✓** to select.

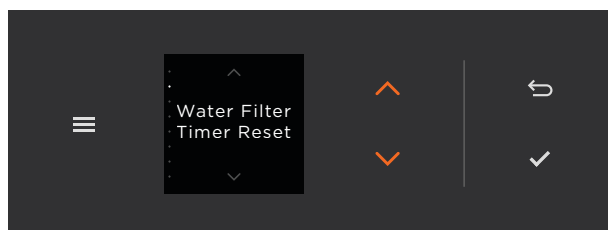

2. Press **↓** or **↑** to scroll to **WATER FILTER TIMER RESET**. Press **✓** to select and again to confirm.

CLEANING

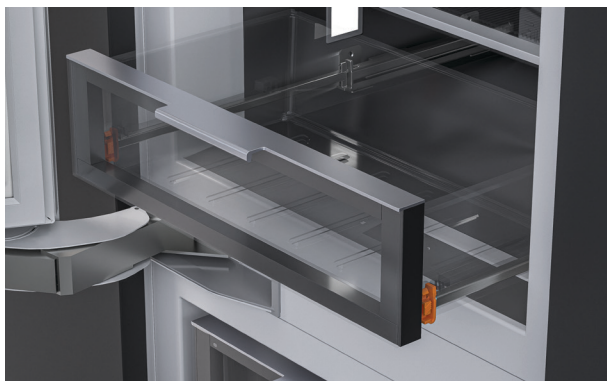

Removing the fridge bins

1. Pull the bin towards you, and push in tabs on either side to release bin from runners.

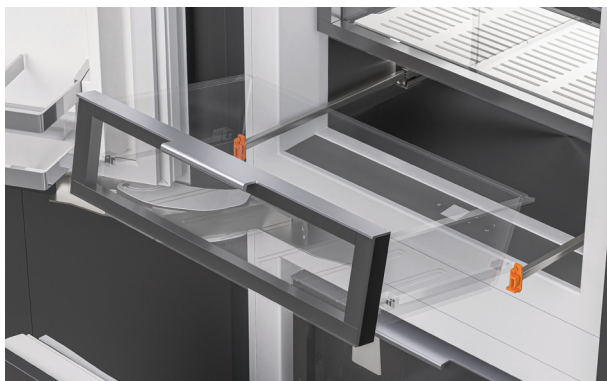

2. To refit, extend the runners and place the bin on top. Slowly push bin onto tabs until you feel them clip into place.

CLEANING



Removing upper freezer bin

1. Pull the bin towards you, and push in tabs on either side to release bin from runners.

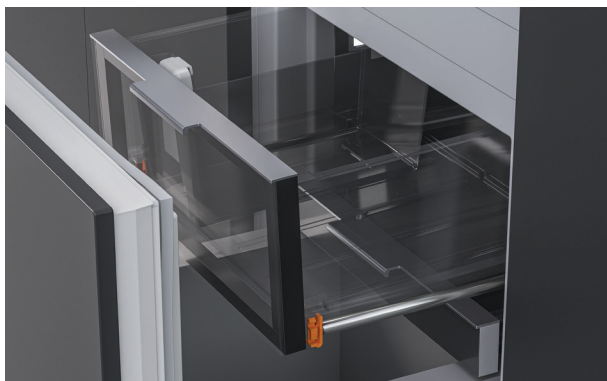

2. To refit, extend the runners and place the bin on top. Slowly push bin onto tabs until you feel them clip into place.

CLEANING

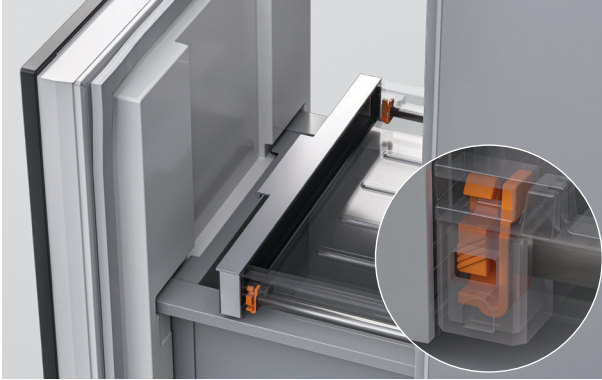

Removing lower freezer bin

1. Open the bin fully and use a flathead screwdriver to unclip the tray from the sliders. Remove the tray and push sliders back in.

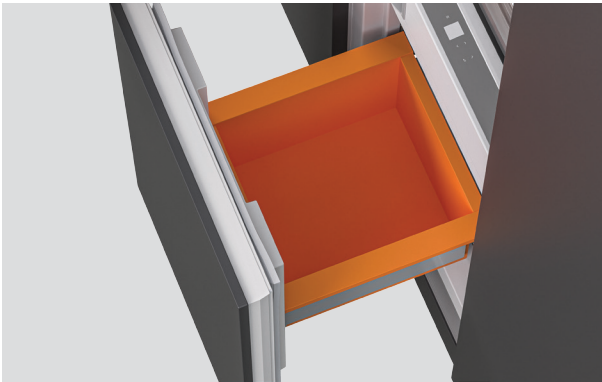

2. Lift the bin slightly and slide it back inside the freezer to separate it from the supports. We recommend wearing gloves as the bin will be cold.

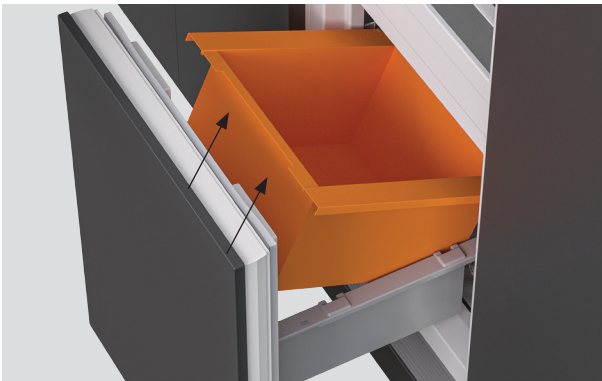

3. Tilt the bin towards the freezer, then lift to remove.

CLEANING

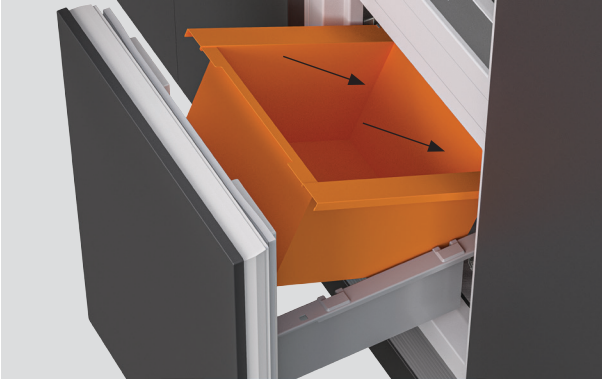

4. To refit, tilt the bin to place it back into the freezer, then lower the front until it sits on the supports. Pull it towards you slightly until it fits into place.

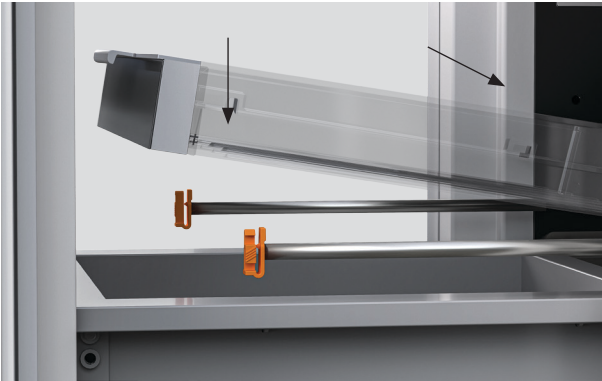

5. To refit the tray, extend the sliders and place the rear of the tray onto them. Clip the tray to the sliders to secure.

TROUBLESHOOTING

General use

Why will the product not turn on?

- No power. Make sure the product is connected to the power supply and switched on at the wall.
 - Check the circuit breaker, or check if there is a power cut in your home or area. If the product still won't turn on, call Customer Care or your Authorized Service Centre.
-

Why is the display not working?

- The product may be in Sabbath Mode. Press and hold  to exit this mode.
-

Why is the light not working?

- Product is not switched on. Check it is turned on at the wall or the isolating switch.
 - Light needs to be replaced. Call Customer Care or your Authorized Service Centre.
-

Why is the product beeping and displaying a code when I open the door?

- There is a fault. Record the code on the display, and call Customer Care or your Authorized Service Centre.
-

Why are the storage compartments too warm?

- Temperature setting not correct. See 'Selecting and adjusting modes and temperatures.'
 - Frequent door openings. Minimise door openings to allow temperature to stabilise.
 - Large number of beverages have been recently added. Take care not to overfill.
-

Why is the product making unfamiliar noises?

- Product is not stable or level. Check Installation guide at www.fisherpaykel.com or call Customer Care or your Authorized Service Centre.
 - Freezer is defrosting. This is normal.
-

Why is the product warm on the outside?

- This is normal.
-

TROUBLESHOOTING

Why is food freezing in the refrigerator?

- Temperature setting needs to be increased. 'Using the refrigerator compartment'.
-

Why can I not select Food Mode?

- Not all food modes are available in all compartments. Refer to 'Food mode presets' for available food mode combinations.
-

Why is there water in the vegetable bins?

- Fruit and vegetables can generate moisture and create condensation. Some condensation is beneficial when storing fruit and vegetables. Wipe out excess water with a cloth.
-

Why does the bin not slide in and out smoothly/fully?

- Packaging is trapped. Check to ensure nothing is trapped behind the tray/bin.
 - Runners not regularly extended. Pull them out to restore full extension. Do not remove the grease from the runners.
-

Why is there condensation/ice in the compartment?

- This is normal during periods of high humidity. Wipe dry with a lint-free cloth.
 - Frequent or too long door openings. Minimise door openings.
 - Door gasket is leaking. Check and clean the door gasket seal.
 - Door not closing tightly. Rearrange items so door can close.
 - Doors not aligned. Call Customer Care or your Authorized Service Centre.
-

Why is there condensation on the outside of the product?

- This is normal during periods of high humidity. Wipe dry with a lint-free cloth.
-

Why is the door not closing?

- Items in the product are preventing door from closing tightly. Rearrange items so door can close.
 - Product is not installed correctly. Check Installation guide at www.fisherpaykel.com or call Customer Care or your Authorized Service Centre.
-

TROUBLESHOOTING

Why are the ice cubes so large/small?

- Blocked water filter. Change filter before calling technicians.
 - Water line is kinked or squashed. Unkink the external water line. If not kinked or squashed, call Customer Care or your Authorized Service Centre.
-

Why is the freezer door not opening?

- The door has recently been opened. Wait 30 seconds and try again.
-

Why are frozen food items soft or melting?

- Temperature setting needs to be adjusted. Refer to 'Food modes'.
 - Remove items and place in another freezer or cooler, and call Customer Care or your Authorized Service Centre.
-

Why is the ice maker not working?

- Ice maker not turned on. Switch ice maker on. Refer to 'Changing features.'
 - Water supply turned off or not connected. Connect the water supply.
 - Water pressure too low. Check water pressure.
 - Water line kinked or squashed. Check water line.
 - Filter is clogged. Replace water filter.
 - Ice cubes are clumped in the bin. Remove ice storage bin, loosen cubes and remove clumped ice. Refit ice storage bin.
 - Freezer compartment not working. Call Customer Care or your Authorized Service Centre.
-

Why do the ice cubes taste tainted?

- Unsealed foods may be emitting an odor. Wrap or cover strong smelling foods, discard ice cubes and clean ice storage bin. Refer to 'Interior cleaning'.
 - Poor taste from incoming water. Replace filter cartridge. Parts and accessories can be purchased through our Customer Care Centre.
-

Why are the ice cubes freezing slowly?

- The door may have been left open. Close the door.
 - Freezer compartment is set too warm. Turn temperature to a colder setting. Refer to 'Adjusting the temperature'.
-

TROUBLESHOOTING

Why is the ice wet/clumping?

- Ice will stick together over time. Tap to unstick.
 - Freezer door open for long periods.
 - High ambient temperature.
 - Ice bin has been left out of the freezer. Gently tap ice to unstick it or empty ice bin and make new ice.
 - The filter is blocked. Replace the filter cartridge.
-

Why is the ice discolored?

- The water filter has not been flushed. Refer to installation guide for details on how to flush your water filter.
-

FAULTS

If a fault occurs, there will be 4 rapid beeps and the fault will be displayed on the control panel.

Record the fault code and contact a Fisher & Paykel trained and supported service technician in order to repair the fault. You can do this by going online to fisherpaykel.com or by contacting our Customer Care Centre.

Normal appliance sounds

This product has been designed to have excellent energy ratings and cooling performance. As a result, it can produce sounds somewhat different to your old appliance.

Low frequency ticking	This is the valve that controls cooling to each compartment. This noise will only last for a few seconds at a time.
Fan air flow	This product has fans which change speed depending on demand. During cooling periods, such as after frequent door openings, fans circulate the cold air in the appliance producing some air-flow sound. This is quite normal.
Cracking or popping	This may occur when the automatic defrost function is operating.
Running water	This is the liquid refrigerant in the system and can be heard as a boiling or gurgling noise.
Hissing sound after closing the door	This is due to the pressure difference between the warm air that has entered the product, and suddenly cooled, and the outside air pressure.
Humming	This is the compressor running and is quite normal.
Ice maker noises	Motor operation (low humming). Running water as the ice maker and/or water tank fills. Water valve opening and closing (hissing sound). Loosened from the ice molding tray (cracking). Ice dropping into bin (clunking).
Other sounds	Product is not stable or level. Bottles or jars rattling on shelves.

MANUFACTURER'S WARRANTY AND SERVICE GUIDE

US



To access your Warranty and Service Guide

Scan the QR code with your smartphone to access your warranty and book a service, refer to your separate warranty and service book or view online at <https://www.fisherpaykel.com/us/help-and-support/warranty-information>

CA



To access your Warranty and Service Guide

Scan the QR code with your smartphone to access your warranty and book a service, refer to your separate warranty and service book or view online at <https://www.fisherpaykel.com/ca/help-and-support/warranty-information>

This product has been designed for use in a domestic (residential) environment. This product is not designed for any commercial use. Any commercial use by the customer will affect this product's Manufacturer's Warranty.

Complete and keep for safe reference:

Model _____

Serial No. _____

Purchase Date _____

Purchaser _____

Dealer _____

City _____

State _____

Zip _____

Country _____

FISHERPAYKEL.COM

© Fisher & Paykel Appliances 2024. All rights reserved.

The models shown in this guide may not be available in all markets
and are subject to change at any time.

The product specifications in this guide apply to the specific products and
models described at the date of issue. Under our policy of continuous product
improvement, these specifications may change at any time.

For current details about model and specification availability in your country,
please go to our website or contact your local Fisher & Paykel dealer.

432117A 10.24