

# DLP® Projector

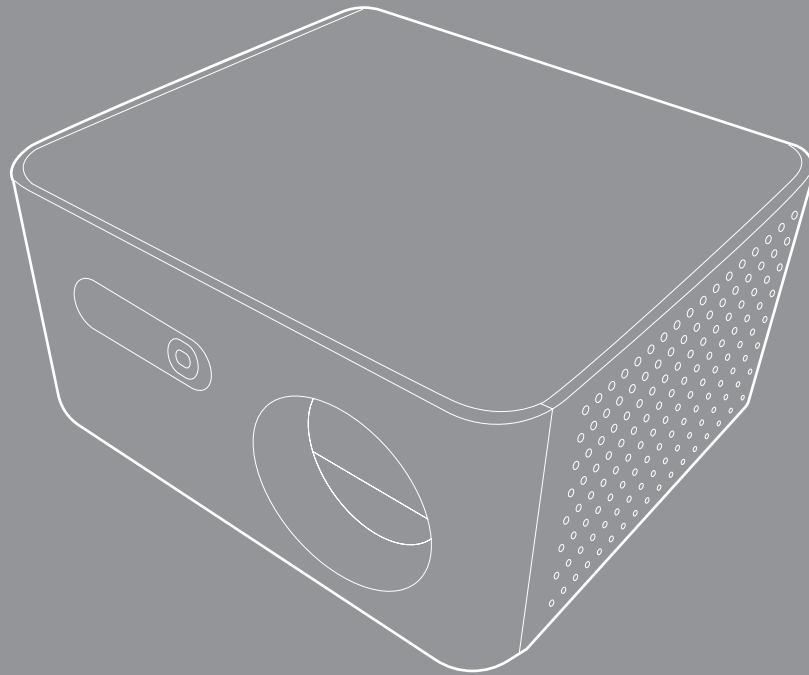

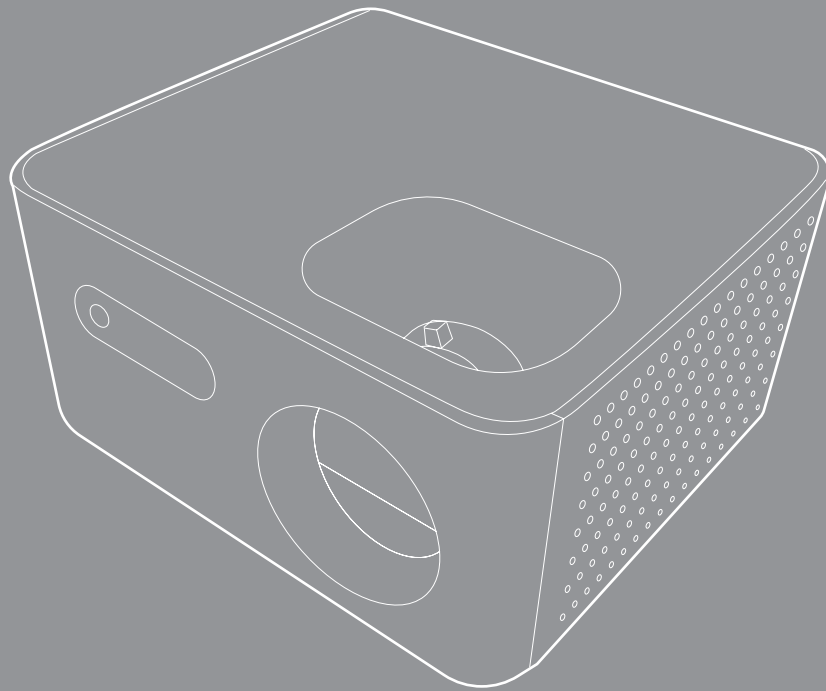

# TABLE OF CONTENTS

<b>SAFETY</b> .....	<b>4</b>
<i>Important safety instructions</i> .....	4
<i>Copyright</i> .....	6
<i>Disclaimer</i> .....	6
<i>Trademark recognition</i> .....	6
<i>FCC</i> .....	6
<i>Declaration of Conformity for EU countries</i> .....	7
<i>WEEE</i> .....	7
<i>Cleaning the lens</i> .....	7
<b>INTRODUCTION</b> .....	<b>8</b>
<i>Package overview</i> .....	8
<i>Standard accessories</i> .....	8
<i>Product overview</i> .....	9
<i>Connections</i> .....	10
<i>Remote control</i> .....	11
<b>SETUP AND INSTALLATION</b> .....	<b>13</b>
<i>Installing the projector</i> .....	13
<i>Connecting sources to the projector</i> .....	15
<i>Adjusting the projector image</i> .....	16
<i>Remote setup</i> .....	18
<b>USING THE PROJECTOR</b> .....	<b>20</b>
<i>Powering on/off the projector</i> .....	20
<i>Selecting an input source</i> .....	21
<i>Menu navigation and features</i> .....	22
<i>OSD menu</i> .....	23
<i>1. Main menu: Image</i> .....	23
<i>2. Main menu: Display</i> .....	27
<i>3. Main menu: Device Setup</i> .....	32
<i>4. Main menu: Input Settings</i> .....	36
<i>5. Main menu: Audio</i> .....	38
<i>6. Main menu: Control</i> .....	40
<i>7. Main menu: Information</i> .....	41
<b>ADDITIONAL INFORMATION</b> .....	<b>42</b>
<i>Compatible resolutions</i> .....	42
<i>Image size and projection distance</i> .....	44
<i>Projector dimensions and ceiling mount installation</i> .....	46
<i>IR remote control codes</i> .....	47
<i>Troubleshooting</i> .....	49

# TABLE OF CONTENTS

<i>Warning indicator</i> .....	51
<i>Specifications</i> .....	52
<i>Optoma global offices</i> .....	54

# SAFETY

	The lightning flash with arrow head within an equilateral triangle is intended to alert the user to the presence of uninsulated "dangerous voltage" within the product's enclosure that may be of sufficient magnitude to constitute a risk of electric shock to persons.
	The exclamation point within an equilateral triangle is intended to alert the user to the presence of important operating and maintenance (servicing) instructions in the literature accompanying the appliance.

Please follow all warnings, precautions and maintenance as recommended in this user's guide.

## Important safety instructions

- Do not block any ventilation openings. To ensure reliable operation of the projector and to protect from over heating, it is recommended to install the projector in a location that does not block ventilation. As an example, do not place the projector on a crowded coffee table, sofa, bed, etc. Do not put the projector in an enclosure such as a book case or a cabinet that restricts air flow.
- To reduce the risk of fire and/or electric shock, do not expose the projector to rain or moisture. Do not install near heat sources such as radiators, heaters, stoves or any other apparatus such as amplifiers that emits heat.
- Do not let objects or liquids enter the projector. They may touch dangerous voltage points and short out parts that could result in fire or electric shock.
- Do not use under the following conditions:
  - In extremely hot, cold or humid environments.
    - (i) Ensure that the ambient room temperature is within 0°C ~ 40°C
    - (ii) Relative humidity is up to 80%
  - In areas susceptible to excessive dust and dirt.
  - Near any appliance generating a strong magnetic field.
  - In direct sunlight.
- Do not use the unit if it has been physically damaged or abused. Physical damage/abuse would be (but not limited to):
  - Unit has been dropped.
  - Power supply cord or plug has been damaged.
  - Liquid has been spilled on to the projector.
  - Projector has been exposed to rain or moisture.
  - Something has fallen in the projector or something is loose inside.
- Do not place the projector on an unstable surface. The projector may fall over resulting in injury or the projector may become damaged.
- Do not block the light coming out of the projector lens when in operation. The light will heat the object and may melt, cause burns or start a fire.
- Please do not open or disassemble the projector as this may cause electric shock.
- Do not attempt to service the unit yourself. Opening or removing covers may expose you to dangerous voltages or other hazards. Please call Optoma before you send the unit for repair.
- See projector enclosure for safety related markings.
- The unit should only be repaired by authorized service personnel.
- Only use attachments/accessories specified by the manufacturer.
- This projector will detect the life of the light source itself.
- When switching the projector off, please ensure the cooling cycle has been completed before

# SAFETY

disconnecting power.

- Turn off and unplug the power plug from the AC outlet before cleaning the product.
- Use a soft dry cloth with mild detergent to clean the projector housing. Do not use abrasive cleaners, waxes or solvents to clean the unit.
- Disconnect the power plug from AC outlet if the product is not being used for a long period of time.
- Do not setup the projector in places where it might be subjected to vibration or shock.
- Do not touch the lens with bare hands.
- Remove battery/batteries from remote control before storage. If the battery/batteries are left in the remote for long periods, they may leak.
- Do not use or store the projector in places where smoke from oil or cigarettes may be present, as it can adversely affect the quality of the projector performance.
- Please follow the correct projector orientation installation as non standard installation may affect the projector performance.
- Use a power strip and or surge protector. As power outages and brown-outs can KILL devices.
- Do not look into the projector lens during operation. The bright light may harm your eyes.
- According to the classification of photobiological safety of light sources and light source systems, this product is Risk Group 2, IEC 62471-5:2015.

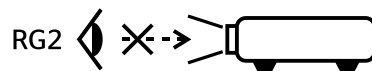

# SAFETY

## Copyright

This publication, including all photographs, illustrations and software, is protected under international copyright laws, with all rights reserved. Neither this manual, nor any of the material contained herein, may be reproduced without written consent of the author.

© Copyright 2025

## Disclaimer

The information in this document is subject to change without notice. The manufacturer makes no representations or warranties with respect to the contents hereof and specifically disclaims any implied warranties of merchantability or fitness for any particular purpose. The manufacturer reserves the right to revise this publication and to make changes from time to time in the content hereof without obligation of the manufacturer to notify any person of such revision or changes.

## Trademark recognition

Kensington is a U.S. registered trademark of ACCO Brand Corporation with issued registrations and pending applications in other countries throughout the world.

The terms HDMI, HDMI High-Definition Multimedia Interface, HDMI Trade dress and the HDMI Logos are trademarks or registered trademarks of HDMI Licensing Administrator, Inc.

DLP®, DLP Link and the DLP logo are registered trademarks of Texas Instruments and BrilliantColor™ is a trademark of Texas Instruments.

All other product names used in this manual are the properties of their respective owners and are Acknowledged.

## FCC

This device has been tested and found to comply with the limits for a Class B digital device pursuant to Part 15 of the FCC rules. These limits are designed to provide reasonable protection against harmful interference in a residential installation. This device generates, uses and can radiate radio frequency energy and, if not installed and used in accordance with the instructions, may cause harmful interference to radio communications.

However, there is no guarantee that interference will not occur in a particular installation. If this device does cause harmful interference to radio or television reception, which can be determined by turning the device off and on is encouraged to try to correct the interference by one or more of the following measures:

- Reorient or relocate the receiving antenna.
- Increase the separation between the device and receiver.
- Connect the device into an outlet on a circuit different from that to which the receiver is connected.
- Consult the dealer or an experienced radio/television technician for help.

### Notice: Shielded cables

All connections to other computing devices must be made using shielded cables to maintain compliance with FCC regulations.

### Caution

Changes or modifications not expressly approved by the manufacturer could void the user's authority, which is granted by the Federal Communications Commission, to operate this projector.

### Operation Conditions

This device complies with Part 15 of the FCC Rules. Operation is subject to the following two conditions:

1. This device may not cause harmful interference and

# SAFETY

2. This device must accept any interference received, including interference that may cause undesired operation.

## Notice: Canadian users

This Class B digital apparatus complies with Canadian ICES-003.

Remarque à l'intention des utilisateurs canadiens

Cet appareil numérique de la classe B est conforme à la norme NMB-003 du Canada.

## Declaration of Conformity for EU countries

- EMC Directive 2014/30/EU (including amendments)
- Low Voltage Directive 2014/35/EU
- RED 2014/53/EU (if product has RF function)

## WEEE



### Disposal instructions

Do not throw this electronic device into the trash when discarding. To minimize pollution and ensure utmost protection of the global environment, please recycle it.

## Cleaning the lens

- Before cleaning the lens, be sure to turn off the projector and unplug the power cord to allow it to completely cool down.
- Use a compressed air tank to remove the dust.
- Use a special cloth for cleaning lens and gently wipe the lens. Do not touch the lens with your fingers.
- Do not use alkaline/acid detergents or volatile solvents such as alcohol for cleaning lens. If the lens is damaged due to the cleaning process, it is not covered by the warranty.



Warning: Do not use a spray containing flammable gases to remove dust or dirt from the lens. This may cause a fire due to excessive heat inside the projector.



Warning: Do not clean the lens if the projector is warming up as this may cause the lens' surface film to peel off.



Warning: Do not wipe or tap the lens with a hard object.



To avoid electric shock, the unit and its peripherals must be properly grounded (earthed).

# INTRODUCTION

Thank you for purchasing an Optoma projector. For full list of features please visit the product page on our website, where you will also find additional information and documentation such as FAQs.

## Package overview

Carefully unpack and verify that you have the items listed below under standard accessories. Some of the items under optional accessories may not be available depending on the model, specification and your region of purchase. Please check with your place of purchase. Some accessories may vary from region to region.

The warranty card is only supplied in some specific regions. Please consult your dealer for detailed information.

## Standard accessories

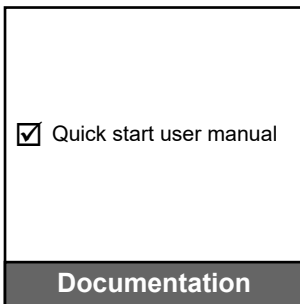
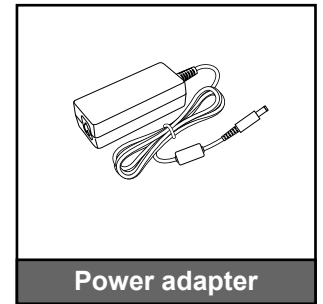
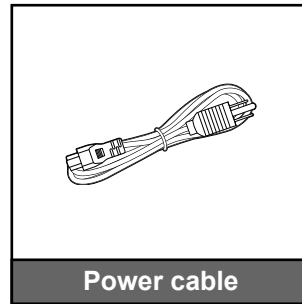
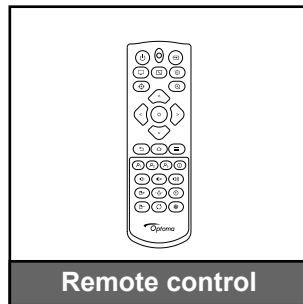
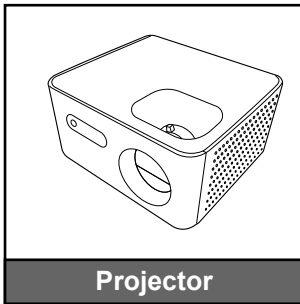

### Note:

- For access to the setup information, user manual, warranty information, and product updates – please scan the QR Code or visit the following URL:  
<https://www.optoma.com/support/download>
- The accessories may vary depending on the region.



# INTRODUCTION

## Product overview

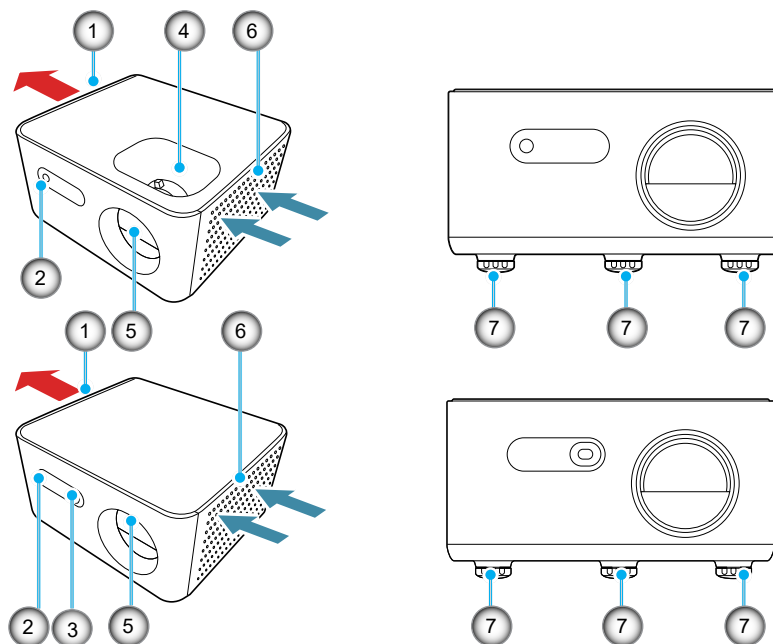

### Note:

- Do not block projector intake and exhaust vents.
- When operating the projector in an enclosed space, allow at least 30 cm clearance around the intake and exhaust vents.

No	Item	No	Item
1.	Ventilation (outlet)	5.	Lens
2.	IR receiver	6.	Ventilation (inlet)
3.	ToF (Time of Flight) sensor	7.	Tilt-Adjustment feet
4.	Focus ring/Zoom lever		

# INTRODUCTION

## Connections

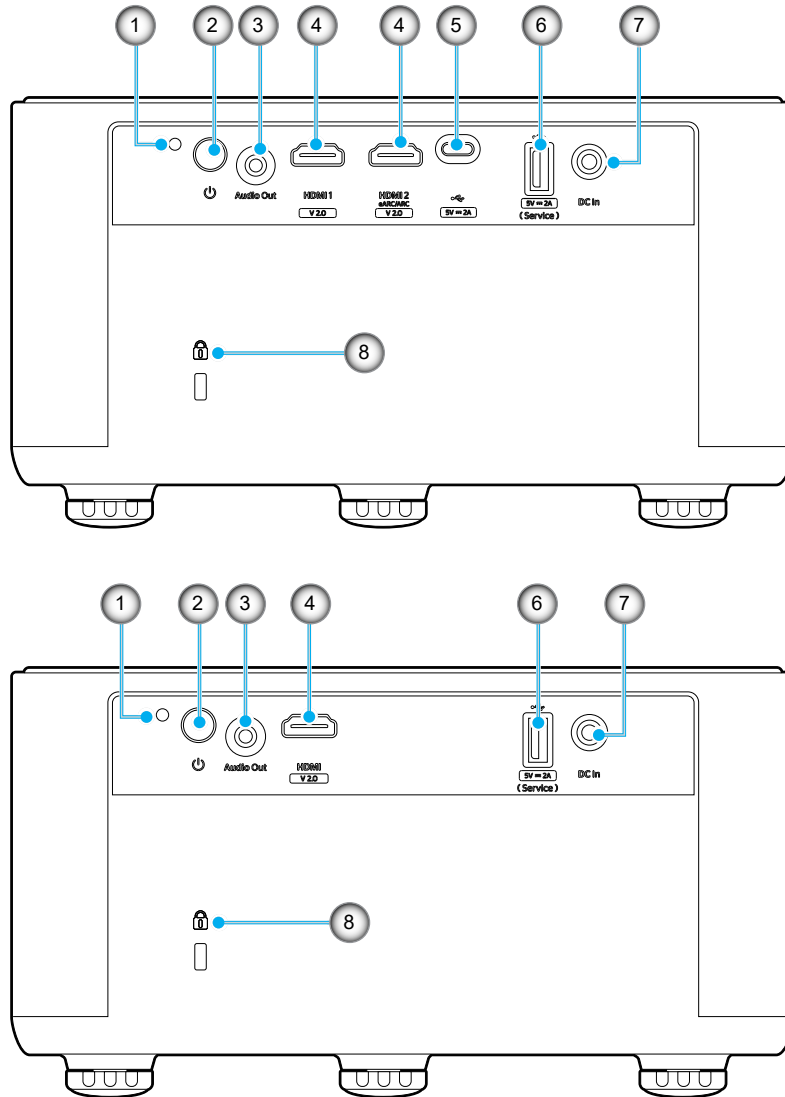

No	Item	No	Item
1.	LED indicator	5.	USB Type C connector
2.	Power button	6.	USB Power Out (5V $\overline{\text{--}}$ 2A) connector
3.	Audio Out connector	7.	DC jack
4.	HDMI connector	8.	Kensington™ lock port

### Note:

- Supported signal modes vary by model and sales region.

# INTRODUCTION

## Remote control

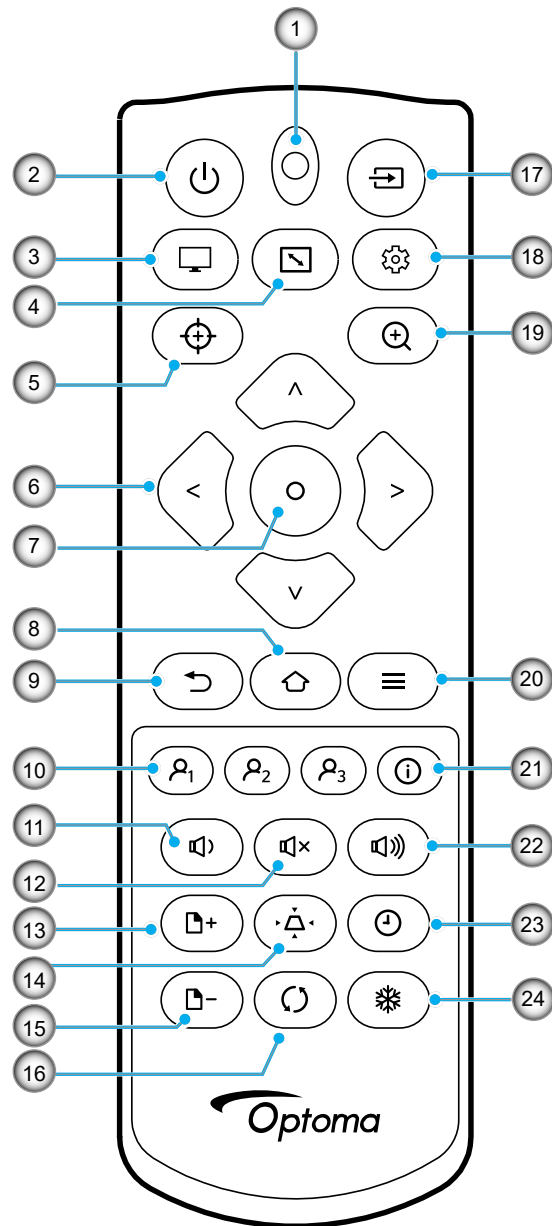

No	Item	No	Item
1.	LED indicator	13.	Page Up
2.	Power On/Off	14.	Keystone Correction
3.	Picture Mode	15.	Page Down
4.	Aspect Ratio	16.	Re-sync
5.	Focus	17.	Source
6.	Four directional select keys	18.	Settings/Setup Menu
7.	Enter	19.	Zoom
8.	Home	20.	Menu
9.	Return	21.	Information
10.	User 1/2/3 (assignable)	22.	Volume +
11.	Volume -	23.	Sleep Timer
12.	Mute	24.	Freeze

# INTRODUCTION

**Note:**

- *Some buttons may have no function for models that do not support these features.*
- *Before using the remote control for the first time, remove the transparent insulation tape. See page 18 for battery installation.*
- *The inclusion of the battery for the remote control may vary depending on the region.*
- *The remote control may vary depending on the region.*

# SETUP AND INSTALLATION

## Installing the projector

Your projector is designed to be installed in one of four possible positions.

Your room layout or personal preference will dictate which installation location you select. Take into consideration the size and position of your screen, the location of a suitable power outlet, as well as the location and distance between the projector and the rest of your equipment.

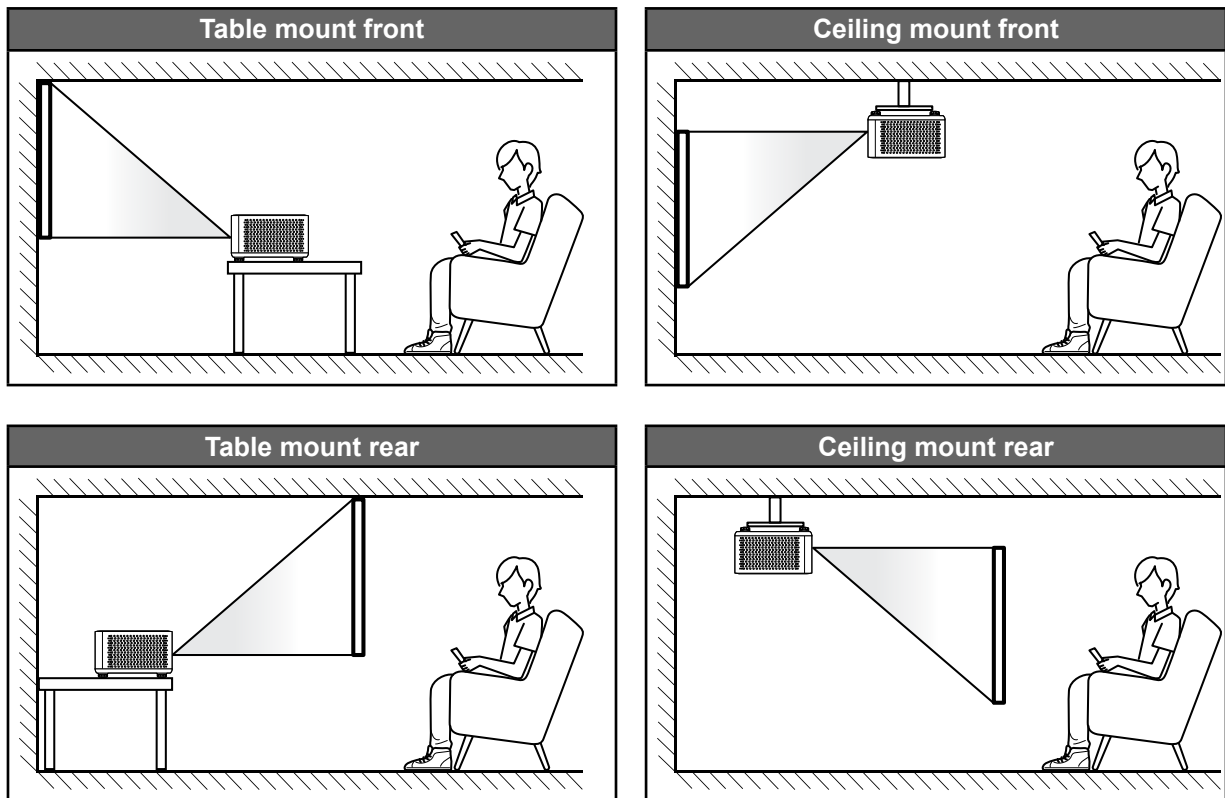

Projector should be placed flat on a surface and 90 degrees / perpendicular to the screen.

- How to determine projector location for a given screen size, please refer to distance table on pages 44~45.
- How to determine screen size for a given distance, please refer to distance table on pages 44~45.

**Note:** As the projector is moved farther away from the screen, the size of the projected image increases and the vertical offset also increases in proportion.

# SETUP AND INSTALLATION

## Projector installation notice

- Allow at least 30 cm clearance around the exhaust vent.

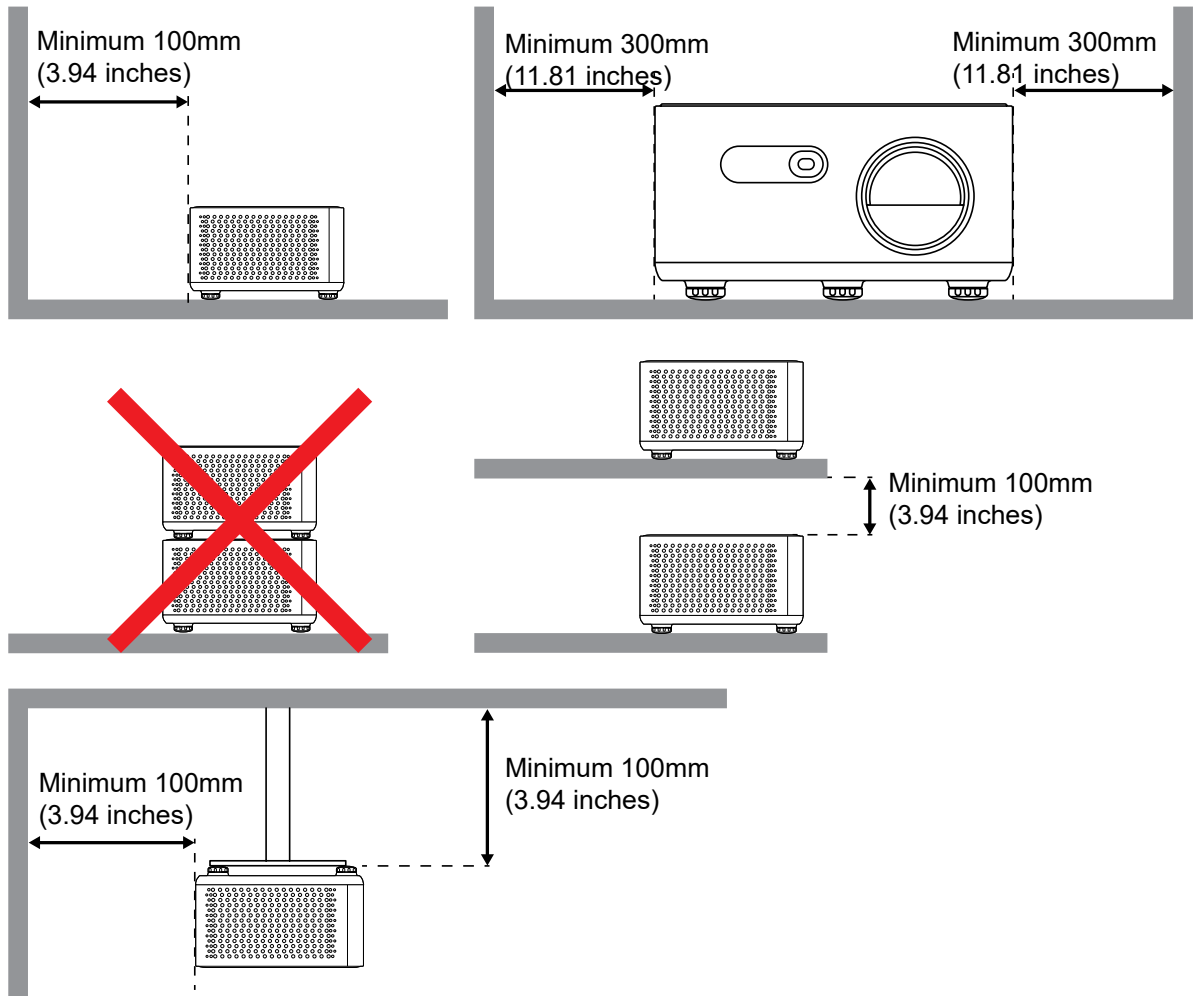

- Ensure that the intake vents do not recycle hot air from the exhaust vent.
- When operating the projector in an enclosed space, ensure that the surrounding air temperature within the enclosure does not exceed operation temperature while the projector is running, and the air intake and exhaust vents are unobstructed.
- All enclosures should undergo a certified thermal evaluation to ensure that the projector does not recycle exhaust air, as this may cause the device to shut down even if the enclosure temperature remains within the acceptable operation temperature range.

# SETUP AND INSTALLATION

## Connecting sources to the projector

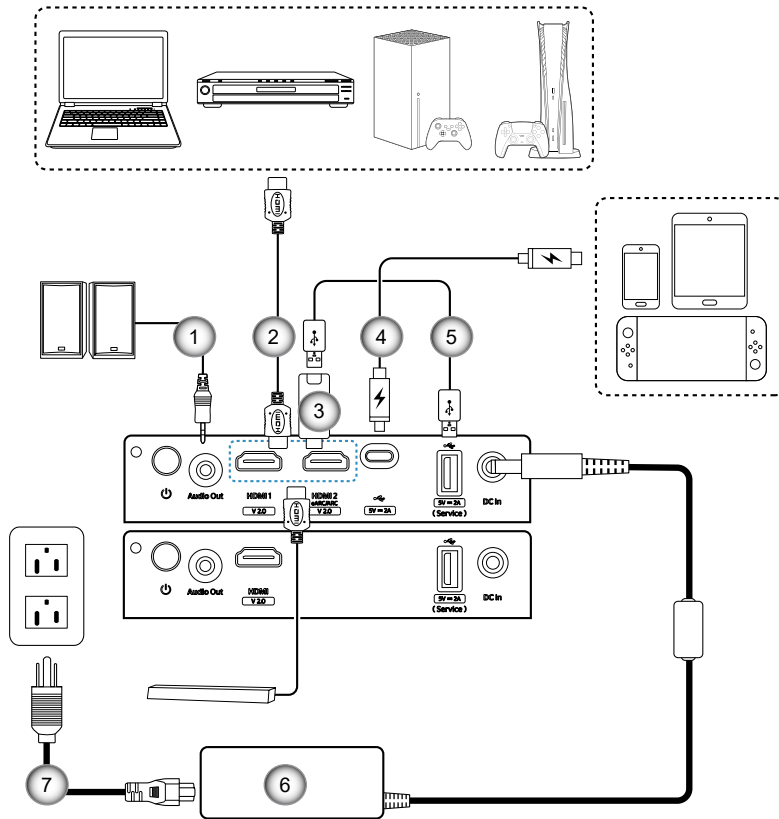

No	Item	No	Item
1.	Audio Out cable	5.	USB power cable
2.	HDMI cable	6.	Power adapter
3.	HDMI dongle	7.	Power cable
4.	USB Type C cable		

**Note:**

- *To ensure the best image quality and avoid connection errors, we recommend the use of High Speed or Premium Certified HDMI cables up to 5 meters.*

# SETUP AND INSTALLATION

## Adjusting the projector image

### Image height

The projector is equipped with elevator feet for adjusting the image height.

1. Locate the adjustable foot you wish to adjust on the underside of the projector.
2. Rotate the adjustable foot clockwise or counterclockwise to raise or lower the projector.

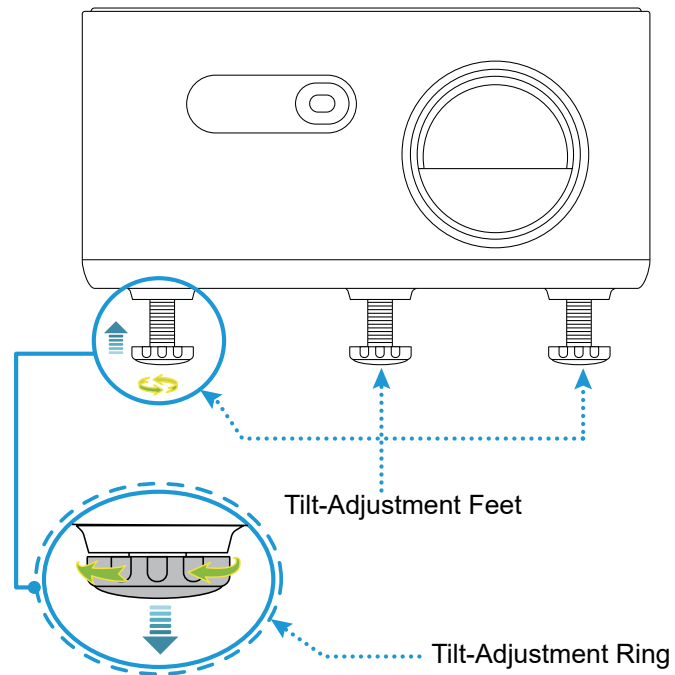

# SETUP AND INSTALLATION

## Zoom and focus

### 4K Standard Model

- To adjust the image size, turn the zoom lever clockwise or counterclockwise to increase or decrease the projected image size.
- To adjust the focus, turn the focus ring clockwise or counterclockwise until the image is sharp and legible.

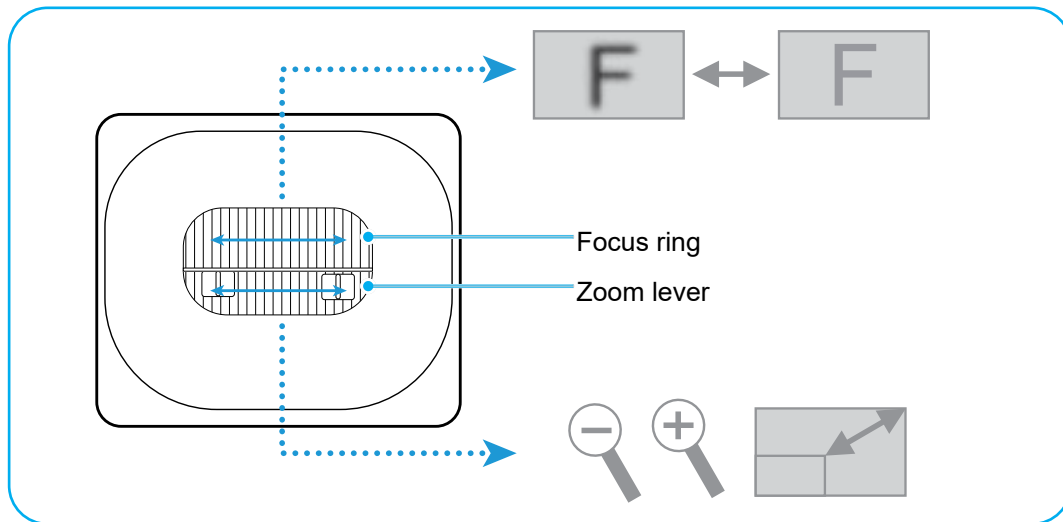

### 4K Advanced Model

The settings for zoom and focus are located in the OSD menu. Please go to Display > Focus Setting or Display > Zoom Setting to access the instruction menu.

- To adjust the image size, press the  $\wedge / \vee$  button repeatedly until the image size meets your needs.
- To adjust the image focus manually, press the  $< / >$  button repeatedly until the image is sharp and legible.
- To focus the image automatically, press the  $\circ$  (Enter) button.

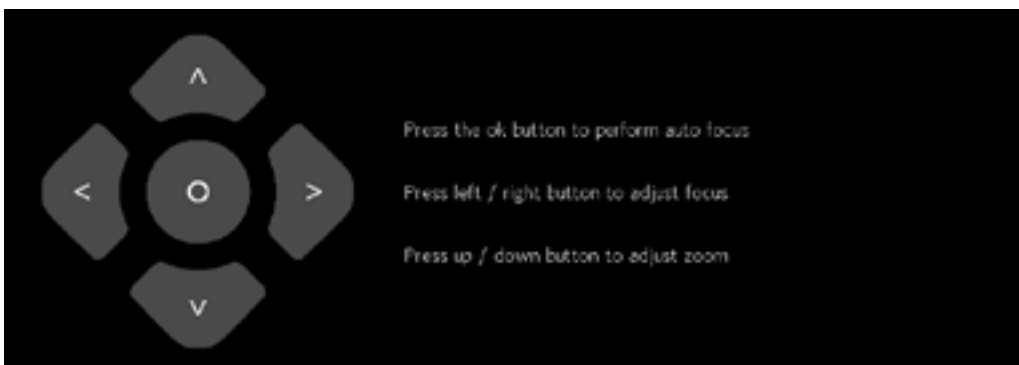

# SETUP AND INSTALLATION

## Remote setup

Two AAA size batteries are supplied for the remote control.

1. Remove the battery cover on the back of the remote control.
2. Insert AAA batteries in the battery compartment as illustrated.
3. Replace back cover on remote control.

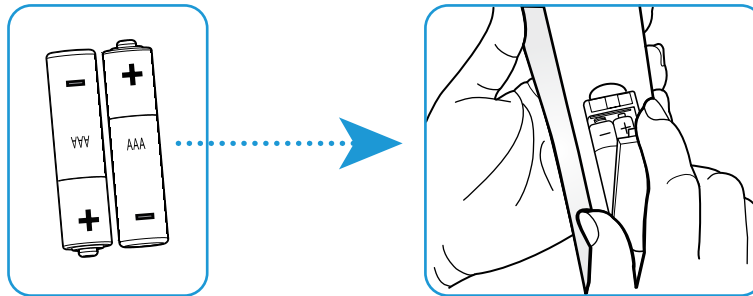

**CAUTION:** To ensure safe operation, please observe the following precautions:

- Replacement of a battery with an incorrect type that can defeat a safeguard (AAA size battery type);
- Disposal of a battery into fire or a hot oven, or mechanically crushing or cutting of a battery, that can result in an explosion;
- Leaving a battery in an extremely high temperature surrounding environment that can result in an explosion or the leakage of flammable liquid or gas; and
- A battery subjected to extremely low air pressure that may result in an explosion or the leakage of flammable liquid or gas.

**Note:** *The inclusion of the battery and the battery type for the remote control may vary depending on the region.*

# SETUP AND INSTALLATION

## Effective range

Infra-Red (IR) remote control sensor is located on the top and front sides of the projector. Ensure that the remote control is held at an angle 30 degrees perpendicular to the projector's IR remote control sensor to ensure correct functionality. The distance between the remote control and the sensor should not be longer than 8 meters (26 feet).

- Make sure that there are no obstacles between the remote control and the IR sensor on the projector that might obstruct the infra-red beam.
- Make sure the IR transmitter of the remote control is not being shined by sunlight or fluorescent lamps directly.
- Please keep the remote controller away from fluorescent lamps for over 2 m or the remote controller may malfunction.
- If the remote control is close to Inverter-Type fluorescent lamps, it might become ineffective from time to time.
- If the remote control and the projector are within a very short distance of one another, the remote control might become ineffective.

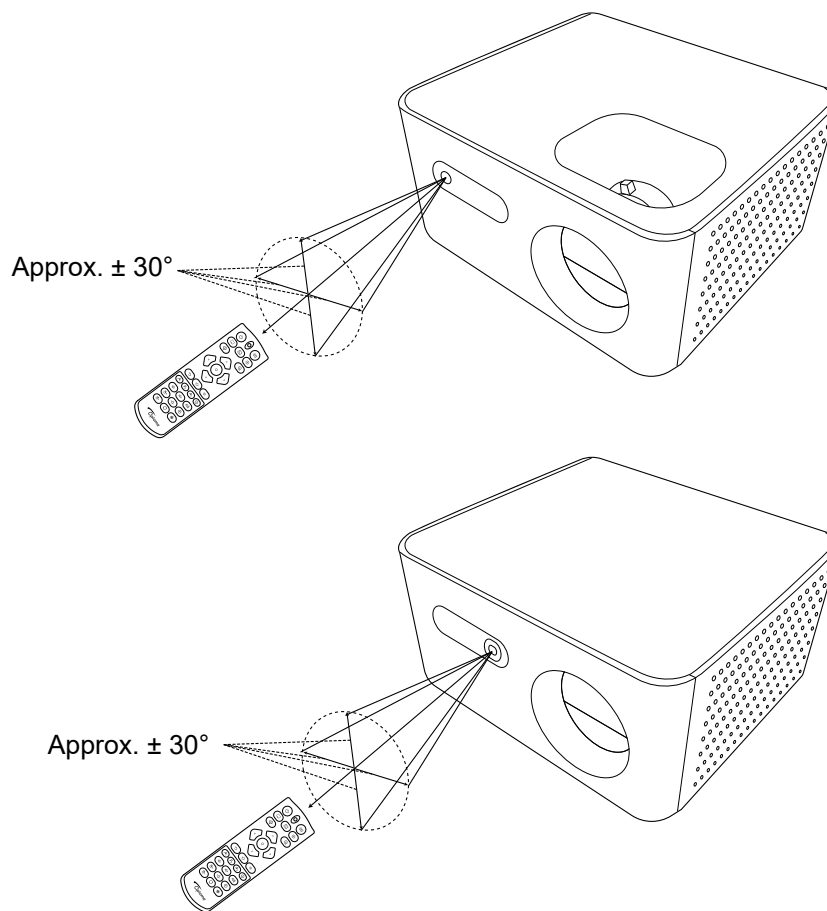

# USING THE PROJECTOR

## Powering on/off the projector

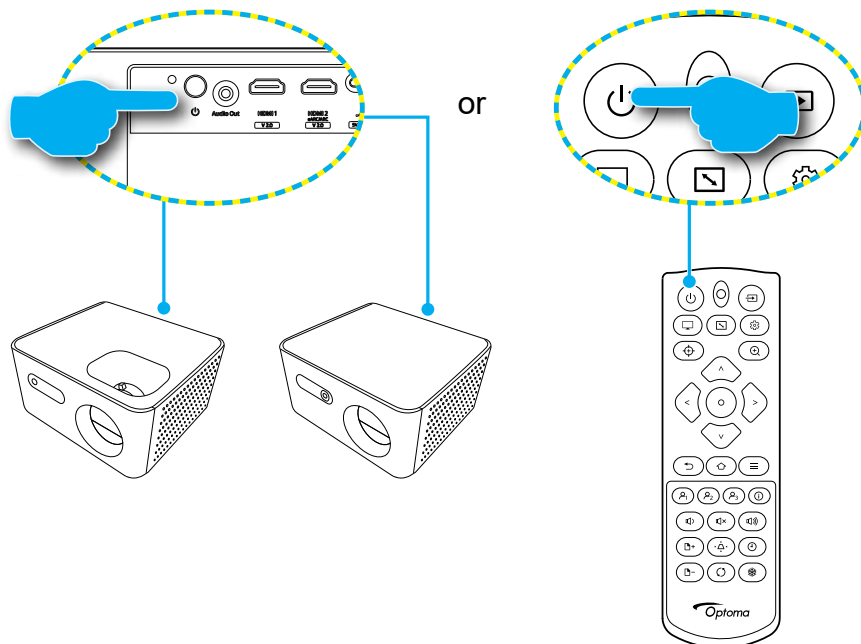

### Powering on



1. Securely connect the power lead and signal/source cable. When connected, the Power LED will turn red.
2. Turn on the projector by pressing the  button on the back side of the projector or on the remote control.
3. A start up screen will be displayed and the Power LED turns blue.

**Note:** The first time the projector is turned on, you will be prompted to select the preferred language, projection orientation, and other settings.

### Powering off

1. Turn off the projector by pressing the  button on the back side of the projector or on the remote control. The following message will be displayed.



2. Press the  button again to confirm, otherwise the message will disappear after 15 seconds. When you press the  button for the second time, the projector will shut down.
3. When the Power LED turns solid red, this indicates the projector has entered standby mode.
4. Disconnect the power lead from the electrical outlet and the projector.

**Note:** It is not recommended that the projector is turned on immediately, right after a power off procedure.

# USING THE PROJECTOR

## Selecting an input source

Turn on the connected source that you want to display on the screen, such as computer, notebook, video player, etc. The projector will automatically detect the source. If multiple sources are connected, press the  button on the remote control to select the desired input.

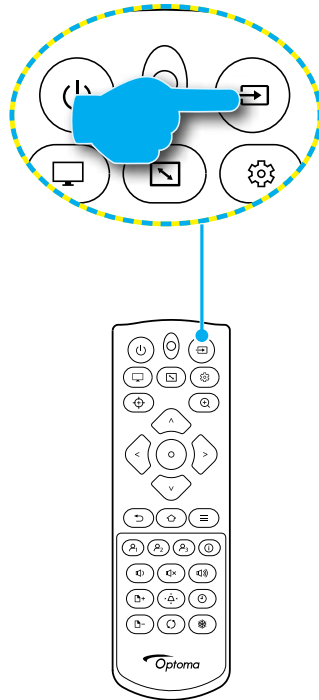

# USING THE PROJECTOR

## Menu navigation and features

The projector has multilingual on-screen display menus that allow you to make image adjustments and change a variety of settings. The projector will automatically detect the source.

1. To open the OSD menu, press  $\equiv$  on the remote control.
2. When OSD is displayed, press  $\langle / \rangle$  to select a main menu.
3. Press  $\wedge / \vee$  to select a desired sub menu and then press  $\bigcirc$  to view further settings. Adjust the settings by using  $\wedge / \vee / \langle / \rangle$ .
4. To save and exit, press  $\equiv$  or  $\rightarrow$ . The OSD menu will close and the projector will automatically save the new settings.

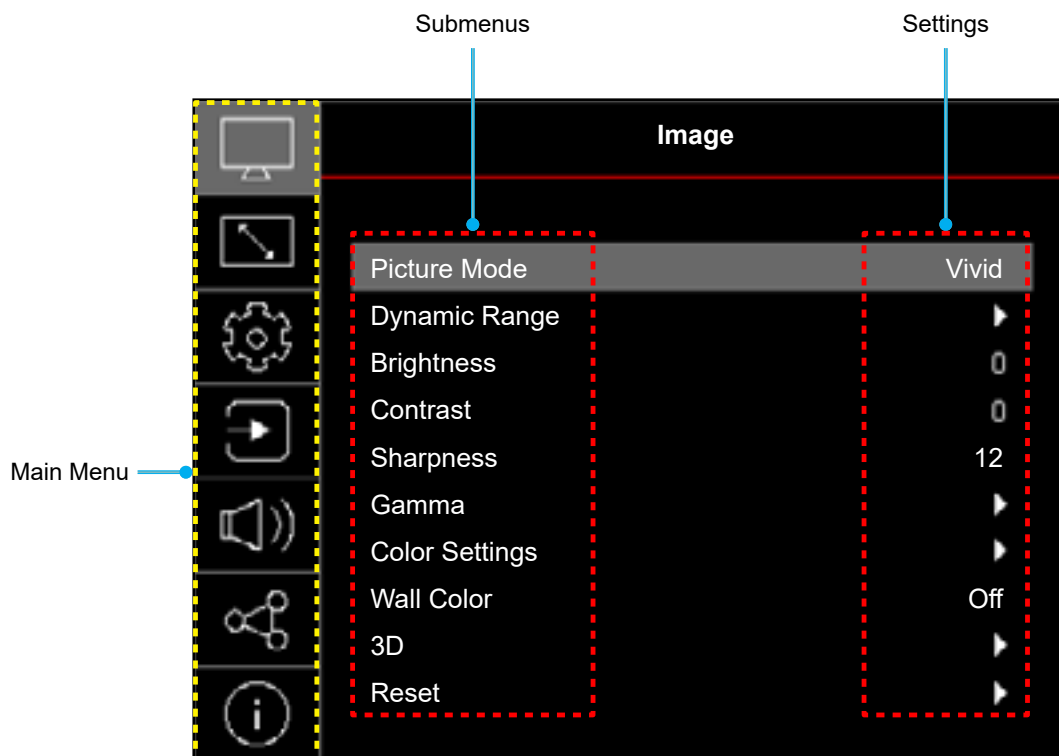

# USING THE PROJECTOR

## OSD menu

**Note:** The OSD menu tree items and features are subject to models and region. Optoma reserves the right to add or remove items to improve product performance without notice.

### 1. Main menu: Image

Main Menu	Sub Menu	Sub Menu 2	Sub Menu 3	
Image	Picture Mode	Vivid		
		HDR		
		HLG		
		Cinema		
		Game		
		Reference		
		Bright		
		ISF Day		
		ISF Night		
		ISF 3D		
	Dynamic Range	HDR/ HLG	Auto	
			Off	
		HDR Brightness	1 ~ 5	
	Brightness	-50 ~ 50		
	Contrast	-50 ~ 50		
	Sharpness	1 ~ 15		
	Gamma	Film		
		Graphics		
		1.8		
		2.0		
		2.2		
		2.4		
		(EOTF-Hide)		
	(3D-Hide)			
	Color Settings	Color	-50 ~ 50	
		Tint	-50 ~ 50	
		Color Temperature	Warm	
			Standard	
			Cool	
			Cold	
		CMS	Color	
			Hue	
			Saturation	
Luminance				
Reset				
Color Space		Auto		
		RGB (0~255)		
	RGB (16~235)			
	YUV			

# USING THE PROJECTOR

Main Menu	Sub Menu	Sub Menu 2	Sub Menu 3	
Image	Wall Color	Off		
		Blackboard		
		Light Yellow		
		Light Green		
		Light Blue		
		Pink		
		Grey		
	3D	3D Mode	Off	
			On	
		3D Format	Frame Sequential	
		3D Sync Invert	Off	
			On	
	Reset	Cancel		
		OK		
	Reset			

## Picture Mode

There are several predefined display modes that you can choose from to suit your viewing preference. Each mode has been fine-tuned by our expert colour team to ensure superior colour performance for wide range of content.

- Vivid**  
 Selecting this mode balances colour saturation and brightness for a brighter display. Choose this mode for setups with ambient lighting, or where brighter images/presentations are necessary.
- HDR/HLG**  
 Decodes and displays High Dynamic Range (HDR)/Hybrid Log Gamma (HLG) content for the deepest blacks, brightest whites, and vivid cinematic color using REC.2020 color gamut. This mode will be automatically enabled if HDR/HLG is set to Auto (and HDR/HLG Content is sent to projector – 4K UHD Blu-ray, 1080p/4K UHD HDR/HLG Games, 4K UHD Streaming Video). While HDR/HLG mode is active, other display modes (Cinema, Reference, etc.) cannot be selected as HDR/HLG delivers color that is highly accurate, exceeding the color performance of the other display modes.
- Cinema**  
 Provides the best balance of detail and colors for watching movies.
- Game**  
 Optimises your projector for maximum contrast and vivid colours allowing you to see shadow detail when playing video games.
- Reference**  
 This mode reproduces colours as close as possible the image the way the movie director intended. Color, color temperature, brightness, contrast and gamma settings are all configured to Rec.709 color gamut. Select this mode for the most accurate colour reproduction when watching movies.
- Bright**  
 This mode is suitable for environments where extra-high brightness is required, such as using the projector in well-lit rooms.
- ISF Day/ISF Night/ISF 3D**  
 The ISF calibration menu is password protected and only accessible by authorized ISF calibrators. We recommend that setup and calibration be performed by an ISF certified installation technician.

# USING THE PROJECTOR

## Dynamic Range

- **HDR/HLG**  
Configures the High Dynamic Range (HDR)/Hybrid Log Gamma (HLG) setting and its effect when displaying video from 4K Blu-ray players and streaming devices.
  - Auto: Automatically detects HDR/HLG signal.
  - Off: Turns off HDR/HLG Processing. When setting to Off, the projector will NOT decode HDR/HLG content.
- **HDR Brightness**  
The projector can automatically adjust the brightness levels of your image according to the input source. You can also manually select a brightness level to display better picture quality. When the value is higher, the image becomes brighter; when the value is lower, the image becomes darker.

## Brightness

Adjust the brightness of the image.

## Contrast

The contrast controls the degree of difference between the lightest and darkest parts of the picture.

## Sharpness

Adjusts the sharpness of the image.

## Gamma

Sets up gamma curve type. After the initial setup and fine tuning is completed, utilize the Gamma Adjustment steps to optimize your image output.

- **Film**  
For home theater.
- **Graphics**  
For PC/Photo source.
- **1.8/2.0/2.2/2.4**  
For specific PC/Photo source.

## Color Settings

- **Color**  
Adjusts the image from black and white to fully saturated color.
- **Tint**  
Adjusts the color balance of red and green.

# USING THE PROJECTOR

- **Color Temperature**  
Selects a color temperature from Warm, Standard, Cool, and Cold.
- **CMS**  
Selects the following options:
  - Color: Adjusts the red, green, blue, cyan, yellow, magenta, and white level of the image.
  - Hue: Adjusts the color balance of red and green.
  - Saturation: Adjusts the image from black and white to fully saturated color.
  - Luminance: Adjusts the luminance of the selected color.
  - Reset: Resets all of the settings to the factory defaults.
- **Color Space**  
Selects an appropriate color matrix type from the following: Auto, RGB (0-255), RGB (16-235), and YUV.

## Wall color

Designed to adjust the colors of the projected image when projecting on to a wall without a screen. There are several predefined modes that you can choose from to suit the colour of your wall. Each mode has been fine-tuned by our expert colour team to ensure superior color performance.

**Note:** For accurate color reproduction, we recommend using a screen.

## 3D

**Note:** This projector is a 3D ready projector with DLP-Link 3D solution.

**Note:** Please ensure that 3D glasses are in use for DLP-Link 3D content before enjoying your video.

**Note:** This projector supports frame sequential (page-flip) 3D via HDMI1/HDMI2 ports.

**Note:** To enable 3D mode, the input frame rate should be set to 60Hz only, lower or higher frame rate is not supported.

**Note:** To reach the best performance, resolution 1920x1080 is recommended, please note that 4K (3840x2160) resolution is not supported in 3D mode.

- **3D Mode**  
Use this option to disable or enable the 3D function.
- **3D Format**  
Use this option to select the Frame Sequential format.
- **3D Sync Invert**  
Use this option to enable or disable the 3D sync invert function.
- **Reset**  
Resets all of the 3D settings to the factory defaults.

## Reset

Resets all of the adjustments you've made in the Image menu to the factory defaults.

# USING THE PROJECTOR

## 2. Main menu: Display

Main Menu	Sub Menu	Sub Menu 2	Sub Menu 3	
Display	Projection Orientation	Front		
		Rear		
		Ceiling-Top		
		Rear-Top		
	Light Source Mode	Eco.		
		Power		100%
				90%
				80%
				70%
	Dynamic Black	Off		
		On		
	Low Latency Mode	Off		
		On		
	Aspect Ratio	4:3		
		16:9		
		21:9		
		1:1		
		Native		
		Auto		
	Focus Setting (4K Advanced Model only)	Auto Focus		Off
				On
	Zoom Setting (4K Advanced Model only)	Focus		+/-
		Optical Zoom		+/-
	Geometric Correction	Auto Keystone (4K Advanced Model only)		Off
				On
		V Keystone		-40 ~ 40
		H Keystone		-40 ~ 40
		Four Corner Adjustment		
		5 x 3 Warp		
	Digital Zoom (4K Standard Model only)	Reset		
	Digital Zoom (4K Standard Model only)	Zoom		-5~25
	Image Shift	H		-100 ~ 100
V			-100 ~ 100	
Reset				

### Projection Orientation

Selects a preferred projection orientation between Front, Rear, Ceiling-Top, and Rear-Top.

# USING THE PROJECTOR

## Light Source Mode

Selects a light source mode depending on the installation requirements.

## Dynamic Black

Enable this feature to automatically adjust the picture brightness for optimum contrast performance.

## Low Latency Mode

Enable this feature to reduce response times (input latency) during gaming. The following image settings will be disabled when this mode is enabled: 3D, Aspect Ratio, Geometric Correction, Digital Zoom, Image Shift. See below for more information.

- The input lag by signals is described in the following table.
- The values in the table can vary slightly.

Source Timing	Low Latency Mode	Output Timing	Output Resolution	Input Lag
1080p60	On	1080p60Hz	1080p	18.3ms
1080p120	On	1080p120Hz	1080p	9.2ms
1080p240	On	1080p240Hz	1080p	4.6ms
4K60	On	4K60Hz	4K	18.3ms
1080p60	Off	1080p60Hz	1080p	33.8ms
1080p120	Off	1080p120Hz	1080p	17ms
1080p240	Off	1080p240Hz	1080p	8.6ms
4K60	Off	4K60Hz	4K	33.7ms

## Aspect Ratio

Select the aspect ratio of the displayed image between the following options:

- **4:3**  
This format is for 4:3 input sources.
- **16:9**  
This format is for 16:9 input sources, like HDTV and DVD enhanced for Wide screen TV.
- **21:9**  
This format is for 21:9 input source, like HDTV and DVD enhanced for Wide screen TV.
- **1:1**  
Scales the image with a 1:1 aspect ratio.
- **Native**  
This format displays the original image without any scaling.
- **Auto**  
Automatically selects the appropriate display format.



# USING THE PROJECTOR

16:9 screen	480i/p	576i/p	1080i/p	720p	PC
4:3	Scale to 2880x2160.				
16:9	Scale to 3840x2160.				
21:9	Scale to 3840x1645.				
1:1	Scale to 2160x2160.				
Native	<ul style="list-style-type: none"> <li>1:1 mapping centered.</li> <li>No scaling will be made. The image is displayed with the resolution based on the input source.</li> </ul>				
Auto	<ul style="list-style-type: none"> <li>If the input source is 4:3, the image will be scaled to 2880x2160.</li> <li>If the input source is 16:9, the image will be scaled to 3840x2160.</li> <li>If the input source is 16:10, the image will be scaled to 3456x2160.</li> </ul>				

Auto	Input resolution		Auto/Scale	
	H-resolution	V-resolution	3840	2160
4:3	640	480	2880	2160
	800	600	2880	2160
	1024	768	2880	2160
	1280	960	2880	2160
	1400	1050	2880	2160
	1600	1200	2880	2160
Wide Laptop	1280	720	3840	2160
	1280	768	3600	2160
	1280	800	3456	2160
SDTV	720	576	2700	2160
	720	480	3240	2160
HDTV	1280	720	3840	2160
	1920	1080	3840	2160

## Focus Setting

(4K Advanced Model only)

- Auto Focus**  
 Automatically focus the projected image by pressing the  (Enter) button.
- Focus**  
 Manually adjusts the image focus by pressing the  button.

# USING THE PROJECTOR

## Zoom Setting

(4K Advanced Model only)

Reduces or magnifies image sizes on the projection screen. Digital Zoom is not the same as optical zoom and can result in degradation of image quality.

- **Optical Zoom**

Adjusts the image size by pressing the  $\wedge / \vee$  button.

- **Digital Zoom**

Displays the digital zoom setting menu for adjustments.

**Note:** Zoom settings are retained on power cycle of the projector.

## Geometric Correction

- **Auto Keystone**

(4K Advanced Model only)

Automatically corrects the distorted image when the projector is not aligned with the screen.

Auto Keystone supports the following distances (measured from the front cover of the projector to the wall) and angles:

- 100cm to 250cm: Horizontal and vertical correction up to  $\pm 25^\circ$
- 250cm to 320cm: Horizontal and vertical correction up to  $\pm 20^\circ$

- **V Keystone**

Adjusts image distortion vertically and make a squarer image. Vertical keystone is used to correct a keystone image shape in which the top and bottom borders of the image are unequal in length. This is intended for use with vertically on-axis applications.

- **H Keystone**

Adjusts image distortion horizontally and make a squarer image. Horizontal keystone is used to correct a keystone image shape in which the left and right borders of the image are unequal in length. This is intended for use with horizontally on-axis applications.

- **Four Corner Adjustment**

This setting allows adjustments for each corner to make a square image when the projection surface is not level.

- **5 x 3 Warp**

Adjusts the image to align with the border of the projection surface (screen) or to eliminate image distortion (caused by an uneven surface).

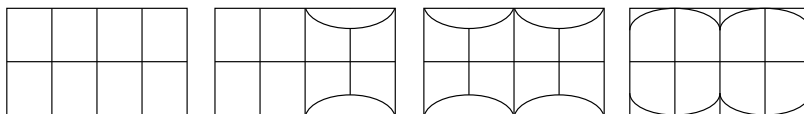

- **Reset**

Resets all the settings in the Geometric Correction menu to the factory defaults.

# USING THE PROJECTOR

## Digital Zoom

(4K Standard Model only)

Displays the digital zoom setting menu for adjustments.

**Note:** *Zoom settings are retained on power cycle of the projector.*

## Image Shift

Adjusts the projected image position horizontally (H) or vertically (V).

## Reset

Resets all the settings in the Display menu to the factory defaults.

The following settings will still remain: Projection Orientation, Light Source Mode, Geometric Correction, Image Shift.

# USING THE PROJECTOR

## 3. Main menu: Device Setup

Main Menu	Sub Menu	Sub Menu 2	Sub Menu 3
Device Setup	Test Pattern	Green Grid	
		Magenta Grid	
		White Grid	
		White	
		Off	
	Language	English	
		عربي	
		Čeština	
		Dansk	
		Nederlands	
		العربية	
		Suomi	
		Français	
		Deutsch	
		ελληνικά	
		Magyar	
		Bahasa Indonesia	
		Italiano	
		日本語	
		한국어	
		Norsk	
		Polski	
		Português	
		Română	
		Русский	
		簡體中文	
		Español	
		Svenska	
	ไทย		
	繁體中文		
	Türkçe		
	Tiếng Việt		
	Menu Settings	Menu Location	
			Top right
			Center
			Bottom left
			Bottom right
Menu Timer			Off
			5s
			10s
			20s
			30s
			60s

# USING THE PROJECTOR

Main Menu	Sub Menu	Sub Menu 2	Sub Menu 3
Device Setup	Menu Settings	Information Hide	Off
			On
	High Altitude		Off
			On
	Power Settings	Direct Power On	Off
			On
		Signal Power On	Off
			On
		Auto Power Off (min.)	0 ~ 180
		Sleep Timer (min.)	0 ~ 990
		USB-A power (4K Standard Model only)	Auto
	On		
	Off		
	Security	Security	Off
			On
		Security Timer	Month
			Day
	Change Password	Hour	
	Startup Logo	Logo	Default
			Neutral
	Background Color		None
			Blue
			Red
			Green
Gray			
Reset	Reset OSD	Cancel	
		OK	
	Reset All Settings	Cancel	
		OK	

## Test Pattern

Selects a suitable test pattern.

## Language

Sets the language for the OSD menus.

## Menu Settings

- **Menu Location**  
Sets the OSD menu position.

# USING THE PROJECTOR

- **Menu Timer**  
Sets the duration the OSD menu stays visible on the screen.
- **Information Hide**  
Enable this function to hide the information message.

## High Altitude

When “On” is selected, the fans will spin faster. This feature is useful in high altitude areas where the air is thin.

## Power Settings

- **Direct Power On**  
Choose “On” to activate Direct Power mode. The projector will automatically power on when AC power is supplied, without pressing the “Power” key on the projector or remote control.
- **Signal Power On**  
Choose “On” to activate Signal Power mode. The projector will automatically power on when a signal is detected, without pressing the “Power” key on the projector or remote control.  
**Note:** *This function is applicable with HDMI source.*
- **Auto Power Off (min.)**  
Sets the countdown timer interval by 1-minute increments. The countdown timer will start when there is no signal being sent to the projector. The projector will automatically power off when the countdown finishes.  
**Note:** *Adjusting power-related functions may increase energy consumption.*
- **Sleep Timer (min.)**  
Sets the countdown timer interval by 30-minute increments. The countdown timer will start, with or without a signal being sent to the projector. The projector will automatically power off when the countdown finishes.  
**Note:** *The Sleep Timer is reset every time the projector is powered off.*
- **USB-A power**  
(4K Standard Model only)
  - Auto: When Bright Mode is selected, the USB-A power supply will automatically turn off. If Bright Mode is not in use, the USB-A port supplies power normally.
  - On: When Bright Mode is selected, the USB-A power supply will remain active but with reduced wattage and brightness.
  - Off: The USB-A power supply will always remain off.

# USING THE PROJECTOR

## Security

- **Security**  
Enable this function to prompt for a password before using the projector.
  - On: Choose “On” to use security verification when the turning on the projector.
  - Off: Choose “Off” to be able to switch on the projector without password verification.
- **Security Timer**  
Select the time (Month/Day/Hour) function to set the number of hours the projector can be used. Once this time has elapsed you will be requested to enter your password again.
- **Change Password**  
Use to set or modify the password that is prompted when turning the projector on.

## Startup Logo

- **Logo**  
Use this function to set the desired startup screen. If changes are made, they will take effect the next time the projector is powered on.
  - Default: Displays the default startup screen.
  - Neutral: Logo is not displayed on the startup screen.

## Background Color

Use this function to display a blue, red, green, grey color, none, or logo screen when no signal is available.

**Note:** *If the background color is set to “None”, then the background color is black.*

## Reset

- **Reset OSD**  
Resets all the settings in the Device Setup menu to their factory defaults.  
The following settings will still remain: Language, Security.
- **Reset All Settings**  
Resets all the settings to the factory defaults.  
The following settings will still remain: Projection Orientation, Audio Output, Digital Output Format.

# USING THE PROJECTOR

## 4. Main menu: Input Settings

Main Menu	Sub Menu	Sub Menu 2	Sub Menu 3	
Input Settings	Auto Source (4K Advanced Model only)		Off	
			On	
	Auto Input Switch (4K Advanced Model only)		Off	
			On	
	HDMI CEC Settings	HDMI Link		Off
				On
		Power On Link		Mutual
				PJ --> Device
				Device --> PJ
		Power Off Link		Mutual
			PJ --> Device	
			Device --> PJ	
	Reset		No	
			Yes	

### Auto Source

(4K Advanced Model only)

Choose this option to let the projector automatically find an available input source.

### Auto Input Switch

(4K Advanced Model only)

When an HDMI input signal is detected, the projector will automatically switch to it as the input source.

### HDMI CEC Settings

**Note:** When you connect HDMI CEC-compatible devices to the projector with HDMI cables, you can control them on the same power on or power off status using the HDMI Link control feature in the projector's OSD. This lets one device or multiple devices in a group power on or power off via HDMI Link Feature in a typical configuration, your DVD player may be connected to the projector through an amplifier or home theater system.

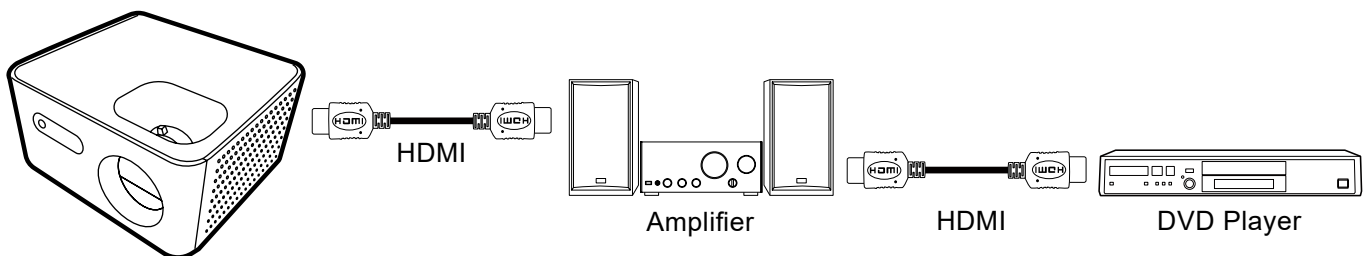

- **HDMI Link**  
Enables/Disables the HDMI Link function.

# USING THE PROJECTOR

- **Power On Link**  
Sets the CEC power command.
  - Mutual: Both the projector and CEC device will be turned on simultaneously.
  - PJ → Device: The CEC device will be turned on only after the projector is switched on.
  - Device → PJ: The projector will be switched on only after the CEC device is turned on.
- **Power Off Link**  
Sets the CEC power command.
  - Mutual: Both the projector and CEC device will be turned off simultaneously.
  - PJ → Device: The CEC device will be turned off only after the projector is switched off.
  - Device → PJ: The projector will be switched off only after the CEC device is turned off.

## Reset

Resets all the settings in the Input Settings menu to the factory defaults.

# USING THE PROJECTOR

## 5. Main menu: Audio

Main Menu	Sub Menu	Sub Menu 2	Sub Menu 3
Audio	Volume	0 - 100	
	Mute	Off	
		On	
	Audio Output (4K Advanced Model only)	Internal Speaker	
		Digital Output	
	Digital Output Format (4K Advanced Model only)	Auto	
		LPCM	
		Multi-Channel	
		Multi-Channel +	
	Reset		

### Volume

Adjusts the volume level.

### Mute

Use this option to temporarily turn off the sound.

**Note:** "Mute" function affects both internal and external speaker volume.

### Audio Output

(4K Advanced Model only)  
Sets the audio output source.

### Digital Output Format

(4K Advanced Model only)  
Sets the digital output format.

- **Auto**  
Automatically selects a suitable output format for the audio system.
- **LPCM**  
Supports 2-channel audio output.
- **Multi-Channel**  
Supports 5.1-channel audio output.
- **Multi-Channel+**  
Supports Dolby Atmos audio output.

# USING THE PROJECTOR

## **Reset**

Resets all the settings in the Audio menu to the factory defaults.

# USING THE PROJECTOR

## 6. Main menu: Control

Main Menu	Sub Menu	Sub Menu 2	Sub Menu 3
Control	Remote Settings	User 1/ User 2/ User 3	HDMI 1
			HDMI 2
			USB C
			Test Pattern
			Brightness
			Contrast
			Sleep Timer
			CMS
			Gamma
			Projection Orientation
			Light Source Mode
	Reset		

4K Advanced Model only

### Remote Settings

This menu allows you to customize the three user buttons ( $\rho_1$ ,  $\rho_2$ ,  $\rho_3$ ) on the remote control. You can assign a menu function to each user button for quick access later.

To customize the user button:

1. Go to the Control > Remote Settings menu.
2. Select a user button (User 1, User 2, or User 3) to assign a menu function to it.
3. Press  $\langle / \rangle$  to select a desired function.
4. Once the function is selected, press  $\rightarrow$  to return to the previous menu.
5. Repeat step 1-4 to assign functions to the other user buttons.

Once User 1, User 2, and User 3 have been assigned the desired menu functions, pressing the corresponding user buttons ( $\rho_1$ ,  $\rho_2$ ,  $\rho_3$ ) on the remote control will display the menus that have been set.

### Reset

Resets all the settings in the Control menu to the factory defaults.

# USING THE PROJECTOR

## 7. Main menu: Information

Main Menu	Sub Menu	Sub Menu 2	Sub Menu 3	
Information	Regulatory			
	Serial Number			
	Source			
	Picture Mode			
	Color Info.		Color Bit Depth	
			Color Space	
			Color Gamut	
	Power Mode (Standby)		Eco	
			Active	
			Active (20 mins)	
	Light Source Hours			
	Light Source Mode			
	FW Version		DDP	
			MCU	

### Information

View the projector information as listed below:

- Regulatory
- Serial Number
- Source
- Picture Mode
- Color Bit Depth
- Color Space
- Color Gamut
- Power Mode (Standby)
- Light Source Hours
- Light Source Mode
- FW Version

# ADDITIONAL INFORMATION

## Compatible resolutions

### Input signal for HDMI PC timings

#### 4K model

Resolution	Mode	Refresh Rate (Hz)	H-Frequency (kHz)	Clock (MHz)
640 x 480	VGA_60	59.940	31.469	25.175
	VGA_72	72.809	37.861	31.500
	VGA_75	75.000	37.500	31.500
	VGA_85	85.008	43.269	36.000
	VGA_120	119.518	61.910	52.500
800 x 600	SVGA_56	56.250	35.156	36.000
	SVGA_60	60.317	37.879	40.000
	SVGA_72	72.188	48.077	50.000
	SVGA_75	75.000	46.875	49.500
	SVGA_85	85.061	53.674	56.250
	SVGA_120	119.854	77.425	83.000
1024 x 768	XGA_60	60.004	48.363	65.000
	XGA_70	70.069	56.476	75.000
	XGA_75	75.029	60.023	78.750
	XGA_120	119.804	98.958	137.750
1152 x 864	SXGA_75	75.000	67.500	108.000
	SXGA_85	84.990	77.094	121.500
1280 x 1024	SXGA_60	60.020	63.981	108.000
	SXGA_72	72.000	76.970	134.600
	SXGA_75	75.025	79.976	135.000
	SXGA_85	85.024	91.146	157.500
1280 x 960	QuadVGA_75	75.000	75.000	126.000
1400 x 1050	SXGA+_60	59.978	65.317	121.750
1600 x 1200	UXGA_60	60.000	75.000	162.000
640 x 480@60Hz	Mac G4	59.940	31.469	25.170
640 x 480@67Hz	MAC13	66.667	35.000	30.240
800 x 600@60Hz	Mac G4	60.317	37.879	40.000
1024 x 768@60Hz	Mac G4	60.004	48.363	65.000
1024 x 768@75Hz	MAC19	75.020	60.241	80.000
1152 x 870@75Hz	MAC21	75.061	68.681	100.00
1280 x 768	WXGA_60	59.870	47.776	79.500
	WXGA_75	74.893	60.289	102.250
	WXGA_85	84.837	68.633	117.500
1280 x 720	WXGA_60	60.000	45.000	74.250
1280 x 800	WXGA_60	59.810	49.702	83.500

# ADDITIONAL INFORMATION

Resolution	Mode	Refresh Rate (Hz)	H-Frequency (kHz)	Clock (MHz)
1280 x 800	WXGA_120-RB	119.909	101.563	146.25
1440 x 900	WXGA+_60	59.887	55.935	106.500
1680 x 1050	1680 x 1050_60	59.954	65.290	146.250
1920 x1080	1920 x 1080_RB	60.000	66.587	138.500
1920 x1080	1920 x 1080_EIA	60.000	67.500	148.500
1920 x1080	1920 x 1080_120	119.982	137.260	285.500
1920 x1080	1920 x 1080_240	239.76	291.309	582.617
1920 x 1200	1920 x 1200-RB	59.950	74.038	154.000
2560 x 1440	2560 x 1440_60 (RB)	60	88.8	241.5
2560 x 1440	2560 x 1440_120 (RB)	120	183.0	497.75
3840 x 2160	3840 x 2160_30	30	67.5	297
3840 x 2160	3840 x 2160_60	60	135	594

## Input signal for HDMI video timings

Resolution	Mode	Refresh Rate (Hz)	H-Frequency (kHz)	Clock (MHz)
Video (HDMI)	480i	60	15.73	27.000
	480p	60	31.47	27
	576i	50	15.63	27.000
	576p	50	31.25	27.000
	720p_60	60	45.00	74.25
	720p_50	50	37.50	74.25
	1080i_60	60	33.75	74.25
	1080i_50	50	28.13	74.25
	1080p	60	67.5	148.5
	1080p	50	56.26	148.5
	1080p	24	27.00	74.25
	1080p	23.98	26.97	74.175
	1080p	30	33.75	74.25
	2160/24P	24	54	297
	2160/25P	25	56.25	297
	2160/30P	30	67.5	297
	2160/50P	50	112.5	594
2160/60P	60	135	594	

# ADDITIONAL INFORMATION

## Image size and projection distance

### 4K Standard Model

Screen Size				Projection Distance in mm			Wide Verticle Offset (Hd)
Diagonal (inch)	Diagonal (mm)	Height (mm)	Width (mm)	Min distance (w/ max zoom)	Average	Max distance (w/ min zoom)	
60	1524	747	1328	1992	2092	2192	37
70	1778	872	1550	2324	2441	2557	44
80	2032	996	1771	2657	2789	2922	50
90	2286	1121	1992	2989	3138	3287	56
100	2540	1245	2214	3321	3487	3653	62
110	2794	1370	2435	3653	3835	4018	68
120	3048	1494	2657	3985	4184	4383	75
130	3302	1619	2878	4317	4533	4749	81
140	3556	1743	3099	4649	4881	5114	87
150	3810	1868	3321	4981	5230	5479	93

**Note:**

- *Zoom Ratio: 1.1x ± 2%*

# ADDITIONAL INFORMATION

## 4K Advanced Model

Screen Size				Projection Distance in mm			Wide Verticle Offset (Hd)
Diagonal (inch)	Diagonal (mm)	Height (mm)	Width (mm)	Min distance (w/ max zoom)	Average	Max distance (w/ min zoom)	
60	1524	747	1328	1497	1718	1939	37
70	1778	872	1550	1746	2004	2263	44
80	2032	996	1771	1996	2291	2586	50
90	2286	1121	1992	2245	2577	2909	56
100	2540	1245	2214	2495	2864	3232	62
110	2794	1370	2435	2744	3150	3555	68
120	3048	1494	2657	2994	3436	3879	75
130	3302	1619	2878	3243	3723	4202	81
140	3556	1743	3099	3493	4009	4525	87
150	3810	1868	3321	3742	4295	4848	93

**Note:**

- *Zoom Ratio: 1.3x ± 2%*

# ADDITIONAL INFORMATION

## Projector dimensions and ceiling mount installation

1. To prevent damage to your projector, please use the Optoma ceiling mount kit.
2. If you wish to use a third party ceiling mount kit, please ensure the screws used to attach a mount to the projector meet the following specifications:
  - Screw type: M4\*10mm
  - Minimum screw length: 10mm

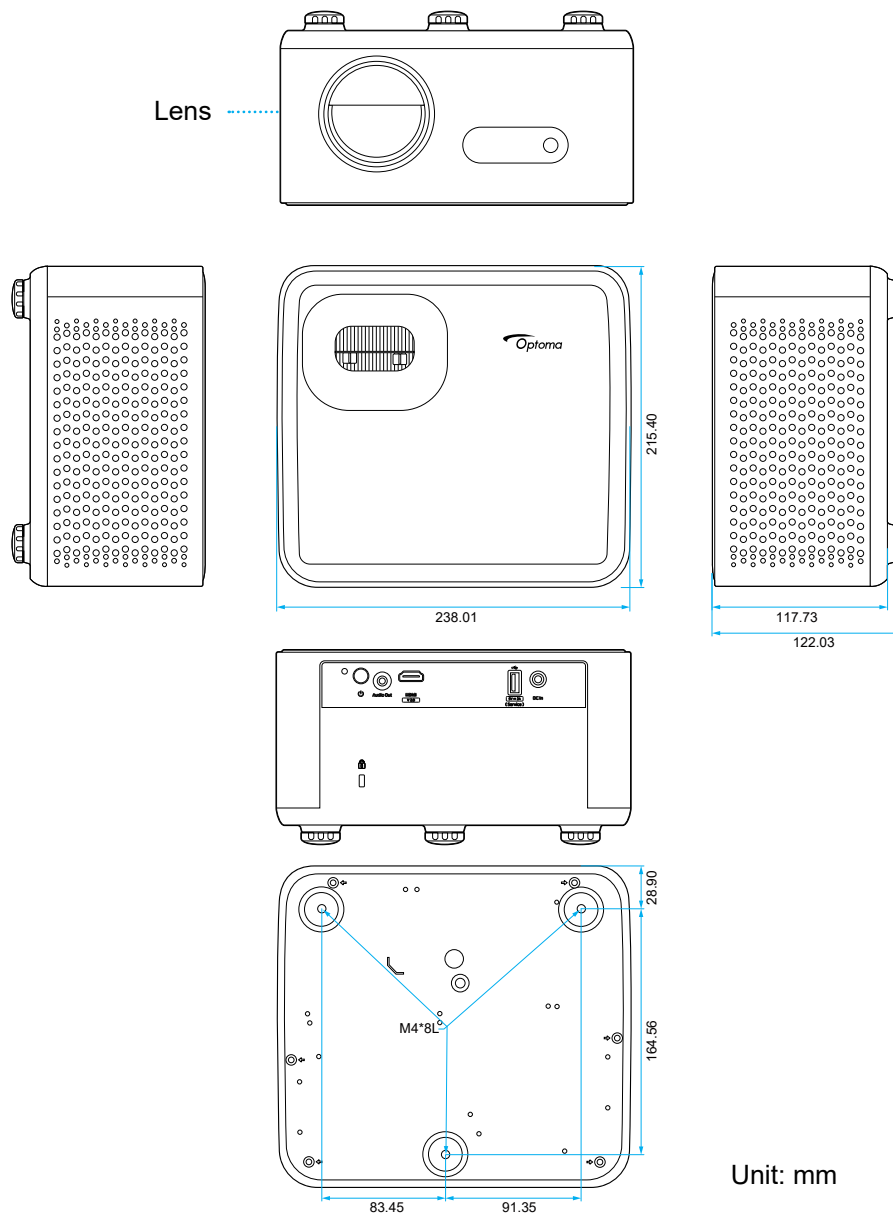

**Note:** Please note that damage resulting from incorrect installation will void the warranty.



Warning:

- If you buy a ceiling mount from another company, please be sure to use the correct screw size. Screw size will vary depending on the thickness of the mounting plate.
- Be sure to keep at least 10 cm gap between the ceiling and the bottom of the projector.
- Avoid installing the projector near a heat source.





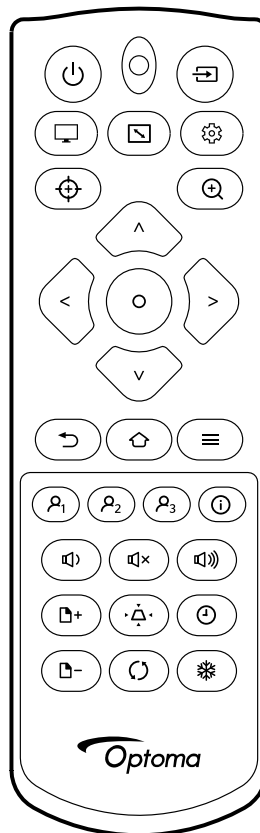











# ADDITIONAL INFORMATION

## IR remote control codes



Button	Repeat Format (F1:Not-Repeat F2: Repeat)	Custom Code		Data		Description	
		Byte 1	Byte 2	Byte 3	Byte 4		
Power On/Off		F1	32	CD	2	FD	Turns on/off the projector.
Source		F1	32	CD	C3	3C	Shows the Input Source menu.
Mode		F1	32	CD	5	FA	Shows the Picutre Mode menu.
Aspect Ratio		F1	32	CD	64	9B	Shows the Aspect Ratio menu
Settings/ Setup Menu		F1	32	CD	A8	57	Enters the Device Setup main menu.
Focus		F1	32	CD	26	D9	Shows the Focus bar menu.
Zoom		F1	32	CD	08	F7	Shows the Zoom bar menu.
Up	^	F2	32	CD	11	EE	Selects items or makes adjustments to your selection.
Left	<	F2	32	CD	10	EF	
Right	>	F2	32	CD	12	ED	
Down	v	F2	32	CD	14	EB	

# ADDITIONAL INFORMATION

Button		Repeat Format (F1: Not-Repeat F2: Repeat)	Custom Code		Data		Description
			Byte 1	Byte 2	Byte 3	Byte 4	
Enter		F1	32	CD	0F	F0	Confirms your item selection.
Return		F1	32	CD	0D	F2	Returns to the previous menu.
Home		F1	32	CD	A0	5F	<ul style="list-style-type: none"> <li>OSD on: Goes to the top level of its category.</li> <li>OSD off: No function.</li> </ul>
Menu		F1	32	CD	0E	F1	Turns on/off the onscreen display menus
User1		F1	32	CD	36	C9	Recalls user defined settings.
User2		F1	32	CD	65	9A	
User3		F1	32	CD	66	99	
Information		F1	32	CD	25	DA	Shows the information menu.
Vol-		F2	32	CD	8F	70	Decreases the projector volume.
Mute		F1	32	CD	52	AD	Toggles the projector audio between on and off.
Vol+		F2	32	CD	8C	73	Increases the projector volume.
Page Up		F2	32	CD	C1	3E	Goes to the previous or next OSD menu page.
Page Down		F2	32	CD	C2	3D	
Keystone Correction		F1	32	CD	7	F8	Shows the Geometric Correction menu.
Sleep Timer		F1	32	CD	63	9C	Shows the Sleep Timer menu.
Resync		F1	32	CD	C4	3B	Resynchronizes the input source.
Freeze		F1	32	CD	6	F9	Freezes the image.

# ADDITIONAL INFORMATION

## Troubleshooting

If you experience a problem with your projector, please refer to the following information. If the problem persists, please contact your local reseller or service center.

### Image problems

- ❓ *No image appears on-screen*
  - Ensure all the cables and power connections are correctly and securely connected as described in the "Installation" section.
  - Ensure that the pins of the connectors are not crooked or broken.
  - Ensure that the "Mute" feature is not turned on.
  
- ❓ *Image is out of focus*
  - Turn the focus ring clockwise or counterclockwise until the image becomes sharp and clear. (Please see page 17).
  - Make sure the projection screen is between the required distance from the projector. (Please refer to pages 44~45).
  
- ❓ *The image is stretched when displaying a 16:9 DVD title*
  - When you play an anamorphic DVD or a 16:9 DVD, the projector will display the best image in 16:9 format.
  - If you play a 4:3 format DVD title, please change the format as 4:3 in the projector's OSD.
  - Please set up the display format as 16:9 (wide) aspect ratio on your DVD player.
  
- ❓ *Image is too small or too large*
  - Turn the zoom lever clockwise or counterclockwise to increase or decrease the projected image size. (Please see page 17).
  - Move the projector closer to or farther from the screen.
  - Press  (Menu) on the remote control, go to "Display > Aspect Ratio". Try the different settings.
  
- ❓ *Image has slanted sides*
  - If possible, reposition the projector so that it is centered on the screen and below the bottom of the screen.
  
- ❓ *Image is reversed*
  - Select "Display > Projection Orientation" from the OSD and adjust the projection direction.

# ADDITIONAL INFORMATION

## Other problems



*The projector stops responding to all controls*

- If possible, turn off the projector, then unplug the power cord and wait at least 20 seconds before reconnecting power.

## Remote control problems



*If the remote control does not work*

- Check the operating angle of the remote control is pointed within  $\pm 30^\circ$  to the IR receiver on the projector.
- Make sure there are not any obstructions between the remote control and the projector. Move to within 8 m (26 ft) of the projector.
- Make sure batteries are inserted correctly.
- Replace batteries if they are exhausted.

# ADDITIONAL INFORMATION

## Warning indicator

When the warning indicators (see below) light up or flash, the projector will automatically shut down:

- Thermal error: The LED indicator lights red and flashes blue.
- Fan error: The LED indicator flashes red and lights blue.
- Light error: The LED indicator flashes blue.

Unplug the power cord from the projector, wait for 30 seconds and try again. If the warning indicator lights up or flashes, please contact your nearest service center for assistance.

## LED indicator messages

Message	Power LED	
	(Red)	(Blue)
Standby state (Input power cord)	Steady light	
Power on		Steady light
Power off (Cooling)	Steady light	
Firmware download	Flashing	
Thermal error	Steady light	Flashing
Fan error	Flashing	Steady light
Light error		Flashing

- Power off:



- Temperature warning:

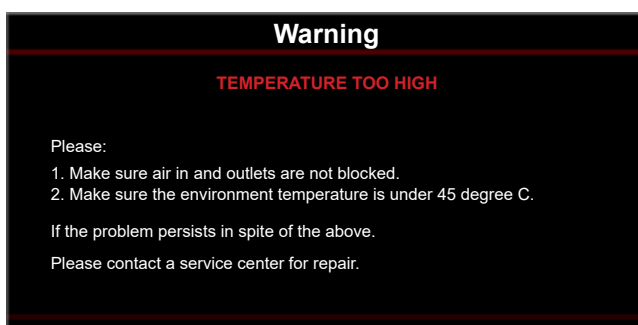

- Fan warning:

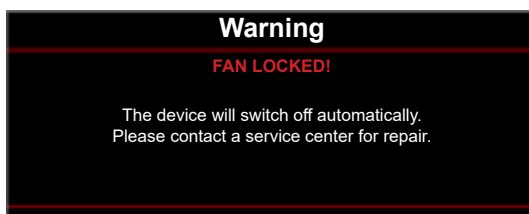

# ADDITIONAL INFORMATION

## Specifications

Item	Description
Resolution	3840 x 2160
Lens	Throw ratio <ul style="list-style-type: none"> <li>• 4K Standard Model: 1.50 to 1.65</li> <li>• 4K Advanced Model: 1.127 to 1.46</li> </ul>
	F-stop <ul style="list-style-type: none"> <li>• 4K Standard Model: 2.0 to 2.05</li> <li>• 4K Advanced Model: 1.94 to 2.12</li> </ul>
	Focal length <ul style="list-style-type: none"> <li>• 4K Standard Model: 15.843 to 17.445 mm</li> <li>• 4K Advanced Model: 11.9 to 15.5 mm</li> </ul>
	Zoom range <ul style="list-style-type: none"> <li>• 4K Standard Model: 1.1x ± 2%</li> <li>• 4K Advanced Model: 1.3x ± 2%</li> </ul>
Offset	105%, tolerance ± 3%
Image size	<ul style="list-style-type: none"> <li>• 4K Standard Model: 60" to 150"</li> <li>• 4K Advanced Model: 60" to 150"</li> </ul>
Projection distance	<ul style="list-style-type: none"> <li>• 4K Standard Model: 1.99 m to 4.98 m</li> <li>• 4K Advanced Model: 1.50 m to 3.74 m</li> </ul>
I/Os	<ul style="list-style-type: none"> <li>• 4K Standard Model:               <ul style="list-style-type: none"> <li>• HDMI 2.0 x 1</li> <li>• Audio Out 3.5 mm</li> <li>• USB Type-A x 1</li> <li>• DC Jack</li> </ul> </li> <li>• 4K Advanced Model:               <ul style="list-style-type: none"> <li>• HDMI 2.0 x 2</li> <li>• Audio Out 3.5 mm</li> <li>• USB Type-A x 1</li> <li>• USB Type-C x 1</li> <li>• DC Jack</li> </ul> </li> </ul>
Colour	1.07 Billion Colors
Scan rate	<ul style="list-style-type: none"> <li>• 4K Standard Model               <ul style="list-style-type: none"> <li>• Horizontal scan rate: 15KHz to 255KHz</li> <li>• Vertical scan rate: 23Hz to 240Hz</li> </ul> </li> <li>• 4K Advanced Model               <ul style="list-style-type: none"> <li>• Horizontal scan rate: 15KHz to 255KHz</li> <li>• Vertical scan rate: 23Hz to 240Hz</li> </ul> </li> </ul>
Speaker	<ul style="list-style-type: none"> <li>• 4K Standard Model: 5W x 1</li> <li>• 4K Advanced Model: 5W x 2</li> </ul>

# ADDITIONAL INFORMATION

Item	Description
Power consumption	<ul style="list-style-type: none"> <li>Standby mode: &lt; 0.5W</li> <li>4K Standard Model               <ul style="list-style-type: none"> <li>Bright mode: 87W range 15% @110VAC (typ.); 85W range 15% @ 220VAC (typ.)</li> <li>Eco mode: 53W range 15% @110VAC (typ.); 52W range 15% @220VAC (typ.)</li> </ul> </li> <li>4K Advanced Model               <ul style="list-style-type: none"> <li>Bright mode: 135W range 15% @110VAC (typ.); 133W range 15% @ 220VAC (typ.)</li> <li>Eco mode: 74W range 15% @110VAC (typ.); 73W range 15% @220VAC (typ.)</li> </ul> </li> </ul>
Input current	<ul style="list-style-type: none"> <li>4K Standard Model               <ul style="list-style-type: none"> <li>DC 20V, 5A</li> </ul> </li> <li>4K Advanced Model               <ul style="list-style-type: none"> <li>DC 20V, 9A</li> </ul> </li> </ul>
Installation orientations	Front, Rear, Ceiling, Rear-top
Dimensions (W x D x H)	<ul style="list-style-type: none"> <li>Without feet: 238 x 215 x 117.7 mm</li> <li>With feet: 238 x 215 x 130 mm</li> </ul>
Weight	<ul style="list-style-type: none"> <li>4K Standard Model: 2.3 kg</li> <li>4K Advanced Model: 2.7 kg</li> </ul>
Environmental	Operating in 0~40°C, 90% humidity (max., non-condensing)



**Note:** All specifications are subject to change without notice.

## Optoma global offices

For service or support, please contact your local office.



### USA

Optoma Technology, Inc.  
47697 Westinghouse Drive.  
Fremont, Ca 94539

 888-289-6786  
 510-897-8601  
 [services@optoma.com](mailto:services@optoma.com)



### Canada

Optoma Technology, Inc.  
47697 Westinghouse Drive.  
Fremont, Ca 94539

 888-289-6786  
 510-897-8601  
 [services@optoma.com](mailto:services@optoma.com)



### Latin America

Optoma Technology, Inc.  
47697 Westinghouse Drive.  
Fremont, Ca 94539

 888-289-6786  
 510-897-8601  
 [services@optoma.com](mailto:services@optoma.com)



### Europe

Unit 1, Network 41, Bourne End Mills  
Hemel Hempstead, Herts,  
HP1 2UJ, United Kingdom  
[www.optoma.eu](http://www.optoma.eu)  
Service Tel : +44 (0)1923 691865

 +44 (0) 1923 691 800  
 +44 (0) 1923 691 888  
 [service@tsc-europe.com](mailto:service@tsc-europe.com)



### Benelux BV

Randstad 22-123  
1316 BW Almere  
The Netherlands  
[www.optoma.nl](http://www.optoma.nl)

 +31 (0) 36 820 0252  
 +31 (0) 36 548 9052



### France

Bâtiment E  
81-83 avenue Edouard Vaillant  
92100 Boulogne Billancourt, France

 +33 1 41 46 12 20  
 +33 1 41 46 94 35  
 [savoptoma@optoma.fr](mailto:savoptoma@optoma.fr)



### Spain

C/ José Hierro,36 Of. 1C  
28522 Rivas VaciaMadrid,  
Spain

 +34 91 499 06 06  
 +34 91 670 08 32



### Deutschland

Am Nordpark 3  
41069 Mönchengladbach  
Germany

 +49 (0) 2161 68643 0  
 +49 (0) 2161 68643 99  
 [info@optoma.de](mailto:info@optoma.de)

### Scandinavia

Lerpeveien 25  
3040 Drammen  
Norway

 +47 32 98 89 90  
 +47 32 98 89 99  
 [info@optoma.no](mailto:info@optoma.no)

PO.BOX 9515  
3038 Drammen  
Norway

### Korea

<https://www.optoma.com/kr/>

### Japan



<https://www.optoma.com/jp/>

### Taiwan

<https://www.optoma.com/tw/>

### China

Room 2001, 20F, Building 4,  
No.1398 Kaixuan Road,  
Changning District  
Shanghai, 200052, China

 +86-21-62947376  
 +86-21-62947375  
[www.optoma.com.cn](http://www.optoma.com.cn)

### Australia

<https://www.optoma.com/au/>

