

PEM31SF/EF/BM/FM

GE Profile™ Series 1.1 Cu. Ft. Countertop Microwave Oven

DIMENSIONS AND INSTALLATION INFORMATION (IN INCHES)

EXTERIOR DIMENSIONS* (IN INCHES)	
W x H x D	24 x 11-3/4 x 12-7/8

*Height includes feet. Depth does not include handle and excludes receptacle plug, + 1/2"-3/4".

OPTIONAL ACCESSORY TRIM KITS FOR GE MICROWAVE OVENS: For a custom built-in appearance, these kits allow built-in installation of the countertop microwave oven into a wall or cabinet alone, and is U. L. approved for installation over a GE single electric wall oven. These kits should not be installed over a gas wall oven.

ACCESSORY TRIM KIT	"Z"	MAX HEIGHT	TRIM KIT
27" Deluxe	26-7/8"	16-1/2"	JX827SFSS
30" Deluxe	29-7/8"	16-1/2"	JX830SFSS

INSTALLATION INFORMATION: This information is not intended to be used for installing unit described. Before installing, consult installation instructions packed with product for current dimensional data.

NOTE: UNDERCABINET INSTALLATION

Install countertop microwave ovens in just a few easy steps with the mounting template, which provides all the necessary measurements. Installation may vary depending on cabinets. These microwave ovens can be installed on practically any wood or metal cabinets.

NOTE: 120V, 60-cycle, grounded power receptacle location optional on back within cabinet opening.

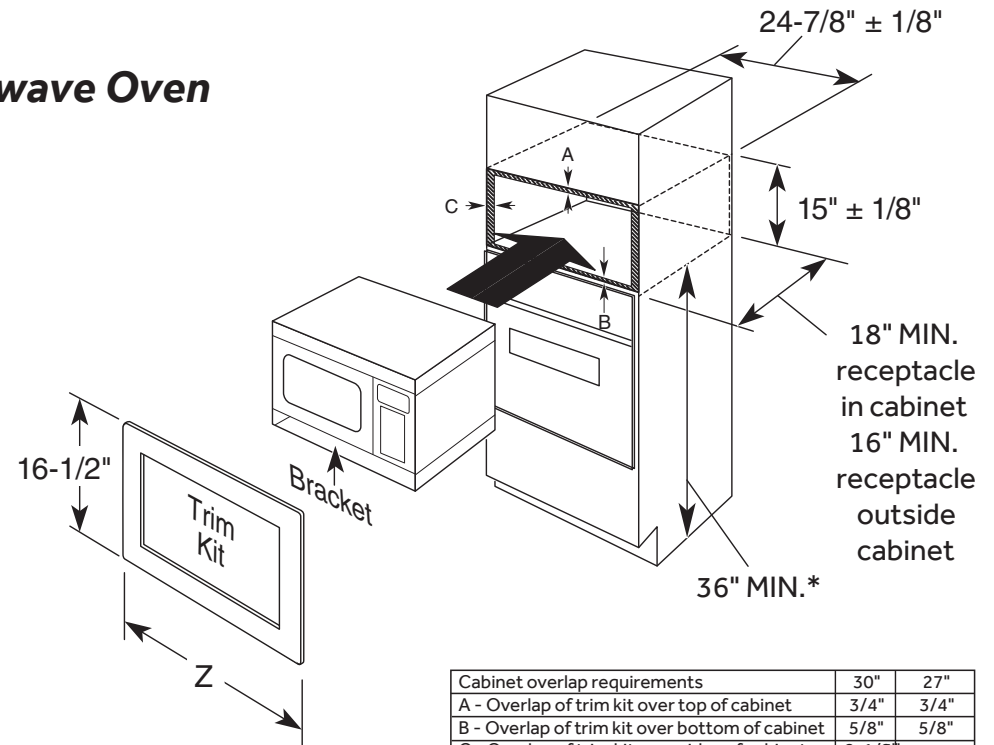

*For ADA compliance, the microwave must be installed no higher than 37-7/8".

Note:
Allow an additional inch of clearance beyond trim frame on all sides

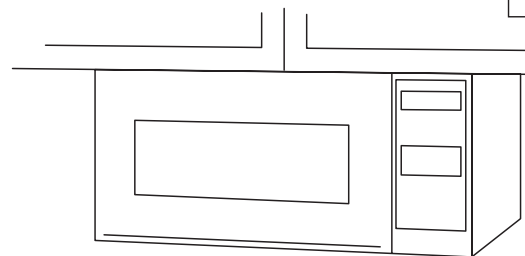

Not to be used over a thermal oven.
Undercabinet mounting kit Pub. No. JXA019K for Spacemaker II microwave oven models available at additional cost.



PEM31SF/EF/BM/FM

GE Profile™ Series 1.1 Cu. Ft. Countertop Microwave Oven

FEATURES AND BENEFITS

1.1 cu. ft. capacity – 800 Watts (IEC-705 test procedure)

Sensor cooking controls – Automatically adjusts time and power

Optional built-in trim kit – Custom appearance and built-in convenience

Optional hanging kit – Frees up counter space

Weight and time defrost – Simply enter the weight of the food, and the oven automatically sets the optimal defrosting time and power level or set your desired time or defrosting

Turntable on/off – Controls turntable operation

Control lockout – Helps prevent accidental activation

Add 30 seconds – Add 30 seconds of microwave cooking time

Kitchen timer – Minute timer helps keep you on track

Timer on/off – Minute timer helps keep you on track

Model PEM31SFSS – Stainless steel

Model PEM31EFES – Slate

Model PEM31BMTS – Black stainless

Model PEM31FMDS –Black slate

