

PE365INDXV

36" INDUCTION COOKTOP XV
BLACK GLASS



Experience instantaneous touch-through glass precision control

Select individual induction heating zones up to 3700 Watt performance reducing time-to-boil by up to 50%

Benefit from maximized cookware size accommodation
1 full surface bridge function setting with up to 5000 Watts with booster

Have full control over the cooking process with timer functions for each heating zone

Enjoy the utmost in easy cleaning of the tempered ceramic glass surface

PRODUCT FEATURES

COOKTOP

Maintop	5 induction zones
Heating zone power	Front Left Ø 7" 2000W (2500 W booster) Back Left Ø 7" 2000W (2500 W booster) Center Ø 11" 2700W (3700 W booster) Front Right Ø 7" 1400W (1800 W booster) Back Right Ø 7" 2700W (3200 W booster)
Controls	Touch-through-glass slider
Bridge function	Yes
Timer	Timed cooking function option for each induction zone
Power levels	9 + Booster
Stop & Recall function	yes
Auto-Stop	yes
Residual Heat indicator	yes

TECHNICAL SPECIFICATIONS

Electrical supply	208 - 240 V 60 HZ - 10400 W 45 Amp dedicated circuit
Power connection	Hardwired with 40 3/16" power cord
Certification	ETL
Packaging dimensions and weight	W 38.58" H 23.82" D 6.69" 50.7 lbs

PE365INDXV

36" INDUCTION COOKTOP XV
BLACK GLASS



PRODUCT AND CUTOUT DIMENSIONS

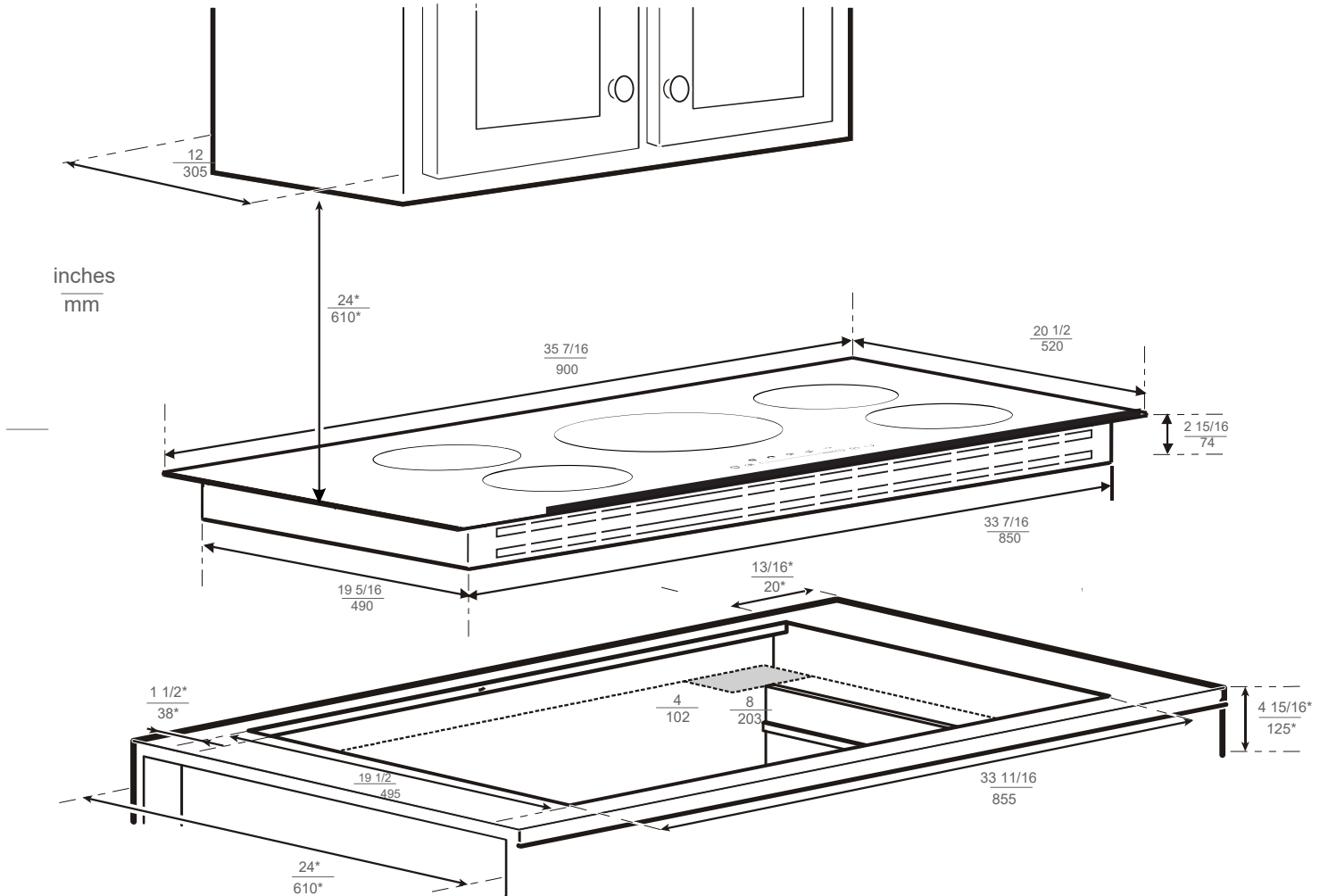

* minimum dimension to be granted

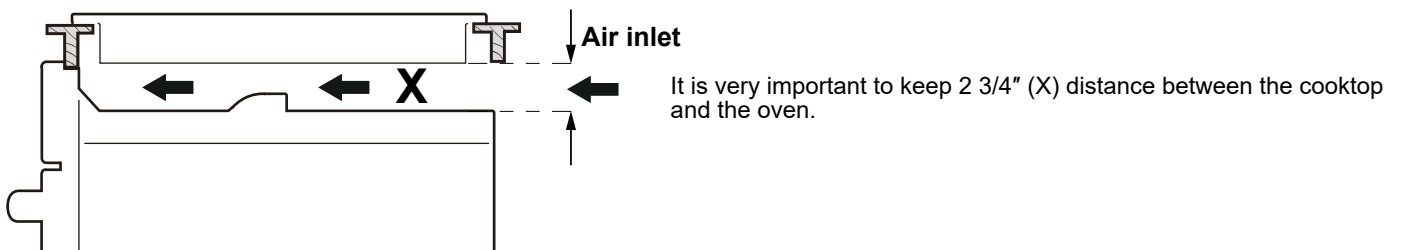

For complete installation details refer to the installation manual at us.bertazzoni.com or ca.bertazzoni.com

Disclaimer: while every effort has been made to ensure the accuracy of the information contained in this document, Fratelli Bertazzoni reserves the right to change it at any time without notice. For detailed installation instructions, consult the installation manual. Fratelli Bertazzoni, Bertazzoni and the winged wheel brand icon are registered trademarks of Bertazzoni Spa.