

# PB900YV

## GE Profile™ 30" Smart Free-Standing Electric Convection Fingerprint Resistant Range with No Preheat Air Fry

### DIMENSIONS AND INSTALLATION INFORMATION (IN INCHES)

**RECEPTACLE LOCATIONS:** Locally approved flexible service cord or conduit must be used because terminals are not accessible after range installation. See shaded area in drawing for location of electrical outlet box. Recommended outlet locations allow range to be installed directly against wall.

**NOTE:** This appliance has been approved for 0" spacing to adjacent surfaces above the cooktop. However, a 6" minimum spacing to surfaces less than 15" above the cooktop and adjacent cabinet is recommended to reduce exposure to steam, grease splatter and heat.

**INSTALLATION INFORMATION:** Before installing, consult installation instructions for current dimensional data and additional requirements.

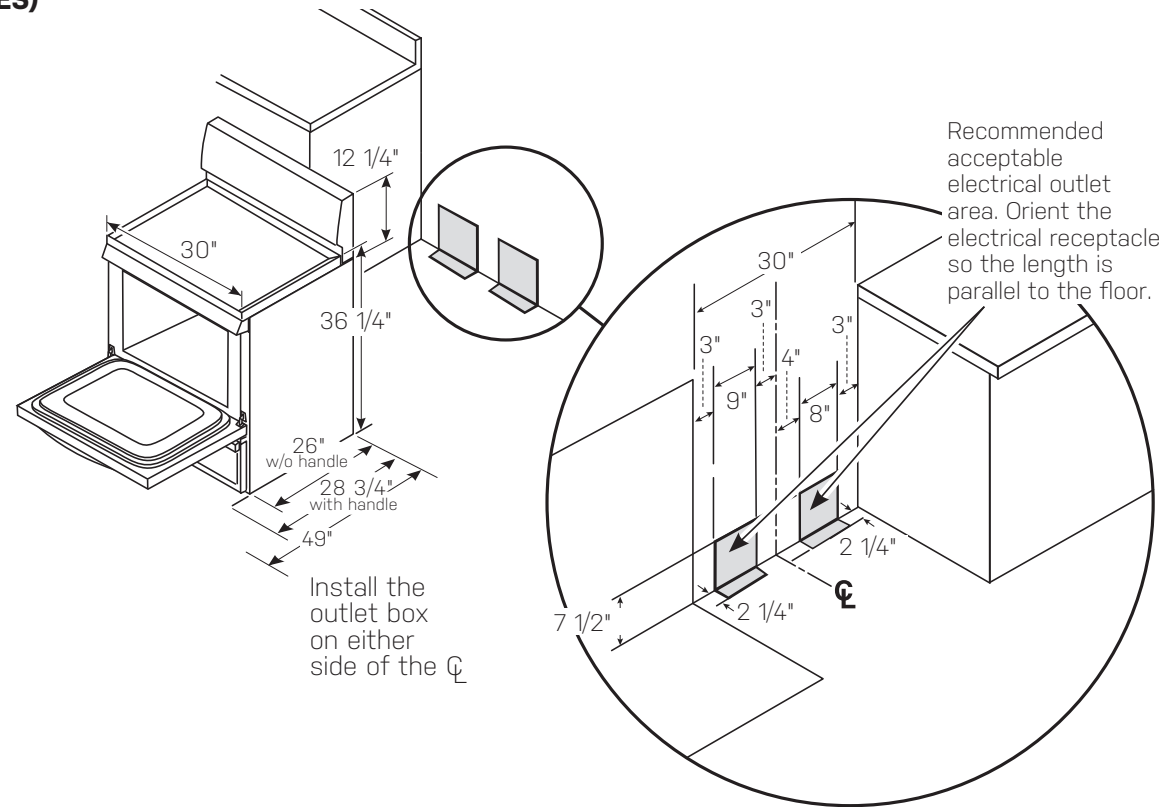

KW RATING	
240V	13.3
208V	10.2
BREAKER SIZE	
240V	40 Amps <sup>†</sup>
208V	40 Amps <sup>†</sup>

<sup>†</sup>**NOTE:** Check local codes for required breaker size.



For answers to your Monogram, Café™, GE Profile™ or GE Appliances product questions, visit our website at [geappliances.com](http://geappliances.com) or call GE Answer Center® Service, 800.626.2000.



Specification Revised 4/24

# PB900YV

## GE Profile™ 30" Smart Free-Standing Electric Convection Fingerprint Resistant Range with No Preheat Air Fry

### FEATURES AND BENEFITS

**Extra-Large Capacity** – 6.2 cu. ft. oven cavity allows you to cook more at once.

**No Preheat Air Fry** – With this air fryer right in the oven, you can cook healthier, crispier versions of your favorite foods. There's no preheat required and it shortens the cook time because every minute counts.

**Built-in WiFi** – This smart oven features built-in WiFi so you can control oven functions with the SmartHQ™ app on your smart device.

**Fingerprint Resistant Stainless** – A stainless finish that makes it easy to keep your appliances free of smudges and prints.

**Two Power Boil™ Elements** – A power boil produces concentrated heat for rapid boiling in a flexible burner size so you spend less time waiting and more time cooking.

**Two Dual Elements** – 12"/9" and 9"/6". A dual burner cooktop lets you choose between element size for a more convenient cooking experience.

**True Convection** – This oven features True Convection, an advanced convection system that uses a third heating element and fan for the highest level of heat and air circulation.

**Fast Preheat** – Preheat the oven quickly and cut down on preheat time with a speedy preheat feature.

**Fifth Element Warming Zone** – A convenient low-heat warming zone provides even temperature control for foods on the cooktop.

**Self-Clean with Steam Clean** – This self-cleaning oven uses optional steam cleaning for light soils to clean the oven cavity with less heat and odor.

**Hidden Baking Element** – This oven features a hidden baking element that gets rid of hard-to-reach areas and makes cleanup easier.

**Black Gloss Oven Interior** – A clean and sleek interior that is attractive and easy to maintain.

**Model PB900YVFS** – Fingerprint Resistant Stainless Steel

