

FISHER & PAYKEL

PRELIMINARY SPECIFICATION GUIDE

OVEN, 24"



OVERVIEW

Designed to fit seamlessly into any kitchen with Contemporary styling, this 24" oven features a generous 3 cu ft total capacity. Achieve perfect results with 16 oven functions, plus a Wireless Temperature Sensor for monitoring cooking in real time. Beautiful to use, the large 5" touchscreen interface features simple and intuitive guided cooking, while Pyrolytic self-cleaning breaks down grime and grease, to keep the oven pristine for the next use.

MODELS

Oven, 24", 16 Function

3 cu ft, Self-cleaning, Stainless steel, Touchscreen, Dial
OB24SDPTDX2

SERIES & STYLE

Series 9
Contemporary

ACCESSORIES

- 1 Roasting dish
- 2 Broil grid
- 3 Broil rack

FEATURES

- 1 Contemporary style, designed to fit flush with cabinetry
- 2 Generous 3 cu ft total capacity with six shelf positions
- 3 Intuitive, large 5" touchscreen display with illuminated dial
- 4 16 oven functions including Air Fry, Fan Bake, and Roast
- 5 Pyrolytic self-cleaning function breaks down food residue for an easy clean
- 6 Wireless Temperature Sensor precisely monitors cooking in real time*
- 7 Guided touchscreen cooking makes it simple to cook by food, function or recipe
- 8 Moisture control and even heat distribution thanks to ActiveVent and AeroTech™ technology
- 9 Automatic rapid pre-heat function for added convenience
- 10 Soft open and close door
- 11 Wi-Fi/Connected capability through the SmartHQ™ app*

*Selected markets and models

- 4 Step down wire shelf
- 5 Full extension wire shelves
- 6 Wireless Temperature Sensor*

*Selected markets and models

FISHER & PAYKEL

PRELIMINARY SPECIFICATION GUIDE

OVEN, 24"

SPECIFICATIONS

Model No.	OB24SDPTDX2
Dimensions	H 23 9/16" (598mm) x W 23 7/16" (596mm) x D 22 1/4" (565mm)
Total capacity	3 cu ft (85L)
Weight	70 lbs (32kg) unpackaged 97 lbs (44kg) packaged
Electrical	
Supply	208-240V, 60Hz
Service	16.6 - 19.4 A circuit

PRODUCT DIMENSIONS

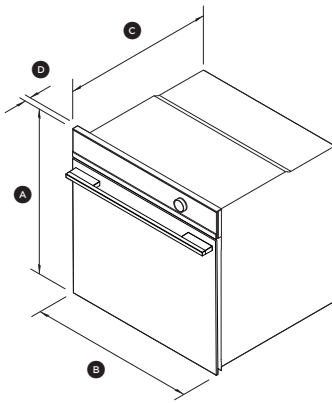

ISO VIEW

		in	mm
(A)	Overall height	23 9/16	598
(B)	Overall width	23 7/16	596
(C)	Depth of chassis	21 7/16	545
(D)	Depth from front of chassis to front of oven door (excl.dial & handle)	13/16	20
	Depth of oven door when fully open (measured from front of control panel)	18 1/8	460

CAVITY DIMENSIONS

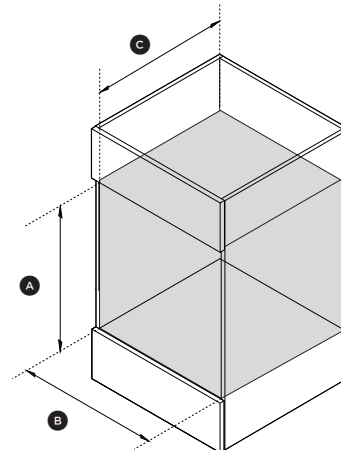

ISO VIEW

		in	mm
(A)	Minimum inside height of cavity	22 7/8	580
(B)	Minimum inside width of cavity	22 1/16	560
(C)	Minimum inside depth of cavity	21 11/16	550