

# Electric Cooktop

---

User manual

NZ36K7880U\*

---



**SAMSUNG**

# Regulatory Notice

---

## 1. FCC Notice

### CAUTION

**FCC CAUTION:** Any changes or modifications not expressly approved by the party responsible for compliance could void the user's authority to operate the equipment.

This device complies with Part 15 of FCC Rules. Operation is Subject to following two conditions:

- 1) This device may not cause harmful interference, and
- 2) This device must accept any interference received including interference that cause undesired operation.

For products sold in the US and Canadian markets, only channels 1~11 are available. You cannot select other channels.

### **FCC STATEMENT:**

This equipment has been tested and found to comply within the limits for a Class B digital device, pursuant to part 15 of the FCC Rules. These limits are designed to provide reasonable protection against harmful interference in a residential installation.

This equipment generates, uses, and can radiate radio frequency energy and, if not installed and used in accordance with the instructions, may cause harmful interference to radio communications. However, there is no guarantee that interference will not occur in a particular installation. If this equipment does

cause harmful interference to radio or television reception, which can be determined by turning the equipment off and on, the user is encouraged to try to correct the interference by one or more of the following measures:

- Reorienting or relocating the receiving antenna
- Increasing the separation between the equipment and receiver
- Connecting the equipment to an outlet that is on a different circuit than the radio or TV.
- Consulting the dealer or an experienced radio/TV technician for help.

### **FCC RADIATION EXPOSURE STATEMENT:**

This equipment complies with FCC radiation exposure limits set forth for an uncontrolled environment. This equipment should be installed and operated so there is at least 8 inches (20 cm) between the radiator and your body. This device and its antenna(s) must not be co-located or operated in conjunction with any other antenna or transmitter.

## Regulatory Notice

---

### 2. IC Notice

The term "IC" before the radio certification number only signifies that Industry Canada technical specifications were met. Operation is subject to the following two conditions: (1) this device may not cause interference, and (2) this device must accept any interference, including interference that may cause undesired operation of the device.

This Class B digital apparatus complies with Canadian ICES-003. For products sold in the US and Canadian markets, only channels 1~11 are available. You cannot select other channels.

#### **IC RADIATION EXPOSURE STATEMENT:**

This equipment complies with IC RSS-102 radiation exposure limits set forth for an uncontrolled environment. This equipment should be installed and operated so there is at least 8 inches (20 cm) between the radiator and your body. This device and its antenna(s) must not be co-located or operated in conjunction with any other antenna or transmitter.

### General safety instructions

This unit has been tested and found to comply with the limits for a class B digital device, pursuant to Part 18 of the FCC rules. These limits are designed to provide reasonable protection against harmful interference in a residential installation. This unit generates, uses and can radiate radio frequency energy and, if not installed and used in accordance with the instructions, may cause harmful interference to radio communications.

However, there is no guarantee that interference will not occur in a particular installation. If this unit does cause harmful interference to radio or television reception, which can be determined by turning the unit off and on, the user is encouraged to try to correct the interference by one or more of the following measures:

- Reorienting or relocating the receiving antennae.
- Increasing the distance between the unit and receiver.
- Connecting the equipment to an outlet that is on a different circuit than the radio or TV.

# Contents

<b>Important safety instructions</b>	<b>5</b>		
What you need to know about safety instructions	5	Power boost control	22
California Proposition 65 Warning	6	Power management	22
For your safety	6	Pause	22
Surface cooking units	7	Flex zone	23
Electrical safety	9	Sound on/off	24
Child safety	9	Virtual flame on/off	25
Ventilating hood	10	Before using the cooktop	25
Glass/ceramic cooking surfaces	10	Cookware for induction cooking zones	26
Critical installation warnings	10	Using the correct size cookware	27
Critical usage warning	11	Pot and pan sizes	27
Usage cautions	13	Operating noises	27
Critical cleaning warnings	15	Using suitable induction cookware	28
		Temperature detection	28
<b>Before you start</b>	<b>15</b>	Protecting the cooktop surface	29
About induction cooktop cooking	15	Using the smart connect feature	29
Location of the induction cooktop elements and controls	16	Using the hood control feature	30
Virtual flame technology	17	<b>Maintaining your appliance</b>	<b>30</b>
Magnetic Knob	18	Care and cleaning of the glass cooktop	30
Residual heat indicator	18	<b>Troubleshooting</b>	<b>32</b>
Cooking areas	18	Troubleshooting	32
Initial cleaning	19	Information codes	34
Digital display	19	<b>Warranty (U.S.A)</b>	<b>34</b>
Safety shutoff	19	<b>Warranty (CANADA)</b>	<b>36</b>
		<b>Appendix</b>	<b>37</b>
<b>Operation</b>	<b>19</b>	Open source announcement	37
Switching the appliance on	19	Model name & serial number	38
Selecting a cooking zone and power setting	19		
Switching the appliance off	20		
Using the child lock	21		
Timer	21		
<b>4 English</b>			



## Important safety instructions

Read and follow all instructions before using your cooktop to prevent the risk of fire, electric shock, personal injury, or damage when using the cooktop. This guide does not cover all possible conditions that may occur. Always contact your service agent or the manufacturer about problems that you do not understand.

## WHAT YOU NEED TO KNOW ABOUT SAFETY INSTRUCTIONS

Warnings and Important safety instructions in this manual do not cover all possible conditions and situations that may occur. It is your responsibility to use common sense, caution, and care when installing, maintaining, and operating your cooktop.

### Important safety symbols and precautions

What the icons and signs in this user manual mean:

#### WARNING

Hazards or unsafe practices that may result in **severe personal injury or death**.









#### CAUTION

Hazards or unsafe practices that may result in **minor personal injury or property damage**.

**SAVE THESE INSTRUCTIONS**

#### CAUTION

To reduce the risk of fire, explosion, electric shock, or personal injury when using your cooktop, follow these basic safety precautions.

-  Do NOT attempt.
-  Do NOT disassemble.
-  Do NOT touch.
-  Follow directions explicitly.
-  Unplug the power plug from the wall socket.
-  Make sure the machine is grounded to prevent electric shock.
-  Call a Samsung service center for help.
-  Note

These warning signs are here to prevent injury to you and others. Please follow them explicitly.

After reading this section, keep it in a safe place for future reference.

**SAVE THESE INSTRUCTIONS**

## Important safety instructions

---

### CALIFORNIA PROPOSITION 65 WARNING

---

#### WARNING



Cancer and Reproductive Harm - [www.P65Warnings.ca.gov](http://www.P65Warnings.ca.gov).

### FOR YOUR SAFETY



---

When using electrical appliances, you should follow basic safety precautions, including the following:

#### CAUTION

- Use this appliance only for its intended purpose as described in this Owner's Manual.
- Potentially hot surfaces include cooktop, the cooktop facing, and areas near the cooktop.
-  User servicing - Do not repair or replace any part of the appliance unless specifically recommended in this manual. All other servicing should be referred to a qualified technician.
-  Always disconnect the power to the appliance before servicing by removing the fuse or switching off the circuit breaker.

**SAVE THESE INSTRUCTIONS**

-  • **Do not store items of interest to children in cabinets above the cooktop surface.** Children climbing on the cooktop to reach items could be seriously injured.
- **Do not leave children alone.** Never leave children alone or unattended in an area where this appliance is in use. They should never be allowed to sit or stand on any part of the appliance.
- **Never use your appliance for warming or heating the room.**
- **Do not use water on grease fires.** Turn off the cooktop to avoid spreading the flames. Smother the fire or flames or use a dry chemical, baking soda, or foam-type extinguisher.
-  • **Storage in or on the appliance.** Do not store flammable materials near the surface units. Be sure all packing materials are removed from the appliance before operating it. Keep plastics, clothes, and paper away from parts of the appliance that may become hot.
- **Wear proper apparel.** Never wear loose-fitting or hanging garments while using the appliance.
- **Use only dry potholders.** Placing moist or damp potholders on hot surfaces may result in burns from steam. Do not let the potholder touch hot heating elements. Do not use a towel or other bulky cloth.

**SAVE THESE INSTRUCTIONS**

- ★ • Teach children not to play with the controls or any other part of the cooktop.
- ⚡ • Be sure your appliance is properly installed and grounded by a qualified technician.
- ☒ • Avoid scratching or striking the cooktop. Doing so may lead to glass breakage. Do not cook on a cooktop with broken glass. Shock, fire, or cuts may occur.
- ★ • For your safety, do not use high-pressure water cleaners or steam jet cleaners to clean any part of the cooktop.
- If the power cord is damaged, it must be replaced by the manufacturer, its service agent, or similarly qualified persons to avoid creating a hazard.
- The appliance is not intended for use by persons (including children) with reduced physical, sensory or mental capabilities, or lack of experience and knowledge, unless they have been given supervision or instruction concerning use of the appliance by a person responsible for their safety.
- Do not lean on the cooktop as you may turn the control knobs inadvertently.

**SAVE THESE INSTRUCTIONS**

## SURFACE COOKING UNITS

- ☒ • **Never leave surface units unattended at high heat settings.** Boilovers cause smoking and greasy spillovers that may ignite.
- Protective Liners - Do not use aluminum foil to line surface unit drip bowls or oven bottoms, except as suggested in the manual. Improper installation of these liners may result in a risk of electric shock or fire.
- **Do not lift the cooktop.** Lifting the cooktop can damage the cooktop and cause the cooktop to malfunction.
- ☒ • Never use the glass cooktop surface as a cutting board.
- ★ • **Use care when touching the cooktop.** The glass surface of the cooktop will retain heat after the controls have been turned off.
- **Use proper pan sizes.** This appliance is equipped with surface units of different size. Select pots and pans that have flat bottoms large enough to cover the surface area of the heating element. Using undersized cookware will expose a portion of the heating element to direct contact and may result in the ignition of clothing. Matching the size of the pot or pan to the burner will also improve efficiency.

**SAVE THESE INSTRUCTIONS**

## Important safety instructions

---

- ★ • **Cookware Handles Should Be Turned Inward and Not Extend Over Adjacent Surface Units** - To reduce the risk of burns, ignition of flammable materials, or spillage due to unintentional contact with cookware, position cookware handles so that they are turned inward and do not extend over adjacent surface units.
- **Glazed cookware.** Only certain types of glass, glass/ceramic, ceramic, earthenware, or other glazed cookware can be used for rangetop service without breaking due to sudden changes in temperature.
- Always turn the surface units off before removing cookware.
- Keep an eye on foods being fried at high or medium high heat settings.
- ☐ • To avoid oil spillover and fire, use a minimum amount of oil when shallow pan-frying and avoid cooking frozen foods that have excessive amounts of ice.
- **Do not operate the cooktop without cookware.** If the cooktop operates without cookware, the control knobs will become hot.
- ★ • Do not move the container and bowl in a horizontal position on cooktop surface.

**SAVE THESE INSTRUCTIONS**

- ★ • **Be careful when placing spoons or other stirring utensils on the glass cooktop surface when it is in use.** They may become hot and could cause burns.
- **Cleaning.** Read and follow all instructions and warnings on the cleaning cream labels.
- Be sure you know which control knob operates each surface unit. Make sure you have turned on the correct surface unit.
- When preparing flaming foods under the hood, turn the fan on.
- **Do not store heavy items above the cooktop surface that could fall and damage it.**
- **Do not Use Decorative Surface Element Covers** - If an element is accidentally turned on, the decorative cover will become hot and possibly melt. Burns will occur if the hot covers are touched. Damage may also be done to the cooktop.
- Appliance is not intended to be operated by means of an external timer or separate remote-control system.

**SAVE THESE INSTRUCTIONS**

---

## ELECTRICAL SAFETY

---

Use factory installed flexible cord to connect to power supply only, do not use power supply cord kit.

- ★ • The cooktop should be serviced only by qualified service personnel. Repairs carried out by unqualified individuals may cause injury or a serious malfunction. If your appliance is in need of repair, contact a Samsung authorized service center. Failure to follow these instructions may result in damage and void the warranty.
- Flush - mounted appliances may be operated only after they have been installed in cabinets and workplaces that conform to the relevant standards. This ensures that the appliances are installed in compliance with the appropriate safety standards.
- If your appliance malfunctions or if fractures, cracks, or splits appear:
  - switch off all cooking zones
  - unplug the cooktop from the AC wall outlet
  - contact your local Samsung service center.

### ⚠ WARNING

If the surface is cracked, switch off and unplug the appliance to avoid the possibility of electrical shock. Do not use your cooktop until the glass surface has been replaced.

---

## CHILD SAFETY

---

### ⚠ WARNING

- This appliance is not intended for use by young children or infirm persons without the adequate supervision of a responsible adult.
- Young children should be supervised to ensure that they do not play with the appliance.
- The cooking zones will become hot when you cook. To keep small children from being burned, always keep them away from the appliance while you are cooking.

### ⚠ WARNING

Accessible parts may become hot during use. To avoid burns, young children should be kept away.

**SAVE THESE INSTRUCTIONS**



## Important safety instructions

---

### VENTILATING HOOD

---

- ★ • **Clean ventilating hoods frequently.** Do not let grease accumulate on the hood or filter.
- **When flaming foods under the hood, turn the fan on.**

### GLASS/CERAMIC COOKING SURFACES

---

- ☐ • **DO NOT TOUCH SURFACE UNITS OR AREAS NEAR UNITS.** Surface units may be hot even though they are dark in color. Areas near surface units may become hot enough to cause burns. During and after use, do not touch, or let clothing or other flammable materials contact the surface units or areas near the units until they have had sufficient time to cool. Among these areas are the cook-top and the facing of the cooktop.
- **Do not cook on a broken cooktop.** If the cooktop should break, cleaning solutions and spillovers may penetrate the broken cooktop and create a risk of electric shock. If your cooktop breaks, contact an authorized Samsung service center immediately.

**SAVE THESE INSTRUCTIONS**

- ★ • **Clean the cooktop with caution.** If a wet sponge or cloth is used to wipe spills on a hot cooking area, be careful to avoid steam burns. Some cleaners can produce noxious fumes if applied to a hot surface.

### CRITICAL INSTALLATION WARNINGS

---

#### ⚠ WARNING

- ★ • This appliance must be installed by a qualified technician or service company.
  - Failing to have a qualified technician install the cooktop may result in electric shock, fire, an explosion, problems with the product, or injury.
- Unpack the cooktop, remove all packaging material and examine the cooktop for any damage such as dents. If there is any damage, do not operate the cooktop and notify your dealer immediately.
- Plug the power cord into a properly grounded outlet with the proper configuration. Your cooktop should be the only item connected to this circuit.
- Keep all packaging materials out of the reach of children. Children may use them for play and injure themselves.

**SAVE THESE INSTRUCTIONS**

- ★ • Install the cooktop on a sturdy, level cabinet that can support its weight.
  - Failing to do so may result in problems with the cooktop.
- ⚡ • This appliance must be properly grounded.
  - Do not ground the appliance to a gas pipe, plastic water pipe, or telephone line.
    - This may result in electric shock, fire, an explosion, or problems with the product.
  - Do not cut or remove the grounding prong from the power cord under any circumstances.
  - Connect the cooktop to a circuit that provides the correct amperage.
- ☒ • Do not install this appliance in a humid, oily or dusty location, or in a location exposed to direct sunlight or water (rain drops).
  - This may result in electric shock or fire.
  - Do not use a damaged power cord or loose wall socket.
    - This may result in electric shock or fire.
  - Do not pull or bend the power cord excessively.
  - Do not twist or tie the power cord.

**SAVE THESE INSTRUCTIONS**

- ☒ • Do not hook the power cord over a metal object, place a heavy object on the power cord, or insert the power cord between objects.
  - This may result in electric shock or fire.
- ✎ • If the power cord is damaged, contact your nearest Samsung service center.

## CRITICAL USAGE WARNING

### ⚠ CAUTION

- ★ • If the appliance is flooded by any liquid, please contact your nearest Samsung service center. Failing to do so may result in electric shock or fire.
- If the appliance produces a strange noise, a burning smell, or smoke, unplug the power plug immediately and contact your nearest Samsung service center.
  - Failing to do so may result in electric shock or fire.
- In the event of a gas leak (such as propane gas, LP gas, etc.), ventilate the area immediately. Do not touch the power cord. Do not touch the appliance.
  - A spark may result in an explosion or fire.

**SAVE THESE INSTRUCTIONS**

## Important safety instructions

---

- ★ • Take care not to contact the cooktop surface with your body while cooking or just after cooking.
  - Failing to do so may result in burns.
- Always observe safety precautions when using your cooktop. Never try to repair the cooktop on your own - there is dangerous voltage inside. If the cooktop needs to be repaired, contact an authorized Samsung service center near you.
- If you use the appliance when it is contaminated by foreign substances such as food waste, it may result in a problem with the appliance.
- ☒ • Do not attempt to repair, disassemble, or modify the appliance yourself.
  - Since a high voltage current enters the product chassis, it may result in electric shock or fire.
  - When a repair is needed, contact your nearest Samsung service center.
- 🔧 • If any foreign substance such as water has entered the appliance, contact your nearest Samsung service center.
  - Failing to do so may result in electric shock or fire.
- ☒ • Do not touch the power cord with wet hands.
  - This may result in electric shock.

**SAVE THESE INSTRUCTIONS**

- ☒ • Do not turn the appliance off while an operation is in progress.
  - This may cause a spark and result in electric shock or fire.
- Keep all packaging materials well out of the reach of children, as packaging materials can be dangerous to children.
  - If a child places a plastic bag over his or her head, the child can suffocate.
- Do not let children or any person with reduced physical, sensory, or mental capabilities use this appliance unsupervised.
- Keep pets away from the appliance because pets may step on the controls of the appliance, causing a malfunction.
- Make sure that the appliance's controls and cooking areas are out of the reach of children.
  - Failing to do so may result in electric shock, burns, or injury.
- Do not use or place flammable sprays or objects near the cooktop.
  - Flammable items or sprays can cause fires or an explosion.

**SAVE THESE INSTRUCTIONS**

- 
- ☐ • Do not insert fingers, foreign substances, or metal objects such as pins or needles into inlets, outlets, or holes. If foreign substances are inserted into any of these holes, contact your product provider or nearest Samsung service center.
  - Never use this appliance for purposes other than cooking.
    - Using the appliance for any purpose other than cooking may result in fire.
  - Never heat plastic or paper containers and do not use them for cooking.
    - Failing to do so may result in a fire.
  - Do not heat food wrapped in paper from magazines, newspapers, etc.
    - This may result in a fire.
  - Do not hold food in your bare hands during or immediately after cooking.
    - Use cooking gloves. The food may be very hot and you could burn yourself.
    - As the handle and cooktop surfaces may be hot enough to cause burns after cooking, use cooking gloves to protect your hands from burns.

## SAVE THESE INSTRUCTIONS

---

## USAGE CAUTIONS

### ⚠ CAUTION

- ★ • If the surface is cracked, turn the appliance off.
  - Failing to do so may result in electric shock.
- Dishes and containers can become hot. Handle with care.
- Hot foods and steam can cause burns. Carefully remove container coverings, directing the steam away from your hands and face.
- Remove lids from baby food jars before heating. After heating baby food, stir well to distribute the heat evenly. Always test the temperature by tasting before feeding the baby. The glass jar or the surface of the food may appear to be cooler than the interior, which can be hot enough to burn an infant's mouth.
- Take care as beverages or food may be very hot after heating.
  - Especially when feeding a child, make sure that the food or beverage has cooled sufficiently.

## SAVE THESE INSTRUCTIONS

## Important safety instructions

---

- ★ • Take care when heating liquids such as water or other beverages.
  - Make sure to stir during or after cooking.
  - Avoid using a slippery container with a narrow neck.
  - Wait at least 30 seconds after heating before removing the heated liquid.
  - Failing to do so may result in an abrupt overflow of the contents and cause burns.
- ☒ • Do not stand on top of the appliance or place objects (such as laundry, lighted candles, lighted cigarettes, dishes, chemicals, metal objects, etc.) on the appliance.
  - This may result in electric shock, fire, problems with the product, or injury.
- Do not operate the appliance with wet hands.
  - This may result in electric shock.
- Do not spray volatile substances such as insecticide onto the surface of the appliance.
  - As well as being harmful to humans, it may also result in electric shock, fire, or problems with the product.

**SAVE THESE INSTRUCTIONS**

- ☒ • Do not put your face or body close to the appliance while cooking.
  - Take care that children do not come too close to the appliance.
  - Failing to do so may result in children burning themselves.
- Do not scratch the glass of the cooktop with a sharp object.
  - This may result in the glass being damaged or broken.
- Do not store anything directly on top of the appliance when it is in operation.
- Do not over-heat food.
  - Overheating food may result in a fire.

**SAVE THESE INSTRUCTIONS**



---

## CRITICAL CLEANING WARNINGS

---

### CAUTION

-  Do not clean the appliance by spraying water directly on to it.
- Do not use benzene, thinner, or alcohol to clean the appliance.
  - This may result in discoloration, deformation, damage, electric shock, or fire.
- Take care not to hurt yourself when cleaning the appliance (externally or internally).
  - You may hurt yourself on the sharp edges of the appliance.
- Do not clean the appliance with a steam cleaner.
  - This may result in corrosion.
- Keep the cooktop surface clean. Food particles or spattered oils stuck to the cooktop surface can cause paint damage and reduce the efficiency of the cooktop.

---

## Before you start

---

### About induction cooktop cooking

---

#### CAUTION

##### BEFORE COOKING

- Do not use the Induction cooktop surface as a cutting board.
- Do not place or store items that can melt or catch fire on the Induction cooktop, even when it is not being used.
- Turn the induction cooktop on only after placing the cookware on it.
- Do not store heavy items above the cooktop surface. They could fall and damage it.

#### CAUTION

##### DURING COOKING

- Metallic objects such as knives, forks, spoons, and lids should not be placed on the induction cooktop surface since they can get hot.
- After use, switch off the induction element using its control. Do not rely on the pan detector.
- Use this appliance for normal cooking and frying in the home only. It is not designed for commercial or industrial use.
- Never use the induction cooktop to heat the room.
- Take care when plugging electrical appliances into a power outlet near the cooktop. Power cords must not come into contact with the cooktop.
- Overheated fat and oil can catch fire quickly. Never leave surface units unattended when preparing foods in fat or oil, for example, when cooking french fries.
- Turn the cooking zones off after use.
- Never place combustible items on the induction cooktop. It may cause a fire.
- Do not use the induction cooktop to heat aluminium foil, products wrapped in aluminium foil, or frozen foods packaged in aluminium cookware.
- There is the risk of burns from the appliance if used carelessly.
- Do not let cables from electrical appliances touch hot cookware or the hot surface of the induction cooktop.

## Before you start

- Do not use the induction cooktop to dry clothes.
- Never store flammable materials such as aerosols and detergents in the drawer or cupboards under the induction cooktop.
- Users with Pacemakers or Active Heart Implants must keep their upper body at least 1 ft. (30 cm) from the induction cooking zones when they are turned on. If in doubt, you should consult the manufacturer of your device or your doctor.

### CAUTION

#### AFTER COOKING

- Do not touch the induction elements until they have cooled down.
- The surface can stay hot for some time after cooking is complete. If you touch the surface before it has had time to cool down sufficiently, you can burn yourself.
- Immediately clean spills on the cooking area to prevent a tough cleaning chore later.
- After you have activated elements on the cooktop, the internal fan may come on for cooling purposes.
- The fan activation time may differ depending on the temperature of the internal sensor. (10 minutes or 20 minutes)
- If you have cabinet storage directly above the cooking surface, make sure that the items in the cabinet are infrequently used and can be safely stored in an area subjected to heat. Temperatures may be unsafe for items such as volatile liquids, cleaners, or aerosol sprays.

### CAUTION

If the cooktop is installed above an oven, do not use the cooktop while the oven's Self-cleaning function is on.

## Location of the induction cooktop elements and controls

### Cooking zones

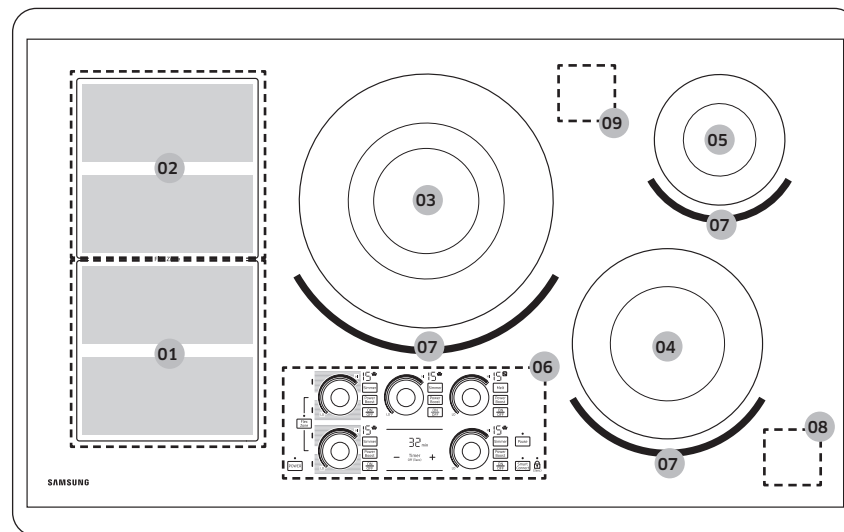

- |   |  |
|---|--|
| <b>01</b> Induction front Wide Flex zone:<br>1800 W. With Power Boost,<br>2600 W. | <b>02</b> Induction rear Wide Flex zone:<br>1800 W. With Power Boost,<br>2600 W. |
| <b>03</b> Center: 11", 3600 W. With Power<br>Boost, 4800 W                        | <b>04</b> Right front: 8", 2200 W. With<br>Power Boost, 3200 W.                  |
| <b>05</b> Right rear: 6", 1400 W. With Power<br>Boost, 2000 W.                    | <b>06</b> Control Panel  |
| <b>07</b> Virtual Flame   | <b>08</b> Wi-Fi communication area   |
| <b>09</b> Bluetooth communication area  |  |

### NOTE

Do not put cookware either on the Bluetooth or Wi-Fi communication area.

## Control Panel

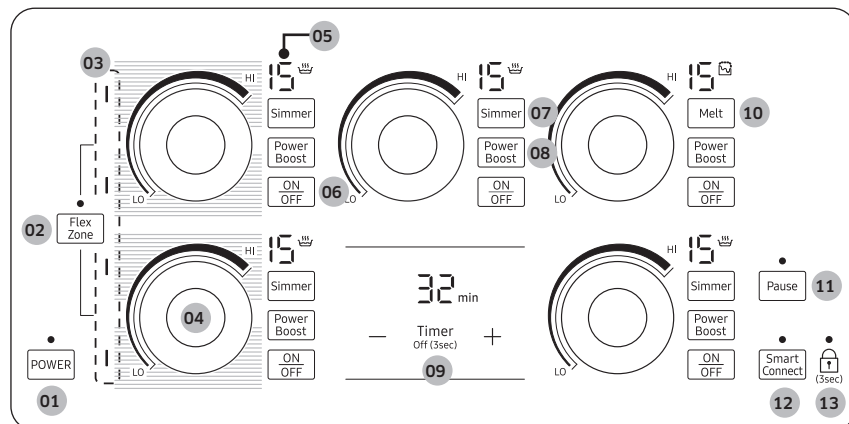

- |   |  |
|---|--|
| 01 Power  | 02 Flex Zone selector                    |
| 03 Flex zone indicator                            | 04 Heat setting selector (Magnetic Knob) |
| 05 Indicators for heat settings and residual heat | 06 Cooking Zone selector                 |
| 07 Simmer selector (☪)                            | 08 Power Boost selector                  |
| 09 Timer  | 10 Melt selector (M)                     |
| 11 Pause  | 12 Smart Connect                         |
| 13 Child lock                                     |  |

## Virtual flame technology

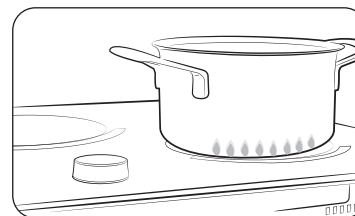

Virtual flame technology creates the appearance of flames when you turn on an induction element.

- Virtual flame technology is available only on the right burner.
- The virtual flame may look different depending on the appearance, size, or position of the cookware. (For the best results, use cookware that matches the element size. Cookware that is too large can cover the virtual flame. Cookware that is too small can cause the virtual flame to be ill-formed.)
- Impurities on the cookware bottom or the cooktop surface can cause the virtual flame to be ill-formed or incomplete. Clean the cookware or the cooktop surface before using them.

### NOTE

For optimal performance of the virtual flame, we recommend using the cookware that satisfies the following conditions.

Bottom size	11": 260 ~ 280 mm
	8": 200 ~ 220 mm
	6": 135 ~ 150 mm
Surface shape	Horizontal Hair-Line
Material	Stainless

# Before you start

## Magnetic Knob

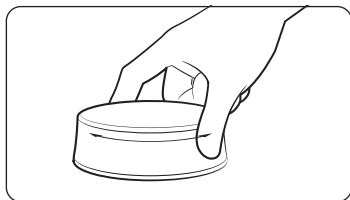

The magnetic knob is a detachable control knob with a magnetic base you can use to set and adjust the power level of any of the induction elements on your cooktop easily and intuitively. To use the magnetic knob:



1. Place it in the center of the element control of your choice. The knob's magnet holds it in place.
2. Press the **POWER** key to turn on the cooktop, and then press the element's **ON/OFF** key within 20 seconds.
3. Grasp and turn the magnetic knob to set the element's power level.

With the cooktop powered on, if you put the magnetic knob over an unused element on the control panel, the cooktop recognizes the knob and sets the power level to 0. Then, you can change the power level using the knob.

### NOTE

You can also set the power level by touching the element control with your finger. See page **19**.

## Residual heat indicator

When an individual cooking zone or the cooktop is turned off, the presence of residual heat is shown with an ,  (for "hot") in the digital display of the appropriate cooking zones. Even after the cooking zone has been switched off, the residual heat indicator goes out only after the cooking zone has cooled. You can use the residual heat for thawing or keeping food warm.

### NOTE

The uppercase '' indicates higher temperatures than the lowercase ''.

### WARNING

As long as the residual heat indicator is illuminated, there is a risk of burns.

### WARNING

If the power supply is interrupted, the ,  symbol will go out and information about residual heat will no longer be available.

However, it may still be possible to burn yourself. This can be avoided by always taking care when near the cooktop.

## Cooking areas

- The cooking areas on your cooktop are identified by permanent circles on the glass cooking surface. For the most efficient cooking, fit the pan size to the element size.
- **Pans should not extend more than ½" to 1" beyond the cooking area.**
- For more information on selecting proper types of cookware, refer to the section "Use quality cookware in good condition". See page **25**.

## Initial cleaning

Wipe the ceramic glass surface with a damp cloth and ceramic cooktop glass cleaner.

### ⚠ WARNING

Do not use caustic or abrasive cleaners. The surface could be damaged.

## Digital display

- selected heat settings
- Residual heat (Still Hot)
- Residual heat
- The child lock is activated.
- message. A touch key has been touched and held for more than 8 seconds.
- message. The cooktop has overheated because of abnormal operation. (Example : An element was turned on with empty cookware on top.)
- The cookware is unsuitable or too small or no cookware has been placed on the cooking zone.
- message. The power applied to the cooktop is too high or low.

## Safety shutoff

- If the cooktop overheats because of abnormal operation, will be displayed and the cooktop will turn off.
- If cookware is unsuitable or too small or no cookware has been placed on the cooking zone, will be displayed. After 30 seconds, the corresponding cooking zone will turn off.

### Other reasons why a cooking zone will switch itself off

All cooking zones will switch themselves off if liquid boils over and lands on the control panel.

The automatic shutoff will also be activated if you place a damp cloth on the control panel. In both of these instances, you will need to turn the cooktop on again using the main **POWER** key after the liquid or the cloth has been removed.

# Operation

## Switching the appliance on

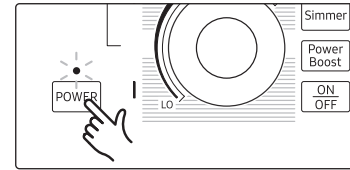

Turn the cooktop on by touching the **POWER** key for approximately 1 second.

### NOTE

After you have touched the **POWER** key to switch on your cooktop, you must select a cooking zone or element and a power setting within approximately 20 seconds. Otherwise, the cooktop will switch itself off for safety reasons.

## Selecting a cooking zone and power setting

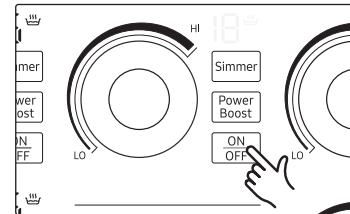

1. To select an element or cooking zone, touch the **ON/OFF** key of the zone or element.
  - The digital displays will show .

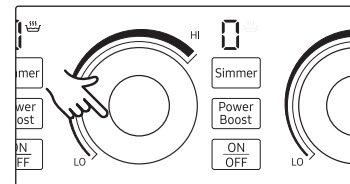

2. To set or adjust the power level, run your finger clockwise or counterclockwise along the surface of the element or zone control as shown in the illustration.
  - If you do not set a power level after selecting an element, the element will turn off automatically after 10 seconds.
  - You can also use the magnetic knob to control the element or cooking zone. See page **18**.



# Operation

## NOTE

If you try to rotate the magnetic knob by grabbing its side or pushing it, it will not work. Grasp the knob with two fingers, and then turn it.

## NOTE

If you turn the magnetic knob while wearing oven gloves, the knob will not work. You must be bare handed.

## Recommended settings

The power levels in the table below are guidelines. The power settings required for various cooking methods depend on a number of variables, including the quality of the cookware being used and the type and amount of food being cooked.

SETTING	POWER LEVELS	TYPE OF COOKING
HIGH/BOOST	14-15 Boost	<ul style="list-style-type: none"><li>Bringing water to a boil</li><li>Start food cooking</li><li>Quickly searing meat</li></ul>
MEDIUM HIGH	10-13	<ul style="list-style-type: none"><li>Holding a rapid boil</li><li>Deep fat frying, pan frying, stir frying</li></ul>
MEDIUM	7-9	<ul style="list-style-type: none"><li>Cooking sauces and gravies</li><li>Steaming vegetables</li></ul>
MEDIUM LOW	4-6	<ul style="list-style-type: none"><li>Maintaining a slow boil</li><li>Keeping foods cooking, poaching, stewing</li></ul>
LOW	1-3 Melt, Simmer	<ul style="list-style-type: none"><li>Melting chocolate or butter</li><li>Keeping foods warm</li><li>Simmering</li></ul>

## Griddle (Flex zone)

Preheat the griddle (MEDIUM HIGH or HIGH).

Type of cooking	Setting
Pancakes	MEDIUM LOW
Fried eggs	MEDIUM LOW
French toast	MEDIUM
Bacon, sausages	MEDIUM - cook to desired brownness
Hamburgers	MEDIUM HI - cook to desired doneness

## NOTE

- The power settings indicated in the table above are provided only as guidelines for your reference.
- You will need to adjust the power settings according to specific cookware and foods.

## Switching the appliance off

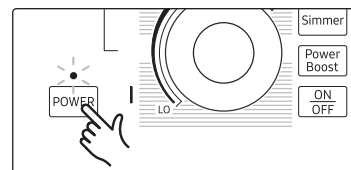

To completely switch off the appliance, touch the **POWER** key for 1 second.

## NOTE

After you switch off a single cooking zone or the entire cooking surface, the presence of residual heat will be indicated in the digital displays of the corresponding cooking zones by an **H** or **h** (for “hot”).

## Using the child lock

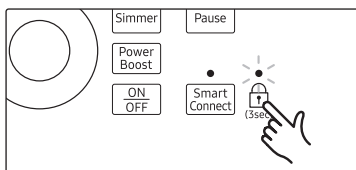

You can use the child lock to safeguard against a child unintentionally turning on a cooking zone and activating the cooking surface. Also, the control panel, with the exception of the **POWER** key, can be locked to prevent the settings from being changed unintentionally, for example, by wiping over the panel with a cloth.

### Switching the child lock On/Off

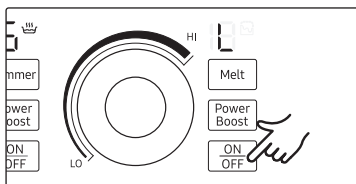

1. Touch the **Child Lock**  key for approximately 1 seconds. An acoustic signal will sound as confirmation.



2. Touch any control key.  will appear in the displays, indicating the child lock has been activated.
3. To switch the child lock off, touch the **Child Lock**  key again for 1 seconds. An acoustic signal will sound as confirmation.

#### NOTE

- If you activate the child lock while the cooktop is operating, touch the **POWER** button to turn the cooktop off for safety reasons.
- If the child lock is enabled when the cooktop is not operating, all buttons will be disabled including the **POWER** button.

## Timer

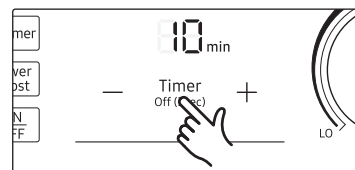

1. Press the **Timer** key. The number 10 will be displayed above the timer display.

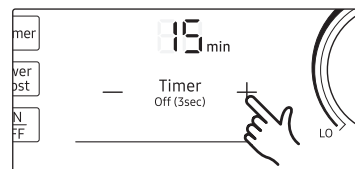

2. Use the **Timer setting selectors** (+ or -) to set the desired amount of time. Then, press **Timer** key again.

#### NOTE

The timer can be adjusted from 0 to 99.

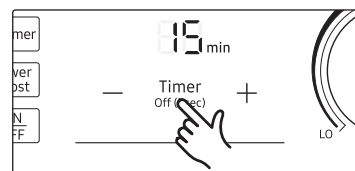

3. To cancel the timer settings, hold down the **Timer** key for 3 seconds.

#### NOTE

- To change the settings quicker, touch and hold any of the + or - control keys until the desired value is reached.
- When the timer is terminated, it sounds a beep 4 times. However, the cooking zone will not be turned off.

# Operation

## Power boost control

The **Power Boost P** function makes additional power available to each cooking zone (for example, when you want to bring a large volume of water to a boil).

Cooking zones	Max Boost time
11"	8 min
8"	10 min
6"	10 min
Front or Rear Flex Plus	10 min
Complete Flex Plus	5 min

When the Max Boost times expire, the cooking zones automatically return to power level 15.

### NOTE

In certain circumstances, the **Power Boost P** function may be deactivated automatically to protect the internal electronic components of the cooktop.

## Power management

The cooking zones have a maximum power available to them. If this power range is exceeded in a cooking zone when you switch on the **Power Boost P** function, Power Management automatically reduces the power setting of the cooking zone.

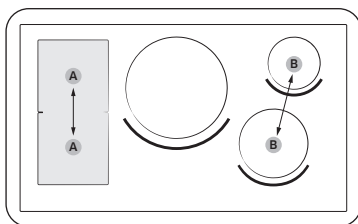

- A. Paired cooking zone
- B. Paired cooking zone

The indicator for the cooking zone alternates for some seconds between the set power setting and the maximum possible power setting. Then, the indicator changes from the set power setting to the maximum possible power setting.

## Pause

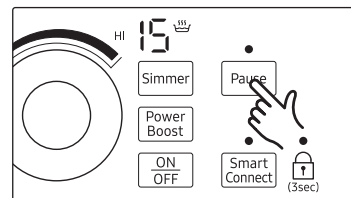

The **Pause** function simultaneously switches all cooking zones that are switched on to the low power setting. This function can be used to briefly interrupt and then continue the cooking process e.g. to take a telephone call.

When the **Pause** function is activated, all touch keys except for the **Pause**, **Child Lock** (🔒), **ON/OFF**, and **POWER** keys are disabled. To resume cooking, touch the **Pause** button. The cooking zones return to their previous setting.

	Control Panel	Display
To Switch On	Touch <b>Pause</b> key	🔒
To Switch Off	Touch <b>Pause</b> key	Return to previous power level

### NOTE

Timer functions are not stopped by the **Pause** function.

## Flex zone

You can use the Flex Zone function to operate and control the two elements on the left side simultaneously, as a single cooking zone, and then use the zone for large cookware. (Examples: oval cookware, large spaghetti pots, etc.)

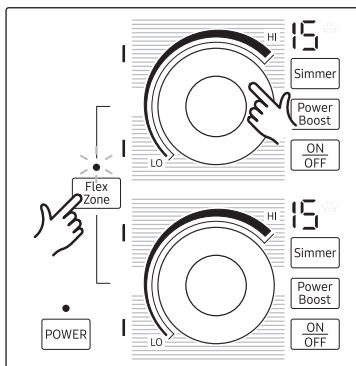

1. Touch the **Flex Zone** selector. The two left elements are synched and will now work together.
2. Use an element control as shown to adjust the power level of the two left elements. The power setting displays of the two left elements (front and rear) will change together.
3. To disable the Flex Zone function, touch the **Flex Zone** selector.
  - You can also use the magnetic knob to control the two elements. See page **18**.

## Flex zone Indicator

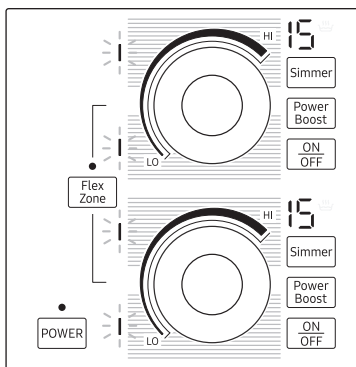

The Flex Zone indicator uses pan detection to display the active zone when the Flex Zone function is enabled.

### NOTE

If an inappropriate pot or pan is placed on the cooking zone, the indicator blinks. If the pot or pan is not removed, the cooking zone turns off.

Any one element of the Flex zone may not operate properly with a small pan or pot if it slants to one element even slightly.

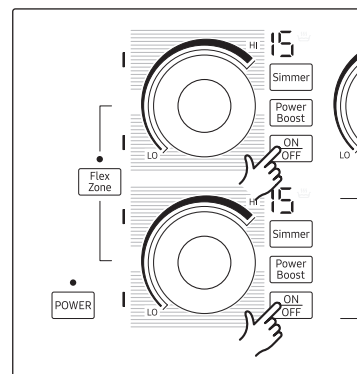

### NOTE

To turn the synched elements off, touch the **ON/OFF** key for any synched element. The two synched elements will turn off simultaneously.

## Size of pans

Induction cooking zones adapt automatically to the size of the bottom of the cookware up to a certain limit. However the magnetic part of the bottom of the cookware must have a minimum diameter depending upon the size of the cooking zone.

Cooking zones	Minimum diameter of the bottom of the cookware
Front or Rear Flex zone plus	5.5 inch (140 mm)
Flex zone plus	9.4 inch (240 mm) (long side dimension), oval, fish kettle

# Operation

## Flex zone Plus

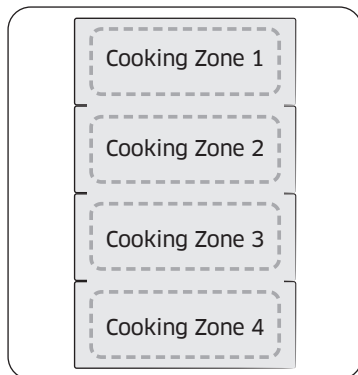

The Flex zone is the large cooking area located on the left side of the hob (see the figure below) that is specially designed to accommodate multiple pots and pans of varying shapes and sizes at once. The Flex zone has four zones that are operated by individual inductors, allowing you to cook regardless of where cookware is placed on a cooking zone.

With Flex zone Plus, you can use a combination of different cooking zones to enlarge the cooking area. See the table below for the corresponding sensor to touch to activate the different combinations.

Cooking Zone	1 burner	2 burner	3 burner	4 burner
1	[1 burner icon]	[2 burner icon]	[3 burner icon]	[4 burner icon]
2	[1 burner icon]	[2 burner icon]	[3 burner icon]	[4 burner icon]
3	[1 burner icon]	[2 burner icon]	[3 burner icon]	[4 burner icon]
4	[1 burner icon]	[2 burner icon]	[3 burner icon]	[4 burner icon]

### NOTE

- When using only one cooking zone, the diameter of the bottom of the cookware must be less than 14 cm.
- The hob may take 5-10 seconds to recognize the position of cookware.
- Noises may occur while the hob recognizes the cookware.
- Do not remove cookware during cooking. For safety purposes, the hob automatically stops if cookware has been removed for more than 5 seconds.

## Sound on/off

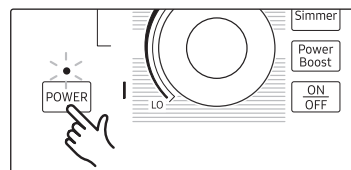

1. Touch the **POWER** key for approximately 1 second.

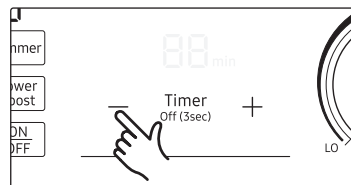

2. Touch the **—** key for 3 seconds within 10 seconds of pressing the **POWER** key.

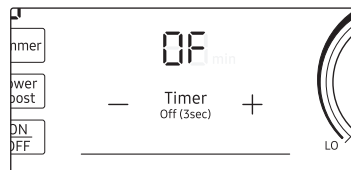

3. Sound will turn off and **0F** will appear in the Timer display.

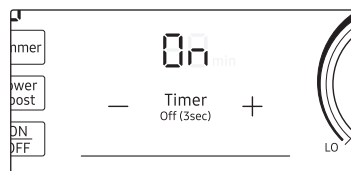

4. To change the Sound setting, repeat Steps 1 and 2. Sound will turn ON and **0n** will appear in the Timer display.

### NOTE

To change the Sound On/Off setting, you must operate the Sound On/Off function within 10 seconds of turning the power on.



## Virtual flame on/off

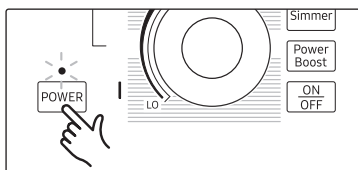

1. Touch the **POWER** key for approximately 1 second.

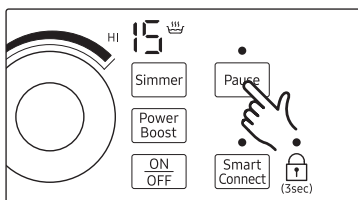

2. Touch the **Pause** key for 3 seconds within 10 seconds of pressing the **POWER** key.

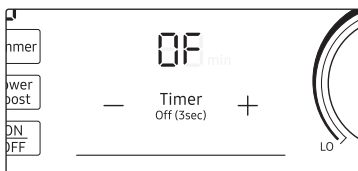

3. Virtual flame will turn off and **0F** will appear in the Timer display.

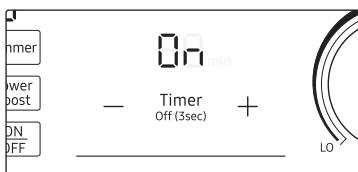

4. To change the Virtual flame setting, repeat Steps 1 and 2. Virtual flame will turn ON and **0n** will appear in the Timer display.

### **NOTE**

To change the Virtual flame On/Off setting, you must operate the Virtual flame On/Off function within 10 seconds of turning the power on.

## Before using the cooktop

### Use quality cookware in good condition

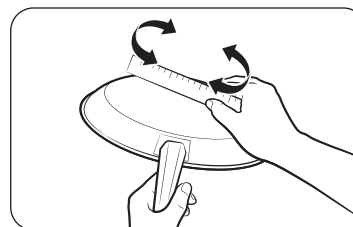

The cookware used with the cooktop surface should have flat bottoms that make good contact with the entire surface of the Cooking Zone. Check for flatness by rotating a ruler across the bottom of the cookware. Be sure to follow all the recommendations for using cookware.

### Also remember to

- Use cookware made with the correct material for induction cooking. See "Cookware for induction cooking zones" on page 26.
- Use quality cookware with heavier bottoms for better heat distribution. This provides for more even cooking results.
- The pan size should match the amount of food being prepared.
- **Do not let pans boil dry.** This may cause permanent damage in the form of breakage, fusion, or marring that can affect the ceramic cooktop. (This type of damage is not covered by your warranty).
- Do not use dirty pans with grease buildup. Always use pans that are easy to clean after cooking.

### **CAUTION**

- The Cooking Zones may appear to be cool while turned ON and after they have been turned OFF. The glass surface may be HOT from residual heat transferred from the cookware and burns may occur.
- **DO NOT TOUCH HOT COOKWARE or PANS directly with your hands.** Always use oven mitts or pot holders to protect your hands from burns.
- **DO NOT SLIDE cookware across the cooktop surface.** Doing so may permanently damage the appearance of the ceramic cooktop.

# Operation

## CORRECT

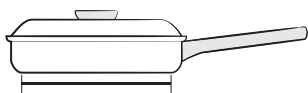

Flat pan bottom & straight sides.

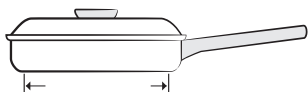

Pan size meets or exceeds the recommended minimum size for the Cooking Zone. See "Using the correct size cookware".

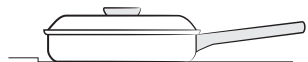

Pan rests completely on the Cooktop surface.



Pan is properly balanced.

## INCORRECT

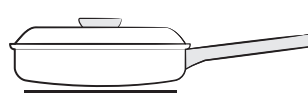

Curved or warped pan bottoms or sides.

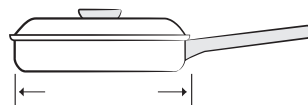

Pan does not meet the minimum size required for the Cooking Zone used. See "Using the correct size cookware".

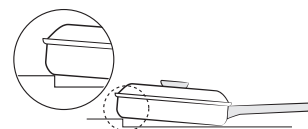

Pan bottom rests on cooktop trim or does not rest completely on the cooktop surface.



Heavy handle tilts pan.

### NOTE

ANY one of the incorrect conditions listed above may be detected by the sensors located below the ceramic cooktop surface. If the cookware does not meet one or more of these conditions, one or more of the Cooking Zones will not heat, and settings will flash in the affected Cooking Zone display. Correct the problems before attempting to activate the cooktop.

## Cookware for induction cooking zones

The Induction element can only be turned on when cookware with a magnetic base is placed on one of the cooking zones. You can use the cookware identified as suitable below.

### Cookware material

Cookware material	Suitable
Steel, Enamelled steel	Yes
Cast iron	Yes
Stainless steel	If appropriately labelled by the manufacturer
Aluminium, Copper, Brass	No
Glass, Ceramic, Porcelain	No

### NOTE

- Cookware appropriate for induction cooking is labelled as suitable by the manufacturer.
- Certain cookware can make noise when being used on induction cooking zones. These noises do not indicate that the cooktop is malfunctioning and do not affect its operation in any way.

## Using the correct size cookware

- The Induction Cooking Zones require that you use pots and pans of a **minimum** size or larger at each location. The inner ring of each Cooking Zone is your guide to the correct **minimum** pan size. The pan bottom must fully cover the inner ring for proper cooking to occur.
- The thicker outer ring at each Cooking Zone is helpful to determine the **maximum** pan size. After centering the cookware on the cooktop, make sure the cookware does not extend more than 1/2" beyond the thicker line on the Cooking Zone. The pan must fully contact the glass surface without the bottom of the pan touching the metal cooktop trim.

### NOTE

- If a pan made of the correct material is centered properly on any of the active Cooking Zones but is too small, the affected Cooking Zone display will flash and the pan will not heat.
- If cookware is unsuitable or too small or no cookware has been placed on the cooking zone,  will be displayed. After 30 seconds, the corresponding cooking zone will turn off.

## Pot and pan sizes

Induction cooking zones adapt automatically to the size of the bottom of the cookware up to a certain limit. However the magnetic part of the bottom of the cookware must have a minimum diameter depending upon the size of the cooking zone.

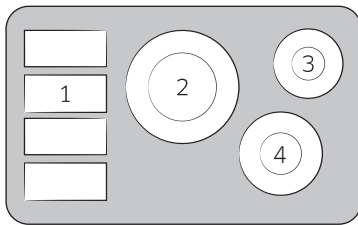

Cooking zones	Minimum diameter of the bottom of the cookware
1	Front or Rear Flex zone plus 5.5 inch (140 mm) (Long side diameter 9.4 inch (240 mm))
2	6.3 inch (160 mm)
3	3.9 inch (100 mm)
4	5.5 inch (140 mm)

## Operating noises

You may hear the following operational noises:

- Cracking noises** : You may hear a cracking noise when you are using cookware made of two or more materials.
- Whistling** : A whistling noise occurs when both back burners are in use. This is caused by vibrations. Whistling can vary depending on the weight or material of the cookware or the type of food you are cooking. (The noise can be reduced by using thicker cookware.)
- Humming** : You may hear a low humming when you set an element to a high power setting. This sound is generated by energy transmission, and it will disappear when cooktop is turned off.
- Clicking** : Electric switches are operating.
- Hissing, Buzzing** : You may hear a fan noise during cooktop operation. You may continue to hear it even after the cooktop is turned off. This is normal. The fan runs to cool down the temperature inside the cooktop. It will automatically shut itself off after a short period of time.

These noises are normal and do not indicate any defects.

# Operation

## Using suitable induction cookware

### Suitability test

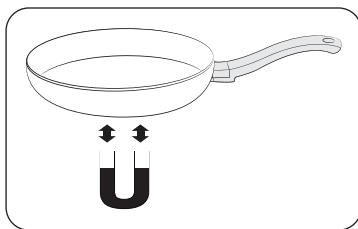

Cookware is suitable for induction cooking if a magnet sticks to the bottom of the cookware and the cookware is labelled as suitable by the cookware manufacturer.

### Better pans produce better results

- You can recognize good pots and pans by their bases. The base should be as thick and flat as possible.
- When buying new pots or pans, pay particular attention to the diameter of the base. Manufacturers often give only the diameter of the upper rim.
- Do not use pans which have damaged bases with rough edges or burrs. You can scratch the ceramic cooktop permanently if you slide a pot or pan with a damaged base across the surface.
- When cold, pan bases are normally bowed slightly inwards (concave). They should never be bowed outwards (convex).
- If you want to use a special type of pot or pan, for example, a pressure cooker, a simmering pan, or a wok, please follow the manufacturer's instructions.

### Energy saving tips

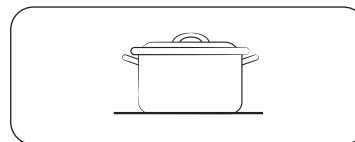

Right!

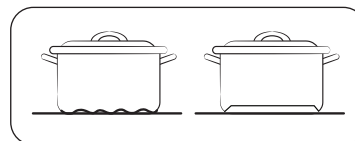

Wrong!

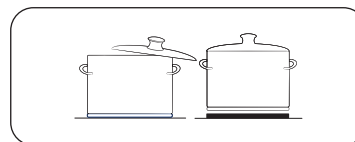

Wrong!

You can save valuable energy by observing the following points:

- Always position pots and pans before switching on the cooking zone.
- Dirty cooking zones and pan bases increase power consumption.
- When possible, position lids firmly on pots and pans so that the lids cover them completely.
- Switch the cooking zones off before the end of the cooking time and use the residual heat to keep food warm.

### Temperature detection

If for any reason the temperatures on any of the cooking zones exceeds the safety level, then the cooking zone will automatically reduce the heat to a lower power level.

When you have finished using the cooktop, the cooling fan will continue to run until the cooktop's electronics have cooled down. The cooling fan switches itself on and off depending upon the temperature of the electronics.

#### NOTE

If the induction cooktop overheats because of abnormal operation,  will be displayed and the induction cooktop will turn off.

## Protecting the cooktop surface

### Cleaning

- Clean the cooktop before using it for the first time.
- Clean your cooktop daily or after each use. This will keep your cooktop looking good and can prevent damage.
- If a spillover occurs while you are cooking, immediately clean the spill while it is hot to prevent a tough cleaning chore later. Using extreme care, wipe the spill with a clean, dry towel.
- **Do not** allow spills to remain on the cooking area or the cooktop trim for a long period of time.
- **Do not** use abrasive cleansing powders or scouring pads, which will scratch the cooktop.
- **Do not** use chlorine bleach, ammonia, or other cleansers not specifically recommended for use on a glass-ceramic surface.

### Preventing marks and scratches

- **Do not** use glass cookware. It may scratch the cooktop.
- **Do not** place a trivet or wok ring between the cooktop and a pan or wok. These items can mark or scratch the cooktop.
- Make sure the cooktop and the pan bottom are clean.
- **Do not** slide metal pans across the cooktop.

### Preventing stains

- **Do not** use a soiled dish cloth or sponge to clean the cooktop surface. A film will remain, which may cause stains on the cooking surface after the area is heated.
- Continuously cooking on a soiled surface can result in a permanent stain.

### Preventing other damage

- **Do not** allow plastic, sugar, or foods with high sugar content to melt onto the hot cooktop. Should this happen, clean immediately.
- **Do not** let a pan boil dry as this will damage the cooktop and the pan.
- **Do not** use the cooktop as a work surface or cutting board.
- **Do not** cook food directly on the cooktop. Always use the proper cookware.

## Using the smart connect feature

The cooktop has built in a Wi-Fi module that you can use to sync the cooktop with the SmartThings app. On the smartphone app, you can:

- monitor the operating status and the power level settings of the cooktop elements.
- check and change the timer settings.

Functions that can be operated from the SmartThings app may not work smoothly if communication conditions are poor or the product is installed in a place with a weak Wi-Fi signal.

### How to connect the cooktop

Before you can use the remote features of your Samsung cooktop, you must pair it to the SmartThings App.

1. Download and open the SmartThings app on your smart device.
2. Press the **POWER** key to turn the cooktop on.
3. Follow the app's instructions, and then touch and hold the **Smart Connect** key for 3 seconds.
4. While the connection is being made, the LED indicator above the **Smart Connect** key blinks. Once the process is complete, the indicator glows without blinking. Now the cooktop is connected successfully.
5. If the Smart Connect LED indicator does not turn on, follow the instruction in the app to reconnect.

### NOTE

- Make sure to set the Smart Connect function only when no hob operation is in process.
- For further instructions, refer to the web manual at [www.samsung.com](http://www.samsung.com)

### Wi-Fi On/Off

Touch the **Smart Connect** key to turn on or turn off the Wi-Fi connection.

## Using the hood control feature

This product features a Bluetooth device that you can use to connect the cooktop to Samsung hood control models. Through the Bluetooth connection, you can use the hood control function on the SmartThings app.

To find out more about Samsung hood control-enabled models, visit [www.samsung.com](http://www.samsung.com).

### To connect to a hood control model

1. Download and run the SmartThings App on your smartphone. Then, complete the Smart Connect procedure to connect to the cooktop.
2. Follow the Bluetooth instructions of the hood control model and activate the Bluetooth connection.
3. Touch and hold the **Smart Connect** and **Child lock** buttons simultaneously to make the Bluetooth connection. When the Bluetooth connection is successfully established, **bt** appears on the display.
4. Follow the instructions in the user manual of the hood control model and the App guide to use the hood control.

### NOTE

- If the Smart Connect connection is not successful, you cannot use the SmartThings App to monitor and control the hood.
- Without a Smart Connect connection to the cooktop, you can use a Bluetooth connection to pair the cooktop with the hood and sync them. To do this, follow steps 2 and 3 above.

## Maintaining your appliance

### Care and cleaning of the glass cooktop

#### Normal daily use cleaning

Use only a ceramic cooktop cleaner. Other creams may not be as effective.

By following these steps, you can maintain and protect the surface of your glass cooktop.

1. Before using the cooktop for the first time, clean it with a ceramic cooktop cleaner.
  - This helps protect the top and makes cleanup easier.
  - Daily use of a ceramic cooktop cleaner will help keep the cooktop looking new.
2. Shake the cleaning cream well. Apply a few drops of cleaner directly to the cooktop.
3. Use a paper towel or a cleaning pad for ceramic cooktops to clean the entire cooktop surface.
4. Use a dry cloth or paper towel to remove all cleaning residue. No need to rinse.

### WARNING

**DAMAGE** to your glass surface may occur if you use scrub pads other than those recommended.

### Removing burned-on residue

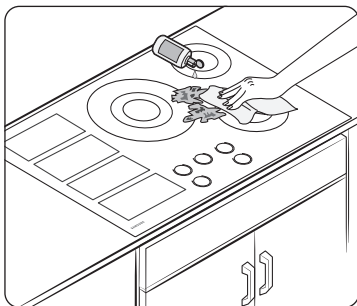

1. Allow the cooktop to cool.
2. Spread a few drops of ceramic cooktop cleaner on the entire burned residue area.
3. Using a cleaning pad for ceramic cooktops, rub the residue area, applying pressure as needed.
4. If any residue remains, repeat the steps listed above as needed.
5. For additional protection, after all residue has been removed, polish the entire surface by applying ceramic cooktop cleaner with a paper towel.

### Removing heavy, burned-on residue

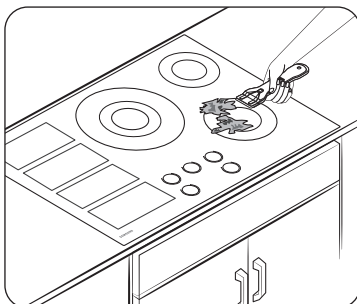

1. Allow the cooktop to cool.
2. Use a single-edge razor-blade scraper at approximately a 45° angle against the glass surface and scrape the soil. It will be necessary to apply pressure to remove the residue.
3. After scraping with the razor scraper, spread a few drops of ceramic cooktop cleaner on the entire burned residue area. Use a cleaning pad to remove any remaining residue. (Do not scrape the seal around the edges of the cooktop.)
4. For additional protection, after all residue has been removed, polish the entire surface by applying ceramic cooktop cleaner with a paper towel.

### Removing metal marks and scratches

1. Be careful not to slide pots and pans across your cooktop. It will leave marks on the cooktop surface. You can remove these marks by applying ceramic cooktop cleaner with a cleaning pad for ceramic cooktops.
2. If pots with a thin overlay of aluminum or copper are allowed to boil dry, the overlay may leave black discoloration on the cooktop. You should remove this discoloration immediately or it may become permanent.

#### **⚠ WARNING**

Carefully check the bottoms of pans for roughness that may scratch the cooktop.

### Cleaning the cooktop seal

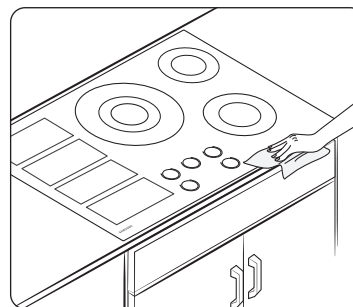

To clean the seal around the edges of the glass, lay a wet cloth on it for a few minutes, then wipe clean with a nonabrasive cleaner.

# Troubleshooting

## Potential for permanent damage to the glass surface

- Sugary spillovers (such as jellies, fudge, candy, syrups) or melted plastics can cause pitting of the surface of your cooktop. This is not covered under the warranty. You should clean the spill while it is still hot. Take special care when removing hot substances. Refer to the section below.
- When using a scraper, be sure it is new and the razor blade is still sharp. Do not use a dull or nicked blade.

## Cleaning sugary spills and melted plastic

1. Turn off all surface units. Remove hot pans.
2. Wearing an oven mitt, use a single-edge razor-blade scraper to move the spill to a cool area of the cooktop. Remove the spill with paper towels.
3. Any remaining spillover should be left until the surface of the cooktop has cooled.
4. Don't use the surface units again until all of the residue has been completely removed.

### NOTE

If pitting or indentations in the glass surface have already occurred, the cooktop glass will have to be replaced. In this case, service will be necessary.

## Troubleshooting

Samsung works hard to ensure that you don't have problems with your new electric cooktop. If you run into unexpected trouble, look first for a solution in the tables below. If you're still having trouble after trying the suggested solution, call Samsung at 1-800-SAMSUNG (1-800-726-7864).

Problem	Possible cause	Solution
The surface units will not maintain a rolling boil or will not cook fast enough.	You may be using inappropriate cookware.	Use pans which are flat and match the diameter of the surface unit selected.
	In some areas, the power (voltage) may be low.	Cover the pan with a lid until the desired heat is obtained.
The surface units will not turn on.	A fuse in your home may be blown or a circuit breaker may have tripped.	Replace the fuse or reset the circuit breaker.
	The cooktop controls are set improperly.	Check if the correct control is set for the surface unit you are using.
Areas of discoloration on the cooktop.	Food spillover was not cleaned.	Refer to the section on the care and cleaning of the glass cooktop on page 30.
	The surface is hot and the model features a light-colored cooktop.	This is normal. The surface may appear discolored when it is hot. This is temporary and will disappear as the glass cools.



Problem	Possible cause	Solution
The surface unit frequently cycles on and off.	The element will cycle on and off to maintain the power setting.	This is normal operation, and not a system failure. Cycling at the high power setting is normal and can occur if the cookware is too small for the cooktop element or if the cookware bottom is not flat. Use the cooktop as usual.
Scratches or abrasions on the cooktop surface.	The cooktop is being cleaned improperly.	Scratches are not removable. Tiny scratches will become less visible in time as a result of cleaning. Use ceramic glass top cleaning cream. Do not use chemical or corrosive agents. These agents may damage the surface of the product.
	Cookware with rough bottoms was used on the cooktop or there were coarse particles (eg. salt or sand) present between the cookware and the surface of the cooktop.	To avoid scratches, follow the recommended cleaning procedures. Make sure cookware bottoms are clean before use, and use cookware with smooth bottoms.
	Cookware has been slid across the cooktop surface.	

Problem	Possible cause	Solution
Brown streaks or specks.	Boilovers have been cooked onto the surface.	<ul style="list-style-type: none"> <li>Wait until the surface cools down. Then, use a single-edge razor-blade scraper at approximately a 45° angle against the glass surface to remove the soil.</li> <li>See the section on the care and cleaning of the glass cooktop on page 30.</li> </ul>
Areas of discoloration with metallic sheen.	Mineral deposits from water and food have been left on the surface of the cooktop.	<ul style="list-style-type: none"> <li>Remove using a ceramic-glass cooktop cleaning cream.</li> <li>Use cookware with clean, dry bottoms. Clean the cooktop with a ceramic cleaning agent regularly every week.</li> </ul>
"Cracking" or "popping" sound.	This is the sound of the metal heating and cooling during cooking.	This is normal operation, and not a system failure. Use the cooktop as usual.

## Information codes

Displayed code	Possible cause	Solution
C0	The top sensor is open when the burner is operating.	Turn off the cooktop and then restart. If the problem continues, unplug the power cord for 30 seconds or more and then reconnect. If the problem is not fixed, please contact a local Samsung service center.
	The top sensor is short when the burner is operating.	
C1	This code appears if the internal temperature of a burner rises abnormally high.	
C2	The IGBT sensor is open when the burner is operating.	
	The IGBT sensor is short when the burner is operating.	
d0	The key is pressed for more than 8 seconds.	
F0	Communications between main and sub PCBs failed.	Restart the appliance using the <b>POWER</b> button. If the problem continues, disconnect power for more than 30 seconds. Then, restart the appliance. If the problem still continues, contact a local Samsung service center.
F1	Communications between main and EEPROM failed.	
F2	The touch-enabled IC communicates abnormally.	
UP	The voltage is too high or low.	Check the power connection and make sure to turn the appliance on after regulating the voltage (208 V to 240 V).
A2	DC Motor Locking Information	It occurs when DC Motor cannot operate due to defects of PCB, wiring or blockage of on motor blade.

## Warranty (U.S.A)

**PLEASE DO NOT DISCARD. THE PAGE REPLACES THE WARRANTY PAGE IN THE USE & CARE GUIDE**

### SAMSUNG ELECTRIC COOKTOP

#### LIMITED WARRANTY TO ORIGINAL PURCHASER WITH PROOF OF PURCHASE

This SAMSUNG brand product, as supplied and distributed by SAMSUNG ELECTRONICS AMERICA INC. (SAMSUNG) and delivered new, in the original carton to the original consumer purchaser, is warranted by SAMSUNG against manufacturing defects in materials or workmanship for the limited warranty period, starting on the date of delivery to the original consumer purchaser, of:

#### One (1) Year Parts and Labor

This limited warranty is valid only on products purchased and used in the United States that have been installed, operated, and maintained according to the instructions attached to or furnished with the product. To receive warranty service, the purchaser must contact SAMSUNG at the address or phone number provided below for problem determination and service procedures. Warranty service can only be performed by a SAMSUNG authorized service center. The original dated bill of sale and/or proof of delivery must be presented upon request as proof of purchase to SAMSUNG or SAMSUNG's authorized service center to receive warranty service.

SAMSUNG will provide in-home service within the contiguous United States during the warranty period at no charge, subject to availability of SAMSUNG authorized servicers within the customer's geographic area. If in-home service is not available, SAMSUNG may elect, at its option, to provide transportation of the product to and from an authorized service center. If the product is located in an area where service by a SAMSUNG authorized servicer is not available, you may be responsible for a trip charge or required to bring the product to a SAMSUNG authorized service center for service.

To receive in-home service, product must be unobstructed and accessible to the service agent.

During the applicable warranty period, a product will be repaired, replaced, or the purchase price refunded, at the sole option of SAMSUNG. SAMSUNG may use new or reconditioned parts in repairing a product, or replace the product with a new or reconditioned product. Replacement parts and products are warranted for the remaining portion of the original product's warranty or ninety (90) days, whichever is longer. All replaced parts and products are the property of SAMSUNG and you must return them to SAMSUNG.

This limited warranty covers manufacturing defects in materials or workmanship encountered in normal household, noncommercial use of this product and shall not cover the following: damage that occurs in shipment, delivery, installation, and uses for which this product was not intended; damage caused by unauthorized modification or alteration of the product; product where the original factory serial numbers have been removed, defaced, changed in any way, or cannot be readily determined; cosmetic damage including scratches, dents, chips, and other damage to the product's finishes; damage caused by abuse, misuse, pest infestations, accident, fire, floods, or other acts of nature or God; damage caused by use of equipment, utilities, services, parts, supplies, accessories, applications, installations, repairs, external wiring or connectors not supplied or authorized by SAMSUNG; damage caused by incorrect electrical line current, voltage, fluctuations and surges; damage caused by failure to operate and maintain the product according to instructions; in-home instruction on how to use your product; and service to correct installation not in accordance with electrical or plumbing codes or correction of household electrical or plumbing (i.e., house wiring, fuses, or water inlet hoses). In addition, damage to the glass cooktop caused by (i) use of cleaners other than the recommended cleaners and pads or (ii) hardened spills of sugary materials or melted plastic that are not cleaned according to the directions in the use and care guide are not covered by this limited warranty.

The cost of repair or replacement under these excluded circumstances shall be the customer's responsibility.

Visits by an authorized servicer to explain product functions, maintenance or installation are not covered by this limited warranty. Please contact SAMSUNG at the number below for assistance with any of these issues.

#### **EXCLUSION OF IMPLIED WARRANTIES**

IMPLIED WARRANTIES, INCLUDING THE IMPLIED WARRANTIES OF MERCHANTABILITY OR FITNESS FOR A PARTICULAR PURPOSE, ARE LIMITED TO ONE YEAR OR THE SHORTEST PERIOD ALLOWED BY LAW. Some states do not allow limitations on how long an implied warranty lasts, so the above limitations or exclusions may not apply to you. This warranty gives you specific rights, and you may also have other rights, which vary from state to state.

#### **LIMITATION OF REMEDIES**

YOUR SOLE AND EXCLUSIVE REMEDY IS PRODUCT REPAIR, PRODUCT REPLACEMENT, OR REFUND OF THE PURCHASE PRICE AT SAMSUNG'S OPTION, AS PROVIDED IN THIS LIMITED WARRANTY. SAMSUNG SHALL NOT BE LIABLE FOR SPECIAL, INCIDENTAL OR CONSEQUENTIAL DAMAGES, INCLUDING BUT NOT LIMITED TO TIME WAY FROM WORK, HOTELS AND/OR RESTAURANT MEALS, REMODELING EXPENSES, LOSS OF REVENUE OR PROFITS, FAILURE TO REALIZE SAVINGS OR OTHER BENEFITS REGARDLESS OF THE LEGAL THEORY ON WHICH THE CLAIM IS BASED, AND EVEN IF SAMSUNG HAS BEEN ADVISED OF THE POSSIBILITY OF SUCH DAMAGES. Some states do not allow exclusion or limitation of incidental or consequential damages, so the above limitations or exclusions may not apply to you. This warranty gives you specific rights, and you may also have other rights, which vary from state to state.

SAMSUNG does not warrant uninterrupted or error-free operation of the product. No warranty or guarantee given by any other person, firm, or corporation with respect to this product shall be binding on SAMSUNG.

To obtain warranty service, please contact SAMSUNG at:

Samsung Electronics America, Inc.  
85 Challenger Road  
Ridgefield Park, NJ 07660  
1-800-SAMSUNG (726-7864) and [www.samsung.com/us/support](http://www.samsung.com/us/support)

#### **Registration**

Please register your product online at [www.samsung.com/register](http://www.samsung.com/register).

#### **Questions**

For questions about features, operation/performance, parts, accessories, or service, call 1-800-SAMSUNG (726-7864), or visit our Web site at [www.samsung.com/us/support](http://www.samsung.com/us/support).

Model # \_\_\_\_\_ Serial # \_\_\_\_\_

Please attach your receipt (or a copy) to this manual. You may need it, along with your model and serial number, when calling for assistance.

# Warranty (CANADA)

**PLEASE DO NOT DISCARD. THIS PAGE REPLACES THE WARRANTY PAGE IN  
THE USE & CARE GUIDE**

## **SAMSUNG ELECTRIC COOKTOP**

### **LIMITED WARRANTY TO ORIGINAL PURCHASER**

This SAMSUNG brand product, as supplied and distributed by SAMSUNG ELECTRONICS CANADA, INC. (SAMSUNG) and delivered new, in the original carton to the original consumer purchaser, is warranted by SAMSUNG against manufacturing defects in materials and workmanship for a limited warranty period of:

#### **One (1) Year Parts and Labor, Five (5) Years Parts Warranty For Glass Cooktop**

**During this limited additional four-years warranty, you will responsible for any  
labor or in-home service.**

This limited warranty begins on the original date of purchase, and is valid only on products purchased and used in the CANADA. To receive warranty service, the purchaser must contact SAMSUNG for problem determination and service procedures. Warranty service can only be performed by a SAMSUNG authorized service center. The original dated bill of sale must be presented upon request as proof of purchase to SAMSUNG or SAMSUNG's authorized service center. Samsung will provide in-home service during the warranty period at no charge subject to availability within the contiguous CANADA. In home service is not available in all areas. To receive in home service, the product must be unobstructed and accessible to the service agent. If service is not available Samsung may elect to provide transportation of the product to and from an authorized service center.

SAMSUNG will repair or replace this product, at our option and at no charge as stipulated herein, with new or reconditioned parts or products if found to be defective during the limited warranty period specified above. All replaced parts and products become the property of SAMSUNG and must be returned to SAMSUNG. Replacement parts and products assume the remaining original warranty, or ninety (90) days, whichever is longer. This limited warranty covers manufacturing defects in materials and workmanship encountered in normal, noncommercial use of this product and shall not apply to the following: damage which occurs in shipment; delivery and installation; applications and uses for which this product was not intended; altered product or serial numbers; cosmetic damage or exterior finish; accidents, abuse, neglect, fire, water, lightning or other acts of nature; use of products, equipment, systems, utilities, services, parts, supplies, accessories, applications, installations, repairs, external wiring or connectors not supplied or authorized by SAMSUNG which damage this product or result in service problems; incorrect electrical line voltage, fluctuations and surges; customer adjustments and failure to follow operating instructions, maintenance and environmental instructions that are covered and prescribed in the instruction book; product removal and reinstallation; problems caused by pest infestations, and overheating or overcooking by user. This limited warranty shall not cover cases of incorrect electric current, voltage or supply, light bulbs, house fuses, house wiring, cost of a service call for instructions, or fixing installation errors. Furthermore, damage to the glass cooktop caused by the use of cleaners other than the recommended cleaners and pads, damage to the glass cook top caused by hardened spills of sugary materials or melted plastic that are not cleaned according to the directions in the use and care guide are not covered. SAMSUNG does not warrant uninterrupted or error-free operation of the product.

## Appendix

EXCEPT AS SET FORTH HEREIN THERE ARE NO WARRANTIES ON THIS PRODUCT EITHER EXPRESS OR IMPLIED AND SAMSUNG DISCLAIMS ALL WARRANTIES INCLUDING, BUT NOT LIMITED TO, ANY IMPLIED WARRANTIES OF MERCHANTABILITY, INFRINGEMENT OR FITNESS FOR A PARTICULAR PURPOSE. NO WARRANTY OR GUARANTY GIVEN BY ANY PERSON, FIRM OR CORPORATION WITH RESPECT TO THIS PRODUCT SHALL BE BINDING ON SAMSUNG. SAMSUNG SHALL NOT BE LIABLE FOR LOSS OF REVENUE OR PROFITS, FAILURE TO REALIZE SAVINGS OR OTHER BENEFITS, OR ANY OTHER SPECIAL, INCIDENTAL OR CONSEQUENTIAL DAMAGES CAUSED BY THE USE, MISUSE OR INABILITY TO USE THIS PRODUCT, REGARDLESS OF THE LEGAL THEORY ON WHICH THE CLAIM IS BASED, AND EVEN IF SAMSUNG HAS BEEN ADVISED OF THE POSSIBILITY OF SUCH DAMAGES. NOR SHALL RECOVERY OF ANY KIND AGAINST SAMSUNG BE GREATER IN AMOUNT THAN THE PURCHASE PRICE OF THE PRODUCT SOLD BY SAMSUNG AND CAUSING THE ALLEGED DAMAGE. WITHOUT LIMITING THE FOREGOING, PURCHASER ASSUMES ALL RISK AND LIABILITY FOR LOSS, DAMAGE OR INJURY TO PURCHASER AND PURCHASER'S PROPERTY AND TO OTHERS AND THEIR PROPERTY ARISING OUT OF THE USE, MISUSE OR INABILITY TO USE THIS PRODUCT. THIS LIMITED WARRANTY SHALL NOT EXTEND TO ANYONE OTHER THAN THE ORIGINAL PURCHASER OF THIS PRODUCT, IS NONTRANSFERABLE AND STATES YOUR EXCLUSIVE REMEDY.

Some states do not allow limitations on how long an implied warranty lasts, or the exclusion or limitation of incidental or consequential damages, so the above limitations or exclusions may not apply to you. This warranty gives you specific legal rights, and you may also have other rights which vary from state to state.

To obtain warranty service, please contact SAMSUNG at:

**Samsung Electronics Canada Inc.**  
2050 Derry Road West, Mississauga, Ontario L5N 0B9 Canada  
1-800-SAMSUNG (726-7864) and [www.samsung.com/ca/support](http://www.samsung.com/ca/support) (English)  
[www.samsung.com/ca\\_fr/support](http://www.samsung.com/ca_fr/support) (French)

### Open source announcement

The software included in this product contains open source software. You may obtain the complete corresponding source code for a period of three years after the last shipment of this product by sending an email to <mailto:oss.request@samsung.com>.

It is also possible to obtain the complete corresponding source code in a physical medium such as a CD-ROM; a minimal charge will be required.

The following URL <http://opensource.samsung.com/opensource/SimpleConnectTP/seq/0> leads to the download page of the source code made available and open source license information as related to this product. This offer is valid to anyone in receipt of this information.



# Appendix

---

## Model name & serial number

---

Both the model name and the serial number are labeled underneath the cooktop base.

For later use, write down the information onto the current page.

Model Name \_\_\_\_\_

Serial Number \_\_\_\_\_

**Memo**

---



Scan this with your smartphone

Scan the QR code\* or visit  
[www.samsung.com/spsn](http://www.samsung.com/spsn)  
to view our helpful  
How-to Videos and Live Shows

\* Requires reader to be installed on your  
smartphone

Please be advised that the Samsung warranty does NOT cover service calls to explain product operation, correct improper installation, or perform normal cleaning or maintenance.

#### QUESTIONS OR COMMENTS?

COUNTRY	CALL	OR VISIT US ONLINE AT
U.S.A Consumer Electronics	1-800-SAMSUNG (726-7864)	<a href="http://www.samsung.com/us/support">www.samsung.com/us/support</a>
CANADA	1-800-SAMSUNG (726-7864)	<a href="http://www.samsung.com/ca/support">www.samsung.com/ca/support</a> (English) <a href="http://www.samsung.com/ca_fr/support">www.samsung.com/ca_fr/support</a> (French)

