

Oven with microwave

User manual

NQ70*5***D*



SAMSUNG

Regulatory Notice

PRECAUTIONS TO AVOID POSSIBLE EXPOSURE TO EXCESSIVE MICROWAVE ENERGY

- A. Do not attempt to operate this microwave oven with the door open since open-door operation can result in harmful exposure to microwave energy. It is important not to defeat or tamper with the safety interlocks.
- B. Do not place any object between the oven front face and the door or allow soil or cleaner residue to accumulate on the sealing surface.
- C. Do not operate the microwave oven if it is damaged. It is particularly important that the oven door close properly and that there is no damage to the:
 - 1) Door (bent),
 - 2) Hinges and latches, (broken or loosened),
 - 3) Door seals and sealing surface.
- D. The microwave oven should not be adjusted or repaired by anyone except properly qualified service personnel.

1. FCC NOTICE

FCC STATEMENT

This equipment generates and uses ISM frequency energy and if not installed and used properly, that is in strict accordance with the manufacturer's instructions, may cause interference to radio and television reception. It has been type tested and found to comply with limits for ISM Equipment pursuant to part 18 of FCC Rules, which are designed to part 18 of FCC Rules, which are designed to provide residential installation.

However, there is no guarantee that interference will not occur in a particular installation. If this equipment does cause interference to radio or television reception, which can be determined by turning the equipment off and on, the user is encouraged to try to correct the interference by one or more of the following:

- Reorient the receiving antenna of the radio or television.
- Relocate the Microwave Oven with respect to the receiver.
- Move the microwave oven away from the receiver.
- Plug the microwave oven into a different outlet so that the microwave oven and the receiver are on different branch codes.

The manufacturer is not responsible for any radio or TV interference caused by unauthorized modification to this microwave oven. It is the responsibility of the user to correct such interference.

This equipment has been tested and found to comply with the limits for a Class B digital device, pursuant to part 15 of the FCC Rules. These limits are designed to provide reasonable protection against harmful interference in a residential installation. This equipment generates, uses and can radiate radio frequency energy and, if not installed and used in accordance with the instructions, may cause harmful interference to radio communications. However, there is no guarantee that interference will not occur in a particular installation. If this equipment does cause harmful interference to radio or television reception, which can be determined by turning the equipment off and on, the user is encouraged to try to correct the interference by one or more of the following measures:

- Reorient or relocate the receiving antenna.
- Increase the separation between the equipment and receiver.
- Connect the equipment into an outlet on a circuit different from that to which the receiver is connected.
- Consult the dealer or an experienced radio/TV technician for help.

To satisfy FCC RF exposure requirements, a separation distance of 20 cm or more should be maintained between the antenna of this device and persons during device operation.

To ensure compliance, operations at closer than this distance is not recommended.

WARNING : Any changes or modifications to this unit not expressly approved by the party responsible for compliance could void the user's authority to operate the equipment.

2. IC Notice

The term "IC" before the radio certification number only signifies that Industry Canada technical specifications were met. Operation is subject to the following two conditions: (1) this device may not cause interference, and (2) this device must accept any interference, including interference that may cause undesired operation of the device.

This Class B digital apparatus complies with Canadian ICES-003. For products available in the US/Canadian markets, only channels 1~11 are available. You cannot select any other channels.

IC RADIATION EXPOSURE STATEMENT:

This equipment complies with IC RSS-102 radiation exposure limits set forth for an uncontrolled environment. This equipment should be installed and operated so there is at least 8 inches (20 cm) between the radiator and your body. This device and its antenna(s) must not be co-located or operated in conjunction with any other antenna or transmitter.

Contents

Important safety instructions	4
What you need to know about safety instructions	4
California Proposition 65 Warning	5
Grounding Instructions	6
Use Of Extension Cords	7
For your safety	7
Electrical Safety	9
Child Safety	10
Oven	10
Self-cleaning ovens	11
Critical installation warnings	12
Critical usage warning	13
Usage cautions	16
Critical cleaning warnings	18
Introducing your new oven	19
Overview	19
What's included with your oven	19
Before you begin	20
Energy saving tips	20
Turntable (For microwave oven)	20
Basic operations	21
Control panel	21
Setting the clock	22
Setting the kitchen timer	22
Control Lockout	23
Setting the power level	23
Timed Cooking	23
Minimum and maximum settings	24
Microwave Oven (Upper Oven)	24
Microwave	24
Broil	25
Popcorn	25
Defrost	26

Sensor Cook	27
Auto Cook	30
Soften/Melt	32
Oven (Lower Oven)	33
Timed Cooking	33
Delay Start	34
Turning the light on and off	34
Using the oven racks	34
Baking	36
Broiling	36
Using Bread Proof	37
Using Keep Warm	37
Using Settings	38
Using the Sabbath feature	40
Using Smart Control (Lower oven only)	41
Maintaining your appliance	42
Self-cleaning (Lower oven only)	42
Wall Oven Steam Clean	44
Care and cleaning of the oven	45
Removing the oven door (Lower oven only)	46
Replacing the oven door (Lower oven only)	47
Changing the oven light (Lower oven only)	48
Troubleshooting	49
Control Display	49
For the Microwave Oven	49
For the Lower Oven	52
Information codes	54
Warranty (USA)	55
SAMSUNG MICROWAVE OVEN	55
Warranty (CANADA)	57
Appendix	58
Open Source Announcement	58

Important safety instructions

Read and follow all instructions before using your oven to prevent the risk of fire, electric shock, personal injury, or damage when using the oven. This guide does not cover all possible conditions that may occur. Always contact your service agent or the manufacturer about problems that you do not understand.

WHAT YOU NEED TO KNOW ABOUT SAFETY INSTRUCTIONS

Warnings and important safety instructions in this manual do not cover all possible conditions and situations that may occur. It is your responsibility to use common sense, caution, and care when installing, maintaining, and operating your oven.

SAVE THESE INSTRUCTIONS

Important safety symbols and precautions

What the icons and signs in this user manual mean:

WARNING

Hazards or unsafe practices that may result in **severe personal injury or death**.









CAUTION

Hazards or unsafe practices that may result in **minor personal injury or property damage**.

CAUTION

To reduce the risk of fire, explosion, electric shock, or personal injury when using your oven, follow these basic safety precautions.

SAVE THESE INSTRUCTIONS

-  Do NOT attempt.
-  Do NOT disassemble.
-  Do NOT touch.
-  Follow directions explicitly.
-  Unplug the power plug from the wall socket.
-  Make sure the machine is grounded to prevent electric shock.
-  Call a Samsung service center for help.
-  Note

These warning signs are here to prevent injury to you and others. Please follow them explicitly.

After reading this section, keep it in a safe place for future reference.

CALIFORNIA PROPOSITION 65 WARNING

WARNING

Cancer and Reproductive Harm - www.P65Warnings.ca.gov.

Important safety instructions (Microwave Oven)

WARNING

To reduce risk of burns, electric shock, fire, personal injury or exposure to excessive microwave energy:

1. Read all safety instructions before using the appliance.
2. Read and follow the specific "Precautions to avoid possible exposure to excessive microwave energy" on page 2.
3. This appliance must be grounded. Connect only to properly grounded outlets. See Important "Grounding instructions" on page 6 of this manual.
4. Install or locate this appliance only in accordance with the provided installation instructions.
5. Some products such as whole eggs and sealed containers (for example, closed glass jars) can explode if heated rapidly. Never heat them in a microwave oven.
6. Do not use this appliance for other purposes than cooking. Drying of clothing and heating of warming pads, slippers, sponges, damp cloth and similar may lead to risk of injury, ignition or fire. Use this appliance only for its intended use as described in the manual. Do not put corrosive chemicals or vapors in or on this appliance. This type of oven is specifically designed to heat, cook, or dry food. It is not designed for industrial or laboratory use.
7. As with any appliance, close supervision is necessary when it is used by children. Keep children away from the door when opening or closing it as they may bump themselves on the door or catch their fingers in the door.
8. Do not operate this appliance if it has a damaged cord or plug, if it is not working properly, or if it has been damaged or dropped.
9. This appliance should be repaired or serviced only by qualified service personnel. Contact the nearest authorized service facility for examination, repair, or adjustment.
10. Do not cover or block any openings in the appliance.
11. Do not tamper with or make any adjustments or repairs to the door.
12. Do not store this appliance outdoors. Do not use this product near water, for example, near a kitchen sink, in a wet basement, near a swimming pool, or similar locations.

Important safety instructions (Microwave Oven)

13. Do not immerse the cord or plug in water.
14. Keep the cord away from heated surfaces (including the back of the oven).
15. Do not let the cord hang over edge of a table or counter.
16. When cleaning surfaces of the door and oven that come together when the door closes, use only mild, nonabrasive soaps, or detergents applied with a sponge or soft cloth. Unplug the plug before cleaning the unit.
17. To reduce the risk of fire in the oven cavity:
 - Do not overcook food. Carefully attend the appliance when paper, plastic, or other combustible materials are placed inside the oven to facilitate cooking.
 - Remove wire twist-ties from paper or plastic bags before placing the bags in the oven.
18. If materials inside the oven ignite, keep the oven door closed, turn the oven off, and disconnect the power cord, or shut off the power at the fuse or circuit breaker panel. If the door is opened, the fire may spread.
19. Do not use the cavity for storage purposes. Do not leave paper products, cooking utensils, or food in the cavity when not in use.
20. Liquids, such as water, milk, coffee, or tea can be overheated beyond the boiling point without appearing to be boiling. Visible bubbling or boiling when the container is removed from the microwave oven is not always present. THIS COULD RESULT IN VERY HOT LIQUIDS SUDDENLY BOILING OVER WHEN THE CONTAINER IS DISTURBED OR A SPOON OR OTHER UTENSIL IS INSERTED INTO THE LIQUID. To reduce the risk of injury:
 - Do not overheat liquid.
 - Stir liquid both before and halfway through heating it.
 - Do not use straight-sided containers with narrow necks.
 - After heating, let containers with liquid stand in the microwave oven for a short time before removing.
 - Use extreme care when inserting a spoon or other utensil into a container holding liquid.

21. Oversized foods or oversized metal utensils should not be inserted into the microwave oven as they may create a risk of fire or electric shock.
22. Do not clean with metal scouring pads. Pieces can burn off the pad and touch electrical parts creating a risk of electric shock.
23. Do not store any materials, other than manufacturer's recommended accessories, in this microwave when not in use.
24. Do not cover the racks or any other part of the microwave oven with metal foil. This will cause overheating of the microwave.

GROUNDING INSTRUCTIONS

This appliance must be grounded. In the event of an electrical short circuit, grounding reduces the risk of electric shock by providing an escape wire for the electrical current. This appliance is equipped with a cord that includes a grounding wire and a grounding plug. The plug must be plugged into an outlet that is properly installed and grounded.

WARNING

Improper use of the grounding plug can result in a risk of electric shock.

- Plug into a grounded 3 prong outlet. Do not remove the third (grounding) prong. Do not use an adaptor or otherwise defeat the grounding plug.
- Consult a qualified electrician or service person if you do not understand the grounding instructions or if you are not sure if the appliance is properly grounded.
- We do not recommend using an extension cord with this appliance. If the power-supply cord is too short, have a qualified electrician or serviceman install an outlet near the appliance. However, if it is necessary to use an extension cord, read and follow the "Use of Extension Cords" section below.

SAVE THESE INSTRUCTIONS

SAVE THESE INSTRUCTIONS

USE OF EXTENSION CORDS

A short power-supply cord is provided to reduce the risk of your becoming entangled in or tripping over a longer cord. Longer cord sets or extension cords are available and you can use them if you exercise care. If you use a long cord or extension cord:

1. The marked electrical rating of the cord set or extension cord should be at least as great as the electrical rating of the appliance.
2. The extension cord must be a grounding-type 3-wire cord and it must be plugged into a 3-slot outlet.
3. The longer cord should be arranged so that it will not drape over the counter top or tabletop where it can be pulled on by children or tripped over accidentally. If you use an extension cord, the interior light may flicker and the speed of the blower may vary when the microwave oven is on. Cooking times may be longer too.

SAVE THESE INSTRUCTIONS

Important safety instructions (Oven)

FOR YOUR SAFETY

When using electrical appliances, you should follow basic safety precautions, including the following:

 **CAUTION**

- Use this appliance only for its intended purpose as described in this Owner's Manual.
- Potentially hot surfaces include the oven vent opening, surfaces near the opening, and crevices around the oven door.



Proper Installation - Be sure your appliance is properly installed and grounded by a qualified technician.



User servicing - Do not repair or replace any part of the appliance unless specifically recommended in this manual. All other servicing should be referred to a qualified technician.



Always disconnect the power to the appliance before servicing by removing the fuse or switching off the circuit breaker.

SAVE THESE INSTRUCTIONS

Important safety instructions (Oven)

- ☒ • **Do not enter the oven.**
 - **Do not leave children alone.** Never leave children alone or unattended in an area where this appliance is in use. They should never be allowed to sit or stand on any part of the appliance.
 - **Never use your appliance for warming or heating the room.**
 - **Do not use water on grease fires.** Turn off the oven to avoid spreading the flames. Smother the fire or flames by closing the door or use a dry chemical, baking soda, or foam-type extinguisher.
 - Avoid scratching or striking the glass doors and the control panel. Doing so may lead to glass breakage. Do not cook on a product with broken glass. Shock, fire, or cuts may occur.
-
- ☒ • If there is a fire in the oven during self-cleaning, turn the oven off and wait for the fire to go out. Do not force the door open. The introduction of fresh air at self-cleaning temperatures may lead to a burst of flame from the oven. Failure to follow these instructions may result in severe burns.
 - If the oven is heavily soiled with oil, self-clean the oven before using the oven again. Leaving the oil in place creates a risk of fire.
 - Wipe up heavy soil on the oven bottom with a paper towel or rag before self-cleaning. Self-cleaning the oven when there is heavy soil on the oven bottom requires longer cleaning cycles and produces more smoke.
 - ★ • **Storage in or on the appliance.** Do not store flammable materials in the oven or near the surface units. Be sure all packing materials are removed from the appliance before operating it. Keep plastics, clothes, and paper away from parts of the appliance that may become hot.
 - **Wear proper apparel.** Never wear loose-fitting or hanging garments while using the appliance.

SAVE THESE INSTRUCTIONS

SAVE THESE INSTRUCTIONS

-
- ★ • **Use only dry potholders.** Placing moist or damp potholders on hot surfaces may result in burns from steam. Do not let the potholder touch hot heating elements. Do not use a towel or other bulky cloth instead of a potholder.
 - Teach children not to play with the controls or any other part of the oven.
 - For your safety, do not use high-pressure water cleaners or steam jet cleaners to clean any part of the oven.
 - If the power cord is damaged, it must be replaced by the manufacturer, its service agent, or similarly qualified persons to avoid creating a hazard.
 - The appliance is not intended for use by persons (including children) with reduced physical, sensory or mental capabilities, or lack of experience and knowledge, unless they have been given supervision or instruction concerning use of the appliance by a person responsible for their safety.

SAVE THESE INSTRUCTIONS

ELECTRICAL SAFETY

- ★ • Use only the factory installed flexible power cord to connect to the power supply. Do not use a 3rd party power supply cord kit.
- The appliance should be serviced only by qualified service personnel. Repairs carried out by unqualified individuals may cause injury or a serious malfunction. If your appliance is in need of repair, contact a Samsung authorized service center. Failure to follow these instructions may result in damage and void the warranty.
- Flush - mounted appliances may be operated only after they have been installed in cabinets and workplaces that conform to the relevant standards. This ensures that the appliances are installed in compliance with the appropriate safety standards.
- If your appliance malfunctions or if fractures, cracks, or splits appear:
 - Switch off the oven.
 - Unplug the oven from the AC wall outlet.
 - Contact your local Samsung service center.

SAVE THESE INSTRUCTIONS

Important safety instructions (Oven)

WARNING

Ensure that the appliance is switched off before replacing the lamp to avoid the possibility of electric shock.

CHILD SAFETY

WARNING

- This appliance is not intended for use by young children or infirm persons without the adequate supervision of a responsible adult.
- Young children should be supervised to ensure that they do not play with the appliance.
- Keep children away from the door when opening or closing it as they may bump themselves on the door or catch their fingers in the door.
- During self-cleaning, the surfaces may get hotter than usual. Keep small children away from the oven when it is in the self-cleaning mode.

WARNING

Accessible parts may become hot during use. To avoid burns, young children should be kept away.

SAVE THESE INSTRUCTIONS

OVEN

-  **DO NOT TOUCH THE HEATING ELEMENTS OR INTERIOR SURFACES OF THE OVEN.** Heating elements may be hot even though they are dark in color. Interior surfaces of an oven become hot enough to cause burns. During and after use, do not touch or let clothing or other flammable materials contact the heating elements or interior surfaces of the oven until they have had sufficient time to cool. Other surfaces of the appliance may become hot enough to cause burns. Among these surfaces are oven vent openings and surfaces near these openings, the oven door, and the window of the oven door.
- **Do not heat unopened food containers.** The build-up of pressure may cause the container to burst and result in injury.
- **Do not use the oven to dry newspapers.** If overheated, newspapers can catch fire.
- **Do not use the oven for a storage area.** Items stored in an oven can ignite.

SAVE THESE INSTRUCTIONS

-
- ★ • **Use care when opening the door.** Let hot air or steam escape before you remove food from or put food into the oven.
 - **Protective liners.** Do not use aluminum foil to line the oven bottoms, except as suggested in this manual. Improper installation of these liners may result in a risk of electric shock or fire.
 - **Placement of oven racks.** Always place oven racks in the desired location while the oven is cool. If the rack must be moved while the oven is hot, use potholders. Do not let the potholders come in contact with the hot heating element in the oven.
 - ☐ • Do not allow aluminum foil or a meat probe to contact the heating elements.
 - **During use, the appliance becomes hot.** Care should be taken to avoid touching heating elements inside the oven.
 - Do not use harsh abrasive cleaners or sharp metal scrapers to clean the oven door glass. They can scratch the surface which may result in the glass shattering.

SAVE THESE INSTRUCTIONS

⚠ CAUTION

Do not attempt to operate the oven during a power failure. If the power fails, always turn the oven off. If the oven is not turned off and the power returns, the oven may begin to operate again. Food left unattended could catch fire or spoil.

SELF-CLEANING OVENS

- ☐ • **Do not clean the door gasket.** The door gasket is essential for a good seal. Care should be taken not to rub, damage, or move the gasket.
- ★ • **Never keep pet birds in the kitchen.** Birds are extremely sensitive to the fumes released during an oven self-clean cycle. Fumes may be harmful or fatal to birds. Move birds to a well-ventilated room.
- **Clean only the parts listed in this manual in the self-clean cycle.** Before self-cleaning the oven, remove the partition, racks, utensils, and any food.

SAVE THESE INSTRUCTIONS

Important safety instructions (Oven)

- ★ • Before operating the self-clean cycle, wipe grease and food soils from the oven. Excessive amounts of grease may ignite, leading to smoke damage to your home.
- Do not use any commercial oven cleaner or oven liner protective coating of any kind in or on the outside of the oven.
- Remove the nickel oven shelves from the oven before you begin the self-cleaning cycle or they may discolor.
- Opening a window or turning on a ventilation fan or hood is recommended during and after self-cleaning.
- If the self-cleaning mode malfunctions, turn the oven off and disconnect the power supply. Have it serviced by a qualified technician.
- Excess spillage must be removed before you run the self-cleaning cycle.



SAVE THESE INSTRUCTIONS

CRITICAL INSTALLATION WARNINGS

WARNING

- ★ • This appliance must be installed by a qualified technician or service company.
 - Failing to have a qualified technician install the oven may result in electric shock, fire, an explosion, problems with the product, or injury.
- Unpack the oven, remove all packaging material and examine the oven for any damage such as dents on the interior or exterior of the oven, broken door latches, cracks in the door, or a door that is not lined up correctly. If there is any damage, do not operate the oven and notify your dealer immediately.
- Keep all packaging materials out of the reach of children. Children may use them for play and injure themselves.
-  • This appliance must be properly grounded.
- Do not ground the appliance to a gas pipe, plastic water pipe, or telephone line.
 - This may result in electric shock, fire, an explosion, or problems with the product

SAVE THESE INSTRUCTIONS

-
-  • Do not cut or remove the ground prong from the power cord under any circumstances.
 - Connect the oven to a circuit that provides the correct amperage.
 -  • Do not install this appliance in a humid, oily or dusty location, or in a location exposed to direct sunlight or water (rain drops).
 - This may result in electric shock or fire.
 - Do not use a damaged power cord or loose wall socket.
 - This may result in electric shock or fire.
 - Do not pull or excessively bend the power cord.
 - Do not twist or tie the power cord.
 - Do not hook the power cord over a metal object, place a heavy object on the power cord, or insert the power cord between objects.
 - This may result in electric shock or fire.
 -  If the power cord is damaged, contact your nearest Samsung service center.

SAVE THESE INSTRUCTIONS

CRITICAL USAGE WARNING

CAUTION

-  • If the appliance is flooded by any liquid, please contact your nearest Samsung service center. Failing to do so may result in electric shock or fire.
- If the appliance produces a strange noise, a burning smell, or smoke, unplug the power plug immediately and contact your nearest Samsung service center.
 - Failing to do so may result in electric shock or fire
- In the event of a gas leak (such as propane gas, LP gas, etc.), ventilate the area immediately. Do not touch the power cord. Do not touch the appliance.
 - A spark may result in an explosion or fire.
- Take care not to contact the oven door, heating elements, or any of the other hot parts with your body while cooking or just after cooking.
 - Failing to do so may result in burns.

SAVE THESE INSTRUCTIONS

Important safety instructions (Oven)

- ★ • If materials inside the oven should ignite, keep the oven door closed, turn the oven off and disconnect the power cord, or shut off power at the fuse or circuit breaker panel. If the door is opened, the fire may spread.
 - Always observe safety precautions when using your oven. Never try to repair the oven on your own - there is dangerous voltage inside. If the oven needs to be repaired, contact an authorized Samsung service center near you.
 - If you use the appliance when it is contaminated by foreign substances such as food waste, it may result in a problem with the appliance.
 - Take care when removing the wrapping from food taken out of the oven.
 - If the food is hot, hot steam may be emitted abruptly when you remove the wrapping and this may result in burns.
 - ☒ • Do not attempt to repair, disassemble, or modify the appliance yourself.
 - Since a high voltage current enters the product chassis, it may result in electric shock or fire.
 - When a repair is needed, contact your nearest Samsung service center.
-
- ☒ • If any foreign substance such as water has entered the appliance, contact your nearest Samsung service center.
 - Failing to do so may result in electric shock or fire.
 - ☒ • Do not touch the power cord with wet hands.
 - This may result in electric shock.
 - Do not turn the appliance off while an operation is in progress.
 - This may cause a spark and result in electric shock or fire.
 - Do not let children or any person with reduced physical, sensory, or mental capabilities use this appliance unsupervised.

SAVE THESE INSTRUCTIONS

SAVE THESE INSTRUCTIONS

-
- ☒ • Make sure that the appliance's controls and cooking areas are out of the reach of children.
 - Failing to do so may result in electric shock, burns, or injury.
 - Do not touch the inside of the appliance immediately after cooking. The inside of the appliance will be hot.
 - Failing to do so may result in burns.
 - Do not use or place flammable sprays or objects near the oven.
 - Flammable items or sprays can cause fires or an explosion.
 - Do not insert fingers, foreign substances, or metal objects such as pins or needles into inlets, outlets, or holes. If foreign substances are inserted into any of these holes, contact your product provider or nearest Samsung service center.

SAVE THESE INSTRUCTIONS

-
- ☒ • Do not tamper with or make any adjustments or repairs to the door. Under no circumstances should you remove the door or outer shell of the oven.
 - Do not store or use the oven outdoors.
 - Never use this appliance for purposes other than cooking.
 - Using the appliance for any purpose other than cooking may result in fire.
 - Open the cap or stopper of sealed containers (herb tonic tea bottle, baby bottle, milk bottle and so on) before heating them. Make a hole in food items that have shells (eggs, chestnuts, etc.) with a knife before cooking them.
 - Failing to do so may result in burns or injury.
 - Never heat plastic or paper containers and do not use them for cooking.
 - Failing to do so may result in fire.
 - Do not heat food wrapped in paper from magazines, newspapers, etc.
 - This may result in fire.

SAVE THESE INSTRUCTIONS

Important safety instructions (Oven)

- ☒ • Do not open the door when the food in the oven is burning.
 - If you open the door, it causes an inflow of oxygen and may cause the food to ignite.
- Do not apply excessive pressure to the door or the inside of the appliance. Do not strike the door or the inside or the appliance.
 - Hanging on to the door may result in the product falling and cause serious injury.
 - If the door is damaged, do not use the appliance. Contact a Samsung service center.
- Do not hold food in your bare hands during or immediately after cooking.
 - Use cooking gloves. The food may be very hot and you could burn yourself.
 - As the handle and oven surfaces may be hot enough to cause burns after cooking, use cooking gloves to protect your hands from burns.

SAVE THESE INSTRUCTIONS

USAGE CAUTIONS

CAUTION

- ★ • If the surface is cracked, turn the appliance off.
 - Failing to do so may result in electric shock.
- Dishes and containers can become hot. Handle with care.
- Hot foods and steam can cause burns. Carefully remove container coverings, directing the steam away your hands and face.
- Remove lids from baby food jars before heating. After heating baby food, stir well to distribute the heat evenly. Always test the temperature by tasting before feeding the baby. The glass jar or the surface of the food may appear to be cooler than the interior, which can be hot enough to burn an infant's mouth.
- Take care as beverages or food may be very hot after heating.
 - Especially when feeding a child, make sure the food or beverage has cooled sufficiently.

SAVE THESE INSTRUCTIONS

-
- ★ • Take care when heating liquids such as water or other beverages.
 - Make sure to stir during or after cooking.
 - Avoid using a slippery container with a narrow neck.
 - Wait at least 30 seconds after heating before removing the heated liquid.
 - Failing to do so may result in an abrupt overflow of the contents and cause burns.
 - ☒ • Do not stand on top of the appliance or place objects (such as laundry, an oven cover, lighted candles, lighted cigarettes, dishes, chemicals, metal objects, etc.) on the appliance.
 - Items, such as a cloth, may get caught in the door.
 - This may result in electric shock, fire, problems with the product, or injury.
 - Do not operate the appliance with wet hands.
 - This may result in electric shock.
 - Do not spray volatile substances such as insecticide onto the surface of the appliance.
 - As well as being harmful to humans, it may also result in electric shock, fire, or problems with the product.

SAVE THESE INSTRUCTIONS

-
- ☒ • Do not put your face or body close to the appliance while cooking or when opening the door just after cooking.
 - Take care that children do not come too close to the appliance.
 - Failing to do so may result in children burning themselves.
 - Do not place food or heavy objects over the edge of the oven door.
 - If you open the door, the food or object may fall and this may result in burns or injury.
 - Do not abruptly cool the door, the inside of the appliance, or a dish by pouring water over it during or just after cooking.
 - This may result in damage to the appliance. The steam or water spray may result in burns or injury.
 - Do not operate while empty except for self-cleaning.
 - Do not defrost frozen beverages in narrow-necked bottles. The bottles can break.

SAVE THESE INSTRUCTIONS

Important safety instructions (Oven)

- ☒ • Do not scratch the glass of the oven door with a sharp object.
 - This may result in the glass being damaged or broken.
- Do not store anything directly on top of the oven when it is in operation.
- Do not use sealed containers. Remove seals and lids before cooking. Sealed containers can explode due to the build up of pressure even after the oven has been turned off.
- Take care that food you are cooking in the oven does not come into contact with the heating element.
 - This may result in fire.
- Do not over-heat food.
 - Overheating food may result in fire.
- Use caution when opening or closing the door. Your fingers may be pinched, resulting in physical injury.

CRITICAL CLEANING WARNINGS

⚠ CAUTION

- ★ • Do not clean the appliance by spraying water directly on to it.
- Do not use benzene, thinner, or alcohol to clean the appliance.
 - This may result in discoloration, deformation, damage, electric shock, or fire.
- Take care not to hurt yourself when cleaning the appliance (externally or internally).
 - You may hurt yourself on the sharp edges of the appliance.
- Do not clean the appliance with a steam cleaner.
 - This may result in corrosion.
- Keep the inside of the oven clean. Food particles or spattered oils stuck to the oven walls or floor can cause paint damage and reduce the efficiency of the oven.

SAVE THESE INSTRUCTIONS

SAVE THESE INSTRUCTIONS

Introducing your new oven

Overview

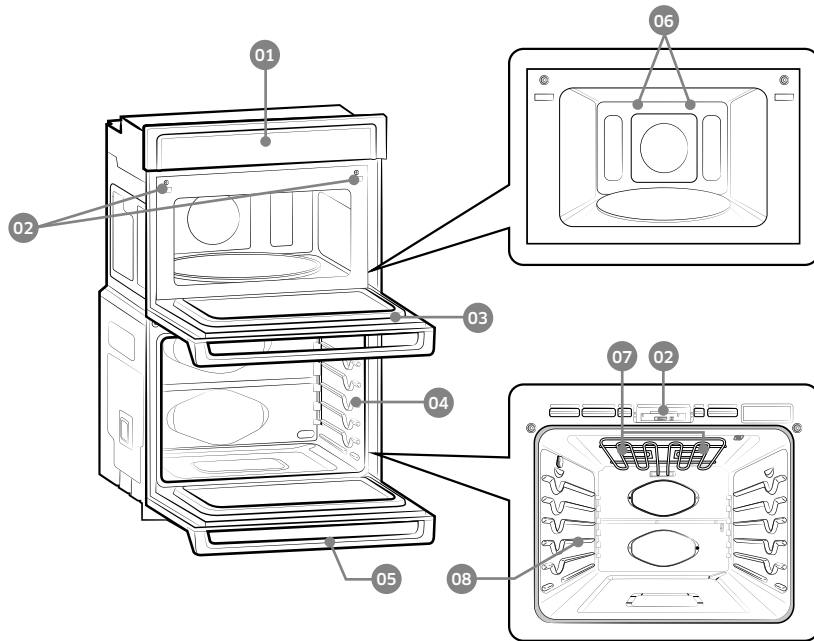

- | | | |
|-------------------|-------------------|-----------------|
| 01 Control panel | 02 Door latch | 03 MWO door |
| 04 Oven gasket | 05 Oven door | 06 Halogen lamp |
| 07 Halogen lamp * | 08 Shelf position | |

What's included with your oven

This oven ships with different kinds of accessories that help you cook what you want.

Accessories for oven

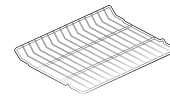

Wire racks (2) *

Wire racks	Use these racks in the oven when baking and broiling.
------------	---

Introducing your new oven

Accessories for microwave



Roller ring *



Turntable *

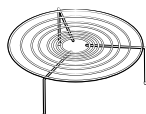

Rack *

Roller ring	Put in the center of the base. It supports the turntable.
Turntable	Put on the roller ring with the center fitting of the coupler. It serves as a cooking base.
Rack	Use this rack as appropriate to cook two dishes simultaneously. You can put a smaller dish on the turntable, and the other dish on the rack. You can also use this rack with the Broil function. NOTE Do not use wire racks with Microwave mode except where specifically noted in this manual.

NOTE

- Do not use the turntable without the roller ring.
- If you need an accessory marked with a *, you can buy it from the Samsung Contact Center (1-800-SAMSUNG (726-7864)).

Before you begin

Before using the top and bottom ovens for the first time, remove all the accessories, and then clean the ovens thoroughly. Then, set the lower oven to Bake, and run it at 400 °F for 1 hour. Next, set the microwave (top) oven to Broil for 1 hour. There will be a distinctive odor. This is normal. Ensure your kitchen is well ventilated during this conditioning period.

Energy saving tips

- During cooking, the oven door should remain closed except when you turn food over.
Do not open the door frequently during cooking to maintain the oven temperature and to save energy.
- If cooking time is more than 30 minutes, you can switch the oven off 5-10 minutes before the end of the cooking time to save energy. The residual heat will complete the cooking process.
- To save energy and reduce the time needed for re-heating the oven, plan oven use to avoid turning the oven off between cooking one item and the next.
- Whenever possible, cook more than one item at a time.

Turntable (For microwave oven)

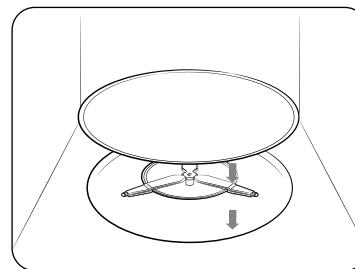

Remove all packing materials inside the oven. Install the roller ring and turntable. Check that the turntable rotates freely.

Basic operations

Control panel

READ THE INSTRUCTIONS CAREFULLY BEFORE USING THE OVEN. For satisfactory use of your oven, become familiar with the various features and functions of the oven as described below. **Detailed instructions for each feature and function follow later in this user manual.**

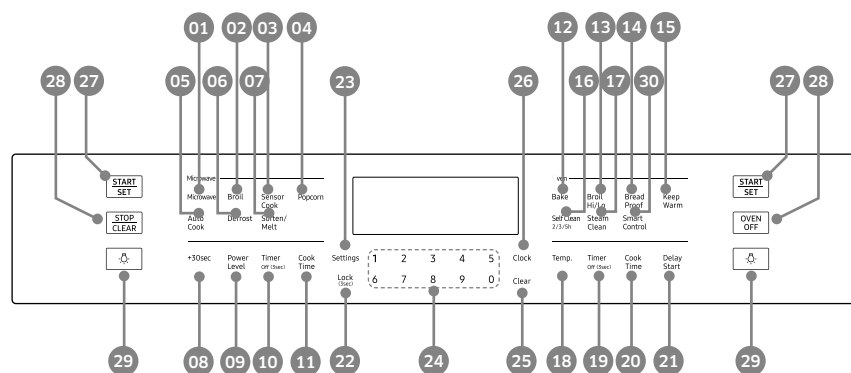

- 01 **Microwave:** Use to select the Microwave function.
- 02 **Broil:** Use to select the Broil function.
- 03 **Sensor Cook:** Use to select the Sensor Cook function.
- 04 **Popcorn:** Use to select the Popcorn function.
- 05 **Auto Cook:** Use to select the Auto Cook function.
- 06 **Defrost:** Use to select the Defrost function.
- 07 **Soften/Melt:** Use to select the Soften/Melt function.
- 08 **+30sec:** Press to add operation time during Microwave, Broil, Speed Broil mode.
- 09 **Power Level:** Use to change the Microwave power level.
- 10 **Timer Off (3sec):** Use to set or cancel the kitchen timer. The kitchen timer does not start or stop cooking (upper microwave oven).
- 11 **Cook Time:** Touch and then use the number pad to set the amount of time you want your food to cook. The oven will shut off when the cooking time has run out (upper microwave oven).

- 12 **Bake:** Use to select the Bake function.
- 13 **Broil Hi/Lo:** Use to select the Broil function.
- 14 **Bread Proof:** Use to select the Bread Proof function.
- 15 **Keep Warm:** Use to select the Keep Warm function to keep cooked foods warm.
- 16 **Self Clean 2/3/5h:** Use to select the Self-cleaning function.
- 17 **Steam Clean:** Use to select the steam cleaning function of the oven.
- 18 **Temp.:** Use to change the temperature when the oven is operating (lower oven).
- 19 **Timer Off (3sec):** Use to set or cancel the kitchen timer. The kitchen timer does not start or stop cooking (lower oven).
- 20 **Cook Time:** Touch and then use the number pad to set the amount of time you want your food to cook. The oven will shut off when the cooking time has run out (lower oven).
- 21 **Delay Start:** Use to set the oven to start and stop automatically at a time you set.
- 22 **Lock (3sec):** Use to disable all oven functions.
- 23 **Settings:** Use to bring up the User Preference menu in the display.
- 24 **Number Pad:** Use to set any function requiring numbers such as the time of day on the clock, the timer, the oven temperature, the start time, and the length of operation for timed cooking, etc.
- 25 **Clear:** Use to cancel a previously entered temperature or time.
- 26 **Clock:** Use to set the time of day.
- 27 **START/SET:** Use to start any cooking or cleaning function in the oven.
- 28 **STOP/CLEAR / OVEN OFF:** Use to cancel all oven operations except the clock and timer.
- 29 **Lamp:** Use to turn the oven light on or off.
- 30 **Smart Control:** Use to select the Smart Control feature.

Basic operations

Oven or Microwave Oven

The Combi Oven provides two operation modes: Oven and Microwave Oven. To select either Oven and Microwave Oven, touch the desired operation mode. Then, the control panel will be activated.

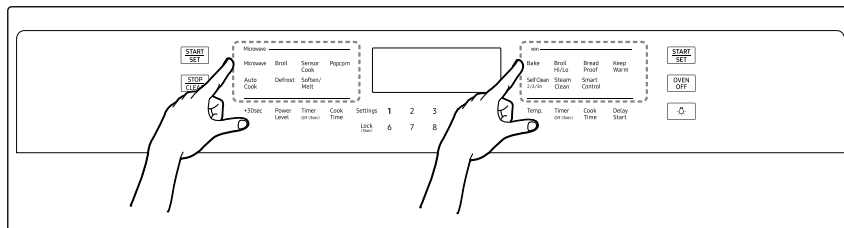

Setting the clock

The clock must be set to the correct time of day for the automatic oven timing functions to work properly.

- The time of day cannot be changed during timed cooking, delay-timed cooking, or a self-cleaning cycle.
- You can choose between a 12-hour or 24-hour display. The default is 12-hour.

How to set the clock

1. Touch **Clock**.
2. Touch **Clock** to select AM or PM. (Skip this step if you are setting the clock to 24 hour display mode.)
3. Touch keys in the number pad to set the current time of day.
4. Touch **Clock** or **START/SET** to save the changes.

Setting the kitchen timer

The kitchen timer serves as an extra timer that will beep when the set time has elapsed. It does not start or stop cooking functions. You can use the kitchen timer with any of the other oven functions.

How to set the timer

1. Touch **Timer Off (3sec)**.
2. Touch number keys in the number pad to set the hours and minutes. The timer can be set for any amount of time from 1 minute to 9 hours and 59 minutes. If you make a mistake, touch **Clear**, and then enter the amount of time again.
3. Touch **START/SET**.
4. When the set time has elapsed, the oven will beep and the display will show End until you touch **Timer Off (3sec)**. You can cancel the timer at any time by touching **Timer Off (3sec)**.

Control Lockout

Control Lockout lets you lock the buttons on the touch pad so they cannot be activated accidentally. Control Lockout also locks the lower oven door only so it cannot be opened. You can only activate Control Lockout when the oven is in standby mode.

How to activate the Control Lockout

1. Cancel or turn off all other functions.
2. Touch **Lock (3sec)** for 3 seconds.
The oven will display “**Loc**” and the lock icon along with the current time.

NOTE

- Control Lockout is available only when the oven temperature is under 400 °F.
- All other functions must be cancelled before you activate Control Lockout.

How to unlock the controls

Touch **Lock (3sec)** for 3 seconds.
“**Loc**” and the lock icon will disappear from the display.

NOTE

It may take up to 10 seconds for the doors to unlock.

Setting the power level

1. Touch **Power Level** to set the power level of the microwave.
2. Enter the power level you want by using the number pad.
You can set the power level from 10 % to 100 % in 10 % increments.

Timed Cooking

In Timed Cooking mode, the oven turns on immediately and cooks for the length of time you select. At the end of the cooking time, the oven turns off automatically.

- You can use Timed Cooking only with another cooking operation (Microwave, Broil, Speed Broil).

How to set the oven for Timed Cooking

1. Touch the pad for the cooking operation you want, eg. **Microwave**.
Enter the power level or temperature you want, for example, 100 %, using the number pad.
2. Touch **Cook Time**. Enter the number of hours/minutes you want the oven to stay on using the number pad. You can set the cooking time for any amount of time from 1 second to the maximum time for each function.
3. Touch **START/SET** to begin cooking.
The oven will continue to cook until the set amount of time has elapsed, then turn off automatically.
4. You can cancel a cook time at any time by touching **STOP/CLEAR**.

-  When Timed Cooking is done, the oven will beep.

Basic operations







Minimum and maximum settings

All the features listed in the table below have minimum and maximum times, temperatures, and power level settings. A beep will sound each time a pad on the control panel is pressed and the entry is accepted. An error tone will sound in the form of a long beep if the entered temperature or time is below the minimum or above the maximum setting for the feature.

Upper Microwave Oven

FEATURE	TEMP./POWER RANGE	MAX. TIME
Microwave Oven	10-100 %	1 Hr. 30 min.
Broil	-	1 Hr. 30 min.

Lower Oven

LOWER OVEN			
	Bake	175 °F (80 °C)	550 °F (285 °C)
	Broil	LO	HI
	Bread Proof	-	12 Hrs.
	Keep Warm	-	3 Hrs.
	Self Clean	2 Hrs.	5 Hrs.
	Steam Clean	20 Min.	20 Min.

Microwave Oven (Upper Oven)

Microwave

Microwaves are high-frequency electromagnetic waves that can be used to cook or reheat food without changing either the form or color of the food.

1. Put food in a microwave-safe container, and then place the container in the center of the turntable. Close the door.
2. Touch **Microwave**.
3. Touch **Power Level**, and then use the number pad to input a desired power level.
4. Touch **Cook Time**, and then use the number pad to input a desired cook time. You can also use the **+30sec** button to add cooking time in 30 second increments. (Maximum cooking time is 1 Hr. 30 min.)
5. Touch **START/SET** to start cooking.
6. If you want to cancel Microwave cooking or if Microwave cooking is finished, touch **STOP/CLEAR**.

Power level

100 %	(High)	50 %	(Medium)
90 %	(Sauté)	40 %	(Medium low)
80 %	(Reheat)	30 %	(Low)
70 %	(Medium high)	20 %	(Defrost)
60 %	(Simmer)	10 %	(Warm)

CAUTION

- Use only microwave-safe cookware.
- Do not use wire racks with Microwave mode.

Broil

The upper oven broil function uses a standard electronic heating element to broil food. It does not use microwave energy. When using the broil mode, do not put food in plastic, microwave-safe cookware. The cookware will melt.

Use glass, ceramic, or metal cookware. To broil food, follow the steps below.

1. Put the rack on the turntable. Put the cookware containing the food on the rack.
2. Touch **Broil**. If preheating is preferred, simply touch **START/SET**.

 **NOTE**

You cannot set the temperature in Broil mode.

3. Touch **Cook Time**, and then use the number pad to specify a cooking time. (Maximum cooking time is 1 Hr. 30 min.)
4. Touch **START/SET** to start cooking.
5. If you want to cancel Broiling or if Broiling is finished, touch **STOP/CLEAR**.

 **CAUTION**

For the Broil function:

- Use glass, ceramic, or metal cookware.
- Do not use plastic cookware.
- Use oven gloves when taking out food.

Popcorn

You do not need to set either the cooking time or the power level. Once you have selected Popcorn and touched **START/SET**, the oven automatically sets the cooking time and starts to cook. The gas sensing animation effect shows the status of the sensing process.

1. Touch **Popcorn**.
2. Touch **START/SET** to start cooking.
3. If you want to cancel the Popcorn function or if the Popcorn function is finished, touch **STOP/CLEAR**.

 **CAUTION**

- Use only microwave-safe cookware.
- Use oven gloves when taking out food.

Code/Food	Amount	Instructions
Popcorn	3.0-3.5 oz. 1 package	Use only one microwave popcorn bag at a time. Be careful when removing the heated bag from the oven and when opening it.

Microwave Oven (Upper Oven)

Defrost

The oven provides 4 different defrosting programs for your convenience. The time and power levels are automatically adjusted according to your selection.

1. Put food in suitable cookware, then put the cookware on the turntable and close the door.
2. Touch **Defrost**, and then use the number pad to select a program.
3. Touch **START/SET** to move to the next step.
4. Use the number pad to select the weight of food.
5. Touch **START/SET** to start cooking.
6. If you want to cancel Defrost or if Defrost is finished, touch **STOP/CLEAR**.

CAUTION

- Use only microwave-safe cookware.
- Use oven gloves when taking out food.

Code/Food	Amount	Instructions
1 Meat	0.1-3.5 lbs.	Shield the edges with aluminium foil. Turn the meat over when the oven beeps. This program is suitable for lamb, pork, steaks, chops, and ground meat. For ground meat, place the meat directly on the turntable tray on wax paper. Do not use an extra tray. Let stand, covered with foil, for 5-10 minutes.
2 Poultry	0.1-3.5 lbs.	Shield the leg and wing tips with aluminium foil. Turn the poultry over when the oven beeps. This program is suitable for whole chicken as well as for chicken portions.

Code/Food	Amount	Instructions
3 Fish	0.1-3.5 lbs.	Shield the tail of a whole fish with aluminium foil. Turn the fish over when the oven beeps. This program is suitable for whole fish as well as for fish fillets.
4 Bread	0.1-2.0 lbs.	Put bread on a piece of paper towel. Turn over as soon as the oven beeps. This program is suitable for all kinds of bread, sliced or whole, as well as for bread rolls and baguettes. Arrange bread rolls in a circle.

Sensor Cook

The 15 Sensor Cook features include/provide pre-programmed cooking times. You do not need to set either the cooking time or the power level. Once you have selected a program and touched **START/SET**, the oven automatically sets the cooking time and starts to cook. The gas sensing animation effect shows the status of the sensing process.

1. Put the food in the center of the turntable and close the door.
2. Touch **Sensor Cook**, and then use the number pad to select a program.
3. Touch **START/SET** to start cooking.
4. If you want to cancel Sensor Cook or if Sensor Cook is finished, touch **STOP/CLEAR**.

CAUTION

- Use only microwave-safe cookware.
- Use oven gloves when taking out food.

Code/Food	Amount	Instructions
1 Potato	1 to 5 ea.	Pierce each potato several times with a fork. Place on the turntable in a spoke-like fashion. After cooking, let the potatoes stand for 3-5 minutes. Let the oven cool for at least 5 minutes before using it again.
2 Pizza	1 to 4 slices	Place 1-4 pizza slices on a microwave safe plate with the wide ends of the slices towards the outside edge of the plate. Do not let the slices overlap. Do not cover. Let the oven cool for at least 5 minutes before using it again.

Code/Food	Amount	Instructions
3 Beverage	6 to 8 oz. (½ cup to 1 cup)	Use a measuring cup or mug and do not cover. Place the beverage in the oven. After heating, stir well. Let the oven cool for at least 5 minutes before using it again.
4 Dinner Plate	1 serving	Use only precooked, refrigerated foods. Cover the plate with vented (1 inch vent) plastic wrap or waxed paper tucked under the plate. If the food is not as hot as you would like after using the “Sensor” function, continue heating using additional time and power. Contents: <ul style="list-style-type: none"> • 3-4 oz. meat, poultry, or fish (up to 6 oz. with bone) • ½ cup starch (potatoes, pasta, rice, etc.) • ½ cup vegetables (about 3-4 oz.)
5 Casserole	1 to 4 servings	Cover the plate with vented (1 inch vent) plastic wrap. If the food is not as hot as you would like after using the “Sensor” function, continue heating using additional time and power. Stir the food once before serving. Contents: Casseroles: refrigerated

Microwave Oven (Upper Oven)

Code/Food	Amount	Instructions
6 Pasta	1 to 4 servings	Cover the plate with vented (1 inch vent) plastic wrap. If the food is not as hot as you would like after using the "Sensor" function, continue heating using additional time and power. Stir the food once before serving. Contents: Pasta: canned spaghetti
7 Soup	1 to 4 servings	Cover the plate with vented (1 inch vent) plastic wrap. If the food is not as hot as you would like after using the "Sensor" function, continue heating using additional time and power. Stir the food once before serving. Contents: Soup: refrigerated
8 Frozen Breakfast	4 to 8 oz.	Use this button for frozen sandwiches, breakfast entrees, pancakes, waffles, etc. Follow the package instructions for covering and standing. Let the oven cool for at least 5 minutes before using it again.
9 Frozen Dinner	13 to 18 oz.	Remove the food from its wrapping and follow the instructions on the box for covering and letting stand. Let the oven cool for at least 5 minutes before using it again.

Code/Food	Amount	Instructions
10 Rice	1 to 2 cups	Add 1 cup of cold water for 1 cup of rice. Use a large glass pyrex bowl. Cover with vented (1 inch vent) plastic wrap. Rice doubles in volume during cooking. After the cooking time is over, stir before standing time, and then salt or add herbs and butter.
11 Mini Ravioli	8 to 14 oz.	Put mini ravioli evenly into a microwave safe glass bowl. Cover with vented (1 inch vent) plastic wrap. Let stand for 2-3 minutes. Stir the food once before serving.
12 Fresh Vegetables	1 to 4 servings	Place the fresh vegetables (broccoli florets, cauliflower florets, zucchini, egg plants etc.) in a microwave safe ceramic, glass, or plastic dish and add 2-4 tbsp. water. Cover with vented (1 inch vent) plastic wrap while cooking and stir before letting stand. Let the oven cool for at least 5 minutes before using it again.
13 Fresh Root Vegetables	1 to 4 servings	Place the fresh vegetables (carrots, leeks, potatoes, beet etc.) in a microwave safe ceramic, glass, or plastic dish and add 2-4 tbsp. water. Cover with vented (1 inch vent) plastic wrap while cooking and stir before letting stand. Let the oven cool for at least 5 minutes before using it again.

Code/Food	Amount	Instructions
14 Frozen Vegetables	1 to 4 servings	Place the frozen vegetables in a microwave safe ceramic, glass, or plastic dish and add 2-4 tbsp. water. Cover with vented (1 inch vent) plastic wrap to cook. Stir before letting stand for 3-5 minutes. Let the oven cool for at least 5 minutes before using it again.
15 Canned Vegetables	1 to 4 servings	Place the canned vegetables in a microwave safe ceramic, glass, or plastic dish. Cover with vented (1 inch vent) plastic wrap while cooking and stir before letting stand. Let the oven cool for at least 5 minutes before using it again.

Notes on Sensor Cooking

The Auto Sensor cooks your food automatically by detecting the amount of gases generated from the food while it is cooking.

- When food is cooked, many kinds of gases are generated. The Auto Sensor determines the proper time and power level by detecting these gases, eliminating the need to set the cooking time and power level.
- When a container is covered with its lid or plastic wrap during Sensor Cooking, the Auto Sensor will detect the gases generated after the container has been saturated with steam.

NOTE

If using cling film or plastic wrap, leave a small opening (vent) near the edge of the dish for ventilation or pierce the plastic with a knife or fork in several places.

- Shortly before cooking ends, the microwave will begin to count down the remaining cooking time. This will be a good time for you to rotate or stir the food for even cooking if it is necessary.
- Before you begin Auto Sensor cooking, you can season food with herbs, spices, or browning sauces. A word of caution though: Salt or sugar may cause burn spots on food so these ingredients should be added after cooking.

Utensils & covers

- To obtain good cooking results with the Auto Sensor function, follow the directions in the tables in this manual for selecting appropriate containers and covers.
- Always use microwave-safe containers and cover them with their lids or with plastic wrap. When using plastic wrap, turn back one corner to allow steam to escape at the proper rate.
- Always cover your microwave safe dish or container with its matching lid. If the dish or container does not have its own lid, use plastic wrap.
- Fill containers at least half full.
- Foods that require stirring or rotating should be stirred or turned toward the end of the Sensor Cook cycle, after the time has started to count down on the display.

Microwave Oven (Upper Oven)

CAUTION

- After installing the oven and plugging it into an electrical outlet, do not unplug the power cord for 24 hours. The gas sensor needs time to stabilize in order to cook satisfactorily.
- It is not advisable to use the Auto Sensor cooking feature continuously. i.e. one cooking operation immediately after another.
- Install the oven in a well ventilated location for proper cooling and airflow and to ensure the sensor will operate accurately.
- To avoid poor results, do not use the Auto Sensor cooking function when the room ambient temperature is above 90 °F or below 45 °F.
- Do not use a volatile detergent to clean your oven. Gas resulting from this detergent may affect the sensor.
- Avoid placing the oven near high moisture or gas emitting appliances, since this will interfere with the proper performance of the Auto Sensor.
- Always keep the inside of the oven clean. Wipe all spills with a damp cloth. This oven is designed for household use only.

Auto Cook

You do not need to set either the cooking time or the power level. You can adjust the size of the serving.

1. Put the food in the center of the turntable and close the door.
2. Touch **Auto Cook**, and then use the number pad to select the appropriate food code.
3. Touch **START/SET** to go to the next step.
4. Use the number pad to specify amount of servings.
5. Touch **START/SET** to start cooking.
6. If you want to cancel Auto Cook or if Auto Cook is finished, touch **STOP/CLEAR**.

CAUTION

- Use only microwave-safe cookware.
- Use oven gloves when taking out food.

Code/Food	Amount	Instructions
1 Bacon	1 serving: 2 slices 2 servings: 4 slices 3 servings: 6 slices	Layer 2 paper towels on a microwave safe plate and arrange the bacon on the towels. Do not overlap bacon. Cover with an additional paper towel. Remove the paper towel immediately after cooking.
2 Hot dog	1 serving: 2 each 2 servings: 4 each	Pierce the hot dogs 3 times with a fork. Place the hot dogs on a glass or ceramic plate, then place the plate on the rack. When the microwave beeps, add the buns and press start to continue.

Code/Food	Amount	Instructions
3 Oatmeal	1 serving: 1 pack 2 servings: 2 packs	Follow the package directions for the recommended amount of water needed. Stir well before and afterwards.
4 Nachos	1 serving	Arrange the tortilla chips uniformly on a glass or ceramic plate, then place the plate on the rack. Sprinkle evenly with cheese. Contents: <ul style="list-style-type: none"> • 4 to 5 oz. tortilla chips • ½ cup grated cheese
5 Baked Potato	1 serving: 2 each 2 servings: 4 each	Pierce the potatoes 3 times with a fork. Place the potatoes on a glass or ceramic plate, then place the plate on the rack. After cooking, let the potatoes stand for 3-5 minutes.
6 Quinoa	1 serving: 1 cup 2 servings: 2 cups	Follow the package directions for the recommended amount of water needed. If there are no directions, add an amount of water equal to the amount of Quinoa. Stir well before and after cooking.
7 Frozen Buffalo wings	1 serving: 12 oz. 2 servings: 16 oz.	Place the frozen chicken wings on a glass or ceramic plate, then place the plate on the rack.

Code/Food	Amount	Instructions
8 Frozen French Fries	12 oz. 16 oz.	Place the frozen french fries on a glass or ceramic plate, then place the plate on the rack.
9 Frozen Chicken Nuggets	8 oz. 16 oz.	Place the frozen chicken nuggets on a glass or ceramic plate, then place the plate on the rack.
10 Frozen Pizza, 6 inch	6 inch	Place the pizza on the rack.
11 Frozen Pizza, 12 inch	12 inch	Place the pizza on the rack.
12 Bone-in Chicken Pieces	1.0 lb. 2.0 lbs.	Brush the chicken pieces with oil and seasonings. Place the pieces skin side down on the rack. When the microwave beeps, turn over bone-in chicken pieces, and then press Start to continue.
13 Hamburger	1 serving: 2 ea. 2 servings: 4 ea. (1 ea. = 4 oz.)	Place the hamburgers on a glass or ceramic plate. Place the plate on the rack. When the microwave beeps, turn the hamburgers over, and then press Start to continue.
14 Salmon Steak	2 servings: 2 ea. 4 servings: 4 ea. (1 ea. = 5 to 6 oz.)	Brush the salmon fillets with oil and seasonings. Place the salmon fillets on a glass or ceramic plate, then place the plate on the rack.

Microwave Oven (Upper Oven)

Code/Food	Amount	Instructions
15 Sirloin Steak, Medium	1 inch, 1.0 lb.	Place the steak on the rack. When the microwave beeps, turn over the steak, and then press Start to continue. Let the steak rest for 5 minutes before slicing. Brush the steaks with oil and seasonings.
16 Sirloin Steak, Well done	1 inch, 1.0 lb.	Place the steak on the rack. When the microwave beeps, turn over the steak, and then press Start to continue. Let the steak rest for 5 minutes before slicing. Brush the steaks with oil and seasonings.
17 Boneless Pork Chops	2 servings: 2 ea. 4 servings: 4 ea. (1 ea. = 5 to 6 oz.)	Place the pork chops on the rack. When the microwave beeps, turn over the pork chops, and then press Start to continue. Brush the pork chops with oil and seasonings.

Soften/Melt

You do not need to set either the cooking time or the power level.

1. Put the food in the center of the turntable and close the door.
2. Touch **Soften/Melt** to select a program.
3. Touch **START/SET** to go to the next step.
4. Use the number pad to specify the weight of food.
5. Touch **START/SET** to start cooking.
6. If you want to cancel Soften/Melt or if Soften/Melt is finished, touch **STOP/CLEAR**.

CAUTION

- Use only microwave-safe cookware.
- Use oven gloves when taking out food.

Code/Food	Amount	Instructions
1 Melt Butter	0.25 lb. (1 stick) 0.5 lb. (2 sticks)	Unwrap the butter and cut the butter into several pieces. Place the butter on a microwave safe dish and cover with wax paper. Stir well afterwards.
2 Soften Butter	0.25 lb. (1 stick) 0.5 lb. (2 sticks)	Remove the butter from the packaging and place on a microwave safe dish.
3 Melt Chocolate	1 cup chips	Place the chocolate chips in a microwave safe dish. When the microwave beeps, stir well, and then press Start to continue. Unless stirred, the chocolate chips will keep their shape even when the heating time is over.

Code/Food	Amount	Instructions
4 Soften Ice Cream	1 serving: 1 pint 2 servings: 1.5 quarts	Remove the lid of the carton. Place the carton in the center of the microwave.
5 Soften Cream Cheese	4 oz. 8 oz.	Unwrap the cream cheese and place on a microwave safe dish.
6 Melt Cheese	4 oz. 8 oz.	Place the cheese in a microwave safe bowl and cover with wax paper. Stir well afterwards.
7 Melt Marshmallows	5 oz. 10 oz.	Place the marshmallows in a large microwave safe dish. Stir well afterwards.
8 Melt Caramel	4 oz. 8 oz.	Place the caramel in a large microwave safe dish. Stir well afterwards.

Oven (Lower Oven)

Timed Cooking

In Timed Cooking mode, the oven turns on immediately and cooks for the length of time you select. At the end of the cooking time, the oven turns off automatically.

- You can use Timed Cooking only with the Bake cooking operation.

How to set the oven for Timed Cooking

- Touch the pad for the cooking operation you want, eg. **Bake**. Enter the temperature you want, for example, 400 °F, using the number pad. (The default temperature is 350 °F).
- Touch **Cook Time**. Enter the number of hours/minutes you want the oven to stay on using the number pad. You can set the cooking time for any amount of time from 1 minute to 9 hours and 59 minutes.
- Touch **START/SET** to begin cooking. The temperature display will start to change once the oven temperature reaches 175 °F. The oven will continue to cook until the set amount of time has elapsed, then turn off automatically.
- You can cancel a cook time at any time by setting the cook time to 0 minutes. (Touch **Cook Time** -> set cook time to 0 min -> touch **START/SET**)

 When Timed Cooking is done, the oven will beep.

CAUTION

Use caution with the **Timed Cooking** or **Delay Start** features. You can use these features to cook cured or frozen meats and most fruits and vegetables. For food that can easily spoil, such as milk, eggs, and unfrozen or fresh fish, meat, or poultry, chill them in the refrigerator first. Even when chilled, they should not stand in the oven for more than 1 hour before cooking begins, and should be removed promptly when cooking is completed. Eating spoiled food can result in sickness from food poisoning.

Oven (Lower Oven)

Delay Start

With Delay Start, the oven's timer turns the oven on and off at times you select in advance.

- You can use Timed Cooking only with the Bake cooking operation.
- You can set the oven for a delay start before setting other cooking operations.
- The clock must be set to the current time.

How to set the oven for delay start

1. Position the oven rack(s) and place the food in the oven.
2. Touch the pad for the cooking operation you want, eg. **Bake**.
The default temperature is 350 °F.
3. Enter the temperature you want, eg. 375 °F, using the number pad.
4. Set the cooking time if you want. (Refer to the section on the Timed Cooking feature on page 33).
5. Touch **Delay Start**. Use the number pad to set the time.
6. Touch **START/SET**. At the set time, a short beep will sound. The oven will begin to cook.

Turning the light on and off

- The oven light turns on automatically when the door is opened.
- The oven light turns off automatically when the door is closed.
- You can turn the oven and door light on and off manually by touching the



Using the oven racks

Oven rack positions

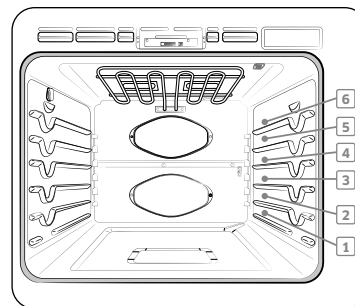

Recommended rack position for cooking

TYPE OF FOOD	RACK POSITION
Broiling hamburgers	6
Broiling meat or small cuts of poultry, fish	3-5
Bundt cakes, pound cakes, frozen pies, casseroles	4 or 3
Angel food cakes, small roasts	2
Turkey, large roasts, hams, fresh pizza	1

- This table is for reference only.

Rack and Pan placement

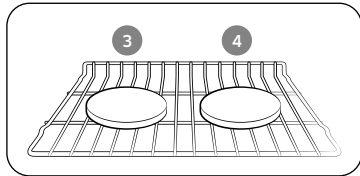

Single Oven Rack

Centering baking pans in the oven as much as possible will produce better results. If baking with more than one pan, place the pans so each has at least 1" to 1½" of air space around it.

When baking on a single oven rack, place the oven rack in **position 3** or **4**. See the figure on the left.

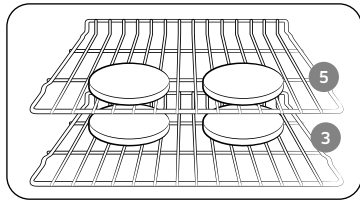

Multiple Oven Rack

When baking cakes and cookies on multiple racks, place the oven racks in **positions 3** and **5**.

Using multiple oven racks

Type of baking	Rack positions
Cakes and cookies	3 and 5

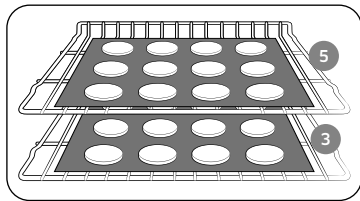

Multiple Oven Rack

Before using the racks

Each rack has stops that need to be placed correctly on the supports. These stops will keep the rack from coming completely out.

Removing the racks

1. Pull the rack straight out until it stops.
2. Lift up the front of the rack, and then pull it out.

Replacing the racks

1. Place the end of the rack on the support.
2. Tilt the front end up and push the rack in.

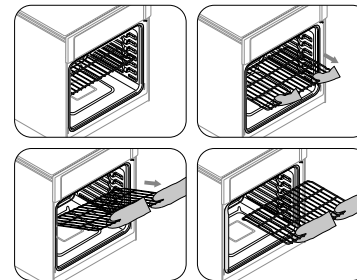

CAUTION

- Do not cover a rack with aluminum foil or place aluminum foil on the oven bottom. This will hamper heat circulation, resulting in poor baking, and may damage the oven bottom.
- Arrange the oven racks only when the oven is cool.

Oven (Lower Oven)

Baking

The oven can be programmed to bake at any temperature from 175 °F to 550 °F. Baking temperature and time will vary depending on the ingredients and the size and shape of the baking pan used. Dark or nonstick coatings may cook faster with more browning.

How to set the oven for baking

1. Touch **Bake**.
2. Enter the temperature you want using the number pad, eg. 3, 7, 5.
3. Touch **Cook Time**, and then use the number pad to set the cooking time.
4. Touch **START/SET**. The temperature display will start to change once the oven temperature reaches 175 °F.
5. If you want to cancel baking or if you have finished, touch **OVEN OFF**.

 Place food in the oven after preheating if the recipe calls for it. Preheating is very important for good results when baking cakes, cookies, pastry, and breads. After the oven has reached the desired temperature, the oven will beep 6 times.

NOTE

If you are using an oven thermometer in the oven cavity, the temperature registered by the thermometer may differ from the actual set oven temperature.

How to adjust the temperature while cooking

1. Touch **Temp.**. The display will show the present temperature, eg. 375 °F.
2. Enter the temperature you want, eg. 425 °F, using the number pad.
3. Complete the entry by touching **START/SET**.

Broiling

Broiling is a method of cooking tender cuts of meat by direct heat under the broil element of the oven.

The high heat cooks quickly and gives a rich, brown outer appearance. Broil mode is best for meat, fish, and poultry up to 1" thick.

How to set the oven for broiling

1. Touch **Broil** once for Hi or twice for Lo.
Use Lo to cook foods such as poultry or thick cuts of meat thoroughly without over-browning them.
2. To start broiling, touch **START/SET**.
Broil one side until the food is browned. Turn over and broil the other side.
3. Touch **OVEN OFF** once you have finished cooking or if you want to cancel broiling.

NOTE

- This oven is designed for CLOSED DOOR broiling. The oven door must be closed during broiling.
- If you leave the oven door open for more than 2 minutes when the oven is on, all heating elements will shut off automatically.
- When you have finished cooking, the cooling fan will continue to run until the oven has cooled down.
- If you are using an oven thermometer in the oven cavity, the temperature registered by the thermometer may differ from the actual set oven temperature.

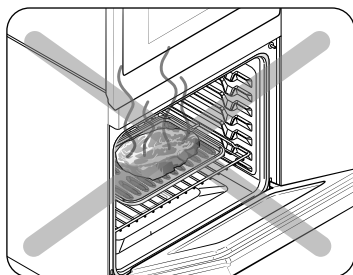

⚠ CAUTION

Always broil with the oven door closed. Use care when opening the door. Let hot air or steam escape before you remove food from or put food into the oven.

Broiling recommendation guide

The size, weight, thickness, starting temperature, and your doneness preference will affect broiling times. This guide is based on meats at refrigerator temperature. Always use a broiler pan and its grid when broiling. Always preheat the oven for 5 minutes before broiling.

Food	Doneness	Size	Thickness	Level	Rack position	Cooking time (min.)	
						1st side	2nd side
Hamburgers	Medium	9 patties	3/4"	Hi	6	3:00	2:00
	Medium	9 patties	1"	Hi	6	3:20	2:20
Beef steaks	Rare	-	1"	Hi	5	5:00	4:00
	Medium	-	1- 1 1/2"	Hi	5	6:00-6:30	4:30-4:00
	Well done	-	1- 1 1/2"	Lo	4	7:00-8:00	4:00-5:00
Chicken pieces	Well done	4.5 lbs.	1/2-3/4"	Lo	3	16:00-18:00	13:00-15:00
	Well done	2 lbs.	1/2-3/4"	Lo	3 or 4	15:00-16:00	10:00-12:00
Pork chops	Well done	1 lbs.	1"	Lo	3	8:00-10:00	6:00-8:00
Fish fillets	Well done	-	1/4-1/2"	Lo	3 or 4	7:00-8:00	4:00-5:00

Using Bread Proof

Bread Proof provides an optimal temperature for the bread proofing process and therefore does not require a temperature adjustment.

For the best results, always start the Bread Proof option with a cool oven.

1. Touch **Bread Proof**.
2. Touch **START/SET**.
3. Touch **OVEN OFF** at any time to turn off Bread Proof.

📄 NOTE

Use rack position 3 for Bread Proof.

Using Keep Warm

Keep Warm will keep cooked food warm for serving up to 3 hours after cooking has finished.

After 3 hours, the feature will shut off automatically. You can use the Keep Warm feature without any other cooking operations or you can set it to activate after a timed or delay timed cooking operation.

You should not use this feature to reheat cold food.

How to use Keep Warm

1. Touch **Keep Warm**.
2. Touch **START/SET**.
3. Touch **OVEN OFF** at any time to turn the feature off.

How to set the oven to activate Keep Warm after a timed cooking

1. Set up the oven for **Timed cooking**.
(Refer to the **Timed Cooking** section on page 33.)
2. Touch **Keep Warm** before touching **START/SET** to begin cooking.
3. Touch **OVEN OFF** at any time to turn the feature off.

Oven (Lower Oven)

Using Settings

This function lets you control various electronic control settings. These settings include Temp Adjust, Temp Unit, Time of Day, 12 hour energy saving, Sound On/Off, and Demo mode.

The setting menu is only available when the oven is not being used (not cooking).

Options	Feature
1. Temp Adjust	Lets you correct the temperature in the oven.
2. Temp Unit	Lets you program the oven control to display temperatures in Fahrenheit or Centigrade.
3. Time of Day	Lets you set the clock to display the time of day in the 12 hour or 24 hour mode.
4. 12 hour energy saving	This feature automatically turns off the oven after 12 hours during baking functions or after 3 hours during a broil function.
5. Sound On/Off	Lets you set the oven controls to operate silently.
0. Demo mode	This option is for use by retail establishments for display purposes only.

Temp Adjust

The temperature in the oven has been calibrated at the factory. When first using the oven, be sure to follow recipe times and temperatures. If you think the oven is too hot or too cool, you can correct the temperature in the oven. Before correcting, test a recipe by using a temperature setting that is higher or lower than the recommended temperature. The baking results should help you to decide how much of an adjustment is needed.

The oven temperature can be adjusted ± 35 °F (± 19 °C).

How to correct the oven temperature

1. Touch **Settings**, and then **1** on the number pad.
2. Touch **Settings** to set the temperature higher or lower than the current temperature.
3. Enter the adjustment you want to make using the number pad. (± 35)
4. Touch **START/SET** to save the changes.

NOTE

This adjustment will not affect the broiling or the self-cleaning temperatures. The adjustment will be retained in memory after a power failure.

Temp Unit (Fahrenheit or Celsius temperature selection)

You can program the oven control to display the temperature in Fahrenheit or Celsius. The oven has been preset at the factory to display in Fahrenheit.

How to change the display from Fahrenheit to Celsius or Celsius to Fahrenheit

1. Touch **Settings**, and then **2** on the number pad.
2. Touch **1** (Fahrenheit) or **2** (Celsius) on the number pad.
3. Touch **START/SET** to save the changes.

Time of Day (12hr/24hr)

The oven control can be programmed to display the time of day in the 12 hour or 24 hour mode.

The oven has been preset at the factory to display in the 12 hour mode.

How to change between the 12 and 24 hour time of day display

1. Touch **Settings**, and then **3** on the number pad.
2. Touch **1** (12hr) or **2** (24hr) on the number pad.
3. Touch **START/SET** to save the changes.

12 hour energy saving

If you accidentally leave the oven on, this feature will automatically turn off the oven after 12 hours during baking functions or after 3 hours during a broil function.

How to turn the 12 hour energy saving feature on or off

1. Touch **Settings**, and then **4** on the number pad.
2. Touch **1** (On) or **2** (Off) on the number pad.
3. Touch **START/SET** to save the changes.

Sound On/Off

Using Sound On/Off, you can set the oven controls to operate silently.

How to turn the sound on or off

1. Touch **Settings**, and then **5** on the number pad.
2. Touch **1** (On) or **2** (Off) on the number pad.
3. Touch **START/SET** to save the changes.

Demo mode

This option is for use by retail establishments for display purposes only.

(When Demo mode is on, the heating element is disabled and does not operate.)

How to enable or disable the demo mode

1. Touch **Settings**, and then **0** on the number pad.
2. Touch **1** (On) or **2** (Off) on the number pad.
3. Touch **START/SET** to save the changes.

Oven (Lower Oven)

Using the Sabbath feature

(For use on the Jewish Sabbath & Holidays)



For further assistance, guidelines for proper usage, and a complete list of models with the Sabbath feature, please visit <http://www.star-k.org>.

You can use the Sabbath feature with baking only. The oven temperature may be set higher or lower after you set the Sabbath feature. (The oven temperature adjustment feature should be used only during Jewish holidays.) The display, however, will not change and tones will not sound when a change occurs. Once the oven is properly set for baking with the Sabbath feature active, the oven will remain on continuously until the Sabbath feature is cancelled. This will override the factory preset 12 hour energy saving feature. If the oven light is needed during the Sabbath, touch  before activating the Sabbath feature. Once the oven light is turned on and the Sabbath feature is active, the oven light will remain on until the Sabbath feature is turned off. If the oven light needs to be off, be sure to turn the oven light off before activating the Sabbath feature.

How to use the Sabbath feature

1. Touch **Bake**. The default temperature is 350 °F.
2. Enter the temperature you want, eg. 375 °F, by using the number pad.
3. Touch **START/SET**.
The temperature display will start to change once the oven temperature reaches 175 °F.
4. Touch **Bake** and the **Number 1** at the same time for 3 seconds.
The display will show **SAb**.
Once SAb appears in the display, the oven will not beep or display any further changes.
You may change the oven temperature once baking has started. Remember that the oven will not beep or display any further changes once the Sabbath feature is engaged.
5. You can turn the oven off at any time by touching **OVEN OFF**. This will turn only the oven off. If you want to deactivate the Sabbath feature, touch **Bake** and the **Number 1** at the same time for 3 seconds. SAb will disappear from the display.

CAUTION

- Do not attempt to activate any other program feature except Bake while the Sabbath feature is active. ONLY the following key pads will function correctly with the Sabbath feature on: **Number**, **Temp.**, **START/SET** and **OVEN OFF**. All other keys should not be used once the Sabbath feature is activated.
- Do not open the oven door or change the oven temperature for about 30 minutes after you have started Sabbath mode to allow the oven to reach the set temperature. Note that, for best performance, the oven fan operates only when the oven temperature is rising.

NOTE

- You can change the oven temperature, but the display will not change and tones will not sound when a change occurs. (The oven temperature adjustment feature should be used only on Jewish holidays.) After changing the temperature while the unit is in Sabbath mode, there is a 15 second delay before the unit recognizes the change.
- You can set the Cook time function before activating the Sabbath feature.
- Should there be a power failure or interruption, the oven will shut off. When power is returned, the oven will not turn back on automatically. SAb will be displayed in the oven control display, but the oven will not operate. Food may be safely removed from the oven while it is still in the Sabbath mode, however the oven cannot be turned back on until after the Sabbath/Holidays. After the Sabbath observance, turn OFF the Sabbath mode. Touch and hold both **Bake** and the **Number 1** for at least 3 seconds simultaneously to turn the Sabbath mode off. The oven can then be used with all normal functions.

Using Smart Control (Lower oven only)

To use the oven's Smart Control, you must download the SmartThings app to a mobile device. Functions that can be operated using the SmartThings app may not work smoothly if communication conditions are poor or the oven is installed in a place with a weak Wi-Fi signal.

Please refer to the following table for the main functions that can be operated from the app.

When Smart Control on the oven is off	Monitoring (Oven), Oven off
When Smart Control on the oven is on.	Monitoring (Oven), Oven start, Oven off, Error check

How to connect the oven

1. Download and open the SmartThings app on your smart device.
2. Follow the app's on-screen instructions to connect your oven.
3. Once the process is complete, the connected  icon located on your oven displays and the app will confirm you are connected.
4. If the connection icon does not turn on, follow the instruction in the app to reconnect.



To start the oven remotely

Touch **Smart Control**.  appears in the display. The oven can now be started and controlled remotely by a connected mobile device.

When Smart Control is on you can:

- Remotely change oven settings (mode, time, temperature) using your mobile device.
- Remotely start the oven.
- Remotely turn off the oven.
- Once cooking starts, you can change the cooking time and temperature remotely.

NOTE

- **Important:** Self clean mode cannot be started remotely.
- Opening the oven door or touching **Smart Control** will delete  from the display and prevent you from turning the oven on or controlling the oven remotely.
- If  is not shown in the display, you can still monitor the oven's status and turn the oven off.
- When oven cooking is finished or cancelled,  will turn off.
- If you use a microwave oven, you may not be able to use the **Smart Control** app due to Wi-Fi signal interference.

Maintaining your appliance

Self-cleaning (Lower oven only)

This self-cleaning oven uses high temperatures (well above cooking temperatures) to burn off leftover grease and residue completely or reduce them to a finely powdered ash that you can wipe away with a damp cloth.

⚠ CAUTION

- During the self-cleaning cycle, the outside of the oven will become very hot to the touch. **Do not** leave small children unattended near the appliance.
- Some birds are extremely sensitive to the fumes given off during the self-cleaning cycle of any oven. Move birds to another well-ventilated room.
- **Do not** line the oven walls, racks, bottom, or any other part of the oven with aluminum foil. Doing so will result in poor heat distribution, poor baking results, and cause permanent damage to the oven interior. Aluminum foil will melt and adhere to the interior surface of the oven.
- The oven door locks during self-cleaning. **Do not** force the oven door open. This can damage the automatic door locking system. Use care when opening the oven door after the self-cleaning cycle is complete. Stand to the side of the oven when opening the door to allow hot air or steam to escape. The oven may still be **VERY HOT**.

Before a self-cleaning cycle

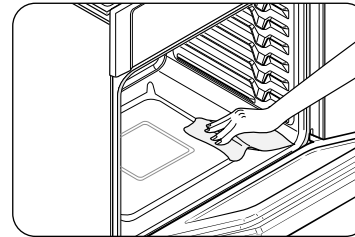

Fig. 1

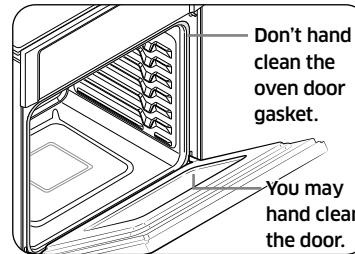

Fig. 2

- We recommend venting your kitchen with an open window or using a ventilation fan or hood during the self-cleaning cycle.
- Remove the wire rack, broil pan, broil pan insert, all cookware, and any aluminum foil from the oven.
- Wipe up debris from the oven bottom. (Fig. 1)
- The silver-colored oven racks can be self-cleaned, but they will darken, lose their luster, and become hard to slide.
- Residue on the front frame of the oven and outside the gasket on the door will need to be cleaned by hand. Clean these areas with hot water, soap-filled steel-wool pads, or cleansers such as Soft Scrub. Rinse well with clean water and dry.
- Do not clean the gasket. The fiberglass material of the oven door gasket cannot withstand abrasion. It is essential for the gasket to remain intact. If you notice it becoming worn or frayed, have it replaced. (Fig. 2)
- Make sure the oven light cover is in place and the oven light is off.

NOTE

Remove oven racks and accessories before starting the self-clean mode.

How to run a self-cleaning cycle

1. Select the length of time for the self-cleaning operation, eg. 3 hours.
Touch **Self Clean 2/3/5h** once for a 3 hour clean time, twice for a 5 hour clean time, or 3 times for a 2 hour clean time. (The default setting is 3 hours.)
2. Touch **START/SET** to start the self-cleaning cycle.
The motor-driven door lock will engage automatically.
IMPORTANT: Both doors lock when you run a self cleaning cycle on either oven.

NOTE

- You will not be able to start a self-cleaning cycle if the Control Lockout feature is activated or if the oven's temperature is too hot.
 - The oven doors lock automatically. The display will show the cleaning time remaining. You cannot to open the oven doors until the temperature drops to a safe/cool temperature.
 - The self-clean feature can be used in only one oven at a time. While one oven is in self-cleaning mode, you cannot use the other oven for cooking.
3. When the self-cleaning cycle is done, End will appear in the display and the oven will beep 6 times.

How to delay the start of self-cleaning

1. Touch **Self Clean 2/3/5h**.
Select the desired self-clean time by touching **Self Clean 2/3/5h**.
2. Touch **Delay Start**.
3. Enter the time you want the self-clean cycle to start.
4. Touch **START/SET**.
The display will show Delay, Self clean, and the Lock icon. The motor-driven door lock will engage automatically.
5. The Self-Cleaning cycle will turn on automatically at the set time.

How to turn off the self-cleaning feature

If you need to stop or interrupt a self-cleaning cycle:

1. Touch **OVEN OFF**.
2. You will be able to open the oven door once the oven has cooled down for approximately 1 hour.

After a self-cleaning cycle

- You may notice some white ash in the oven. Wipe it up with a damp cloth after the oven cools. (If white spots remain, remove them with a soap-filled steel wool pad and rinse thoroughly with a vinegar and water mixture.)
- If the oven is not clean after one cycle, repeat the cycle.
- You cannot set the oven for cooking until the oven is cool enough for the door to unlock.

Maintaining your appliance

Wall Oven Steam Clean

How to set the oven for steam-cleaning

For light cleaning, the Steam-cleaning function saves time and energy.
For heavier duty cleaning, use the self-cleaning function.

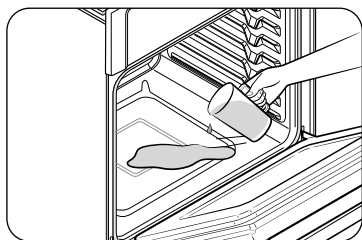

1. Remove all accessories from the oven.
 2. Pour approximately 10 oz. (300 ml) of water onto the bottom of the empty oven and close the oven door. Use tap water only, not distilled water.
 3. Press **Steam Clean**.
 4. Press **START/SET**.
When the operation is complete, the display will blink and a beep will sound.
 5. Press **OVEN OFF**.
 6. Clean the oven's interior.
There will be a significant amount of water remaining on the bottom of the oven after a steam-cleaning cycle. Remove the residual water with a sponge or soft dry cloth.
- ★ When steam-cleaning, use exactly 10 oz. of water since this produces the best results.

NOTE

If you press **Steam Clean** when the oven temperature is above 100 °F, **Hot** will appear in the display. Because these functions produce the best results when started while the oven is cool, we recommend that you wait until the oven has cooled down and **Hot** disappears from the display.

After a steam-cleaning cycle

- Take care when opening the door after a steam-cleaning procedure has ended. The water on the bottom is hot.
- Open the oven door and remove the remaining water with a sponge. Do not leave the residual water in the oven for any length of time. Wipe the oven clean and dry with a soft cloth. Do not forget to wipe under the oven door seal.
- Use a detergent-soaked sponge, a soft brush, or a nylon scrubber to wipe the oven interior. Remove stubborn residue with a nylon scourer. You can remove lime deposits with a cloth soaked in vinegar.
- If the oven remains dirty, you can repeat the procedure once the oven has cooled.
- For heavy residue, such as grease left over from roasting, we recommend that you rub detergent into the residue before activating the steam-cleaning function.
- After cleaning, leave the oven door ajar at a 15° angle to allow the interior enamel surface to dry thoroughly.

Care and cleaning of the oven

Cleaning painted parts and decorative trim

- For general cleaning, use a cloth with hot, soapy water.
- For more difficult residue and built-up grease, apply a liquid detergent directly onto the area and leave for 30 to 60 minutes. Wipe with a damp cloth and dry. Do not use abrasive cleaners on any oven surface. They can be scratched.

Cleaning stainless steel surfaces

1. Shake a bottle of stainless steel appliance cleaner or polish well.
2. Place a small amount of stainless steel appliance cleaner or polish on a damp cloth or damp paper towel.
3. Clean a small area, rubbing with the grain of the stainless steel if applicable.
4. Dry and buff with a clean, dry paper towel or soft cloth.
5. Repeat as necessary.

NOTE

- **Do not use a steel-wool pad. It will scratch the surface.**
- If a mineral oil-based stainless steel appliance cleaner has been used before to clean the appliance, wash the surface with dishwashing liquid and water prior to using the stainless steel appliance cleaner or polish.

Oven racks

If the racks are left in the oven during a self-cleaning cycle, their color will turn slightly blue and the finish will be dull. After the self-cleaning cycle is complete and the oven has cooled, rub the sides of the racks with wax paper or a cloth containing a small amount of oil. This will help the racks glide more easily on their tracks.

NOTE

- Do not clean in a dishwasher.
- If the rack becomes hard to remove or replace, lightly wipe the oven rack guides with cooking oil. Do not wipe cooking oil on the slides.
- If the rack becomes difficult to slide, the rack may need to be lubricated using a graphite lubricant.
- To order graphite lubricant, call Samsung Customer Care at 1-800-SAMSUNG (726-7864) or visit our homepage (www.samsung.com/us/support, www.samsung.com/ca/support, or www.samsung.com/ca_fr/support) and search for part number DG81-01629A.
- If you want to buy it directly, go to <http://www.samsungparts.com>.

Oven door

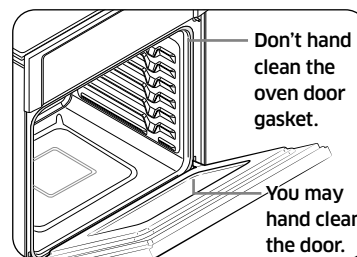

- Use soap and water to thoroughly clean the top, sides, and front of the oven door. Rinse well. You may use a glass cleaner on the outside glass of the oven door. **DO NOT immerse the door in water. DO NOT spray or allow water or the glass cleaner to enter the door vents.** DO NOT use oven cleaners, cleaning powders, or any harsh abrasive cleaning materials on the outside of the oven door.
- **DO NOT clean the oven door gasket.** The oven door gasket is made of a woven material which is essential for a good seal. Care should be taken not to rub, damage, or remove this gasket.

Maintaining your appliance

Removing the oven door (Lower oven only)

⚠ CAUTION

- The door is very heavy. Be careful when removing and lifting the door.
- Do not lift the door by the handle.
Use two hands to remove an oven door.

⚠ WARNING

You can't remove the upper oven door for safety reasons.

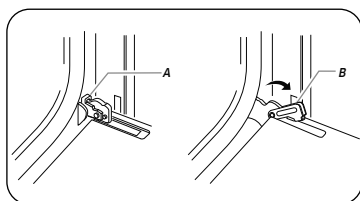

- A. Oven door hinge lock in locked position
- B. Oven door hinge lock in unlocked position

1. Prior to removing the oven door, prepare a surface where you will place it. This surface should be flat and covered with a soft blanket. You can also use the corner posts from your packaging material.
2. Open the oven door.
3. Locate the oven door hinge locks in both corners of the oven door, and then rotate the hinge locks toward the oven door to the unlocked position. If the door hinge lock is not rotated fully (see illustration B on the left for an example of full rotation), you will not be able to remove the door properly.

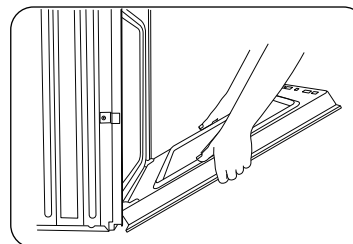

4. Partially close the door to engage the door latch locks.
The door will stop at this point.

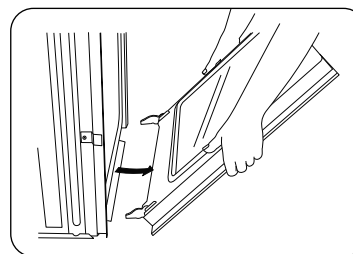

5. Using two hands, grasp the edges of the oven door. Lift and pull the oven door toward you and remove. You may need to gently shift the door from side to side as you pull.
6. Set the oven door aside on the prepared covered work surface with the oven door resting on its handle.

Replacing the oven door (Lower oven only)

⚠ CAUTION

The door is very heavy. You may need help lifting the door high enough to slide it into the hinge slots. Do not lift the door by the handle.

⚠ WARNING

You can't replace the upper oven door for safety reasons.

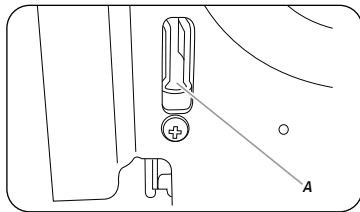

A. Slot in the oven cavity for the door hinge lock

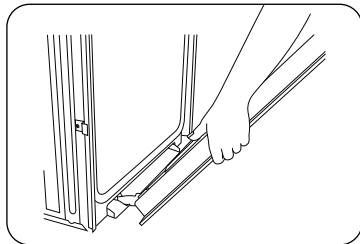

1. Using two hands, grasp the side edges of the door at the midpoint. Face the oven cavity.
2. Locate the slots on each side of the oven cavity for the door hinge locks.
3. Hold the door at a 45° angle, and then align the door hinges with the slots in the lower front of the oven cavity. Slowly insert the door, making sure you maintain the 45° angle. You will know the door is engaged in the slot when you feel a slight drop.

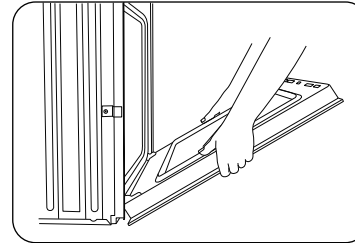

4. Lower the oven door to the fully open position. If the oven door does not open to a full 90°, repeat steps 1 through 3.
5. Locate the oven door hinge locks in the corners of the oven door, and then rotate the hinge locks toward the oven cavity to the locked position. See Step 3 (illustration A) in the “Removing the oven door” section for the proper locked position.
6. Close the oven door.
7. When the hinges are properly installed and the door is closed, there should be an even gap between the door and the control panel. If one side of the oven door is hanging lower than the other, the hinge on that side is not properly installed.

Maintaining your appliance

Changing the oven light (Lower oven only)

The oven light is a standard 40-watt appliance halogen bulb. It comes on when the oven door is open. When the oven door is closed, touch  to turn the light on or off. It will not work during a self-cleaning.

CAUTION

Before changing the oven light, make sure to wear gloves to protect your hands.

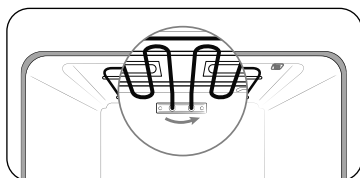

1. To change the halogen bulb, you must tilt the broil heater down. To do this, turn the circular nut on the support counterclockwise while holding the broil heater. The broil heater should loosen and tilt down.

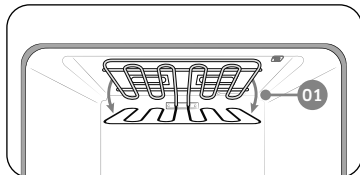

CAUTION

The broil heater is not a removable part. Do not force the broil heater down. Do not let it drop down.

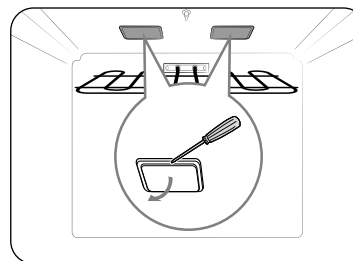

2. While holding the glass cover with one hand, insert a flat-sharp tool such as a table knife between the glass and the frame to remove the glass cover.

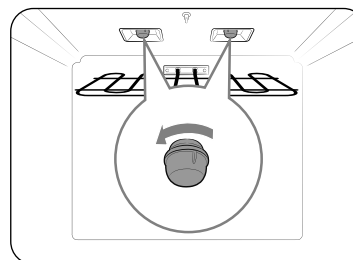

3. Turn the bulb cap counterclockwise to remove.

NOTE

If necessary, remove the metal rings and clean the bulb cap.

4. Replace the bulb.
5. Place the bulb cap and glass cover back into their position.
6. Return the broil heater back by following step 1 in reverse order.

CAUTION

Before changing your oven light, disconnect the electrical power to the oven at the main fuse or circuit breaker panel. Make sure the oven and the halogen bulb are cool.

Troubleshooting

Samsung works hard to ensure that you don't have problems with your new electric oven. If you run into unexpected trouble, look first for a solution in the tables starting below. If you're still having trouble after trying the suggested solution, call Samsung at 1-800-SAMSUNG (726-7864).

Control Display

Symptom	Possible cause	Solution
The display goes blank.	A fuse in your home may be blown or the circuit breaker tripped.	Replace the fuse or reset the circuit breaker.
The buttons cannot be pressed properly.	<ul style="list-style-type: none"> There is foreign matter caught between the buttons Touch model: There is moisture on the exterior The lock function is set 	<ul style="list-style-type: none"> Remove the foreign matter and try again. Remove the moisture and try again. Check whether the lock function is set.

For the Microwave Oven

Symptom	Cause	Action
General		
The buttons cannot be pressed properly.	Foreign matter may be caught between the buttons.	Remove the foreign matter and try again.
	For touch models: Moisture is on the exterior.	Wipe the moisture from the exterior.
	Child lock is activated.	Deactivate Child lock.
The oven does not work.	Power is not supplied.	Make sure power is supplied. Make sure the oven is plugged in. Check if a fuse has been blown or circuit breaker has been tripped.
	The door is open.	Close the door and try again.
	The door open safety mechanisms are covered in foreign matter.	Remove the foreign matter and try again.
The oven stops while in operation.	The user has opened the door to turn food over.	After turning over the food, press the Start button again to start operation.

Troubleshooting

Symptom	Cause	Action
The power turns off during operation.	The oven has been cooking for an extended period of time.	After cooking for an extended period of time, let the oven cool.
	The cooling fan is not working.	Listen for the sound of the cooling fan.
	Trying to operate the oven without food inside.	Put food in the oven.
	There is not sufficient ventilation space for the oven.	There are intake/exhaust outlets on the front and rear of the oven for ventilation. Keep the gaps specified in the product installation guide.
	Several power plugs are being used in the same socket.	Designate only one socket to be used for the oven.
There is a popping sound during operation, and the oven doesn't work.	Cooking sealed food or using a container with a lid may cause popping sounds.	Do not use sealed containers as they may burst during cooking due to expansion of the contents.
The oven exterior is too hot during operation.	There is not sufficient ventilation space for the oven.	There are intake/exhaust outlets on the front and rear of the oven for ventilation. Keep the gaps specified in the product installation guide.
	Objects are on top of the oven.	Remove all objects on the top of the oven.
The door cannot be opened properly.	Food residue is stuck between the door and oven interior.	Clean the oven and then open the door.

Symptom	Cause	Action
Heating including the Warm function does not work properly.	The oven may not work, too much food is being cooked, or improper cookware is being used.	Put one cup of water in a microwave-safe container and run the microwave for 1-2 minutes to check whether the water is heated. Reduce the amount of food and start the function again. Use a cooking container with a flat bottom.
The thaw function does not work.	Too much food is being cooked.	Reduce the amount of food and start the function again.
The interior light is dim or does not turn on.	The door has been left open for a long time.	The interior light may automatically turn off when the Eco function operates. Close and reopen the door or press the Cancel button.
	The interior light is covered by foreign matter.	Clean the inside of the oven and check again.
A beeping sound occurs during cooking.	If the Auto Cook function is being used, this beeping sound means it's time to turn over the food during thawing.	After turning over the food, press the Start button again to restart operation.
The oven is not level.	The oven is installed on an uneven surface.	Make sure the oven is installed on flat, stable surface.
There are sparks during cooking.	Metal containers are used during the oven/thawing functions.	Do not use metal containers.

Symptom	Cause	Action
When power is connected, the oven immediately starts to work.	The door is not properly closed.	Close the door and check again.
There is electricity coming from the oven.	The power or power socket is not properly grounded.	Make sure the power and power socket are properly grounded.
<ol style="list-style-type: none"> 1. Water drips. 2. Steam is emitted through a door crack. 3. Water remains in the oven. 	There may be water or steam in some cases depending on the food. This is not an oven malfunction.	Let the oven cool and then wipe with a dry dish towel.
The brightness inside the oven varies.	Brightness changes depending on power output changes according to function.	Power output changes during cooking are not malfunctions. This is not an oven malfunction.
Cooking is finished, but the cooling fan is still running.	To ventilate the oven, the cooling fan continues to run for about 3 minutes after cooking is complete.	This is not an oven malfunction.

Symptom	Cause	Action
Turntable		
While turning, the turntable comes out of place or stops turning.	There is no roller ring, or the roller ring is not properly in place.	Install the roller ring and then try again.
The turn table drags while turning.	The roller ring is not properly in place, there is too much food, or the container is too large and touches the inside of the microwave.	Adjust the amount of food and do not use containers that are too large.
The turn table rattles while turning and is noisy.	Food residue is stuck to the bottom of the oven.	Remove any food residue stuck to the bottom of the oven.
Broiling		
Smoke comes out during operation.	During initial operation, smoke may come from the heating elements when you first use the oven.	This is not a malfunction, and if you run the oven 2-3 times, it should stop.
	Food is on the heating elements.	Let the oven cool and then remove the food from the heating elements.
	Food is too close to the grill.	Put the food a suitable distance away while cooking.
	Food is not properly prepared and/or arranged.	Make sure food is properly prepared and arranged.

Troubleshooting

For the Lower Oven

Symptom	Possible cause	Solution
The oven will not turn on.	The oven is not completely plugged into the electrical outlet.	Make sure the electrical plug is inserted into a live, properly grounded outlet.
	A fuse in your home may be blown or a circuit breaker may have tripped.	Replace the fuse or reset the circuit breaker.
	The oven controls have been set improperly.	See the chapter on operating the oven starting on page 21.
	The oven is too hot.	Allow the oven to cool.
	Incomplete service wiring.	Call for service.
	Power outage.	Check to see if the house lights will turn on. If necessary, call your local electric company for service.
The oven light will not turn on.	The light is loose or defective.	<ul style="list-style-type: none"> Tighten or replace the lamp. Call for service if the door light does not turn on.
	The switch operating the light is broken.	Call for service.

Symptom	Possible cause	Solution
The oven smokes excessively during broiling.	The oven controls have not been set properly.	Refer to the section on operating the oven starting on page 21.
	The meat has been placed too close to the element.	Reposition the rack to provide proper clearance between the meat and the element. Preheat the broil element for searing.
	The meat has not been properly prepared.	Remove excess fat from the meat. Cut away fatty edges that may curl, leaving the lean intact.
	Grease has built up on oven surfaces.	Regular cleaning is necessary when broiling frequently.
	Food does not bake or roast properly.	The oven controls have not been set correctly.
Food does not bake or roast properly.	The oven rack has been positioned incorrectly or is not level.	See the section on Using the oven racks starting on page 34.
	Incorrect cookware or cookware of improper size is being used.	
	The oven temperature needs to be adjusted.	See the Temp Adjust section on page 38.

Symptom	Possible cause	Solution
Food does not broil properly.	The serving size may not be appropriate.	Refer to the Broiling recommendation guide for serving sizes on page 36, and then try again.
	The rack has not been properly positioned.	See the Broiling recommendation guide on page 36.
	The cookware is not suited for broiling.	Use suitable cookware.
	In some areas, the power (voltage) may be low.	<ul style="list-style-type: none"> Preheat the broil element for 10 minutes. See the Broiling recommendation guide on page 36.
The oven temperature is too hot or too cold.	The oven temperature needs to be adjusted.	See the section on adjusting the temperature on page 38.
There is water dripping.	You may see water or steam in some cases depending on the food you are cooking. This is not a product malfunction.	Let the oven cool and then wipe with a dry dish towel.
There is steam coming through the crack between the oven body and the door.		
Water is remaining in the oven.		

Symptom	Possible cause	Solution
The oven will not self-clean.	The oven temperature is too high to start a self-clean operation.	Allow the oven to cool and then reset the controls.
	The oven controls have been set incorrectly.	See the section on Self-cleaning on page 42.
	A self-cleaning cycle cannot be started if the oven lockout feature has been activated.	Deactivate the oven lockout (see page 23).
Excessive smoking during a self-cleaning cycle.	There is excessive soiling in the oven.	Touch OVEN OFF . Open the windows to rid the room of smoke. Wait until the self-cleaning cycle is cancelled. Wipe up the excessive soil and then start the self-cleaning cycle again.
The oven door will not open after a self-cleaning cycle.	The oven is too hot.	Allow the oven to cool.
The oven is not clean after a self-cleaning cycle.	The oven controls were not set correctly.	See the section on Self-cleaning on page 42.
	The oven was heavily soiled.	Wipe up heavy spillovers before starting the self-cleaning cycle. Heavily soiled ovens may need to be self-cleaned again or for a longer period of time.

Troubleshooting

Symptom	Possible cause	Solution
A burning or oily odor is coming from the vent.	This is normal for a new oven and will disappear in time.	<ul style="list-style-type: none"> To speed the process, set a self-cleaning cycle for a minimum of 3 hours. See the section on Self-cleaning on page 42.
Strong odor.	An odor coming from the insulation around the inside of the oven is normal for the first few times the oven is used.	Operate the oven empty on the bake setting at 400 °F for 1 hour.
The oven racks are difficult to slide.	The shiny, silver-colored racks were cleaned in a self-cleaning cycle.	Apply a small amount of vegetable oil to a paper towel, and then wipe the edges of the oven racks with the paper towel.
The oven door is locked.	The circuit breaker has been tripped or there was a power failure while the oven door was locked.	Activate Control Lockout, and then unlock the control. See the Control Lockout section on page 23.

Information codes

Displayed Code	Possible cause	Solution
C-d0	This code occurs if the control key is short for 1 minute.	Clean the buttons and make sure there is no water on/ around them. Turn off the oven and try again. If the problem continues, contact a local Samsung service center.
C-d1	This code occurs if the door lock is mispositioned.	Touch OVEN OFF , and then restart the oven. If the problem persists, disconnect all power to the oven for at least 30 seconds and then reconnect the power. If this does not solve the problem, call for service.
C-F0	This code occurs if communication between the Main and Sub PBA is interrupted.	
C-F2	This code occurs if communication between the Main and Touch is interrupted.	
C-10	The cooking sensor is open when the microwave is operating.	
	The cooking sensor is short when the microwave is operating.	
C-20	The oven sensor is open when the oven is operating.	
	The oven sensor is short when the oven is operating.	

Displayed Code	Possible cause	Solution
C-21	This code occurs if the internal temperature rises abnormally high.	Touch OVEN OFF , and then restart the oven. If the problem persists, disconnect all power to the oven for at least 30 seconds and then reconnect the power. If this does not solve the problem, call for service.
C-30	The PCB sensor is open when the oven is operating.	
	The PCB sensor is short when the oven is operating.	
C-31	This code occurs if the PCB temperature rises abnormally high.	Call for service
C-A2	The cooling motor is operating abnormally.	Call for service.
bAd LinE	This code occurs if the power connection is plugged in improperly.	Reconnect the power connection properly, and the message disappears.

Warranty (USA)

SAMSUNG MICROWAVE OVEN

LIMITED WARRANTY TO ORIGINAL PURCHASER WITH PROOF OF PURCHASE

This SAMSUNG brand product, as supplied and distributed by SAMSUNG ELECTRONICS AMERICA, INC. (SAMSUNG) and delivered new, in the original carton to the original consumer purchaser, is warranted by SAMSUNG against manufacturing defects in materials or workmanship for the limited warranty period, starting on the date of delivery to the original consumer purchaser, of:

One (1) Year Parts and Labor

Ten (10) Years Magnetron Part (Part Only)

This limited warranty is valid only on products purchased and used in the United States that have been installed, operated, and maintained according to the instructions attached to or furnished with the product. To receive warranty service, the purchaser must contact SAMSUNG at the address or phone number provided below for problem determination and service procedures. Warranty service can only be performed by a SAMSUNG authorized service center. The original dated bill of sale and/or proof of delivery must be presented upon request as proof of purchase to SAMSUNG or SAMSUNG's authorized service center to receive warranty service.

SAMSUNG will provide in-home service within the contiguous United States during the warranty period at no charge, subject to availability of SAMSUNG authorized servicers within the customer's geographic area. If in-home service is not available, SAMSUNG may elect, at its option, to provide transportation of the product to and from an authorized service center. If the product is located in an area where service by a SAMSUNG authorized servicer is not available, you may be responsible for a trip charge or required to bring the product to a SAMSUNG authorized service center for service.

To receive in-home service, product must be unobstructed and accessible to the service agent.

Warranty (USA)

During the applicable warranty period, a product will be repaired, replaced, or the purchase price refunded, at the sole option of SAMSUNG. SAMSUNG may use new or reconditioned parts in repairing a product, or replace the product with a new or reconditioned product. Replacement parts and products are warranted for the remaining portion of the original product's warranty or ninety (90) days, whichever is longer. All replaced parts and products are the property of SAMSUNG and you must return them to SAMSUNG.

This limited warranty covers manufacturing defects in materials or workmanship encountered in normal household, noncommercial use of this product and shall not cover the following: damage that occurs in shipment, delivery, installation, and uses for which this product was not intended; damage caused by unauthorized modification or alteration of the product; product where the original factory serial numbers have been removed, defaced, changed in any way, or cannot be readily determined; cosmetic damage including scratches, dents, chips, and other damage to the product's finishes; damage caused by abuse, misuse, overheating due to overcooking, glass tray or turntable, pest infestations, accident, fire, floods, or other acts of nature or God; damage caused by use of equipment, utilities, services, parts, supplies, accessories, applications, installations, repairs, external wiring or connectors not supplied or authorized by SAMSUNG; damage caused by incorrect electrical line current, voltage, fluctuations and surges; damage caused by failure to operate and maintain the product according to instructions; in-home instruction on how to use your product; service to correct installation not in accordance with electrical or plumbing codes or correction of household electrical or plumbing (i.e., house wiring, fuses, or water inlet hoses); and reduced magnetron power output related to normal aging.

The cost of repair or replacement under these excluded circumstances shall be the customer's responsibility.

Visits by an authorized servicer to explain product functions, maintenance or installation are not covered by this limited warranty. Please contact SAMSUNG at the number below for assistance with any of these issues.

Samsung will charge a repair fee for replacing an accessory or repairing cosmetic damage if the damage to the unit and/or damage to or loss of the accessory was caused by the customer. Items this covers include:

- Dented, scratched, or broken door, handle, out-panel, or control panel
- Broken or lost tray, guide roller, coupler, filter, or wire rack

Parts that SAMSUNG has determined can be replaced by the user may be sent to the customer for installation. In SAMSUNG's discretion, an authorized servicer can be dispatched to perform such installation.

EXCLUSION OF IMPLIED WARRANTIES

IMPLIED WARRANTIES, INCLUDING THE IMPLIED WARRANTIES OF MERCHANTABILITY OR FITNESS FOR A PARTICULAR PURPOSE, ARE LIMITED TO ONE YEAR OR THE SHORTEST PERIOD ALLOWED BY LAW. Some states do not allow limitations on how long an implied warranty lasts, so the above limitations or exclusions may not apply to you. This warranty gives you specific rights, and you may also have other rights, which vary from state to state.

LIMITATION OF REMEDIES

YOUR SOLE AND EXCLUSIVE REMEDY IS PRODUCT REPAIR, PRODUCT REPLACEMENT, OR REFUND OF THE PURCHASE PRICE AT SAMSUNG'S OPTION, AS PROVIDED IN THIS LIMITED WARRANTY. SAMSUNG SHALL NOT BE LIABLE FOR SPECIAL, INCIDENTAL OR CONSEQUENTIAL DAMAGES, INCLUDING BUT NOT LIMITED TO TIME WAY FROM WORK, HOTELS AND/OR RESTAURANT MEALS, REMODELING EXPENSES, LOSS OF REVENUE OR PROFITS, FAILURE TO REALIZE SAVINGS OR OTHER BENEFITS REGARDLESS OF THE LEGAL THEORY ON WHICH THE CLAIM IS BASED, AND EVEN IF SAMSUNG HAS BEEN ADVISED OF THE POSSIBILITY OF SUCH DAMAGES. Some states do not allow exclusion or limitation of incidental or consequential damages, so the above limitations or exclusions may not apply to you. This warranty gives you specific rights, and you may also have other rights, which vary from state to state.

SAMSUNG does not warrant uninterrupted or error-free operation of the product. No warranty or guarantee given by any other person, firm, or corporation with respect to this product shall be binding on SAMSUNG.

To obtain warranty service, please contact SAMSUNG at:
Samsung Electronics America, Inc.
85 Challenger Road
Ridgefield Park, NJ 07660

1-800-SAMSUNG (726-7864) and www.samsung.com/us/support

Warranty (CANADA)

PLEASE DO NOT DISCARD. THIS PAGE REPLACES THE WARRANTY PAGE IN THE USE & CARE GUIDE

SAMSUNG MICROWAVE OVEN

LIMITED WARRANTY TO ORIGINAL PURCHASER

This SAMSUNG brand product, as supplied and distributed by SAMSUNG ELECTRONICS CANADA, INC. (SAMSUNG) and delivered new, in the original carton to the original consumer purchaser, is warranted by SAMSUNG against manufacturing defects in materials and workmanship for a limited warranty period of:

ONE (1) YEAR PARTS AND LABOR, FIVE (5) YEARS PARTS WARRANTY FOR MAGNETRON

This limited warranty begins on the original date of purchase, and is valid only on products purchased and used in the CANADA. To receive warranty service, the purchaser must contact SAMSUNG for problem determination and service procedures. Warranty service can only be performed by a SAMSUNG authorized service center. The original dated bill of sale must be presented upon request as proof of purchase to SAMSUNG or SAMSUNG's authorized service center. Samsung will provide in-home service during the warranty period at no charge subject to availability within the contiguous CANADA. In home service is not available in all areas. To receive in home service, the product must be unobstructed and accessible to the service agent. If service is not available Samsung may elect to provide transportation of the product to and from an authorized service center.

SAMSUNG will repair or replace this product, at our option and at no charge as stipulated herein, with new or reconditioned parts or products if found to be defective during the limited warranty period specified above. All replaced parts and products become the property of SAMSUNG and must be returned to SAMSUNG. Replacement parts and products assume the remaining original warranty, or ninety (90) days, whichever is longer. This limited warranty covers manufacturing defects in materials and workmanship encountered in normal, noncommercial use of this product and shall not apply to the following: damage which occurs in shipment; delivery and installation; applications and uses for which this product was not intended; altered product or serial numbers; cosmetic damage or exterior finish; accidents, abuse, neglect, fire, water, lightning or other acts of nature; use of products, equipment, systems, utilities, services, parts, supplies, accessories, applications, installations, repairs, external wiring or connectors not supplied or authorized by SAMSUNG which damage this product or result in service problems; incorrect electrical line voltage, fluctuations and surges; customer adjustments and failure to follow operating instructions, maintenance and environmental instructions that are covered and prescribed in the instruction book; product removal and reinstallation; problems caused by pest infestations, and overheating or overcooking by user. This limited warranty shall not cover cases of incorrect electric current, voltage or supply, light bulbs, house fuses, house wiring, cost of a service call for instructions, or fixing installation errors. SAMSUNG does not warrant uninterrupted or error-free operation of the product.

Warranty (CANADA)

EXCEPT AS SET FORTH HEREIN THERE ARE NO WARRANTIES ON THIS PRODUCT EITHER EXPRESS OR IMPLIED AND SAMSUNG DISCLAIMS ALL WARRANTIES INCLUDING, BUT NOT LIMITED TO, ANY IMPLIED WARRANTIES OF MERCHANTABILITY, INFRINGEMENT OR FITNESS FOR A PARTICULAR PURPOSE. NO WARRANTY OR GUARANTY GIVEN BY ANY PERSON, FIRM OR CORPORATION WITH RESPECT TO THIS PRODUCT SHALL BE BINDING ON SAMSUNG. SAMSUNG SHALL NOT BE LIABLE FOR LOSS OF REVENUE OR PROFITS, FAILURE TO REALIZE SAVINGS OR OTHER BENEFITS, OR ANY OTHER SPECIAL, INCIDENTAL OR CONSEQUENTIAL DAMAGES CAUSED BY THE USE, MISUSE OR INABILITY TO USE THIS PRODUCT, REGARDLESS OF THE LEGAL THEORY ON WHICH THE CLAIM IS BASED, AND EVEN IF SAMSUNG HAS BEEN ADVISED OF THE POSSIBILITY OF SUCH DAMAGES. NOR SHALL RECOVERY OF ANY KIND AGAINST SAMSUNG BE GREATER IN AMOUNT THAN THE PURCHASE PRICE OF THE PRODUCT SOLD BY SAMSUNG AND CAUSING THE ALLEGED DAMAGE. WITHOUT LIMITING THE FOREGOING, PURCHASER ASSUMES ALL RISK AND LIABILITY FOR LOSS, DAMAGE OR INJURY TO PURCHASER AND PURCHASER'S PROPERTY AND TO OTHERS AND THEIR PROPERTY ARISING OUT OF THE USE, MISUSE OR INABILITY TO USE THIS PRODUCT. THIS LIMITED WARRANTY SHALL NOT EXTEND TO ANYONE OTHER THAN THE ORIGINAL PURCHASER OF THIS PRODUCT, IS NONTRANSFERABLE AND STATES YOUR EXCLUSIVE REMEDY.

Some states do not allow limitations on how long an implied warranty lasts, or the exclusion or limitation of incidental or consequential damages, so the above limitations or exclusions may not apply to you. This warranty gives you specific legal rights, and you may also have other rights which vary from state to state.

To obtain warranty service, please contact SAMSUNG at:

Samsung Electronics Canada Inc.
2050 Derry Road West, Mississauga, Ontario L5N 0B9 Canada
1-800-SAMSUNG (726-7864) and www.samsung.com/ca/support (English)
www.samsung.com/ca_fr/support (French)

Appendix

Open Source Announcement

The software included in this product contains open source software. You may obtain the complete corresponding source code for a period of three years after the last shipment of this product by sending an email to <mailto:oss.request@samsung.com>.

It is also possible to obtain the complete corresponding source code in a physical medium such as a CD-ROM; a minimal charge will be required.

The following URL <http://opensource.samsung.com/opensource/SimpleConnectTP/seq/0> leads to the download page of the source code made available and open source license information as related to this product. This offer is valid to anyone in receipt of this information.



Memo



Scan this with your smartphone

Scan the QR code* or visit
www.samsung.com/spsn
to view our helpful
How-to Videos and Live Shows

* Requires reader to be installed on your
smartphone

Please be advised that the Samsung warranty does NOT cover service calls to explain product operation, correct improper installation, or perform normal cleaning or maintenance.

QUESTIONS OR COMMENTS?

COUNTRY	CALL	OR VISIT US ONLINE AT
U.S.A Consumer Electronics	1-800-SAMSUNG (726-7864)	www.samsung.com/us/support
CANADA	1-800-SAMSUNG (726-7864)	www.samsung.com/ca/support (English) www.samsung.com/ca_fr/support (French)

