

# Electric Range

---

User manual

NE63\*671\*S\*

---



**SAMSUNG**

## Anti-tip device

---



### WARNING

To reduce the risk of tipping the range, the range must be secured by a properly installed Anti-Tip device. **AFTER THE RANGE HAS BEEN INSTALLED, CONFIRM THAT THE ANTI-TIP DEVICE HAS BEEN PROPERLY INSTALLED AND VERIFY THAT THE ANTI-TIP DEVICE IS PROPERLY ENGAGED.** Refer to the installation manual for instructions.

- a) If the Anti-Tip device is not installed, a child or adult can tip the range and be killed.
- b) Verify that the Anti-Tip device has been properly installed and engaged at the rear right (or rear left) of the range bottom.
- c) If you move the range and then move it back into place, ensure the Anti-Tip device is re-engaged at the right or left rear of the range bottom.
- d) Do not operate the range without the Anti-Tip device in place and engaged.
- e) Failure to do so can result in death or serious burns to children or adults.



### WARNING

-  **Do not step, lean, or sit on the doors of the range.** You can cause the range to tip, resulting in burns or serious injuries.
-  Confirm that the Anti-Tip device is installed properly. Then, to verify that the Anti-Tip device is engaged, grasp the top rear edge of the range and carefully attempt to tilt it forward. The Anti-Tip device should prevent the range from tilting forward more than a few inches. If you pull the range out from the wall for any reason, make sure the Anti-Tip device is properly engaged when you push the range back against the wall. If it is not, there is a risk of the range tipping over and causing injury if you or a child stand, sit, or lean on the open door. Never completely remove the leveling legs. If you remove the leveling legs, the range will not be secured to the Anti-Tip device properly.

# Regulatory Notice

---

## 1. FCC NOTICE

This equipment has been tested and found to comply with the limits for a Class B digital device, pursuant to part 15 of the FCC Rules. These limits are designed to provide reasonable protection against harmful interference in a residential installation. This equipment generates, uses and can radiate radio frequency energy and, if not installed and used in accordance with the instructions, may cause harmful interference to radio communications. However, there is no guarantee that interference will not occur in a particular installation. If this equipment does cause harmful interference to radio or television reception, which can be determined by turning the equipment off and on, the user is encouraged to try to correct the interference by one or more of the following measures:

- Reorient or relocate the receiving antenna.
- Increase the separation between the equipment and receiver.

- Connect the equipment into an outlet on a circuit different from that to which the receiver is connected. z
- Consult the dealer or an experienced radio/TV technician for help.

To satisfy FCC RF exposure requirements, a separation distance of 20 cm or more should be maintained between the antenna of this device and persons during device operation.

To ensure compliance, operations at closer than this distance is not recommended.

### **WARNING**

Any changes or modifications to this unit not expressly approved by the party responsible for compliance could void the user's authority to operate the equipment.

---

## 2. IC Notice

The term “IC” before the radio certification number only signifies that Industry Canada technical specifications were met. Operation is subject to the following two conditions: (1) this device may not cause interference, and (2) this device must accept any interference, including interference that may cause undesired operation of the device.

This Class B digital apparatus complies with Canadian ICES-003. For products available in the US/Canadian markets, only channels 1~11 are available. You cannot select any other channels.

---

## IC RADIATION EXPOSURE STATEMENT:

This equipment complies with IC RSS-102 radiation exposure limits set forth for an uncontrolled environment. This equipment should be installed and operated so there is at least 8 inches (20 cm) between the radiator and your body. This device and its antenna(s) must not be co-located or operated in conjunction with any other antenna or transmitter.

# Contents

<b>Important safety instructions</b>	<b>6</b>		
What you need to know about safety instructions	6	Setting the kitchen timer	29
California Proposition 65 Warning	6	Timed cooking	30
For your safety	7	Delay start	30
Surface cooking units	9	Turning the oven light on and off	30
Electrical safety	10	Minimum and maximum settings	31
Child safety	11	Using the oven racks	31
Oven	11	Baking	33
Remote Operation	12	Convection baking	33
Self-cleaning ovens	13	Convection roasting	34
Ventilating hood	13	Broiling	35
Glass/Ceramic cooking surfaces	14	Air fry	36
Critical installation warnings	14	Using the special function	37
Critical usage warning	15	Using the keep warm feature	38
Usage cautions	18	Using the smart control feature	38
Critical cleaning warnings	20	Using the voice control	39
		Using the options function	40
		Using the Sabbath feature	42
<b>Introducing your new range</b>	<b>21</b>	<b>Maintaining your appliance</b>	<b>44</b>
Overview	21	Self-cleaning	44
What's included	21	Steam-cleaning	46
		Care and cleaning of the oven	47
<b>Before you begin</b>	<b>22</b>	Care and cleaning of the glass cooktop	49
Energy saving tips	22	Removing and reinstalling the oven door	51
		Removing and reinstalling the storage drawer	52
<b>Surface cooking</b>	<b>22</b>	Changing the oven light	53
About surface cooking	22		
How to set the appliance for surface cooking	24	<b>Troubleshooting</b>	<b>53</b>
Using the proper cookware	26	Troubleshooting	53
Choosing the proper cookware	27	Information codes	58
Griddle	27		
Protecting the cooktop	28	<b>Warranty (U.S.A)</b>	<b>59</b>
<b>Operating the oven</b>	<b>28</b>	<b>Warranty (CANADA)</b>	<b>60</b>
The oven control panel	28		
Oven lock	29	<b>Appendix</b>	<b>62</b>
Setting the clock	29	Open Source Announcement	62

## Important safety instructions

---

Read and follow all instructions before using your range to prevent the risk of fire, electric shock, personal injury, or damage when using the range. This guide does not cover all possible conditions that may occur. Always contact your service agent or the manufacturer about problems that you do not understand.

## WHAT YOU NEED TO KNOW ABOUT SAFETY INSTRUCTIONS

---

Warnings and Important safety instructions in this manual do not cover all possible conditions and situations that may occur. It is your responsibility to use common sense, caution, and care when installing, maintaining, and operating your oven.

### Important safety symbols and precautions

What the icons and signs in this user manual mean:

#### **WARNING**

Hazards or unsafe practices that may result in **severe personal injury or death**.









#### **CAUTION**

Hazards or unsafe practices that may result in **minor personal injury or property damage**.

## SAVE THESE INSTRUCTIONS

#### **CAUTION**

To reduce the risk of fire, explosion, electric shock, or personal injury when using your range, follow these basic safety precautions.

-  Do NOT attempt.
-  Do NOT disassemble.
-  Do NOT touch.
-  Follow directions explicitly.
-  Unplug the power plug from the wall socket.
-  Make sure the machine is grounded to prevent electric shock.
-  Call a Samsung service center for help.
-  Note

These warning signs are here to prevent injury to you and others. Please follow them explicitly.

After reading this section, keep it in a safe place for future reference.

## CALIFORNIA PROPOSITION 65 WARNING

---

#### **WARNING**

Cancer and Reproductive Harm - [www.P65Warnings.ca.gov](http://www.P65Warnings.ca.gov).



---

## FOR YOUR SAFETY

---

When using electrical appliances, you should follow basic safety precautions, including the following:

### CAUTION

- Use this appliance only for its intended purpose as described in this Owner's Manual.
- Potentially hot surfaces include the cooktop, areas facing the cooktop, the oven vent opening, surfaces near the opening, and crevices around the oven door.
-  Be sure your appliance is properly installed and grounded by a qualified technician.
-  **User servicing** - Do not repair or replace any part of the appliance unless specifically recommended in this manual. All other servicing should be referred to a qualified technician.
-  Always disconnect the power to the appliance before servicing by removing the fuse or switching off the circuit breaker.

-  • **Do not enter the oven.**
- **Do not store items of interest to children in cabinets above the range or on the back guard of the range.** Children climbing on the range to reach items could be seriously injured.
- **Do not leave children alone.** Never leave children alone or unattended in an area where this appliance is in use. They should never be allowed to sit or stand on any part of the appliance.
- **Never use your appliance for warming or heating the room.**
- **Do not use water on grease fires.** Turn off the oven to avoid spreading the flames. Smother the fire or flames by closing the door or use a dry chemical, baking soda, or foam-type extinguisher.
- Avoid scratching or striking the glass doors, the cooktop, or the control panel. Doing so may lead to glass breakage. Do not cook on a product with broken glass. Shock, fire, or cuts may occur.

## SAVE THESE INSTRUCTIONS

## Important safety instructions

---

- ☐ • If there is a fire in the oven during self-cleaning, turn the oven off and wait for the fire to go out. Do not force the door open. The introduction of fresh air at self-cleaning temperatures may lead to a burst of flame from the oven. Failure to follow these instructions may result in severe burns.
- If the oven is heavily soiled with oil, self-clean the oven before using the oven again. Leaving the oil in place creates a risk of fire.
- Wipe up heavy soil on the oven bottom with a paper towel or rag before self-cleaning. Self-cleaning the oven when there is heavy soil on the oven bottom requires longer cleaning cycles and produces more smoke.
- ★ • **Storage in or on the appliance.** Do not store flammable materials in the oven or near the surface units. Be sure all packing materials are removed from the appliance before operating it. Keep plastics, clothes, and paper away from parts of the appliance that may become hot.
- **Wear proper apparel.** Never wear loose-fitting or hanging garments while using the appliance.

- ★ • **Use only dry potholders.** Placing moist or damp potholders on hot surfaces may result in burns from steam. Do not let the potholder touch hot heating elements. Do not use a towel or other bulky cloth.
- Teach children not to play with the controls or any other part of the range.
- For your safety, do not use high-pressure water cleaners or steam jet cleaners to clean any part of the range.
- If the power cord is damaged, it must be replaced by the manufacturer, its service agent, or similarly qualified persons to avoid creating a hazard.
- The appliance is not intended for use by persons (including children) with reduced physical, sensory or mental capabilities, or lack of experience and knowledge, unless they have been given supervision or instruction concerning use of the appliance by a person responsible for their safety.
- Do not lean on the range as you may turn the control knobs inattentively.

## SAVE THESE INSTRUCTIONS



---

## SURFACE COOKING UNITS

---

- ☒ • **Never leave surface units unattended at high heat settings.** Boilovers cause smoking and greasy spillovers that may ignite.
  - Protective Liners – Do not use aluminum foil to line surface unit drip bowls or oven bottoms, except as suggested in the manual. Improper installation of these liners may result in a risk of electric shock or fire.
  - To avoid oil spillover and fire, use a minimum amount of oil when shallow pan-frying and avoid cooking frozen foods that have excessive amounts of ice.
  - **Do not lift the cooktop.** Lifting the cooktop can damage the range and cause the range to malfunction.
  - **Do not operate the cooktop without cookware.** If the cooktop operates without cookware, the control knobs will become hot.
  - Never use the glass cooktop surface as a cutting board.
- ★ • **Use care when touching the cooktop.** The glass surface of the cooktop will retain heat after the controls have been turned off.
  - Do not move the container and bowl in a horizontal position on cooktop surface.
- ★ • **Be careful when placing spoons or other stirring utensils on the glass cooktop surface when it is in use.** They may become hot and could cause burns.
- **Use proper pan sizes.** This appliance is equipped with surface units of different size. Select pots and pans that have flat bottoms large enough to cover the surface area of the heating element. Using undersized cookware will expose a portion of the heating element to direct contact and may result in the ignition of clothing. Matching the size of the pot or pan to the burner will also improve efficiency.
- **Cookware Handles Should Be Turned Inward and Not Extend Over Adjacent Surface Units.** To reduce the risk of burns, ignition of flammable materials, or spillage due to unintentional contact with cookware, position cookware handles so that they are turned inward and do not extend over adjacent surface units.
- **Glazed cookware.** Only certain types of glass, glass/ceramic, ceramic, earthenware, or other glazed cookware can be used for rangetop service without breaking due to sudden changes in temperature.
- **Cleaning.** Read and follow all instructions and warnings on the cleaning cream labels.

## SAVE THESE INSTRUCTIONS

## Important safety instructions

---

- ★ • Be sure you know which control knob operates each surface unit. Make sure you turned on the correct surface unit.
- Always turn the surface units off before removing cookware.
- When preparing flaming foods under the hood, turn the fan on.
- Keep an eye on foods being fried at high or medium high heat settings.
- **Do not store heavy items above the cooktop surface that could fall and damage it.**
- **Do not use decorative surface element covers** - If an element is accidentally turned on, the decorative cover will become hot and possibly melt. Burns will occur if the hot covers are touched. Damage may also be done to the cooktop.

## ELECTRICAL SAFETY

---

- ★ • **Proper Installation** - Be sure your appliance is properly installed and grounded by a qualified technician.
- The appliance should be serviced only by qualified service personnel. Repairs carried out by unqualified individuals may cause injury or a serious malfunction. If your appliance is in need of repair, contact a Samsung authorized service center. Failure to follow these instructions may result in damage and void the warranty.

## SAVE THESE INSTRUCTIONS

- ★ • Flush-mounted appliances may be operated only after they have been installed in cabinets and workplaces that conform to the relevant standards. This ensures that the appliances are installed in compliance with the appropriate safety standards.
- If your appliance malfunctions or if fractures, cracks, or splits appear:
  - switch off all cooking zones.
  - unplug the range from the AC wall outlet.
  - contact your local Samsung service center.

### **WARNING**

If the surface is cracked, switch off and unplug the appliance to avoid the possibility of electrical shock. Do not use your cooktop until the glass surface has been replaced.

### **WARNING**

- Ensure that the appliance is switched off before replacing the lamp to avoid the possibility of electric shock.
- The range should not be placed on a base.

---

## CHILD SAFETY

---

### WARNING

- This appliance is not intended for use by young children or infirm persons without the adequate supervision of a responsible adult.
- Young children should be supervised to ensure that they do not play with the appliance.
- Keep children away from the door when opening or closing it as they may bump themselves on the door or catch their fingers in the door.
- The cooking zones will become hot when you cook. To keep small children from being burned, always keep them away from the appliance while you are cooking.
- During self-cleaning, the surfaces may get hotter than usual. Keep small children away from the range when it is in the self-cleaning mode.



### WARNING

Accessible parts may become hot during use. To avoid burns, young children should be kept away.

---

## OVEN

---

-  • **DO NOT TOUCH THE HEATING ELEMENTS OR INTERIOR SURFACES OF THE OVEN.** Heating elements may be hot even though they are dark in color. Interior surfaces of an oven become hot enough to cause burns. During and after use, do not touch or let clothing or other flammable materials contact the heating elements or interior surfaces of the oven until they have had sufficient time to cool. Other surfaces of the appliance may become hot enough to cause burns. Among these surfaces are oven vent openings and surfaces near these openings, the oven door, and the window of the oven door.
- **Do not heat unopened food containers.** The build-up of pressure may cause the container to burst and result in injury.
-  • **Do not use the oven to dry newspapers.** If overheated, newspapers can catch on fire.
- **Do not use the oven for a storage area.** Items stored in an oven can ignite.

## SAVE THESE INSTRUCTIONS

## Important safety instructions

---

- ★ • **Use care when opening the door.** Let hot air or steam escape before you remove food from or put food into the oven.
- **Protective liners.** Do not use aluminum foil to line the oven bottoms, except as suggested in the manual. Improper installation of these liners may result in a risk of electric shock or fire.
- **Keep oven vent ducts unobstructed.** The oven vent is located above the right rear surface unit. This area could become hot during oven use. Never block this vent or place plastic or heat-sensitive items on it.
- **Placement of oven racks.** Always place oven racks in the desired location while the oven is cool. If the rack must be moved while the oven is hot, use potholders. Do not let the potholders come in contact with the hot heating element in the oven.
- ☐ • Do not allow aluminum foil or a meat probe to contact the heating elements.
- ☐ • **During use, the appliance becomes hot.** Care should be taken to avoid touching heating elements inside the oven.
- Do not use harsh abrasive cleaners or sharp metal scrapers to clean the oven door glass. They can scratch the surface, which may result in the glass shattering.

## SAVE THESE INSTRUCTIONS

### CAUTION

**Do not attempt to operate the oven during a power failure.** If the power fails, always turn the oven off. If the oven is not turned off and the power returns, the oven may begin to operate again. Food left unattended could catch fire or spoil.

## REMOTE OPERATION

---

This appliance is configurable to allow remote operation at any time.

- ☐ • **Do not store any flammable materials or temperature sensitive items inside, on top, or near surface units of the appliance.**

---

## SELF-CLEANING OVENS

---

- ☒ **Do not clean the door gasket.** The door gasket is essential for a good seal. Care should be taken not to rub, damage, or move the gasket.
- ★ • **Never keep pet birds in the kitchen.** Birds are extremely sensitive to the fumes released during an oven self-clean cycle. Fumes may be harmful or fatal to birds. Move birds to a well-ventilated room.
- ★ • **Clean only the parts listed in this manual in the self-clean cycle.** Before self-cleaning the oven, remove the partition, rack, utensils, and any food.
  - Before operating the self-clean cycle, wipe grease and food soils from the oven. Excessive amounts of grease may ignite, leading to smoke damage to your home.
  - Do not use any commercial oven cleaner or oven liner protective coating of any kind in or on the outside of the oven.
  - Remove the nickel oven shelves from the oven before you begin the self-cleaning cycle or they may discolor.
  - If the self-cleaning mode malfunctions, turn the oven off and disconnect the power supply. Have it serviced by a qualified technician.
  - Excess spillage must be removed before you run the self-cleaning cycle.

- Opening a window or turning on a ventilation fan or hood is recommended during and after self-cleaning.

---

## VENTILATING HOOD

---

- ★ • **Clean ventilating hoods frequently.** Do not let grease accumulate on the hood or filter.
- **When flaming foods under the hood, turn the fan on.**

**SAVE THESE INSTRUCTIONS**

## Important safety instructions

---

### GLASS/CERAMIC COOKING SURFACES

- ☐ • **DO NOT TOUCH SURFACE UNITS OR AREAS NEAR UNITS.** Surface units may be hot even though they are dark in color. Areas near surface units may become hot enough to cause burns. During and after use, do not touch, let clothing, or other flammable materials contact the surface units or areas near the units until they have had sufficient time to cool. Among these areas are the cooktop and the facing of the cooktop.
- **Do not cook on a broken cooktop.** If the cooktop should break, cleaning solutions and spillovers may penetrate the broken cooktop and create a risk of electric shock. Contact a qualified technician immediately.
- ★ **Clean the cooktop with caution.** If a wet sponge or cloth is used to wipe spills on a hot cooking area, be careful to avoid steam burns. Some cleaners can produce noxious fumes if applied to a hot surface.





### CRITICAL INSTALLATION WARNINGS

---

#### ⚠ WARNING

- ★ • This appliance must be installed by a qualified technician or service company.
  - Failing to have a qualified technician install the range may result in electric shock, fire, an explosion, problems with the product, or injury.
- Unpack the oven, remove all packaging material and examine the oven for any damage, such as dents on the interior or exterior of the oven, broken door latches, cracks in the door, or a door that is not lined up correctly. If there is any damage, do not operate the oven and notify your dealer immediately.
- Plug the power cord into a properly grounded outlet with the proper configuration. Your oven should be the only item connected to this circuit.
- Keep all packaging materials out of the reach of children. Children may use them for play and injure themselves.
- ★ • Install your appliance on a hard, level floor that can support its weight.
  - Failing to do so may result in abnormal vibrations, noise, or problems with the product.

## SAVE THESE INSTRUCTIONS

- 
-  • This appliance must be properly grounded.
  - Do not ground the appliance to a gas pipe, plastic water pipe, or telephone line.
    - This may result in electric shock, fire, an explosion, or problems with the product.
  - Do not cut or remove the ground prong from the power cord under any circumstances.
  - Connect the oven to a circuit that provides the correct amperage.
  -  • Do not install this appliance in a humid, oily or dusty location, or in a location exposed to direct sunlight or water (rain drops).
    - This may result in electric shock or fire.
  - Do not use a damaged power cord or loose wall socket.
    - This may result in electric shock or fire.
  - Do not pull or excessively bend the power cord.
  - Do not twist or tie the power cord.
  -  • Do not hook the power cord over a metal object, place a heavy object on the power cord, or insert the power cord between objects.
    - This may result in electric shock or fire.
  -  If the power cord is damaged, contact your nearest Samsung service center.

---

## CRITICAL USAGE WARNING

---

### CAUTION

-  • If the appliance is flooded by any liquid, please contact your nearest Samsung service center. Failing to do so may result in electric shock or fire.
- If the appliance produces a strange noise, a burning smell, or smoke, unplug the power plug immediately and contact your nearest Samsung service center.
  - Failing to do so may result in electric shock or fire
- In the event of a gas leak (such as propane gas, LP gas, etc.), ventilate the area immediately. Do not touch the power cord. Do not touch the appliance.
  - A spark may result in an explosion or fire.

**SAVE THESE INSTRUCTIONS**

## Important safety instructions

---

- ★ • Take care not to contact the oven door, heating elements, or any of the other hot parts with your body while cooking or just after cooking.
  - Failing to do so may result in burns.
- If materials inside the oven should ignite, keep the oven door closed, turn the oven off and disconnect the power cord, or shut off power at the fuse or circuit breaker panel. If the door is opened, the fire may spread.
- Always observe safety precautions when using your oven. Never try to repair the oven on your own - there is dangerous voltage inside. If the oven needs to be repaired, contact an authorized Samsung service center near you.
- If you use the appliance when it is contaminated by foreign substance, such as food waste, it may result in a problem with the appliance.
- Take care when removing the wrapping from food taken out of the appliance.
  - If the food is hot, hot steam may be emitted abruptly when you remove the wrapping and this may result in burns.

- ☒ • Do not attempt to repair, disassemble, or modify the appliance yourself.
  - Since a high voltage current enters the product chassis, it may result in electric shock or fire.
  - When a repair is needed, contact your nearest Samsung service center.
- ☒ • If any foreign substance, such as water has entered the appliance, contact your nearest Samsung service center.
  - Failing to do so may result in electric shock or fire.
- ☒ • Do not touch the power cord with wet hands.
  - This may result in electric shock.
- Do not turn the appliance off while an operation is in progress.
  - This may cause a spark and result in electric shock or fire.
- Keep all packaging materials well out of the reach of children, as packaging materials can be dangerous to children.
  - If a child places a plastic bag over its head, the child can suffocate.

**SAVE THESE INSTRUCTIONS**



- 
- ☒ • Do not let children or any person with reduced physical, sensory, or mental capabilities use this appliance unsupervised.
  - Make sure that the appliance's controls and cooking areas are out of the reach of children.
    - Failing to do so may result in electric shock, burns, or injury.
  - Do not touch the inside of the appliance immediately after cooking. The inside of the appliance will be hot.
    - Failing to do so may result in burns.
  - Do not use or place flammable sprays or objects near the oven.
    - Flammable items or sprays can cause fires or an explosion.
  - Do not insert fingers, foreign substances, or metal objects, such as pins or needles into inlets, outlets, or holes. If foreign substances are inserted into any of these holes, contact your product provider or nearest Samsung service center.
  - Do not tamper with, make any adjustments, or repairs to the door. Under no circumstances should you remove the door or outer shell of the oven.

- 
- ☒ • Do not store or use the oven outdoors.
  - Never use this appliance for purposes other than cooking.
    - Using the appliance for any purpose other than cooking may result in fire.
  - Open the cap or stopper of sealed containers (herb tonic tea bottle, baby bottle, milk bottle, and so on) before heating them. Make a hole in food items that have shells (eggs, chestnuts, etc) with a knife before cooking them.
    - Failing to do so may result in burns or injury.
  - Never heat plastic, paper containers, and do not use them for cooking.
    - Failing to do so may result in fire.
  - Do not heat food wrapped in paper from magazines, newspapers, etc.
    - This may result in fire.
  - Do not open the door when the food in the oven is burning.
    - If you open the door, it causes an inflow of oxygen and may cause the food to ignite.

**SAVE THESE INSTRUCTIONS**

## Important safety instructions

---

- ☐ • Do not apply excessive pressure to the door or the inside of the appliance. Do not strike the door or the inside or the appliance.
  - Hanging on to the door may result in the product falling and cause serious injury.
  - If the door is damaged, do not use the appliance. Contact a Samsung service center.
- Do not hold food in your bare hands during or immediately after cooking.
  - Use cooking gloves. The food may be very hot and you could burn yourself.
  - As the handle and oven surfaces may be hot enough to cause burns after cooking, use cooking gloves to protect your hands from burns.

## USAGE CAUTIONS

---

### CAUTION

- ☑ • If the surface is cracked, turn the appliance off.
  - Failing to do so may result in electric shock.
- Dishes and containers can become hot. Handle with care.
- Hot foods and steam can cause burns. Carefully remove container coverings, directing the steam away from your hands and face.
- Remove lids from baby food jars before heating. After heating baby food, stir well to distribute the heat evenly. Always test the temperature by tasting before feeding the baby. The glass jar or the surface of the food may appear to be cooler than the interior, which can be hot enough to burn an infant's mouth.
- Take care as beverages or food may be very hot after heating.
  - Especially when feeding a child. Check that it has cooled sufficiently.

**SAVE THESE INSTRUCTIONS**

- 
- ★ • Take care when heating liquids, such as water or other beverages.
    - Make sure to stir during or after cooking.
    - Avoid using a slippery container with a narrow neck.
    - Wait at least 30 seconds after heating before removing the heated liquid.
    - Failing to do so may result in an abrupt overflow of the contents and cause burns.
  - ☒ • Do not stand on top of the appliance or place objects (such as laundry, an oven cover, lighted candles, lighted cigarettes, dishes, chemicals, metal objects, etc.) on the appliance.
    - Items, such as a cloth, may get caught in the door.
    - This may result in electric shock, fire, problems with the product, or injury.
  - Do not operate the appliance with wet hands.
    - This may result in electric shock.
  - Do not spray volatile substances, such as insecticide onto the surface of the appliance.
    - As well as being harmful to humans, it may also result in electric shock, fire, or problems with the product.
- 
- ☒ • Do not put your face or body close to the appliance while cooking or when opening the door just after cooking.
    - Take care that children do not come too close to the appliance.
    - Failing to do so may result in children burning themselves.
  - Do not place food or heavy objects over the edge of the oven door.
    - If you open the door, the food or object may fall and this may result in burns or injury.
  - Do not abruptly cool the door, the inside of the appliance, or a dish by pouring water over it during or just after cooking.
    - This may result in damage to the appliance. The steam or water spray may result in burns or injury.
  - Do not operate while empty except for self-cleaning.
  - Do not defrost frozen beverages in narrow-necked bottles. The bottles can break.
  - Do not scratch the glass of the oven door with a sharp object.
    - This may result in the glass being damaged or broken.
  - Do not store anything directly on top of the appliance when it is in operation.

**SAVE THESE INSTRUCTIONS**

## Important safety instructions

---

- ☐ • Do not use sealed containers. Remove seals and lids before cooking. Sealed containers can explode due to the build up of pressure even after the oven has been turned off.
- Take care that food you are cooking in the oven does not come into contact with the heating element.
  - This may result in fire.
- Do not overheat food.
  - Overheating food may result in fire.

## CRITICAL CLEANING WARNINGS

---

### ⚠ CAUTION

- ☑ • Do not clean the appliance by spraying water directly on to it.
- Do not use benzene, thinner, or alcohol to clean the appliance.
  - This may result in discoloration, deformation, damage, electric shock, or fire.
- ☑ • Take care not to hurt yourself when cleaning the appliance (externally or internally).
  - You may hurt yourself on the sharp edges of the appliance.
- Do not clean the appliance with a steam cleaner.
  - This may result in corrosion.
- Keep the inside of the oven clean. Food particles or spattered oils stuck to the oven walls or floor can cause paint damage and reduce the efficiency of the oven.

## SAVE THESE INSTRUCTIONS

# Introducing your new range

## Overview

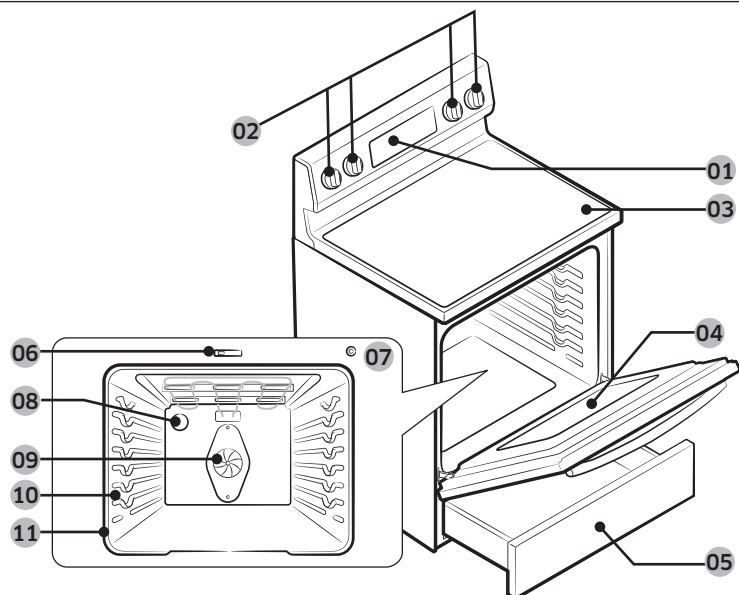

- |  |   |                          |
|--|---|--------------------------|
| <b>01</b> Oven control panel<br>(See page 28 for more information) | <b>02</b> * Surface control knobs<br>(See page 23 for more information) | <b>03</b> Glass surface  |
| <b>04</b> Oven door  | <b>05</b> Storage drawer  | <b>06</b> Door latch     |
| <b>07</b> Automatic oven light switch                              | <b>08</b> * Oven light  | <b>09</b> Convection fan |
| <b>10</b> Shelf position   | <b>11</b> Gasket  |                          |

## What's included



Wire racks (2) \*



Air fry tray (1) \*

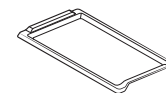

Griddle (1) \*

### NOTE

If you need an accessory marked with a \*, you can buy it from the Samsung Contact Center (1-800-726-7864).

## Before you begin

---

Clean the oven thoroughly before using it for the first time. Then, remove the accessories, set the oven to bake, and then run the oven at 400 °F for 1 hour. There will be a distinctive odor. This is normal.

Ensure your kitchen is well ventilated during this conditioning period.

### Energy saving tips

---

- During cooking, the oven door should remain closed except when you turn food over.  
Do not open the door frequently during cooking to maintain the oven temperature and to save energy.
- If cooking time is more than 30 minutes, you can switch the oven off 5-10 minutes before the end of the cooking time to save energy. The residual heat will complete the cooking process.
- To save energy and reduce the time needed for reheating the oven, plan oven use to avoid turning the oven off between cooking one item and the next.
- Whenever possible, cook more than one item at a time.

## Surface cooking

---

### About surface cooking

---

#### CAUTION

##### BEFORE COOKING

- Do not use the glass cooktop surface as a cutting board.
- Do not place or store items that can melt or catch fire on the glass cooktop, even when it is not being used.
- Turn the surface units on only after placing cookware on them.
- Do not store heavy items above the cooktop surface. They could fall and damage it.

#### CAUTION

##### DURING COOKING

- Do not place aluminum foil or plastic items, such as salt and pepper shakers, spoon holders, or plastic wrappings on the range when it is in use. The hot air from the vent could melt plastics or ignite flammable items.
- Make sure the correct surface unit is turned on.
- Never cook directly on the glass. Always use cookware.
- Always place the pan in the center of the surface unit you are cooking on.
- Never leave surface units unattended while using a high heat setting. Boilovers cause smoking and greasy spillovers that may catch on fire.
- Turn the surface units off before removing cookware.
- Do not use plastic wrap to cover food. Plastic may melt onto the surface and be very difficult to remove.

**⚠ CAUTION**

**AFTER COOKING**

- Do not touch the surface units until they have cooled down.
- The surface may still be hot and burns may occur if you touch the glass surface before it has cooled down sufficiently.
- Immediately clean spills on the cooking area to prevent a tough cleaning chore later.
- If cabinet storage is provided directly above the cooking surface, make sure that the items are infrequently used and can be safely stored in an area subjected to heat. Temperatures may be unsafe for items, such as volatile liquids, cleaners, or aerosol sprays.

**About the radiant surface elements**

The temperature rises gradually and evenly. As the temperature rises, the radiant element will glow red. To maintain the selected setting, the element will cycle on and off. The heating element retains enough heat to provide a uniform and consistent heat during the off cycle. For efficient cooking, turn off the element several minutes before cooking is complete. This will allow residual heat to complete the cooking process.

**📄 NOTE**

Radiant elements have a limiter that allows the element to cycle ON and OFF, even at the HI setting. This helps to prevent damage to the ceramic cooktop. Cycling at the HI setting is normal and can occur if the cookware is too small for the radiant element or if the cookware bottom is not flat.

**Location of the radiant surface elements and controls**

The radiant control knobs operate the radiant surface elements on the cooktop as shown below.

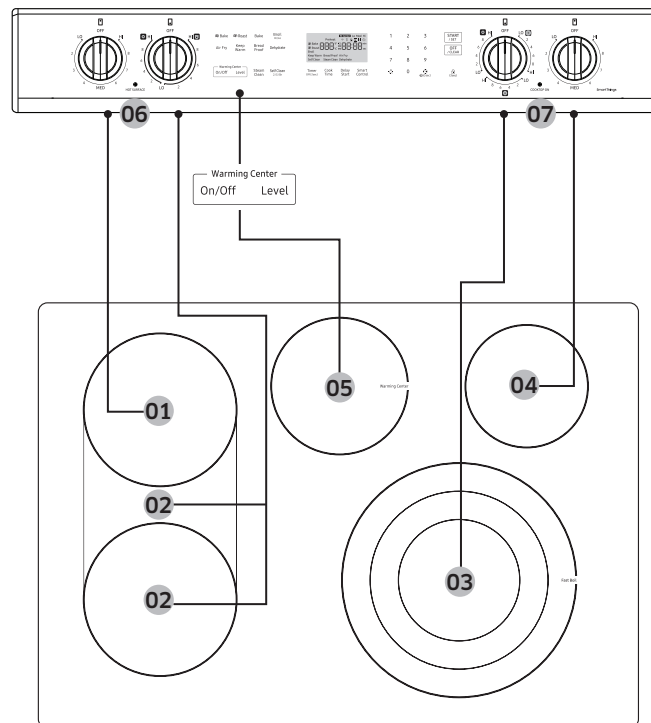

- |                                     |  |   |
|-------------------------------------|--|---|
| <b>01</b> Left Rear:<br>7", 1800 W  | <b>02</b> Left Front:<br>7", 1800 W<br>(Bridge 2600 W) | <b>03</b> Right Front:<br>6"/9"/12", 3000 W |
| <b>04</b> Right Rear:<br>6", 1200 W | <b>05</b> Warming Center:<br>100 W                     | <b>06</b> Hot surface<br>indicator          |
| <b>07</b> Cooktop On/Off<br>lamp    |  |   |

# Surface cooking

## Hot surface indicator

- Comes on when the unit is turned on or hot to the touch.
- Stays on even after the unit is turned off.
- Glows until the unit is cooled to approximately 150 °F.

## Cooktop on/off lamp

- The lamp turns on when the surface control knobs are not in off position.
- The lamp turns off when the surface control knobs are in off position.

## Cooking areas

- The cooking areas on your range are identified by permanent circles on the glass cooking surface. For the most efficient cooking, fit the pan size to the element size.
- **Pans should not extend more than ½" to 1" beyond the cooking area.**
- When a control is turned on, you can see a glow through the glass cooking surface. **The element will cycle on and off to maintain the preset heat setting, even at high settings.**
- For more information on selecting proper types of cookware, refer to the section "Using the proper cookware" on page 26.

## How to set the appliance for surface cooking

### ⚠ CAUTION

- The surface elements may be hot even when off and burns can occur. Do not touch the surface elements until they have cooled down sufficiently.
- At high or medium-high settings, never leave food unattended. Boilovers cause smoking and greasy spillovers may catch on fire.
- Be sure you turn the control knob to **OFF** when you finish cooking.

### Single surface unit control knob (Left Rear, Right Rear)

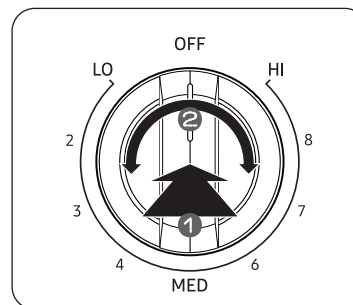

1. Push the knob in.
2. Turn in either direction to the setting you want.
  - At both the off and high settings, the knob clicks into position.

### Bridge surface unit control knob (Left Front)

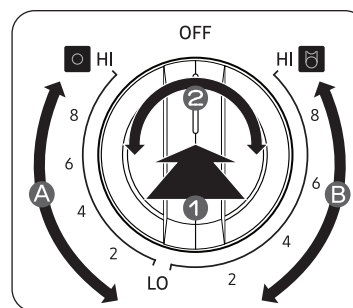

1. Push the knob in.
2. Turn in either direction to the setting you want.
  - To use the single surface unit, turn the control knob to the **single burner (A)** setting.
  - To use the bridge surface unit, turn the control knob to the **bridge burner (B)** setting.



### Triple surface unit control knob (Right Front)

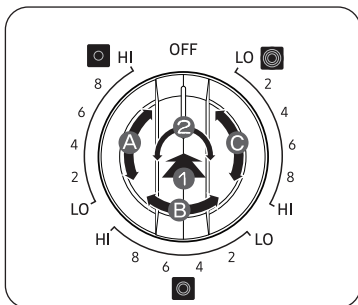

The triple surface unit has 3 cooking sizes to select from so you can match the size of the cooking area to the size of the cookware you are using.

1. Push the knob in.
2. Turn in either direction to the setting you want.
  - To use the small surface unit, turn the control knob to the **small burner (A)** settings.
  - To use the middle surface unit, turn the control knob to the **middle burner (B)** settings.
  - To use the large surface unit, turn the control knob to the **large burner (C)** settings.

#### NOTE

If you remove the knob for cleaning, make sure to reattach it in the correct orientation. (Refer to the illustration above.)

#### CAUTION

- Please note, operation of lighting knob may not synchronize with the actual operation of the radiant heater when there is a problem with the product.
- The area on the knob between the high and off settings is not appropriate for cooking.

### Recommended settings

SETTING	TYPE OF COOKING
HIGH	Starting most foods, bringing water to a boil, pan broiling
MEDIUM HIGH	Continuing a rapid boil, frying, deep fat frying
MEDIUM	Maintaining a slow boil, thickening sauces and gravies, steaming vegetables
MEDIUM LOW	Keeping foods cooking, poaching, stewing
LOW	Keeping foods warm, melting, simmering

### Using the warming center

The **warming center**, located in the back center of the glass surface, will keep hot, cooked food at serving temperature.

#### NOTE

The surface warmer will not glow red like the cooking elements.

#### CAUTION

- Do not warm food on the warming center for more than two hours.
- Use only cookware and dishes recommended as safe for oven and cooktop use.
- Always use potholders or oven mitts when removing food from the warming center as cookware and plates will be hot.
- When warming pastries and breads, use covers that have an opening to allow moisture to escape.
- Do not use plastic wrap to cover foods. Plastic may melt onto the surface and be very difficult to clean off.
- Always start with hot food. Eating uncooked or cold food placed on the warming center could result in illness.

# Surface cooking

1. To turn the warming center on, press the **Warming Center On/Off** pad.
2. Select the power setting you want. Press the **Warming Center Level** pad once for Low, twice for Medium, or three times for High.
3. To turn the warming center off, press the **Warming Center On/Off** pad.

**NOTE**

- Pressing **OFF/CLEAR** does not turn the warming center off.
- For best results, all foods on the warming center should be covered with a lid or aluminum foil. When warming pastries or breads, the lid or foil should be vented to allow moisture to escape.

**Recommended settings**

LEVEL	TYPE OF FOOD
Low	Breads/pastries, casseroles, gravies, eggs
Medium	Dinner plate with foods, soups (cream), vegetables, sauces, stews, meats
High	Fried foods, soups (liquid), hot beverages

## Using the proper cookware

Using the right cookware can prevent many problems, such as uneven cooking or extended cooking times. Using the proper pots and pans will reduce cooking times and cook food more evenly.

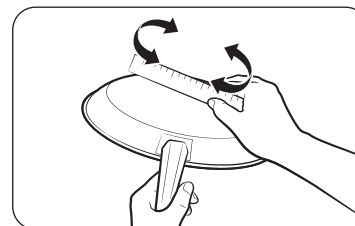

Check for flatness by rotating a ruler across the bottom of the cookware.

**CORRECT**

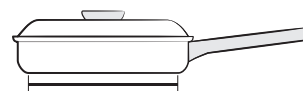

Flat bottom and straight sides.

- Tight fitting lids.
- Weight of handle does not tilt pan.
- Pan is well balanced.
- Pan size matches the amount of food to be prepared and the size of the surface element.
- Made of a material that conducts heat well.

Always match pot diameter to element surface diameter.

**INCORRECT**



Curved and warped pan bottoms.

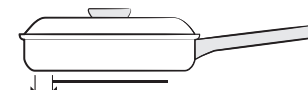

Pan overhangs element by more than one-half inch.

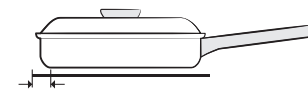

Pan is smaller than element.



Heavy handle tilts pan.

## Choosing the proper cookware

What your cookware is made of determines how evenly and quickly heat is transferred from the surface element to the pan bottom.

- **ALUMINUM** - Excellent heat conductor. Some types of food will cause the aluminum to darken. (Anodized aluminum cookware resists staining & pitting). If aluminum pans are slid across the ceramic cooktop, they may leave metal marks that resemble scratches. Remove these marks as soon as the cooktop cools down.
- **COPPER** - Excellent heat conductor but discolors easily. May leave metal marks on ceramic glass (to remove, see above.)
- **STAINLESS STEEL** - Slow heat conductor with uneven cooking results. It's durable, easy to clean, and resists staining.
- **CAST IRON** - A poor conductor; retains heat very well. Cooks evenly once cooking temperature is reached. Not recommended for use on ceramic cooktops.
- **ENAMELWARE** - Heating characteristics will vary depending on the base material. Porcelain enamel coating must be smooth to avoid scratching ceramic cooktops.
- **GLASS** - Slow heat conductor. Not recommended for ceramic cooktop surfaces because it may scratch the surface.

## Griddle

The coated griddle provides an extra cooking surface. This is useful especially when cooking meats, pancakes, or other foods requiring a large cooking space. The griddle is available only with the bridge element. Use caution when putting the griddle on the bridge element.

It is advisable to preheat the griddle. See the table below.

Type of Food	Preheat Time	Preheat Condition	Cook Condition
Pancakes	5 min.	MED	MED
Hamburgers / Bacon	5 min.	6	6
Fried Eggs / Sausages	5 min.	4	4
Grilled Cheese Sandwiches	5 min.	6	4

\* This table is for reference only.

## CAUTION

- Do not remove the griddle until the cooktop, surfaces, and griddle itself cool down.
- The griddle on the cooktop may become very hot when you use the cooktop or oven. Use oven gloves when placing or removing the griddle.
- The griddle is quite heavy. Use both hands when placing or removing the griddle.
- Put the griddle in the glass heater print position properly and use it.
- Do not impact cooktop glass with griddle.
- Do not drag griddle on cooktop glass.
- Do not overheat the griddle. This can damage the coating of the griddle.
- Do not use metal utensils that can damage the griddle surface.
- Do not use the griddle for other purposes like a cutting board or storage.
- Do not cook excessively greasy foods. The grease may spill over.
- Do not preheat cooking for more than 10 minutes. They can be transformed.
- Be careful when cooking, griddle may move.

## NOTE

- Griddle settings may need to be readjusted over time.
- The griddle may discolor over time as it becomes seasoned with use.
- Do not leave the griddle rusty. Remove the rust before or during use of the griddle.

## Surface cooking

### Protecting the cooktop

#### Cleaning

- Clean the cooktop before using it for the first time.
- Clean your cooktop daily or after each use. This will keep your cooktop looking good and can prevent damage.
- If a spillover occurs while you are cooking, immediately clean the spill from the cooking area while it is hot to prevent a tough cleaning chore later. Using extreme care, wipe the spill with a clean, dry towel.
- Do not allow spills to remain on the cooking area or the cooktop trim for a long period of time.
- **Do not** use abrasive cleansing powders or scouring pads, which will scratch the cooktop.
- **Do not** use chlorine bleach, ammonia, or other cleansers not specifically recommended for use on a glass-ceramic surface.

#### Preventing marks and scratches

- Do not use glass cookware. It may scratch the cooktop.
- **Do not** place a trivet or wok ring between the cooktop and the pan. These items can mark or scratch the cooktop.
- Make sure the cooktop and the pan bottom are clean.
- **Do not** slide metal pans across the cooktop.

#### Preventing stains

- **Do not** use a soiled dish cloth or sponge to clean the cooktop surface. A film will remain, which may cause stains on the cooking surface after the area is heated.
- Continuously cooking on a soiled surface can result in a permanent stain.

#### Preventing other damage

- Do not allow plastic, sugar, or foods with high sugar content to melt onto the hot cooktop. Should this happen, clean immediately.
- Do not let a pan boil dry as this will damage the cooktop and the pan.
- **Do not** use the cooktop as a work surface or cutting board.
- **Do not** cook food directly on the cooktop. Always use the proper cookware.

## Operating the oven

### The oven control panel

**READ THE INSTRUCTIONS CAREFULLY BEFORE USING THE OVEN.** For satisfactory use of your oven, become familiar with the various features and functions of the oven as described below. **Detailed instructions for each feature and function follow later in this user manual.**

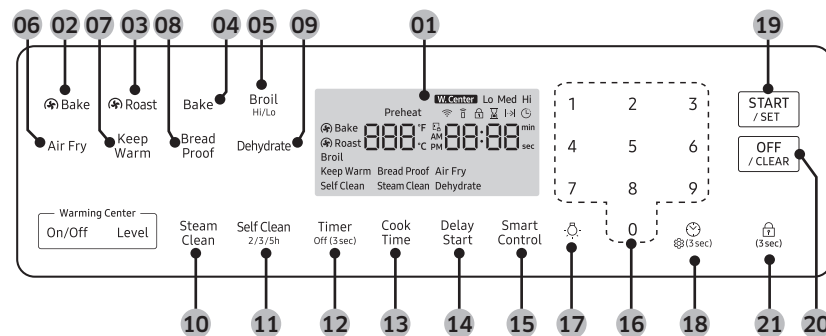

- 01 Display:** Shows the time of day, oven temperature, what mode the oven is operating in, and the time set for the timer or automatic oven operations.
- 02 Convection Bake:** Use to select the Convection bake function of the oven.
- 03 Convection Roast:** Use to select the Convection roast function of the oven.
- 04 Bake:** Use to select the bake function of the oven.
- 05 Broil:** Use to select the broil function of the oven.
- 06 Air Fry:** Use to select the air fry function of the oven.
- 07 Keep Warm:** Use to select the keep warm function of the single oven to keep cooked foods warm.
- 08 Bread Proof:** Use to select the bread proof function of the oven.
- 09 Dehydrate:** Use to select the dehydrate function of the oven.
- 10 Steam Clean:** Use to select the steam cleaning function of the oven.
- 11 Self Clean:** Use to select the self-cleaning function of the oven.
- 12 Timer:** Use to set or cancel the kitchen timer. The kitchen timer does not start or stop cooking. Press and hold for 3 seconds to turn off the timer.

- 13 Cook Time:** Press and then use the number pad to set the amount of time you want your food to cook. The oven will shut off when the cooking time has run out.
- 14 Delay Start:** Press to set the oven to start and stop automatically at a time you set.
- 15 Smart Control:** Use to select the smart control feature.
- 16 Number pad:** Use to set any function requiring numbers, such as the time of day on the clock, the timer, the oven temperature, the start time and length of operation for timed baking, etc.
- 17 Lamp:** Press to turn the oven light on or off.
- 18 Clock / Setting :** Use to set the time of day. Use to bring up the user preference menu in the display. (Press for 3 seconds.)
- 19 START / SET:** Use to start any cooking or cleaning function in the oven.
- 20 OFF / CLEAR:** Press to cancel all oven operations except the clock and timer. Press to cancel a previously entered temperature or time.
- 21 Oven lock:** Use to disable all oven functions.

## Oven lock

Lock the oven door and the buttons on the touch pad so they cannot be activated accidentally.

Oven lock can only be activated in standby mode.

### How to activate the oven lock feature

Press **Oven lock**  for 3 seconds.

The display will show the Lock  icon as well as the current time.

All functions must be cancelled before Oven lock is activated.

This function is available only when the oven temperature is under 400 °F.

### How to unlock the Oven

Press **Oven lock**  for 3 seconds.



The Lock  icon will disappear from the display.

## Setting the clock

The **clock** must be set to the correct time of day for the automatic oven timing functions to work properly.

- The time of day cannot be changed during timed cooking, delay-timed cooking, or a self-cleaning cycle.
- You can choose between a 12-hour or 24-hour display. The default is 12-hour.

### How to set the clock

1. Press **Clock** .
2. Press **Clock**  to select AM or PM. (Skip this step on 24 hour display setting.)
3. Enter the current time in hours and minutes on the number pad, e.g., 1, 3, 0, for 1:30.
4. Press **Clock**  or **START/SET** to save the changes.

## Setting the kitchen timer

The kitchen timer serves as an extra timer that will beep when the set time has elapsed. It does not start or stop cooking functions. You can use the kitchen timer with any of the other oven functions.

### How to set the timer

1. Press **Timer**.
2. Enter a desired time using the number pad.
3. When done, press **START/SET**.
4. To cancel the **Timer** settings, press and hold Timer for 3 seconds.
5. When the set time elapses, the oven beeps and displays the “End” message. Press **Timer** to delete the message.

### NOTE

To change the programmed timer, press **Timer**, enter a different time, and then press **START/SET**.

# Operating the oven

## Timed cooking

In timed cooking, the oven turns on immediately and cooks for the length of time you select. At the end of the cooking time, the oven turns off automatically.

- You can use the timed cooking feature only with another cooking operation (bake, convection bake, convection roast, air fry, dehydrate).

### How to set the oven for timed cooking

- Start the cooking operation you want, e.g., **Bake**.  
The default temperature is 350 °F.
- Press **Cook Time**.
  - You can set the Cook Time at any time. (After selecting the cook mode, during preheating, after preheating.)
- Enter the cooking time you want, e.g., 45 min, using the number pad.  
You can set the cooking time for any amount of time from 1 minute to 9 hours and 59 minutes.
- Press **START/SET**. The temperature display will start to change once the oven temperature reaches 175 °F.  
The oven will continue to cook until the set amount of time has elapsed, then turn off automatically unless you set the keep warm feature. (Refer to the section on the keep warm feature on page 38.)
- You can cancel a cook time at any time by setting the cook time to 0 minutes. (Press **Cook Time** -> set cook time to 0 min -> press **START/SET**)

### NOTE

When timed cooking is done, the range will beep several times.

### CAUTION

Use caution with the **timed cooking** or **delay start** features. Use these features to cook cured or frozen meats and most fruits and vegetables. Foods that can easily spoil, such as milk, eggs, fish, meat, or poultry, should be chilled in the refrigerator first. Even when chilled, they should not stand in the oven for more than 1 hour before cooking begins, and should be removed promptly when cooking is completed. Eating spoiled food can result in sickness from food poisoning.

## Delay start

In a delay timed cooking, the oven's timer turns the oven on and off at times you select in advance.

- You can use the delay start feature only with another cooking operation (bake, convection bake, convection roast, air fry, dehydrate, or self-clean).
- You can set the oven for a delay start before setting other cooking operations.
- The clock must be set to the current time.

### How to set the oven for delay start











- Position the oven rack(s) and place the food in the oven.
- Press the pad for the cooking operation you want, e.g., **Bake**.  
The default temperature is 350 °F.
- Enter the temperature you want, e.g., 375 °F, using the number pad.
- Set the cooking time if you want. (Refer to the section on the timed cooking feature on page 30.)
- Press **Delay Start**.
- Enter the time you want the oven to turn on, e.g., 4:30, using the number pad.
- Press **START/SET**. At the set time, a short beep will sound. The oven will begin to bake.

## Turning the oven light on and off

- The oven light turns on automatically when the door is opened.
- The oven light turns off automatically when the door is closed.
- You can turn the oven light on and off manually by pressing the  pad.

## Minimum and maximum settings

All of the features listed in the table below have minimum and maximum time or temperature settings. A beep will sound each time a pad on the control panel is pressed and the entry is accepted. An error tone will sound in the form of a long beep if the entered temperature or time is below the minimum or above the maximum setting for the feature.

FEATURE	MINIMUM	MAXIMUM
 Bake	175 °F (80 °C)	550 °F (285 °C)
 Broil	LO	HI
 Convection Bake	175 °F (80 °C)	550 °F (285 °C)
 Convection Roast	175 °F (80 °C)	550 °F (285 °C)
 Air Fry	350 °F (175 °C)	500 °F (260 °C)
 Dehydrate	100 °F (40 °C)	225 °F (105 °C)
 Keep Warm*	-	3 Hr.
 Bread Proof	-	12 Hrs.
 Self Clean	2 Hr.	5 Hr.
 Steam Clean	20 Min.	20 Min.

### NOTE

If you turn off the 12-hour energy saving feature, the feature marked with a \* will operate until canceled. (12-hour energy saving's default setting : on) See page 41 for more information.

## Using the oven racks

### Oven rack positions

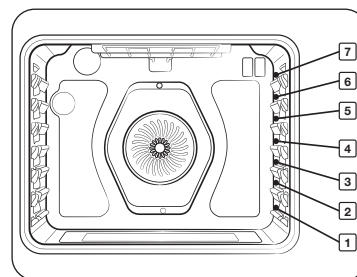

Recommended rack position for cooking

TYPE OF FOOD	RACK POSITION
Broiling hamburgers	7
Broiling meats or small cuts of poultry, fish	4-6
Bundt cakes, pound cakes, frozen pies, casseroles	3 or 4
Angel food cakes, small roasts, fresh and frozen pizza	2
Turkey, large roast, hams, fresh pizza	1

- This table is for reference only.

# Operating the oven

## Rack and Pan placement

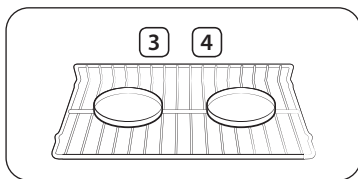

Single Oven Rack

Centering the baking pans in the oven as much as possible will produce better results. If baking with more than one pan, place the pans so each has at least 1" to 1½" of air space around it.

When baking on a single oven rack, place the oven rack in **position 3 or 4**. See the figure on the left.

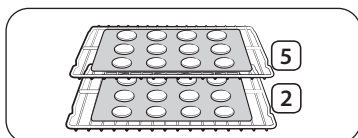

Cakes place the oven racks in **positions 3 and 5**. Cookies place the racks in **positions 2 and 5**.

### Using Multiple Oven Racks

Type of Baking	Rack Positions
Cookies	2 and 5
Cakes	3 and 5

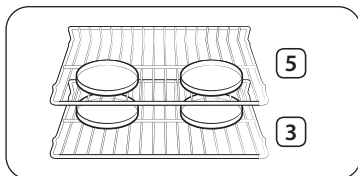

Multiple Oven Rack

## Before using the racks

The oven has two racks.

Each rack has stops that need to be placed correctly on the supports. These stops will keep the rack from coming completely out.

### REMOVING THE RACKS

1. Pull the rack straight out until it stops.
2. Lift up the front of the rack, and then pull it out.

### REPLACING THE RACKS

1. Place the end of the rack on the support.
2. Tilt the front end up and push the rack in.

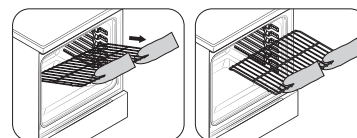
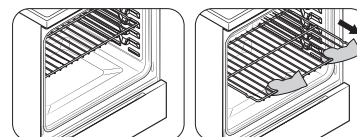

### ⚠ CAUTION

- Do not cover a rack with aluminum foil or place aluminum foil on the oven bottom. This will hamper heat circulation, resulting in poor baking, and may damage the oven bottom.
- Arrange the oven racks only when the oven is cool.



## Baking

The oven can be programmed to bake at any temperature from 175 °F to 550 °F. Baking temperature and time will vary depending on the ingredients and the size and shape of the baking pan used. Dark or nonstick coatings may cook faster with more browning.

### How to set the temperature

1. Press **Bake**. The default temperature is 350 °F.
2. Enter the temperature you want on the number pad, e.g., 3, 7, 5.
3. Press **START/SET**. The temperature display will start to change once the oven temperature reaches 175 °F.
4. If you want to cancel baking or if you have finished, press **OFF/CLEAR**.

- ★ Place food in the oven after preheating if the recipe calls for it. Preheating is very important for good results when baking cakes, cookies, pastry, and breads. After the oven has reached the desired temperature, the range will beep several times.

### NOTE

For performance reasons, the convection fan may be turned on or off during the operation.

### How to adjust the temperature while cooking

1. Press **Bake**. The display will show the present temperature, e.g., 375 °F.
2. Enter the temperature you want, e.g., 425 °F, using the number pad.
3. Complete the entry by pressing **START/SET**.

## Convection baking

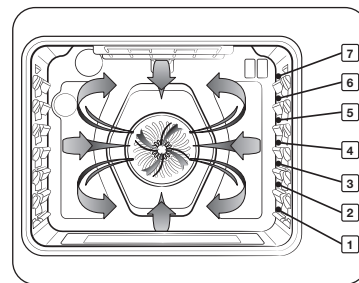

By using the convection bake feature, you will be able to cook faster. Convection baking uses a fan to circulate the oven's heat evenly and continuously within the oven. This improved heat distribution allows for even cooking and excellent results while using multiple racks at the same time. Foods cooked on a single oven rack will generally cook faster and more evenly with convection baking. Multiple oven rack cooking may slightly increase cook times for some foods, but the overall result is time saved. Breads and pastries brown more evenly. You can program the oven for convection baking at any temperature between 175 °F and 550 °F.

### Tips for convection baking

The amount of time you save will vary depending on the amount and type of food you are cooking. When baking cookies or biscuits, you should use pans with no sides or very low sides to allow the heated air to circulate around the food. Using a pan with a dark finish will produce faster cooking times.

When using convection baking with a single rack, place the oven rack in **position 3 or 4**. If cooking on multiple racks, place the oven racks in **position 3 and 5 or 2 and 5**.

When baking a cake, using the bake mode (not the convection bake mode) will produce better results.

# Operating the oven

## How to set the oven for convection baking

1. Press  **Bake**. The default temperature is 325 °F.
2. Enter the temperature you want, e.g., 400 °F, using the number pad.
3. Press **START/SET**.  
The temperature display will start to change once the oven temperature reaches 175 °F.  
The range will beep several times when the oven reaches the adjusted oven temperature.
4. To turn off or cancel convection baking, press **OFF/CLEAR**.

-  • The convection oven fan shuts off when the oven door is opened.
- DO NOT leave the door open for long periods of time while using convection cooking or you may shorten the life of the convection heating element.

### NOTE

If you leave the oven door open for more than 2 minutes when the oven is on, all heating elements will shut off automatically.

### NOTE

For performance reasons, the convection fan may be turned on or off during the operation.

## Convection roasting

Convection roasting is good for cooking large tender cuts of meat, uncovered. Heat comes from the top heating element. The convection fan circulates the heated air evenly over and around the food. Meat and poultry are browned on all sides as if they were cooked on a rotisserie. The heated air seals in juices quickly for moist and tender results while, at the same time, creating a rich golden brown exterior.

### How to set the oven for convection roasting

1. Press  **Roast**. The default temperature is 325 °F.
2. Enter the temperature you want, e.g., 400 °F, using the number pad.
3. Press **START/SET**.  
The temperature display will start to change once the oven temperature reaches 175 °F. The range will beep several times when the oven reaches the adjusted oven temperature.
4. To turn off or cancel convection roasting, Press **OFF/CLEAR**.

-  • The convection oven fan shuts off when the oven door is opened.
- DO NOT leave the door open for long periods of time while using convection cooking or you may shorten the life of the convection heating element.

### NOTE

If you leave the oven door open for more than 2 minutes when the oven is on, all heating elements will shut off automatically.

### NOTE

For performance reasons, the convection fan may be turned on or off during the operation.

## Broiling

Broiling is a method of cooking tender cuts of meat by direct heat under the broil element of the oven.

The high heat cooks quickly and gives a rich, brown outer appearance. Broil mode is best for meats, fish, and poultry up to 1" thick.

Always preheat the oven for 4 minutes before broiling.

### How to set the oven for broiling

1. Press **Broil** once for Hi or twice for Lo.  
Use Lo to cook foods such as poultry or thick cuts of meat thoroughly without over-browning them.
2. To start broiling, press **START/SET**.  
Broil one side until the food is browned. Turn over and broil the other side.
3. Press **OFF/CLEAR** once you have finished cooking or if you want to cancel broiling.

### Broil stop position

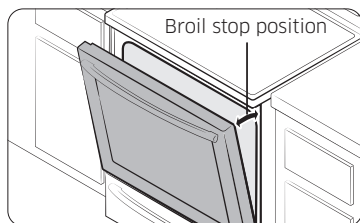

Leave the door open at the broil stop position. The door will stay open by itself, yet the proper temperature is maintained in the oven.

#### **⚠ CAUTION**

Should an oven fire occur, close the oven door and turn the oven off. If the fire continues, throw baking soda on the fire or use a foam-type fire extinguisher. Do not put water or flour on the fire. Flour can explode and water can cause a grease fire to spread and cause personal injury.

## Broiling Recommendation Guide

The size, weight, thickness, starting temperature, and your doneness preference will affect broiling times. This guide is based on meats at refrigerator temperature. Always use a broiler pan and its grid when broiling. Always preheat the oven for 4 minutes before broiling.

Food	Doneness	Size	Thickness	Broil Setting	Rack position	Cooking time	
						1st side	2nd side
Hamburgers	Medium	9 patties	1"	HI	7	3:20-3:40	2:20-2:40
Beef steak	Medium	-	1"	HI	5	7:00-8:00	6:00-7:00
	Medium	-	¾"	HI	5	6:00-7:00	5:00-6:00
Chicken pieces	Well done	2-2½ lbs.	¾"-1"	HI	4	15:00-16:00	13:00-14:00
Pork chops	Well done	1 lb.	½"	LO	5	15:00-16:00	13:00-14:00
Lamb chops	Well done	1 lb.	¾"-1"	HI	5	5:00-6:00	4:00-5:00
Salmon steak	Well done	3 pcs.	¾"-1"	HI	5	4:00-7:00	3:00-6:00

# Operating the oven

## Air fry

This feature works special hot air for crispier and healthier frozen or fresh foods without or less oil than normal convection modes. For best results, use this mode on a single oven rack and place the Air fry tray on the position 3. The temperature can be set between 350 °F and 500 °F. Preheating is not necessary for this mode. Follow recipe or package directions for set temperature, time or quantity.

### How to set the oven for Air Fry mode

1. Place the tray on rack position 3.
2. Select **Air Fry** mode.
3. Use the number pad to change the default temperature. Enter the suggested temperature for your food as recommended cooking guide. The default temperature is 425 °F.
4. Set the Cook Time or Delay Start, if necessary.
5. Tap **START/SET**.
6. When cooking is complete, tap **OFF/CLEAR** and take out the food.

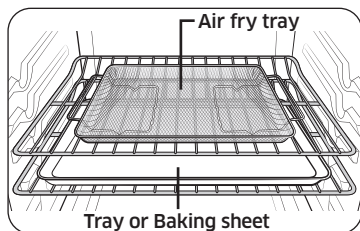

**Air Fry Tray recommended placement**

### NOTE

- Place a baking sheet or tray on the rack below the Air fry tray for getting any drippings. This will help to reduce splatter and smoke.
- Before using a baking sheet, check the maximum allowable temperature of baking sheet.
- Air fry is designed for a single oven rack. Place food on rack position 3 for best results.
- For cooking fresh or homemade foods, spread the oil over a larger area more evenly, crisping up the food more effectively.

## Air fry cooking guide

Item	Amount	Temperature	Time
<b>Potatoes</b>			
Frozen French Fries	30-35 oz	425 °F-450 °F	25-30 min
Frozen French Fries, Seasoned	25-30 oz	425 °F-450 °F	20-25 min
Frozen Tater Tots	40-45 oz	450 °F	20-25 min
Frozen Hash Brown	25-30 oz	425 °F-450 °F	20-25 min
Frozen Potato Wedges	30-35 oz	425 °F-450 °F	20-25 min
Homemade French Fries	25-30 oz	400 °F-425 °F	25-30 min
Homemade Potato Wedges	40-45 oz	425 °F-450 °F	25-30 min
<b>Frozen</b>			
Frozen Chicken Nuggets	24-28 oz	400 °F-425 °F	15-25 min
Frozen Chicken Wings	30-35 oz	425 °F-450 °F	20-30 min
Frozen Onion Rings	20-25 oz	400 °F-425 °F	15-20 min
Frozen Fish Fingers	20-25 oz	425 °F	18-22 min
Frozen Chicken Strips	25-30 oz	425 °F-450 °F	20-30 min
Frozen Churros	20-25 oz	425 °F	18-22 min

Item	Amount	Temperature	Time
<b>Poultry</b>			
Fresh Drumsticks	40-45 oz	425 °F-450 °F	30-35 min
Fresh Chicken Wings	30-35 oz	425 °F-450 °F	27-32 min
Chicken Breasts, Breaded	25-30 oz	450 °F	25-30 min
<b>Vegetables</b>			
Asparagus, Breaded	15-20 oz	425 °F	20-25 min
Egg Plants, Breaded	20-25 oz	425 °F	20-25 min
Mushroom, Breaded	18-22 oz	425 °F	20-25 min
Onions, Breaded	18-22 oz	425 °F	20-25 min
Cauliflowers, Breaded	40-45 oz	400 °F-425 °F	20-25 min
Vegetable Mix, Breaded	30-35 oz	425 °F	20-25 min

## Using the special function

### Dehydrate

Dehydrate dries food or removes moisture from food via heat circulation. After drying the food, keep it in a cool and dry place. For fruit, adding lemon, pineapple juice, or sprinkling sugar on the fruit helps the fruit retain sweetness.

See the table below for Dehydrate settings.

1. Press **Dehydrate**.
2. Press **START/SET**.
3. Press **OFF/CLEAR** at any time to turn off the Dehydrate feature.

#### NOTE

Use rack position 3 or 4 for dehydrating.

### Bread Proof

The Bread Proof function automatically provides the optimum temperature for the bread proof process and, therefore does not have a temperature adjustment. If you press Bread Proof when the oven temperature is above 95 °F, Hot will appear in the display. Because these functions produce the best results when started while the oven is cool, we recommend that you wait until the oven has cooled down and Hot disappears from the display.

1. Press **Bread Proof**.
2. Press **START/SET**.
3. Press **OFF/CLEAR** at any time to turn off the Bread Proof feature.

#### NOTE

Use rack position 3 for bread proofing.

#### CAUTION

- Do not use Bread proof for warming food. The proofing temperature is not hot enough to keep food warm.
- Place the dough in a heat-safe container on rack position 3 and cover it with a cloth or with plastic wrap. The plastic wrap may need to be anchored underneath the container so that the oven does not blow the plastic wrap off the dough.
- To avoid lowering the temperature and extending proofing time, do not open the oven door.

# Operating the oven

## Using the keep warm feature

When cooking is finished, Keep Warm will hold the food at a safe serving temperature for up to 3 hours.

After 3 hours, the feature will shut off automatically. You can use the keep warm feature without any other cooking operations, or you can set it to activate after a timed or delay timed cooking operation.

You should not use this feature to reheat cold food.

### How to use the keep warm feature

1. Press **Keep Warm**.
2. Press **START/SET**.
3. Press **OFF/CLEAR** at any time to turn the feature off.

### How to set the oven to activate the keep warm mode after a timed cooking

1. Set **Timed Cooking** to start cooking.  
(Refer to the section on the timed cooking feature on page 30.)
2. Press **Keep Warm** to use the feature.
3. Cooking mode is switched directly to Keep Warm mode after the Timed cooking period has ended. In this case, you can turn off Keep Warm by pressing **OFF/CLEAR**.
  - Press **Keep Warm** once again to cancel Keep Warm setting during cooking mode operation.

#### NOTE

If you turn off the **12-hour energy saving** feature, the keep warm feature will operate until canceled. (12-hour energy saving's default setting : on). See page 41 for more information.

## Using the smart control feature

Functions that can be operated from the SmartThings app may not work smoothly if communication condition becomes poor, or the product is installed in a place with a weak Wi-Fi signal.

Please refer to the following table for the main functions that can be operated from the app.

When the remote control is off	Monitoring (Oven, Cooktop), Oven off
When the remote control is on	Monitoring (Oven, Cooktop), Oven start, Oven off, Error check

### How to connect the oven

1. Download and open the SmartThings app on your smart device.
2. Follow the app's on-screen instructions to connect your range.
3. Once the process is complete, the connected  icon located on your range displays and the app will confirm you are connected.
4. If the connection icon does not turn on, follow the instruction in the app to reconnect.

### To start the oven remotely

1. Press **Smart Control** appears in the display. The oven can now be started remotely with a connected device.

### Oven remote control

- Transfer the oven setting (mode, time, temperature) from the device to the oven.
- Remotely start the oven (Only available for Electric range).
- Turn the oven off remotely.
- Once cooking starts, you can change the time, temperature remotely.
- Self clean mode cannot be started remotely.

#### NOTE

- Opening the oven door or pressing **Smart Control** will disable Smart Control and prevent you from turning the oven on remotely.
- If it is not shown on the display, you can still monitor the oven and cooktop status and turn the oven off.
- When oven cooking is finished or cancelled, Smart Control will turn off.

## Using the voice control

To use the Range's Voice Control function, you need Bixby / Amazon Alexa App / Google Assistant App on your mobile device.

Refer to the table below for all available functions.

### Bixby

Start conversation with Bixby on SAMSUNG mobile by saying "Hi Bixby" or by pressing the side key.

Function	"Hi Bixby"
Start/Preheat	<ul style="list-style-type: none"> <li>Preheat the range(oven).</li> <li>Start the range(oven) in convection bake mode[Mode] at 325 degrees[Temp] for 1 hour[Time].</li> <li>Convection bake[Mode] in the range[Device Name] at 325 degrees[Temp].</li> </ul>
Turn Off/Stop	<ul style="list-style-type: none"> <li>Cancel the range(oven).</li> <li>Turn off the range(oven).</li> <li>Stop baking in the range(oven).</li> </ul>
Check Temp	<ul style="list-style-type: none"> <li>What is the temperature of the range(oven)?</li> <li>Check the range(oven) temperature.</li> </ul>
Check Time	<ul style="list-style-type: none"> <li>Check the remaining time of the range(oven).</li> <li>How much range(oven) time is left on the timer?</li> <li>How much time is left on the range timer?</li> </ul>
Check Mode (States)	<ul style="list-style-type: none"> <li>Check the range status.</li> <li>Check the status of the range(oven).</li> </ul>
Temp Control	<ul style="list-style-type: none"> <li>Set the temperature of the range(oven) to 300.</li> <li>Increase the temp of the range(oven) by 20.</li> <li>Decrease the temp of the range(oven) by 20.</li> <li>Turn the range(oven) temperature up to 100 degrees.</li> <li>Turn the range(oven) temperature down to 50 degrees.</li> </ul>
Oven Light	<ul style="list-style-type: none"> <li>Turn on the oven light (lamp).</li> <li>Turn on the range oven light.</li> <li>Turn off the oven light (lamp).</li> <li>Turn off the range oven light.</li> </ul>
Oven Timer (Cook Time)	<ul style="list-style-type: none"> <li>Set the timer on the range(oven) to 1 hour.</li> </ul>

## Amazon Alexa & Google Assistant

Samsung smart home appliances are supported by SmartThings skill in Alexa & action in Google Assistant.

### Installation Guide

Here's how to link SmartThings account into Amazon Alexa or Google Assistant. SmartThings App and Alexa App(or Google Assistant App) should be installed on your phone.

1. Setup the supported devices to SmartThings.
2. After device setup, tap + button on the screen.
3. Tap 'Voice assistant' and link your Samsung account to Amazon Alexa. (or Google Assistant)
4. Check the devices are visible on Amazon Alexa app. Then account linking is complete. (Check the devices are visible and set the location(home&room) of devices in Google home app. Then account linking is complete.)

Function	"Alexa"	"Ok Google"
Start/Preheat	<ul style="list-style-type: none"> <li>Preheat the oven[Device name].</li> <li>Start the oven[Device name].</li> <li>Turn on the oven[Device name].</li> <li>Set the oven[Device name] to bake [Mode].</li> <li>Set the oven[Device name] to bake [Mode] for 1hour [Time] at 350 degrees[Temp].</li> <li>Set the oven[Device name] to bake [Mode] at 350 degrees[Temp].</li> <li>Set the oven[Device name] to bake [Mode] for 1hour [time].</li> </ul>	<ul style="list-style-type: none"> <li>Preheat the oven[Device name].</li> <li>Start the oven[Device name].</li> <li>Turn on the oven[Device name].</li> <li>Set the oven[Device name] to bake [Mode].</li> </ul>
Turn Off/Stop	<ul style="list-style-type: none"> <li>Turn off the oven[Device name].</li> <li>Stop the oven[Device name].</li> </ul>	<ul style="list-style-type: none"> <li>Turn off the oven[Device name].</li> <li>Stop the oven[Device name].</li> </ul>

# Operating the oven

Function	“Alexa”	“Ok Google”
Check Temp	<ul style="list-style-type: none"> <li>What is the temperature of the oven[Device name]?</li> </ul>	<ul style="list-style-type: none"> <li>What is the temperature of the oven[Device name]?</li> </ul>
Check Time	-	<ul style="list-style-type: none"> <li>What time is left on the oven[Device name]?</li> </ul>
Check Mode (States)	<ul style="list-style-type: none"> <li>Is the oven[Device name] running?</li> <li>Is the oven[Device name] on?</li> </ul>	<ul style="list-style-type: none"> <li>Is the oven[Device name] running?</li> <li>What mode is the oven[Device name] set to?</li> </ul>
Temp Control	<ul style="list-style-type: none"> <li>Set oven[Device name] to 300 degrees [Temp].</li> </ul>	<ul style="list-style-type: none"> <li>Set oven[Device name] to 300 degrees [Temp].</li> </ul>
Oven Timer (Cook Time)	<ul style="list-style-type: none"> <li>Set oven[Device name] to 3 hours[Time].</li> <li>Add 10 minutes/hours[Time] to the oven[Device name].</li> </ul>	<ul style="list-style-type: none"> <li>Set oven[Device name] to 3 hours[Time].</li> <li>Add 10 minutes/hours[Time] to the oven[Device name].</li> </ul>

## NOTE

On/Off spec of smart control is same as guided in SmartThings app.

## Using the options function

This function enables you to control various electronic control options. Refer to the following table for available options.

The option menu is only available when the oven is not being used (not cooking).

Options	Feature
<b>1. Temp Adjust</b>	Lets you correct the temperature in the oven.
<b>2. Temp Unit</b>	Lets you program the oven control to display temperatures in Fahrenheit or Celsius.
<b>3. Auto Conversion</b>	The convection auto conversion feature automatically converts entered regular baking temperatures to convection baking temperatures.
<b>4. Time of Day (12hr/24hr)</b>	Lets you set the clock to display the time of day in the 12-hour or 24-hour mode.
<b>5. 12-hour energy saving</b>	This feature automatically turns off the oven after 12-hours during baking functions or after 3 hours during a broil function.
<b>6. Sound On/Off</b>	Lets you set the oven controls to operate silently.
<b>7. Wi-Fi On/Off</b>	Lets you set the wi-fi network to deactivate.
<b>0. Demo mode</b>	This option is for use by retail establishments for display purposes only.

## NOTE

Options key location.

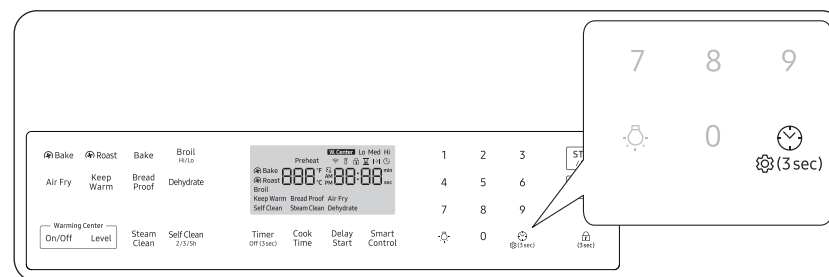





## Temp Adjust

The temperature in the oven has been calibrated at the factory. When first using the oven, be sure to follow recipe times and temperatures. If you think the oven is too hot or too cool, you can correct the temperature in the oven. Before correcting, test a recipe by using a temperature setting that is higher or lower than the recommended temperature. The baking results should help you to decide how much of an adjustment is needed.

The oven temperature can be adjusted  $\pm 35$  °F ( $\pm 19$  °C).

### How to correct the oven temperature

1. Press  (3sec) **Options** for 3 seconds, and then Press **1** on the number pad.
2. Press **Clock**  to select higher or lower than the current temperature.
3. Enter the adjustment you want to make using the number pad. (0-35).
4. Press **START/SET** to save the changes.

### NOTE

This adjustment will not affect the broiling or the self-cleaning temperatures. The adjustment will be retained in memory after a power failure.

## Temp Unit (Fahrenheit or Celsius temperature selection)

You can program the oven control to display the temperature in Fahrenheit or Celsius. The oven has been preset at the factory to display in Fahrenheit.

### How to change the display from Fahrenheit to Celsius or Celsius to Fahrenheit

1. Press  (3sec) **Options** for 3 seconds, and then Press **2** on the number pad.
2. Press **1** (Fahrenheit) or **2** (Celsius) on the number pad.
3. Press **START/SET** to save the changes.

## Auto Conversion

When you use the auto conversion feature, the convection auto conversion feature will automatically convert entered regular baking temperatures to convection baking temperatures.

If this feature is activated, the display will show the actual converted (reduced) temperature. For example, if you enter a regular recipe temperature of 350 °F and press Oven Start/Set, the display will show the converted temperature of 325 °F. (Default setting : off)

### How to enable or disable the auto conversion feature

1. Press  (3sec) **Options** for 3 seconds, and then Press **3** on the number pad.
2. Press **1** (On) or **2** (Off) on the number pad.
3. Press **START/SET** to save the changes.

## Time of Day (12hr/24hr)

The oven control can be programmed to display time of day in the 12-hour or 24-hour mode. -

The oven has been preset at the factory to display in the 12-hour mode.

### How to change between the 12- and 24-hour time of day display

1. Press  (3sec) **Options** for 3 seconds, and then Press **4** on the number pad.
2. Press **1** (12) or **2** (24) on the number pad.
3. Press **START/SET** to save the changes.

## 12-hour energy saving

If you accidentally leave the oven on, this feature will automatically turn off the oven after 12-hours during baking functions or after 3 hours during a broil function. (Default setting : on)

### How to turn the 12-hour energy saving feature on or off

1. Press  (3sec) **Options** for 3 seconds, and then Press **5** on the number pad.
2. Press **1** (On) or **2** (Off) on the number pad.
3. Press **START/SET** to save the changes.

# Operating the oven

## Sound On/Off

Using Sound On/OFF, you can set the oven controls to operate silently.

### How to turn the sound on or off

1. Press  (3sec) **Options** for 3 seconds, and then Press **6** on the number pad.
2. Press **1** (On) or **2** (Off) on the number pad.
3. Press **START/SET** to save the changes.

## Wi-Fi On/Off

You can turn the range's Wi-Fi connection on or off.

### How to turn the Wi-Fi on or off

1. Press  (3sec) **Options** for 3 seconds, and then Press **7** on the number pad.
2. Press **1** (On) or **2** (Off) on the number pad.
3. Press **START/SET** to save the changes.

### NOTE

When you turn the range's Wi-Fi connection off, users can't set to easy setup.

## Demo mode

This option is for use by retail establishments for display purposes only.

(The heating element does not operate.)

### How to enable or disable the demo mode

1. Press  (3sec) **Options** for 3 seconds, and then Press **0** on the number pad.
2. Press **1** (On) or **2** (Off) on the number pad.
3. Press **START/SET** to save the changes.

## Using the Sabbath feature

(For use on the Jewish Sabbath & Holidays)









For further assistance, guidelines for proper usage, and a complete list of models with the Sabbath feature, please visit the web at <http://www.star-k.org>.

You can use the Sabbath feature with baking only. The oven temperature may be set higher or lower after you set the Sabbath feature. (The oven temperature adjustment feature should be used only during Jewish holidays.) The display, however, will not change and tones will not sound when a change occurs. Once the oven is properly set for baking with the Sabbath feature active, the oven will remain on continuously until the Sabbath feature is cancelled. This will override the factory preset 12-hour energy saving feature. If the oven light is needed during the Sabbath, press  before activating the Sabbath feature. Once the oven light is turned on and the Sabbath feature is active, the oven light will remain on until the Sabbath feature is turned off. If the oven light needs to be off, be sure to turn the oven light off before activating the Sabbath feature.

## How to use the Sabbath feature

1. Press **Bake**.  
The default temperature is 350 °F.
2. Enter the temperature you want, e.g., 375 °F, by using the number pad.
3. Press **START/SET**.  
The temperature display will start to change once the oven temperature reaches 175 °F.
4. Press **Bake** and **1** at the same time for 3 seconds.  
The display will show **SAb**.  
Once SAb appears in the display, the oven will not beep or display any further changes.  
You may change the oven temperature once baking has started. Remember that the oven will not beep or display any further changes once the Sabbath feature is engaged.
5. You can turn the oven off at any time by pressing **OFF/CLEAR**. This will turn only the oven off. If you want to deactivate the Sabbath feature, hold down **Bake** and **1** at the same time for 3 seconds. Sab will disappear from the display.

-  Do not attempt to activate any other program feature except BAKE while the Sabbath feature is active. ONLY the following key pads will function correctly with the Sabbath feature on: **Number, Bake, START/SET** and **OFF/CLEAR**. All other keys should not be used once the Sabbath feature is activated.
-  You can change the oven temperature, but the display will not change and tones will not sound when a change occurs. (The oven temperature adjustment feature should be used only on Jewish holidays.) After changing the temperature while the unit is in Sabbath mode, there is a 15-second delay before the unit recognizes the change.
-  You can set the Cook time function before activating the Sabbath feature.
-  Should you experience a power failure or interruption, the oven will shut off. When power is returned, the oven will not turn back on automatically. SAb will be displayed in the oven control display, but the oven will not operate. Food may be safely removed from the oven while it is still in the Sabbath mode, however the oven cannot be turned back on until after the Sabbath/Holidays. After the Sabbath observance, turn OFF the Sabbath mode. Press and hold both **Bake** and **1** for at least 3 seconds simultaneously to turn the Sabbath mode off. The oven can then be used with all normal functions.
-  Do not open the oven door or change the oven temperature for about 30 minutes after you have started Sabbath mode to allow the oven to reach the set temperature. Note that, for best performance, the oven fan operates only when the oven temperature is rising.
-  Do not cover the surface cooktop with a blech.

# Maintaining your appliance

## Self-cleaning

This self-cleaning oven uses high temperatures (well above cooking temperatures) to burn off leftover grease and residue completely or reduce them to a finely powdered ash that you can wipe away with a damp cloth.

### ⚠ CAUTION

- During the self-cleaning cycle, the outside of the range will become very hot to the touch. **Do not** leave small children unattended near the appliance.
- Some birds are extremely sensitive to the fumes given off during the self-cleaning cycle of any range. Move birds to another well-ventilated room.
- **Do not** line the oven walls, racks, bottom, or any other part of the range with aluminum foil. Doing so will result in poor heat distribution, poor baking results, and cause permanent damage to the oven interior. Aluminum foil will melt and adhere to the interior surface of the oven.
- **Do not** force the oven door open. This can damage the automatic door locking system. Use care when opening the oven door after the self-cleaning cycle is complete. Stand to the side of the oven when opening the door to allow hot air or steam to escape. The oven may still be **VERY HOT**.
- Wear the glove during cleaning.

### Before a self-cleaning cycle

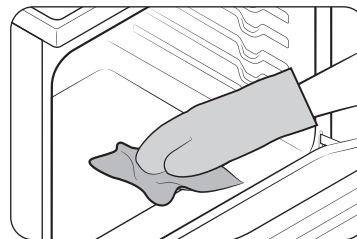

Fig. 1

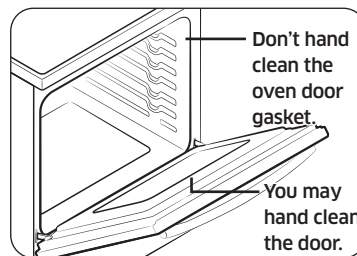

Fig. 2

- We recommend venting your kitchen with an open window or using a ventilation fan or hood during the self-cleaning cycle.
- Remove the wire rack, broil pan, broil pan insert, all cookware, and any aluminum foil from the oven.
- Wipe up debris from the oven bottom. (Fig. 1)
- The silver-colored oven racks can be self-cleaned, but they will darken, lose their luster, and become hard to slide.
- Residue on the front frame of the range and outside the gasket on the door will need to be cleaned by hand. Clean these areas with hot water, soap-filled steel-wool pads, or cleansers, such as Soft Scrub. Rinse well with clean water and dry.
- Do not clean the gasket. The fiberglass material of the oven door gasket cannot withstand abrasion. It is essential for the gasket to remain intact. If you notice it becoming worn or frayed, have it replaced. (Fig. 2)
- Make sure the oven light bulb cover is in place and the oven light is off.

### 📖 NOTE

Remove oven racks and accessories before starting the self-clean mode.

---

### How to run a self-cleaning cycle

1. Select the length of time for the self-cleaning operation, e.g., 3 hours.  
Press **Self Clean** once for a 3 hour clean time, twice for a 5 hour clean time, or 3 times for a 2 hour clean time  
The default setting is 3 hours.
2. Press **START/SET** to start the self-cleaning cycle.  
The motor-driven door lock will engage automatically.

#### NOTE

- You will not be able to start a self-cleaning cycle if the Oven lock feature is activated or if the oven's temperature is too hot.
  - The oven door locks automatically. The display will show the cleaning time remaining. It is not possible to open the oven door until the temperature drops to a safe and cool temperature.
  - The self-cleaning feature will not operate when the warming center is on.
3. When the self-cleaning cycle is done, End will appear in the display and the range will beep several times.

### How to delay the start of self-cleaning

1. Press **Self Clean**.  
Select the desired self-clean time by pressing **Self Clean**.
2. Press **Delay Start**.
3. Enter the time you want the clean cycle to start.
4. Press **START/SET**.  
The display will show Delay, Self clean, and the Lock icon. The motor-driven door lock will engage automatically.
5. The Self-Cleaning cycle will turn on automatically at the set time.

---

### How to turn off the self-cleaning feature

You may find it necessary to stop or interrupt a self-cleaning cycle due to smoke in the oven.

1. Press **OFF/CLEAR**.
2. You will be able to open the oven door once the oven has cooled down for approximately 1 hour.

### After a self-cleaning cycle

- You may notice some white ash in the oven. Wipe it up with a damp cloth after the oven cools. (If white spots remain, remove them with a soap-filled steel wool pad and rinse thoroughly with a vinegar and water mixture).
- If the oven is not clean after one cycle, repeat the cycle.
- You cannot set the oven for cooking until the oven is cool enough for the door to unlock.

# Maintaining your appliance

## Steam-cleaning

### How to set the oven for steam-cleaning

For light cleaning, the steam-cleaning function saves time and energy. For heavier-duty cleaning, use the self-cleaning function.



1. Remove all accessories from the oven.
2. Pour approximately 10 oz. (300 ml) of water onto the bottom of the empty oven and then close the oven door. Use normal water only, not distilled water.
3. Press **Steam Clean**.
4. Press **START/SET**.  
When the operation is complete, the display will blink and a beep will sound.
5. Press **OFF/CLEAR**.
6. Clean the oven's interior.  
There will be a significant amount of water remaining on the bottom of the oven after a steam-cleaning cycle. Remove the residual water with a sponge or soft dry cloth.

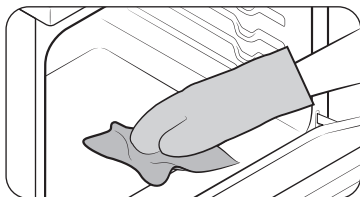

#### NOTE

When steam-cleaning, use exactly 10 oz. of water since this produces the best results.

#### NOTE

If you press **Steam Clean** when the oven temperature is above 100°F, **Hot** will appear in the display. Because this function produces the best results when started while the oven is cool, we recommend that you wait until the oven has cooled down and **Hot** disappears from the display.

#### CAUTION

Wear the glove during cleaning.

### After a steam-cleaning cycle

- Take care when opening the door before a steam-cleaning procedure has ended. The water on the bottom is hot.
- Open the oven door and remove the remaining water with a sponge. Do not leave the residual water in the oven for any length of time. Wipe the oven clean and dry with a soft cloth. Do not forget to wipe under the oven door seal.
- Use a detergent-soaked sponge, a soft brush, or a nylon scrubber to wipe the oven interior. Remove stubborn residue with a nylon scourer. You can remove lime deposits with a cloth soaked in vinegar.
- If the oven remains dirty, you can repeat the procedure once the oven has cooled.
- For heavy residue, such as grease left over from roasting, we recommend that you rub detergent into the residue before activating the steam-cleaning function.
- After cleaning, leave the oven door ajar at a 15° angle to allow the interior enamel surface to dry thoroughly.

## Care and cleaning of the oven

### ⚠ WARNING

- Be sure all controls are OFF and all surfaces are COOL before cleaning any part of the range.



- If your range is moved for cleaning, servicing, or any reason, be sure the Anti-Tip device is re-engaged properly when the range is replaced. If you fail to re-engage the Anti-Tip device, the range could tip and cause serious injury.

### Vent

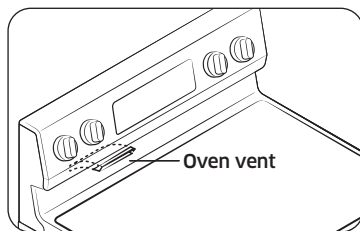

- The oven vent is located above the left rear surface unit.
- This area could become hot during oven use.
- It is normal for steam to come out of the vent.
- The vent is important for proper air circulation. **Never block this vent.**

### Cleaning painted parts and decorative trim

- For general cleaning, use a cloth with hot, soapy water.
- For more difficult residue and built-up grease, apply a liquid detergent directly onto the area and leave for 30 to 60 minutes. Wipe with a damp cloth and dry. Do not use abrasive cleaners on any of these surfaces. They can scratch.

### Cleaning stainless steel surfaces

1. Shake the bottle of STAINLESS STEEL APPLIANCE CLEANER or POLISH well.
2. Place a small amount of STAINLESS STEEL APPLIANCE CLEANER or POLISH on a damp cloth or damp paper towel.
3. Clean a small area, rubbing with the grain of the stainless steel if applicable.
4. Dry and buff with a clean, dry paper towel or soft cloth.
5. Repeat as necessary.

### 📖 NOTE

- **Do not use a steel-wool pad. It will scratch the surface.**
- If a mineral oil-based STAINLESS STEEL APPLIANCE CLEANER has been used before to clean the appliance, wash the surface with dishwashing liquid and water prior to using the STAINLESS STEEL APPLIANCE CLEANER or POLISH.

# Maintaining your appliance

## Oven racks

If the racks are left in the oven during a self-cleaning cycle, their color will turn slightly blue and the finish will be dull. After the self-cleaning cycle is complete and the oven has cooled, rub the sides of the racks with wax paper or a cloth containing a small amount of oil. This will help the racks glide more easily on their tracks.

### NOTE

- Do not clean in a dishwasher.
- If the rack becomes hard to remove or replace, lightly wipe the oven rack guides with cooking oil. Do not wipe cooking oil on the slides.
- If the rack becomes difficult to slide, the rack may need to be lubricated using a graphite lubricant.

### NOTE

- To order graphite lubricant., call Samsung customer care at 1-800-SAMSUNG (726-7864) or visit our homepage ([www.samsung.com/us/support](http://www.samsung.com/us/support), [www.samsung.com/ca/support](http://www.samsung.com/ca/support), or [www.samsung.com/ca\\_fr/support](http://www.samsung.com/ca_fr/support)) and reference part number DG81-01629A.
- If you want to buy directly, connect to <http://www.samsungparts.com/Default.aspx>.

## Air fry tray

To keep the Air fry tray clean, remove them from the cavity, and soak them in Lukewarm soapy water. Then, scour soil off of the Air fry tray using a plastic scouring pad.

### NOTE

The air fry tray is dishwasher-safe.

### CAUTION

Do not leave the air fry tray in the oven during the self-cleaning cycle. The extreme heat generated in this cycle can permanently peel off the air fry coating, their color will turn slightly blue and finish will be dull.

## Oven door

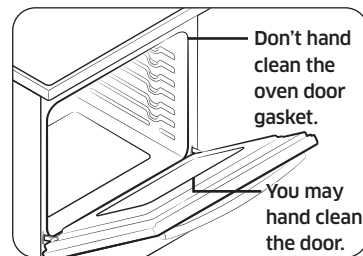

- Use soap and water to thoroughly clean the top, sides, and front of the oven door. Rinse well. You may use a glass cleaner on the outside glass of the oven door. DO NOT immerse the door in water. **DO NOT spray or allow water or the glass cleaner to enter the door vents.** DO NOT use oven cleaners, cleaning powders, or any harsh abrasive cleaning materials on the outside of the oven door.
- **DO NOT clean the oven door gasket.** The oven door gasket is made of a woven material, which is essential for a good seal. Care should be taken not to rub, damage, or remove this gasket.



## Care and cleaning of the glass cooktop

### ⚠ CAUTION

Do not block the vent and cooling motors or let any foreign matter get into them when cleaning the cooktop.

### Normal daily use cleaning

Use only a ceramic cooktop cleaner. Other creams may not be as effective. By following these steps, you can maintain and protect the surface of your glass cooktop.

1. Before using the cooktop for the first time, clean it with a ceramic cooktop cleaner. This helps protect the top and makes cleanup easier.
2. Daily use of a ceramic cooktop cleaner will help keep the cooktop looking new.
3. Shake the cleaning cream well. Apply a few drops of cleaner directly to the cooktop.
4. Use a paper towel or a cleaning pad for ceramic cooktops to clean the entire cooktop surface.
5. Use a dry cloth or paper towel to remove all cleaning residue. No need to rinse.

### ⚠ WARNING

**DAMAGE** to your glass surface may occur if you use scrub pads other than those recommended.

### Removing burned-on residue

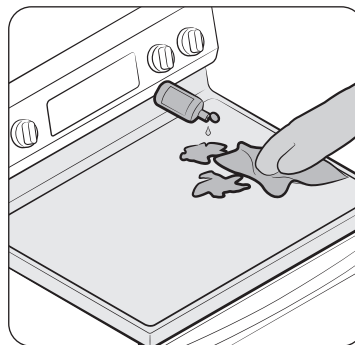

1. Allow the cooktop to cool.
2. Spread a few drops of ceramic cooktop cleaner on the entire burned residue area.
3. Using a cleaning pad for ceramic cooktops, rub the residue area, applying pressure as needed.
4. If any residue remains, repeat the steps listed above as needed.
5. For additional protection, after all residue has been removed, polish the entire surface by applying ceramic cooktop cleaner with a paper towel.

### Removing heavy, burned-on residue

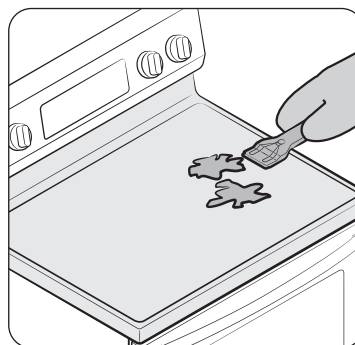

1. Allow the cooktop to cool.
2. Use a single-edge razor-blade scraper at approximately a 45° angle against the glass surface and scrape the soil. It will be necessary to apply pressure to remove the residue.
3. After scraping with the razor scraper, spread a few drops of ceramic cooktop cleaner on the entire burned residue area. Use a cleaning pad to remove any remaining residue. (Do not scrape the seal.)
4. For additional protection, after all residue has been removed, polish the entire surface by applying ceramic cooktop cleaner with a paper towel.

# Maintaining your appliance

## Removing metal marks and scratches

1. Be careful not to slide pots and pans across your cooktop. It will leave marks on the cooktop surface. You can remove these marks by applying ceramic cooktop cleaner with a cleaning pad for ceramic cooktops.
2. If pots with a thin overlay of aluminum or copper are allowed to boil dry, the overlay may leave black discoloration on the cooktop. You should remove this discoloration immediately or it may become permanent.

### **⚠ WARNING**

Carefully check the bottoms of pans for roughness that may scratch the cooktop.

## Cleaning the cooktop seal

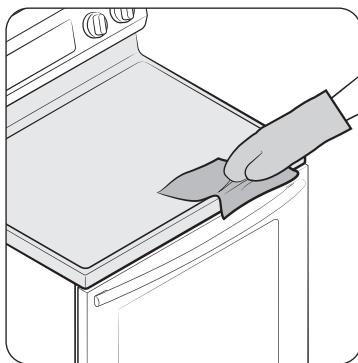

To clean the seal around the edges of the glass, lay a wet cloth on it for a few minutes, then wipe clean with a nonabrasive cleaner.

## Potential for permanent damage to the glass surface

- Sugary spillovers (such as jellies, fudge, candy, syrups) or melted plastics can cause pitting of the surface of your cooktop. This is not covered under the warranty. You should clean the spill while it is still hot. Take special care when removing hot substances. Refer to the section below.
- When using a scraper, be sure it is new and the razor blade is still sharp. Do not use a dull or nicked blade.

## Cleaning sugary spills and melted plastic

1. Turn off all surface units. Remove hot pans.
2. Wearing an oven mitt, use a single-edge razor blade scraper to move the spill to a cool area of the cooktop. Remove the spill with paper towels.
3. Any remaining spillover should be left until the surface of the cooktop has cooled.
4. Don't use the surface units again until all of the residue has been completely removed.

### **📄 NOTE**

If pitting or indentations in the glass surface have already occurred, the cooktop glass will have to be replaced. In this case, service will be necessary.

## Removing and reinstalling the oven door

### How to remove the door

#### ⚠ CAUTION

- The door is very heavy. Be careful when removing and lifting the door. Do not lift the door by the handle.
- Turn the power OFF before removing the door.

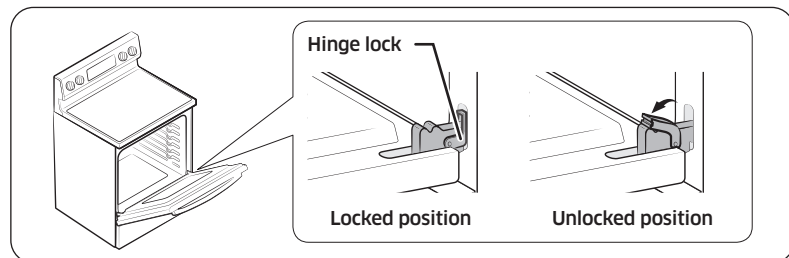

1. Open the door completely.
2. Pull the hinge locks down toward the door frame to the unlocked position.

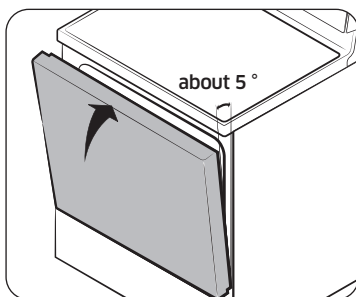

Fig. 1

3. Firmly grasp both sides of the door at the top.
4. Close the door to the door removal position, which is approximately 5 degrees from vertical (Fig. 1).

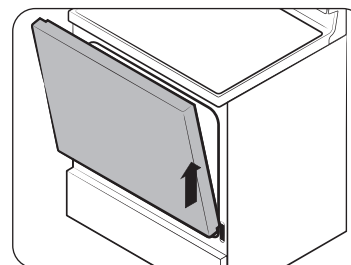
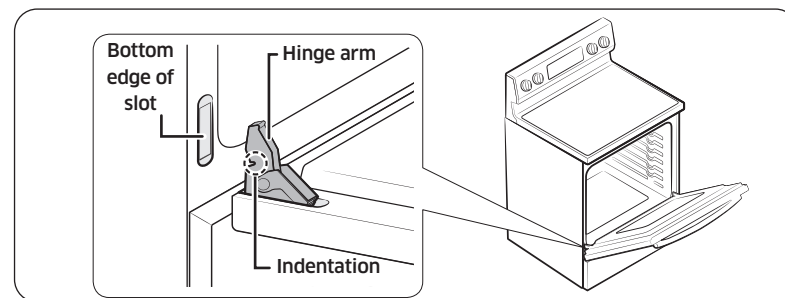

Fig. 2

5. Lift door up and out until the hinge arm is clear of the slot (Fig. 2).

### How to re-install the door



1. Firmly grasp both sides of the door at the top.
2. With the door at the same angle as the removal position, slide the indentation of the hinge arm into the bottom edge of the hinge slot. The notch in the hinge arm must be fully inserted into the bottom of the slot.

## Maintaining your appliance

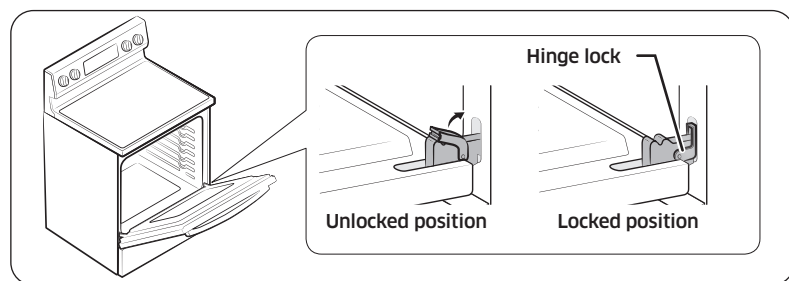

3. Open the door fully. If the door will not open fully, the indentation is not inserted correctly in the bottom edge of the slot.
4. Push the hinge locks up against the front frame of the oven cavity to the locked position.
5. Close the oven door.

## Removing and reinstalling the storage drawer

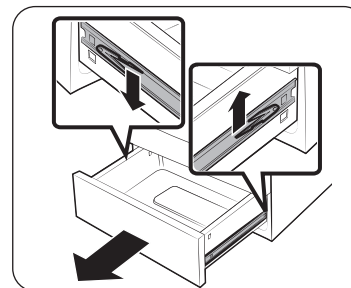

1. Slide open the drawer until it stops.
2. Locate the roller guide clips on either side. Using both hands, pull down the left clip while lifting the right clip, and then remove the drawer.
3. Clean the drawer in warm, soapy water using a cloth or soft brush. Then, rinse and dry it thoroughly.

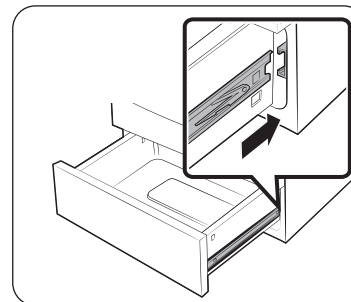

4. Put the drawer in the roller guides on either side, and then snap the clips into place.

## Changing the oven light

The oven light is a standard 40-watt appliance bulb. It will come on when the oven door is open. When the oven door is closed, press the  pad to turn it on or off. It will not work during a self-cleaning cycle.

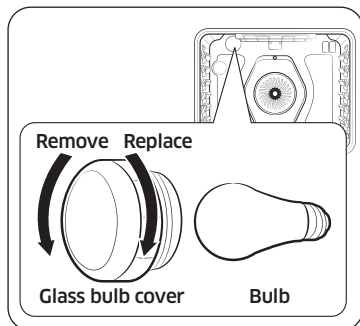

1. Make sure the oven and the bulb are cool.
2. Unplug the range or disconnect the power.
3. Turn the glass bulb cover in the back of the oven counterclockwise to remove.
4. Turn the bulb counterclockwise to remove it from its socket.
5. Insert a new 40 watt appliance bulb, and then turn it clockwise to tighten. Replace the bulb cover by turning clockwise.
6. Plug in the range or reconnect the power.

### CAUTION

- To prevent electric shock, make sure the oven is turned off and cool before replacing the oven light.
- When replacing the oven light, be careful not to damage the product due to excessive force.

## Troubleshooting

### Troubleshooting

Samsung works hard to ensure that you don't have problems with your new electric range. If you run into unexpected trouble, look first for a solution in the tables below. If you're still having trouble after trying the suggested solution, call Samsung at 1-800-SAMSUNG (1-800-726-7864).

#### Installation

Problem	Possible cause	Solution
The range is not level.	The appliance has been installed improperly.	<ul style="list-style-type: none"> <li>• Place the oven rack in the center of the oven. Place a level on the oven rack. Adjust the leveling legs at the base of the range until the oven rack is level.</li> <li>• Insure the floor is level and strong and stable enough to adequately support the range.</li> </ul>
	The floor is sagging or sloping.	Contact a carpenter to correct the situation.
	The kitchen cabinets are not properly aligned and make the range appear to be not level.	Insure the cabinets are square and provide sufficient room for installation.
The appliance must be accessed for servicing and cannot be moved easily.	The kitchen cabinets are not square and too close to the appliance.	Contact a builder or installer to make the appliance accessible.
	Carpet is interfering with movement of the range.	Provide sufficient space so the range can be lifted over the carpet.

# Troubleshooting

## CONTROL DISPLAY

Problem	Possible cause	Solution
The display goes blank.	A fuse in your home may be blown or the circuit breaker tripped.	Replace the fuse or reset the circuit breaker.
The display flashes.	There was a power failure.	Reset the clock.

## COOKTOP

Problem	Possible cause	Solution
The surface units will not maintain a rolling boil or will not cook fast enough.	You may be using inappropriate cookware.	Use pans that are flat and match the diameter of the surface unit selected.
	In some areas, the power (voltage) may be low.	Cover the pan with a lid until the desired heat is obtained.
The surface units will not turn on.	A fuse in your home may be blown or a circuit breaker may have tripped.	Replace the fuse or reset the circuit breaker.
	The cooktop controls are set improperly.	Check if the correct control is set for the surface unit you are using.
Areas of discoloration on the cooktop.	Food spillover was not cleaned.	Refer to the section on the care and cleaning of the glass cooktop on page 49.
	The surface is hot and the model features a light-colored cooktop.	This is normal. The surface may appear discolored when it is hot. This is temporary and will disappear as the glass cools.

Problem	Possible cause	Solution
The surface unit frequently cycles on and off.	The element will cycle on and off to maintain the power setting.	This is normal operation, and not a system failure. Use the range as usual.
The surface unit stops glowing when changed to a lower setting.	This is normal. The unit is still on and hot.	
Scratches or abrasions on the cooktop surface.	The cooktop is being cleaned improperly.	Scratches are not removable. Tiny scratches will become less visible in time as a result of cleaning. Use ceramic glass top cleaning cream. Do not use chemical or corrosive agents. These agents may damage the surface of the product.
	Cookware with rough bottoms was used on the cooktop or there were coarse particles (e.g., salt or sand) present between the cookware and the surface of the cooktop.	To avoid scratches, follow the recommended cleaning procedures. Make sure cookware bottoms are clean before use, and use cookware with smooth bottoms.
	Cookware has been slid across the cooktop surface.	

Problem	Possible cause	Solution
Brown streaks or specks.	Boilovers have been cooked onto the surface.	<ul style="list-style-type: none"> <li>Wait until the surface cools down. Then, use a single-edge razor-blade scraper at approximately a 45° angle against the glass surface to remove the soil.</li> <li>See the section on the care and cleaning of the glass cooktop on page 49.</li> </ul>
Areas of discoloration with metallic sheen.	Mineral deposits from water and food have been left on the surface of the cooktop.	<ul style="list-style-type: none"> <li>Remove using a ceramic-glass cooktop cleaning cream.</li> <li>Use cookware with clean, dry bottoms. Clean the cooktop with a ceramic cleaning agent regularly every week.</li> </ul>
"Cracking" or "popping" sound.	This is the sound of the metal heating and cooling during both the cooking and self-cleaning functions.	This is normal operation, and not a system failure. Use the range as usual.

## OVEN

Problem	Possible cause	Solution
The oven will not turn on.	The range is not completely plugged into the electrical outlet.	Make sure the electrical plug is inserted into a live, properly grounded outlet.
	A fuse in your home may be blown or a circuit breaker may have tripped.	Replace the fuse or reset the circuit breaker.
	The oven controls have been set improperly.	See the chapter on operating the oven starting on page 28.
	The oven is too hot.	Allow the oven to cool.
	Incomplete service wiring.	Call for service.
	Power outage.	Check to see if the house lights will turn on. If necessary, call your local electric company for service.
The oven light will not turn on.	The light bulb is loose or defective.	Tighten or replace the bulb.
	The switch operating the light is broken.	Call for service.

# Troubleshooting

Problem	Possible cause	Solution
The appliance will not turn on.	The appliance is not completely plugged into the electrical outlet or a fuse in your home may be blown or a circuit breaker may have tripped.	Make sure the power cord is plugged into a live, properly grounded outlet. Check the fuse and circuit breakers.
	Incomplete service wiring.	Call for service.
	Power outage.	Check to see if the house lights will turn on. If necessary, call your local electric company for service.
The oven smokes excessively during broiling.	The oven controls have not been set properly.	Refer to the section on using the broiler starting on page 35.
	The meat has been placed too close to the element.	Reposition the rack to provide proper clearance between the meat and the element. Preheat the broil element for searing.
	The meat has not been properly prepared.	Remove the excess fat from the meat. Cut away fatty edges that may curl, leaving the lean intact.
	Grease has built up on oven surfaces.	Regular cleaning is necessary when broiling frequently.

Problem	Possible cause	Solution
Food does not bake or roast properly.	The oven controls have not been set correctly.	See the chapter on operating the oven starting on page 28.
	The oven rack has been positioned incorrectly or is not level.	See the section on using the oven racks on page 31.
	Incorrect cookware or cookware of improper size is being used.	
	The oven sensor needs to be adjusted.	See the section on adjusting the thermostat on page 41.
Food does not broil properly.	The serving size may not be appropriate.	Refer to the cooking guide for serving sizes on page 35, and then try again.
	The rack has not been properly positioned.	See the broiling recommendation guide on page 35.
	The cookware is not suited for broiling.	Use suitable cookware.
	In some areas, the power (voltage) may be low.	<ul style="list-style-type: none"> <li>Preheat the broil element for 10 minutes.</li> <li>See the broiling recommendation guide on page 35.</li> </ul>
The oven temperature is too hot or too cold.	The oven sensor needs to be adjusted.	See the section on adjusting the thermostat on page 41.



Problem	Possible cause	Solution
The oven will not self-clean.	The oven temperature is too high to start a self-clean operation.	Allow the range to cool and then reset the controls.
	The oven controls have been set incorrectly.	See the section on self-cleaning on page 44.
	A self-cleaning cycle cannot be started if the oven lock feature has been activated or if a radiant surface element is on.	Deactivate the oven lock (see page 29). Make sure all surface elements are turned off.
Excessive smoking during a self-cleaning cycle.	There is excessive soiling in the oven.	Press <b>OFF/CLEAR</b> . Open the windows to rid the room of smoke. Wait until the self-cleaning cycle is cancelled. Wipe up the excessive soil and then start the self-cleaning cycle again.
The oven door will not open after a self-cleaning cycle.	The oven is too hot.	Allow the oven to cool.
The oven is not clean after a self-cleaning cycle.	The oven controls were not set correctly.	See the section on self-cleaning on page 44.
	The oven was heavily soiled.	Wipe up heavy spillovers before starting the self-cleaning cycle. Heavily soiled ovens may need to be self-cleaned again or for a longer period of time.

Problem	Possible cause	Solution
Steam is coming out of the vent.	When using the convection feature, it is normal to see steam coming out of the oven vent.	This is normal operation and not a system failure. Use the range as usual.
	As the number of racks or amount of food being cooked increases, the amount of visible steam will increase.	
A burning or oily odor is coming from the vent.	This is normal in a new oven and will disappear in time.	<ul style="list-style-type: none"> <li>To speed the process, set a self-cleaning cycle for a minimum of 3 hours.</li> <li>See the section on self-cleaning on page 44.</li> </ul>
Strong odor.	An odor coming from the insulation around the inside of the oven is normal for the first few times the oven is used.	Operate the oven empty on the bake setting at 400 °F for 1 hour.
Fan noise.	A convection fan may automatically turn on and off.	This is not a system failure but normal operation.
Oven racks are difficult to slide.	The shiny, silver-colored racks were cleaned in a self-cleaning cycle.	Apply a small amount of vegetable oil to a paper towel, and then wipe the edges of the oven racks with the paper towel.

# Troubleshooting

## DRAWER

Problem	Possible cause	Solution
The drawer does not slide smoothly or drags.	The drawer is out of alignment.	Fully extend the drawer and push it all the way in. See the page 52.
	The drawer is overloaded or the load is unbalanced.	Reduce weight. Redistribute drawer contents.
Excessive condensation in the drawer.	There is liquid present in the drawer.	Remove the liquid.
	Uncovered foods.	Cover food with a lid.

## Information codes

### OVEN

Displayed Code	Possible cause	Solution
C-d0	There is a short in the control key.	Press <b>OFF/CLEAR</b> , and then restart the oven. If the problem persists, disconnect all power to the range for at least 30 seconds and then reconnect the power. If this does not solve the problem, call for service.
C-d1	The door lock is misaligned.	
C-F2	This code occurs if communication between the Main and Touch is interrupted.	Press <b>OFF/CLEAR</b> , and then restart the oven. If the problem persists, disconnect all power to the range for at least 30 seconds and then reconnect the power. If this does not solve the problem, call for service.
C-20	The oven sensor is open when the oven is operating. There is a short in the Oven sensor.	
C-21	This code occurs if the internal temperature rises abnormally high.	Press <b>OFF/CLEAR</b> , and then restart the oven. If the problem persists, disconnect all power to the range for at least 30 seconds and then reconnect the power. If this does not solve the problem, call for service.
C-30	The main PCB sensor is open when the oven is operating. There is a short in the main PCB sensor.	
C-31	This code occurs if the PCB temperature rises abnormally high.	Call for service.
bAd LinE	This error message appears if the power cord is installed improperly.	If the power connection is plugged in improperly, "bAd LinE" appears on the display. Reconnect the power connection properly, and the message disappears.

# Warranty (U.S.A)

PLEASE DO NOT DISCARD. THIS PAGE REPLACES THE WARRANTY PAGE IN THE  
USE & CARE GUIDE

## SAMSUNG ELECTRIC RANGE

### LIMITED WARRANTY TO ORIGINAL PURCHASER WITH PROOF OF PURCHASE

This SAMSUNG brand product, as supplied and distributed by SAMSUNG ELECTRONICS AMERICA, INC. (SAMSUNG) and delivered new, in the original carton to the original consumer purchaser, is warranted by SAMSUNG against manufacturing defects in materials or workmanship for the limited warranty period, starting on the date of delivery to the original consumer purchaser, of:

#### One (1) Year Parts and Labor

This limited warranty is valid only on products purchased and used in the United States that have been installed, operated, and maintained according to the instructions attached to or furnished with the product. To receive warranty service, the purchaser must contact SAMSUNG at the address or phone number provided below for problem determination and service procedures. Warranty service can only be performed by a SAMSUNG authorized service center. The original dated bill of sale and/or proof of delivery must be presented upon request as proof of purchase to SAMSUNG or SAMSUNG's authorized service center to receive warranty service.

SAMSUNG will provide in-home service within the contiguous United States during the warranty period at no charge, subject to availability of SAMSUNG authorized servicers within the customer's geographic area. If in-home service is not available, SAMSUNG may elect, at its option, to provide transportation of the product to and from an authorized service center. If the product is located in an area where service by a SAMSUNG authorized servicer is not available, you may be responsible for a trip charge or required to bring the product to a SAMSUNG authorized service center for service.

To receive in-home service, product must be unobstructed and accessible to the service agent.

During the applicable warranty period, a product will be repaired, replaced, or the purchase price refunded, at the sole option of SAMSUNG. SAMSUNG may use new or reconditioned parts in repairing a product, or replace the product with a new or reconditioned product. Replacement parts and products are warranted for the remaining portion of the original product's warranty or ninety (90) days, whichever is longer. All replaced parts and products are the property of SAMSUNG and you must return them to SAMSUNG.

This limited warranty covers manufacturing defects in materials or workmanship encountered in normal household, noncommercial use of this product and shall not cover the following: damage that occurs in shipment, delivery, installation, and uses for which this product was not intended; damage caused by unauthorized modification or alteration of the product; product where the original factory serial numbers have been removed, defaced, changed in any way, or cannot be readily determined; cosmetic damage including scratches, dents, chips, and other damage to the product's finishes; damage caused by abuse, misuse, pest infestations, accident, fire, floods, or other acts of nature or God; damage caused by use of equipment, utilities, services, parts, supplies, accessories, applications, installations, repairs, external wiring or connectors not supplied or authorized by SAMSUNG; damage caused by incorrect electrical line current, voltage, fluctuations and surges; damage caused by failure to operate and maintain the product according to instructions; in-home instruction on how to use your product; and service to correct installation not in accordance with electrical or plumbing codes or correction of household electrical or plumbing (i.e., house wiring, fuses, or water inlet hoses). In addition, damage to the glass cooktop caused by (i) use of cleaners other than the recommended cleaners and pads or (ii) hardened spills of sugary materials or melted plastic that are not cleaned according to the directions in the use and care guide are not covered by this limited warranty.

The cost of repair or replacement under these excluded circumstances shall be the customer's responsibility.

Visits by an authorized servicer to explain product functions, maintenance or installation are not covered by this limited warranty. Please contact SAMSUNG at the number below for assistance with any of these issues.

## Warranty (U.S.A)

---

### EXCLUSION OF IMPLIED WARRANTIES

IMPLIED WARRANTIES, INCLUDING THE IMPLIED WARRANTIES OF MERCHANTABILITY OR FITNESS FOR A PARTICULAR PURPOSE, ARE LIMITED TO ONE YEAR OR THE SHORTEST PERIOD ALLOWED BY LAW. Some states do not allow limitations on how long an implied warranty lasts, so the above limitations or exclusions may not apply to you. This warranty gives you specific rights, and you may also have other rights, which vary from state to state.

### LIMITATION OF REMEDIES

YOUR SOLE AND EXCLUSIVE REMEDY IS PRODUCT REPAIR, PRODUCT REPLACEMENT, OR REFUND OF THE PURCHASE PRICE AT SAMSUNG'S OPTION, AS PROVIDED IN THIS LIMITED WARRANTY. SAMSUNG SHALL NOT BE LIABLE FOR SPECIAL, INCIDENTAL OR CONSEQUENTIAL DAMAGES, INCLUDING BUT NOT LIMITED TO TIME WAY FROM WORK, HOTELS AND/OR RESTAURANT MEALS, REMODELING EXPENSES, LOSS OF REVENUE OR PROFITS, FAILURE TO REALIZE SAVINGS OR OTHER BENEFITS REGARDLESS OF THE LEGAL THEORY ON WHICH THE CLAIM IS BASED, AND EVEN IF SAMSUNG HAS BEEN ADVISED OF THE POSSIBILITY OF SUCH DAMAGES. Some states do not allow exclusion or limitation of incidental or consequential damages, so the above limitations or exclusions may not apply to you. This warranty gives you specific rights, and you may also have other rights, which vary from state to state.

SAMSUNG does not warrant uninterrupted or error-free operation of the product. No warranty or guarantee given by any other person, firm, or corporation with respect to this product shall be binding on SAMSUNG.

To obtain warranty service, please contact SAMSUNG at:

Samsung Electronics America, Inc.  
85 Challenger Road  
Ridgefield Park, NJ 07660  
1-800-SAMSUNG (726-7864) and [www.samsung.com/us/support](http://www.samsung.com/us/support)

## Warranty (CANADA)

---

**PLEASE DO NOT DISCARD. THIS PAGE REPLACES THE WARRANTY PAGE IN THE USE & CARE GUIDE**

### SAMSUNG ELECTRIC RANGE

#### LIMITED WARRANTY TO ORIGINAL PURCHASER

This SAMSUNG brand product, as supplied and distributed by SAMSUNG ELECTRONICS CANADA, INC. (SAMSUNG) and delivered new, in the original carton to the original consumer purchaser, is warranted by SAMSUNG against manufacturing defects in materials and workmanship for a limited warranty period of:

#### **One (1) Year Parts and Labor, One (1) Year Parts Warranty For Glass Cooktop and Radiant Heater**

This limited warranty begins on the original date of purchase, and is valid only on products purchased and used in the CANADA. To receive warranty service, the purchaser must contact SAMSUNG for problem determination and service procedures. Warranty service can only be performed by a SAMSUNG authorized service center. The original dated bill of sale must be presented upon request as proof of purchase to SAMSUNG or SAMSUNG's authorized service center. Samsung will provide in-home service during the warranty period at no charge subject to availability within the contiguous CANADA. In home service is not available in all areas. To receive in home service product must be unobstructed and accessible to the service agent. If service is not available Samsung may elect to provide transportation of the product to and from an authorized service center.

---

SAMSUNG will repair or replace this product, at our option and at no charge as stipulated herein, with new or reconditioned parts or products if found to be defective during the limited warranty period specified above. All replaced parts and products become the property of SAMSUNG and must be returned to SAMSUNG. Replacement parts and products assume the remaining original warranty, or ninety (90) days, whichever is longer. This limited warranty covers manufacturing defects in materials and workmanship encountered in normal, noncommercial use of this product and shall not apply to the following: damage which occurs in shipment; delivery and installation; applications and uses for which this product was not intended; altered product or serial numbers; cosmetic damage or exterior finish; accidents, abuse, neglect, fire, water, lightning or other acts of nature; use of products, equipment, systems, utilities, services, parts, supplies, accessories, applications, installations, repairs, external wiring or connectors not supplied or authorized by SAMSUNG which damage this product or result in service problems; incorrect electrical line voltage, fluctuations and surges; customer adjustments and failure to follow operating instructions, maintenance and environmental instructions that are covered and prescribed in the instruction book; product removal and reinstallation; problems caused by pest infestations, and overheating or overcooking by user. This limited warranty shall not cover cases of incorrect electric current, voltage or supply, light bulbs, house fuses, house wiring, cost of a service call for instructions, or fixing installation errors. Furthermore, damage to the glass cooktop caused by the use of cleaners other than the recommended cleaners and pads, damage to the glass cook top caused by hardened spills of sugary materials or melted plastic that are not cleaned according to the directions in the use and care guide are not covered. SAMSUNG does not warrant uninterrupted or error-free operation of the product.

---

EXCEPT AS SET FORTH HEREIN THERE ARE NO WARRANTIES ON THIS PRODUCT EITHER EXPRESS OR IMPLIED AND SAMSUNG DISCLAIMS ALL WARRANTIES INCLUDING, BUT NOT LIMITED TO, ANY IMPLIED WARRANTIES OF MERCHANTABILITY, INFRINGEMENT OR FITNESS FOR A PARTICULAR PURPOSE. NO WARRANTY OR GUARANTY GIVEN BY ANY PERSON, FIRM OR CORPORATION WITH RESPECT TO THIS PRODUCT SHALL BE BINDING ON SAMSUNG. SAMSUNG SHALL NOT BE LIABLE FOR LOSS OF REVENUE OR PROFITS, FAILURE TO REALIZE SAVINGS OR OTHER BENEFITS, OR ANY OTHER SPECIAL, INCIDENTAL OR CONSEQUENTIAL DAMAGES CAUSED BY THE USE, MISUSE OR INABILITY TO USE THIS PRODUCT, REGARDLESS OF THE LEGAL THEORY ON WHICH THE CLAIM IS BASED, AND EVEN IF SAMSUNG HAS BEEN ADVISED OF THE POSSIBILITY OF SUCH DAMAGES. NOR SHALL RECOVERY OF ANY KIND AGAINST SAMSUNG BE GREATER IN AMOUNT THAN THE PURCHASE PRICE OF THE PRODUCT SOLD BY SAMSUNG AND CAUSING THE ALLEGED DAMAGE. WITHOUT LIMITING THE FOREGOING, PURCHASER ASSUMES ALL RISK AND LIABILITY FOR LOSS, DAMAGE OR INJURY TO PURCHASER AND PURCHASER'S PROPERTY AND TO OTHERS AND THEIR PROPERTY ARISING OUT OF THE USE, MISUSE OR INABILITY TO USE THIS PRODUCT. THIS LIMITED WARRANTY SHALL NOT EXTEND TO ANYONE OTHER THAN THE ORIGINAL PURCHASER OF THIS PRODUCT, IS NONTRANSFERABLE AND STATES YOUR EXCLUSIVE REMEDY.

Some states do not allow limitations on how long an implied warranty lasts, or the exclusion or limitation of incidental or consequential damages, so the above limitations or exclusions may not apply to you. This warranty gives you specific legal rights, and you may also have other rights which vary from state to state. To obtain warranty service, please contact SAMSUNG at:

**Samsung Electronics Canada Inc.**  
2050 Derry Road West, Mississauga, Ontario L5N 0B9 Canada  
1-800-SAMSUNG (726-7864) and [www.samsung.com/ca/support](http://www.samsung.com/ca/support) (English)  
[www.samsung.com/ca\\_fr/support](http://www.samsung.com/ca_fr/support) (French)

# Appendix

---

## Open Source Announcement

---

The software included in this product contains open source software.

The following URL [http://opensource.samsung.com/opensource/SMART\\_TP2\\_0/seq/0](http://opensource.samsung.com/opensource/SMART_TP2_0/seq/0) leads to open source license information as related to this product.



# Memo

---

**Memo**

---



Scan the QR code\* or visit [www.samsung.com/spsn](http://www.samsung.com/spsn) to view our helpful How-to Videos and Live Shows

\*Requires reader to be installed on your smartphone

Scan this with your smartphone

Please be advised that the Samsung warranty does NOT cover service calls to explain product operation, correct improper installation, or perform normal cleaning or maintenance.

#### QUESTIONS OR COMMENTS?

COUNTRY	CALL	OR VISIT US ONLINE AT
U.S.A Consumer Electronics	1-800-SAMSUNG (726-7864)	<a href="http://www.samsung.com/us/support">www.samsung.com/us/support</a>
CANADA	1-800-SAMSUNG (726-7864)	<a href="http://www.samsung.com/ca/support">www.samsung.com/ca/support</a> (English) <a href="http://www.samsung.com/ca_fr/support">www.samsung.com/ca_fr/support</a> (French)

