

MAS486BTFEPXT

MASTER SERIES DUAL-FUEL RANGE 48" - 6 BRASS BURNERS + ELECTRIC GRIDDLE - SELF-CLEAN OVEN - STAINLESS STEEL FINISH



Exclusive Finish and Materials

Metal knobs and handles make the range a standout in every kitchen. Stainless toe-kick included with the range. Optional Décor Sets knobs and handles in contrasting metals - satin gold and black nickel - for aesthetic customization.

Bertazzoni signature counter-deep maintop

Bertazzoni signature stainless counter-deep maintop is designed to install flush with most kitchen countertops for a perfectly integrated look. Precise and flexible heating is generated through 6 Mono-bloc brass burners. 2 x 19000 BTUs power burners with dual ring of flame boil water in 6 minutes flat. The stainless steel electric griddle comes with a handy integrated cover.

Extra large oven with dual convection

The 4.6 cu.ft electric self-clean oven with dual diagonal convection allows even baking and roasting on 7 shelf levels. A 2.4 cu.ft auxiliary electric oven with broiler helps prepare multiple dishes at the same time. Bertazzoni ovens are equipped with an extra-large high-power broiler for broiling and grilling.

Advanced programming and controls for the oven

The elegant digital gauge gives precise control of oven temperature during pre-heating, roasting and baking, and has integrated controls for the food temperature probe. This range comes with a dedicated air-frying mode for healthier cooking, to be used with the included stainless steel mesh basket.

Best-in-class features and design

The soft-close oven door with edge-to-edge tempered glass is a masterpiece of European engineering and makes the oven door very easy to wipe clean. Convenient smooth-glide telescopic racks on 2 levels help loading and unloading the oven.

GENERAL CHARACTERISTICS

Worktop	6 gas burners with 2 lateral dual wok + elec. griddle
Burners	Brass burners
Pan support	Cast iron
Upstand/Lid cover	1" stainless steel island trim
Knobs	Metal
Cooking modes	10
Tray	1 baking tray w/grill trivet + 1 air fry basket
Shelves	2 heavy duty
Levels	Laterals grids
Telescopic guides	2 sliding guides
Inner door	Squared 3 glasses
Door hinges	Soft closing
Auxiliary oven cooking modes	5
Auxiliary oven shelves	2 heavy duty
Auxiliary oven levels	Laterals grids
Auxiliary oven telescopic guides	2 sliding guides
Legs	Stainless steel ø 2 3/8 inches

TECHNICAL SPECIFICATIONS

Electrical requirements	120/208 V 60HZ - 6800W 120/240 V 60HZ - 8500W 40A
Warranty	2 years parts & labor
Packaging dimensions	H:42 1/8 W:51 15/16 D:29 15/16

MAS486BTFFPXT

MASTER SERIES DUAL-FUEL RANGE 48" - 6 BRASS BURNERS + ELECTRIC GRIDDLE - SELF-CLEAN OVEN - STAINLESS STEEL FINISH



DIMENSIONS

SIDE VIEW



FRONT VIEW

LEG DETAILS

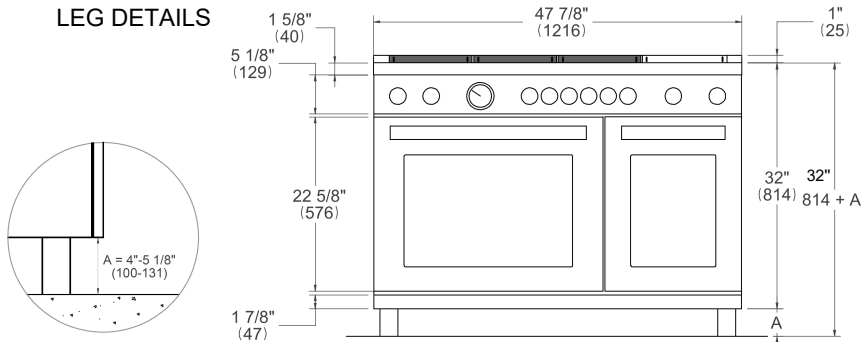

WORKTOP DETAILS

REAR VIEW

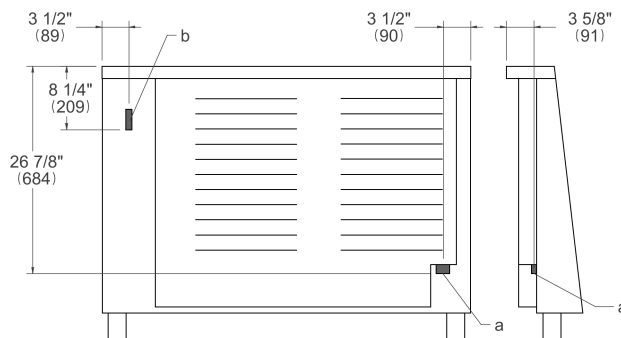
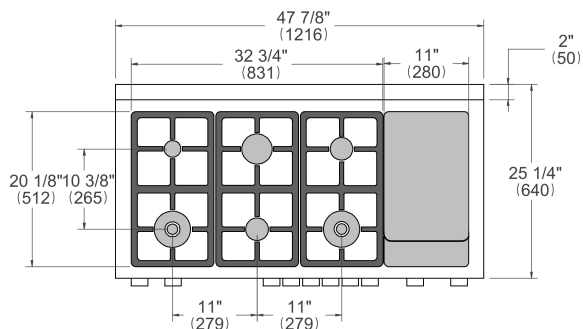

INSTALLATION

E A properly-grounded horizontally mounted electrical receptacle should be installed no higher than 3" (7.6 cm) above the floor, no less than 2" (5 cm) and no more than 8" (20,3 cm) from the left side (facing product). Check all local code requirements.

G Install agency approved, properly sized manual shut-off valve at max. height of 3" from floor, 2" min. height/ 8" max. height from the right side (facing product). Use approved shut-off valve & regulator gas connection, properly sized flex or rigid pipe. Check all local code requirements.

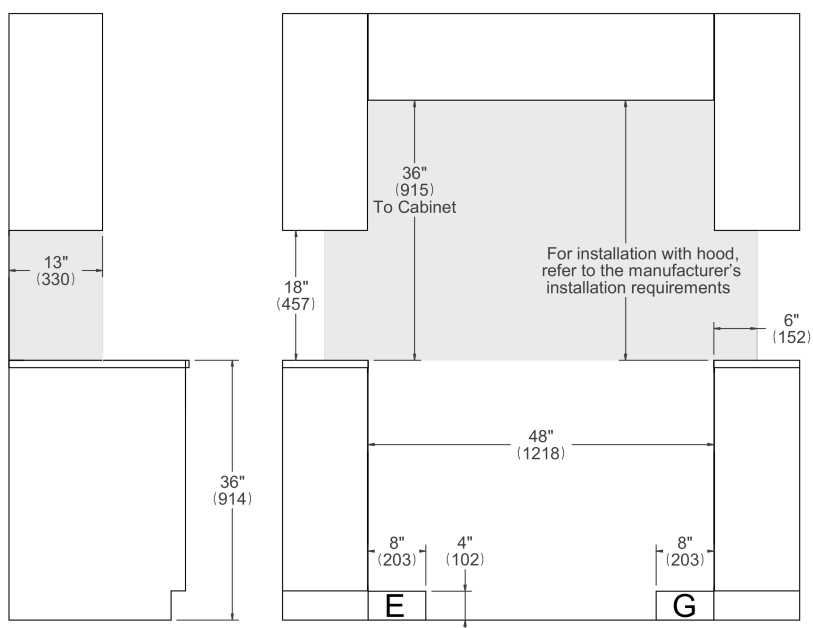

NOTE

a. Electrical Connection
b. Gas Connection

Disclaimer: while every effort has been made to insure the accuracy of the information contained in this document, Fratelli Bertazzoni reserves the right to change any part of the information at any time without notice. For detailed installation specifications consult the installation manual. Fratelli Bertazzoni, Bertazzoni and the winged wheel brand icon are registered trademarks of Bertazzoni Spa.