

KM 3474 G

36-inch gas cooktop

with 2 dual wok burners for particularly versatile cooking convenience.



- Simple controls -single-handed operation via rotary dial control
- Professional design – 36 (914) in (mm) wide stainless steel trough
- Particularly versatile – 5 burners incl. Two dual woks
- Extremely safe – GasStop function
- Easy cleaning – ComfortClean dishwasher-safe grates

EAN: 4002514141039 / Material number: 06792760 / Old Material Number: 26347450USA

Heating type	
Fuel type	Gas
Design	
Independent of oven	•
Design	
Cast iron pot rests (matte black enameled)	•
Stainless steel trough	•
Cooking zone details	
No. of rings	5
Gas burner power rating	
Normal burner in kW	2.60
Normal burner in BTU/h	9000
Large burner in kW	3.50
Large burner in BTU/h	12000
Dual wok burner in kW	4.50
Dual wok burner in BTU/h	15300
1st cooking zone/cooking area	
Position	front left
Type	Dual wok burner
2nd cooking zone/cooking area	
Position	rear left
Type	Standard burner
3rd cooking zone/cooking area	
Position	rear center
Type	High-speed burner
4th cooking zone/cooking area	
Position	rear right
Type	Standard burner
5th cooking zone/cooking area	
Position	front right
Type	Dual wok burner
User convenience	
Operation via knobs	•
Electronic ignition with one-handed operation	•
QuickStart	•
Safety	
GasStop & ReStart	•
Technical data	
Dimensions (H x W x D) in inches (mm)	
Dimensions (width) in in. (mm)	36 (914)
Dimensions (height) in in. (mm)	5 (125)
Dimensions in mm (depth)	21 3/8 (542)
Cutout dimensions (width) in in. (mm)	35 (889)
Cutout dimensions (depth) in in. (mm)	20 1/2 (518)
Weight in lbs. (kg)	55 (25)
Total connected load in kW	17.00
Power cord length in in. (m)	3 (1.2)
Position of gas connection	Hinten links
Voltage in V	120
Frequency in Hz	60

KM 3474 G
36-inch gas cooktop
with 2 dual wok burners for particularly versatile cooking convenience.



EAN: 4002514141039 / Material number: 06792760 / Old Material Number: 26347450USA

Standard accessories

Power cord

No

KM 3474 G

36-inch gas cooktop

with 2 dual wok burners for particularly versatile cooking convenience.

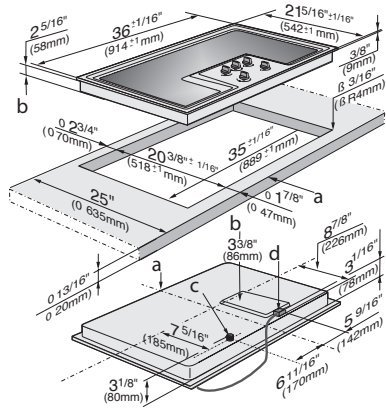

KM 3474/KM3475 (Installation Drawing) – USA

1. Front, 2. Installation height, 3. Gas connection, 4. Electrical connection