

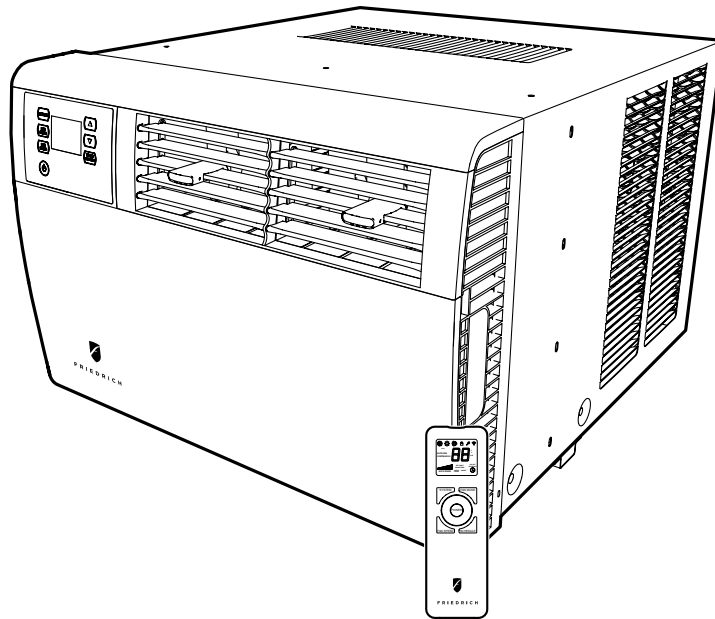

Kühl® Q Room Air Conditioners R410A Refrigerant



Q Chassis Models

Kühl

115-Volt: KCQ06A10A, KCQ08A10A, KCQ10A10A,
KCQ10A10B

Kühl +

Electric Heat

115-Volt: KEQ08A11A

THE EXPERTS IN ROOM AIR CONDITIONING

Table of Contents	
INTRODUCTION	3
Important Safety Information	3
Personal Injury Or Death Hazards	4
Kühl Control Options	6
Component Identification	7
User Interface	7
Model and Serial Number Location	7
Model Number Reference Guide	8
Serial Number Reference Guide	9
SPECIFICATIONS	10
Refrigeration Systems Performance Data	10
Installation	11
Electrical Data	12
Circuit Rating/ Breaker/ power cord/ wall Receptacle	12
OPERATION	14
Airflow Direction	14
User Interface	15
Control Panel	27
Remote Control	28
Unit	29
General Knowledge Sequence Of Refrigeration	32
ROUTINE MAINTENANCE	33
REMOVE AND INSTALL THE FRONT COVER	33
REMOVE AND INSTALL THE CHASSIS	36
TROUBLESHOOTING	37
Diagnostic Codes	38
Tips	39
COMPONENT TESTING	45
Compressor Checks	45
Capillary Tube Assy (Cool Only Units)	47
Capacitors	48
Heating Element	49
Drain Pan Valve	49
Testing the User Interface and Electronic Control Board	50
Thermistors Description	50
Replace the Electronic Control Board	52
Replace the User Interface	52
R-410A SEALED SYSTEM REPAIR	53
Undercharged Refrigerant Systems	55
Overcharged Refrigerant Systems	56
Restricted Refrigerant System	57
Sealed System Method of Charging/ Repairs	58
Compressor Replacement	59
Compressor Replacement -Special Procedure in Case of Compressor Burnout	60
WIRING DIAGRAMS	61
Available Accessories	63
APPENDIX	64
Thermistor Resistance Values (This Table Applies to All Thermistors)	64
Interactive Parts Viewer	65
Limited Warranty	65
Friedrich Authorized Parts Depots	66

INTRODUCTION

Important Safety Information

The information in this manual is intended for use by a qualified technician who is familiar with the safety procedures required for installation and repair, and who is equipped with the proper tools and test instruments required to service this product.

Maintenance is the responsibility of the owner. Failure to properly maintain or repair equipment may result in personal injury and/or various types of property damage (fire, flood, etc.).





Installation or repairs made by unqualified persons can result in subjecting the unqualified person making such repairs as well as the persons being served by the equipment to hazards resulting in injury or electrical shock which can be serious or even fatal.

Safety warnings have been placed throughout this manual to alert you to potential hazards that may be encountered. If you install or perform service on equipment, it is your responsibility to read and obey these warnings to guard against any bodily injury or property damage which may result to you or others.

Due to continuing research in new energy-saving technology, all information in this manual is subject to change without notice.

Your safety and the safety of others is very important.

We have provided many important safety messages in this manual and on your appliance. Always read and obey all safety messages.

This is a safety Alert symbol.
This symbol alerts you to potential hazards that can kill or hurt you and others.

All safety messages will follow the safety alert symbol with the word "WARNING" or "CAUTION". These words mean:

Indicates a hazard which, if not avoided, can result in severe personal injury or death and damage to product or other property.

Indicates a hazard which, if not avoided, can result in personal injury and damage to product or other property.

All safety messages will tell you what the potential hazard is, tell you how to reduce the chance of injury, and tell you what will happen if the instructions are not followed.

Indicates property damage can occur if instructions are not followed.

 **WARNING**



Refrigeration system under high pressure

Do not puncture, heat, expose to flame or incinerate.



Only certified refrigeration technicians should service this equipment.

R410A systems operate at higher pressures than R22 equipment. Appropriate safe service and handling practices must be used.

Only use gauge sets designed for use with R410A. Do not use standard R22 gauge sets.

INTRODUCTION

Personal Injury Or Death Hazards

	 WARNING	 AVERTISSEMENT	 ADVERTENCIA
SAFETY FIRST	Do not remove, disable or bypass this unit's safety devices. Doing so may cause fire, Doing so may cause fire, injuries, or death.	Ne pas supprimer, désactiver ou contourner cette l'unité des dispositifs de sécurité, faire vous risqueriez de provoquer le feu, les blessures ou la mort.	No eliminar, desactivar o pasar por alto los dispositivos de seguridad de la unidad. Si lo hace podría producirse fuego, lesiones o muerte.

 **WARNING**

ALWAYS USE INDUSTRY STANDARD
PERSONAL PROTECTIVE EQUIPMENT
(PPE)

ELECTRICAL HAZARDS:

- Unplug and/or disconnect all electrical power to the unit before performing inspections, maintenance, or service.
- Make sure to follow proper lockout/tag out procedures.
- Always work in the company of a qualified assistant if possible.
- Capacitors, even when disconnected from the electrical power source, retain an electrical charge potential capable of causing electric shock or electrocution.
- Handle, discharge, and test capacitors according to safe, established, standards, and approved procedures.
- Extreme care, proper judgment, and safety procedures must be exercised if it becomes necessary to test or troubleshoot equipment with the power on to the unit.
- Do not spray water on the air conditioning unit while the power is on.
- Electrical component malfunction caused by water could result in electric shock or other electrically unsafe conditions when the power is restored and the unit is turned on, even after the exterior is dry.
- Use air conditioner on a single dedicated circuit within the specified amperage rating.
- Use on a properly grounded outlet only.
- Do not cut or modify the power supply cord or remove the ground prong of the plug.
- Never operate the unit on an extension cord.
- Follow all safety precautions and use proper and adequate protective safety aids such as: gloves, goggles, clothing, properly insulated tools, and testing equipment etc.
- Failure to follow proper safety procedures and/or these warnings can result in serious injury or death.

INTRODUCTION

PERSONAL INJURY OR DEATH HAZARDS

- **REFRIGERATION SYSTEM REPAIR HAZARDS:**

- Use approved standard refrigerant recovering procedures and equipment to relieve high pressure before opening system for repair. Reference EPA regulations (40 CFR Part 82, Subpart F) Section 608.
- Do not allow liquid refrigerant to contact skin. Direct contact with liquid refrigerant can result in minor to moderate injury.
- Be extremely careful when using an oxy-acetylene torch. Direct contact with the torch's flame or hot surfaces can cause serious burns.
- Make certain to protect personal and surrounding property with fire proof materials and have a fire extinguisher at hand while using a torch.
- Provide adequate ventilation to vent off toxic fumes, and work with a qualified assistant whenever possible.
- Always use a pressure regulator when using dry nitrogen to test the sealed refrigeration system for leaks, flushing etc.

- **MECHANICAL HAZARDS:**

- Extreme care, proper judgment and all safety procedures must be followed when testing, troubleshooting, handling, or working around unit with moving and/or rotating parts.
- Be careful when, handling and working around exposed edges and corners of the sleeve, chassis, and other unit components especially the sharp fins of the indoor and outdoor coils.
- Use proper and adequate protective aids such as: gloves, clothing, safety glasses etc.
- Failure to follow proper safety procedures and/or these warnings can result in serious injury or death.

- **PROPERTY DAMAGE HAZARDS**

- **FIRE DAMAGE HAZARDS:**

- Read the Installation/Operation Manual for the air conditioning unit prior to operating.
- Use air conditioner on a single dedicated circuit within the specified amperage rating.
- Connect to a properly grounded outlet only.
- Do not remove ground prong of plug.
- Do not cut or modify the power supply cord.
- Do not use extension cords with the unit.
- Be extremely careful when using acetylene torch and protect surrounding property.
- Failure to follow these instructions can result in fire and minor to serious property damage.

- **WATER DAMAGE HAZARDS:**

- Improper installation, maintenance or servicing of the air conditioner unit can result in water damage to personal items or property.
- Insure that the unit has a sufficient pitch to the outside to allow water to drain from the unit.
- Do not drill holes in the bottom of the drain pan or the underside of the unit.
- Failure to follow these instructions can result in damage to the unit and/or minor to serious property damage.

INTRODUCTION

Kühl Control Options

The new Kühl gives you a variety of options for control, programming, and scheduling including wireless capabilities.

Wireless Programming and Control:

Friedrich Connect allows you to conveniently control, program, and monitor your air conditioning unit remotely from a smartphone or computer.

Pre-Programmed Timer Options:

Your unit's digital control comes equipped with a 24-hour timer.

24-Hour Timer

The 24-hour timer allows you to set 2 temperature changes at pre-set times on the unit control panel.

Customizable Programming Options:

Customizable timers, with up to four temperature adjustments per day, can be set using Friedrich Connect for one or multiple units.

See www.friedrich.com for complete details on Friedrich Connect.



Figure 101 (New Kühl Options)

INTRODUCTION

This service manual is designed to be used in conjunction with the installation and operation manuals provided with each air conditioning system.

This service manual was written to assist the professional service technician to quickly and accurately diagnose and repair malfunctions.

Due to continuing research in new energy-saving technology, all information in this manual is subject to change without notice.

Installation procedures are not given in this manual. They are given in the Installation/Operation manual which can be acquired on the Friedrich [website](#).

Component Identification

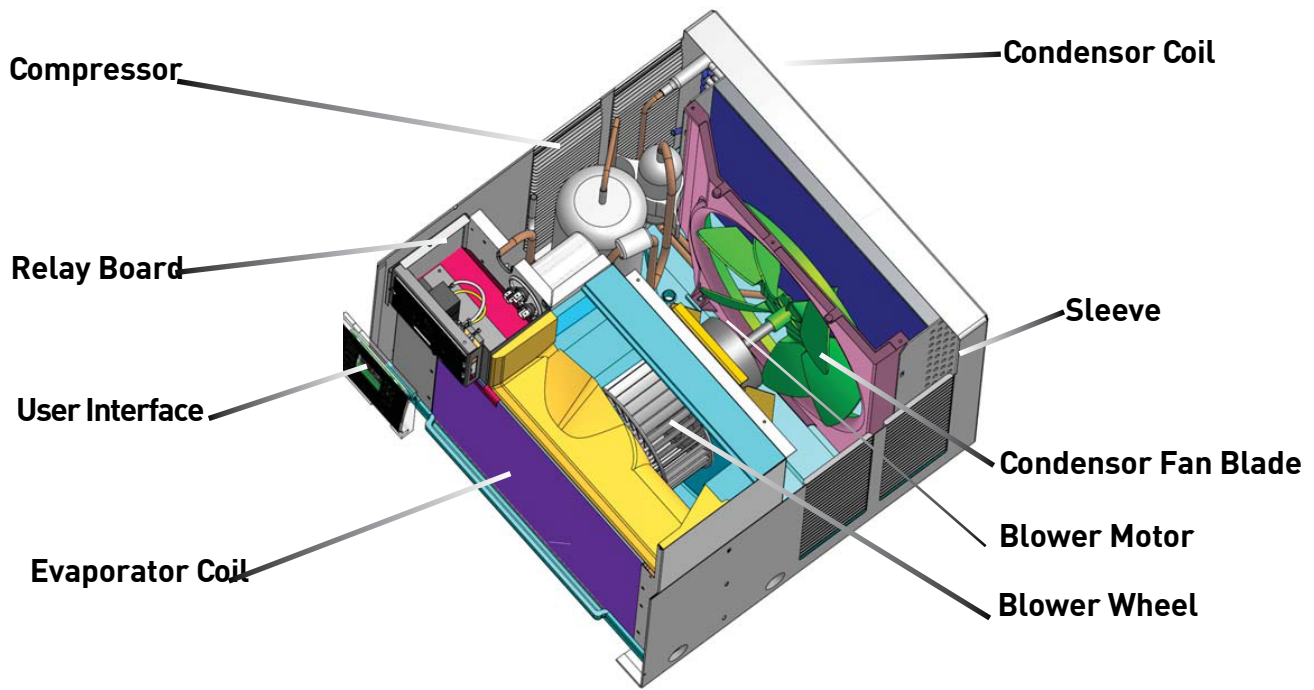

Figure 102 (Component Identification)

Model and Serial Number Location

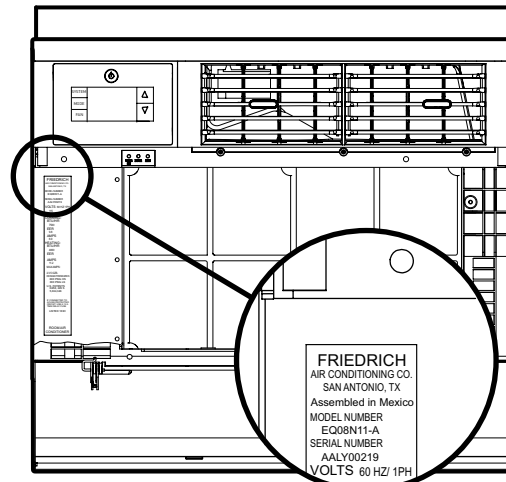
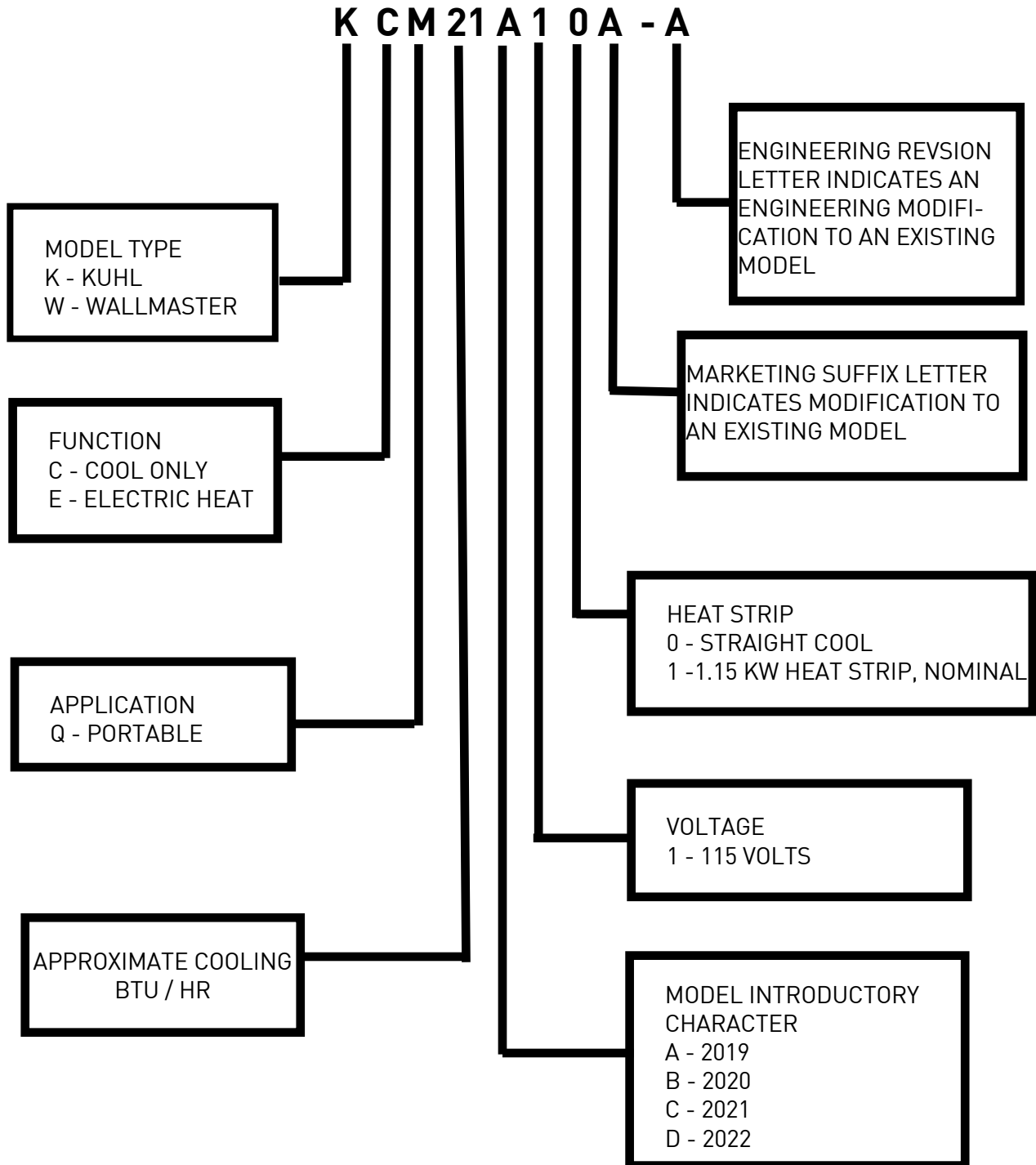

Figure 103 (Model and Serial Number Location)

INTRODUCTION

Model Number Reference Guide



IMPORTANT: It will be necessary for you to accurately identify the unit you are servicing, so you can be certain of a proper diagnosis and repair.

Figure 104 (Model Number Reference Guide)

INTRODUCTION

Serial Number Reference Guide

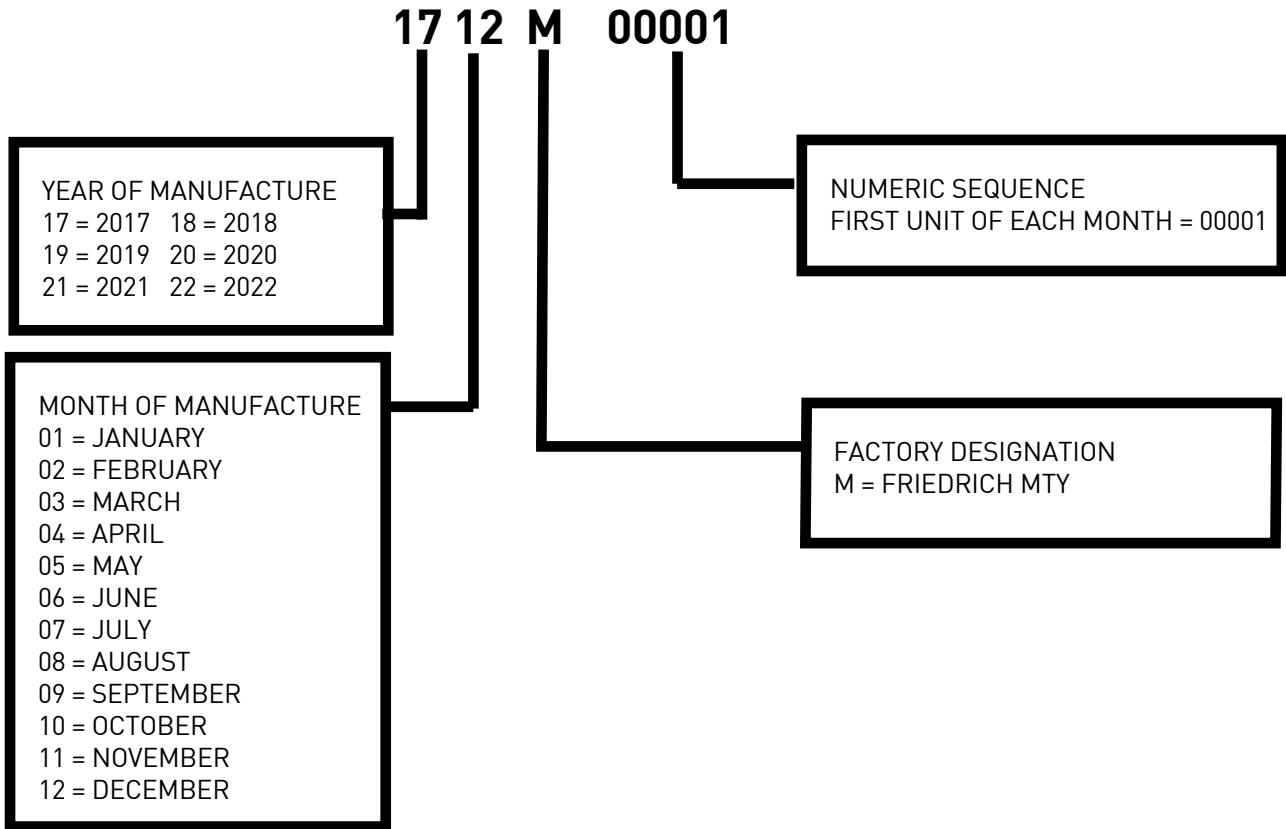

Figure 105 (Serial Number Reference Guide)

SPECIFICATIONS

Refrigeration Systems Performance Data

Model	Conden- sor Temp Deg. F	Discharge Temp Deg F	Suction Temp Deg F	Electrical Ratings				Voltage	Breaker Size
				AMPS COOL	AMPS HEAT	LOCKED ROTOR AMPS	CHARGE IN OZ		
Kühl® [Cool Only]									
KCQ06A10A	119	148	55	4.8		25.2	18.8	115	15
KCQ08A10A	116	150	56	6.5		30.5	15.2	115	15
KCQ08A10A-A KCQ08A10A-B KCQ08A10A-C KCQ08A10A-E KCQ08A10A-F	116	150	56	6.5		30.5	15.2	115	15
KCQ08A10A-D	116	150	56	6.5		30.5	16.7	115	15
KCQ08A10A-G	116	150	56	6.5		30.5	16.7	115	15
KCQ10A10A KCQ10A10B	119	161	52	8.6		49	19.4	115	15
Kühl® + (Electric Heat)									
KEQ0811A	114	145	48	6.4	11.2	30.5	15.6	115	15

*Rating Conditions: 80 degrees F, room air temp. & 50% relative humidity, with 95 degree F, outside air temp & 40% relative humidity, all systems use R-410A. Test done at highest unit fan speed.

Figure 201 (Refrigeration Systems Performance Data)

Model	UPC	Cooling Btu	Heating Btu	Volts	Cooling Amps	Cooling Watts	Heating Amps	Heating Watts	EER	CEER	Moisture Removal- Pints/HR CFM Sleeve		
Kühl® [Cool Only]													
★ KCQ06A10A	724587436570	6000	—	115	4.8	492	—	—	12.2	12.1	1.5	190	Q
★ KCQ08A10A	724587436587	8000	—	115	6.5	661	—	—	12.1	12.0	2.1	200	
KCQ10A10A	724587436594	9500	—	115	8.6	864	—	—	11.0	10.9	3.2	250	
KCQ10A10B		9700	—	115	8.6	864	—	—	11.0	10.9	3.2	250	
Kühl® + (Electric Heat)													
KEQ08A11A	724587432749	7700	4000	115	6.4	694	11.2	1290	11.1	11.0	2.1	200	Q

Figure 202 (Specifications)

SPECIFICATIONS

Installation

Sleeve	Height Inches	Width Inches	Depth with Front Inches A	Shell Depth to Louvers Inches B	Minimum Extension Into Room*	Minimum Extension Outside * Inches	Window Width INCHES		In-wall Installation Finished Hole Inches			Carton Dimensions Inches		
							Minimum**	Maximum	Height	Width	Max. Depth C	Height	Width	Depth
Q	14 1/4"	19 3/4"	21 3/8"	8 1/2"	5 1/2"	10 3/4"	22"	42"	14 1/2"	20"	8 1/2"	18 3/4"	22"	25 1/2"

Figure 203 (Installation Specifications)

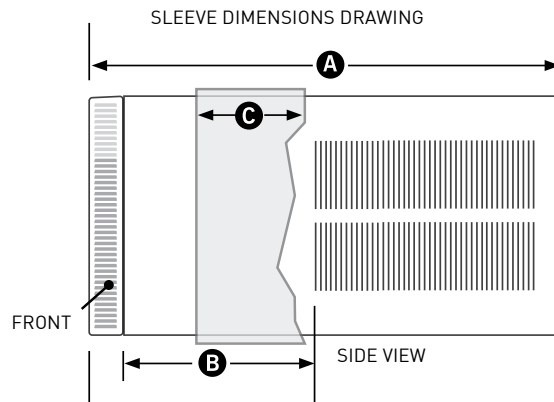

Figure 204 (Sleeve Dimensions)

Installation Clearances

Improper installation of the Air Conditioner can cause poor performance and premature wear of the unit. Ensure that the KUHL unit is installed with proper clearances as described below. Ensure no obstructions, or enclosures are within clearances limits to allow for proper airflow.

Clearances

- Top and Bottom of Unit - One (1) foot
- Sides of Unit - One (1) foot
- Front of Unit - Three (3) feet
- Rear of Unit - Three (3) feet

SPECIFICATIONS

Electrical Data

WARNING	
	<p>ELECTRIC SHOCK HAZARD</p> <p>Turn off electric power before service or installation.</p> <p>All electrical connections and wiring MUST be installed by a qualified electrician and conform to the National Electrical Code and all local codes which have jurisdiction.</p> <p>Failure to do so can result in personal injury or death.</p>

NOTICE
<p>FIRE HAZARD</p> <p>Not following the above WARNING could result in fire or electrically unsafe conditions which could cause moderate or serious property damage.</p> <p>Read, understand and follow the above warning.</p>

Circuit Rating/Breaker/power cord/wall Receptacle

Model	Circuit Rating Breaker or T-D Fuse	Plug Face (NEMA#)	Power Cord Length (ft.)	Required Wall Receptacle NEMA NO.	Wall Outlet Appearance
KCQ06A10A, KCQ08A10A, KCQ10A10A, KCQ10A10B, KEQ08A11A	125V - 15A	5 - 15P	6	5-15R	

Figure 205 (Circuit Breaker / Plug / Receptacle / Cord Rating)

Wire Size - Use ONLY wiring size recommended by the National Electric Code (NEC) for single outlet branch circuit.

Fuse/ Circuit Breaker - Use ONLY the correct HACR type and size fuse/circuit breaker. Read electrical ratings on unit's rating plate. Proper circuit protection is the responsibility of the homeowner.

Grounding - Unit **MUST** be grounded from branch circuit through service cord to unit, or through separate ground wire provided on permanently connected units. Be sure that branch circuit or general purpose outlet is grounded.

Receptacle - The field supplied outlet must match plug on service cord and be within reach of service cord. Do NOT alter the service cord or plug. Do NOT use an extension cord. Refer to the table above for proper receptacle and fuse type.

SPECIFICATIONS

Electrical Data

⚠ WARNING	
	Electrical Shock Hazard Make sure your electrical receptacle has the same configuration as your air conditioner's plug. If different, consult a Licensed Electrician. Do not use plug adapters. Do not use an extension cord. Do not remove ground prong. Always plug into a grounded 3 prong outlet. Failure to follow these instructions can result in death, fire, or electrical shock.

NOTICE
Do not use the LCDI device as an ON/OFF switch. Failure to adhere to this precaution may cause premature equipment malfunction.

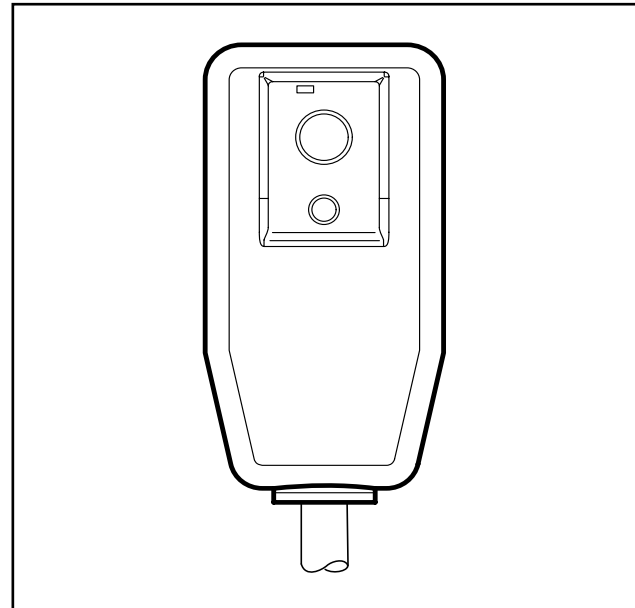

Figure 206 (LCDI Power Cord)

Make sure the wiring is adequate for your unit.

If you have fuses, they should be of the time delay type. Before you install or relocate this unit, be sure that the amperage rating of the circuit breaker or time delay fuse does not exceed the amp rating listed in Table 205.

DO NOT use an extension cord.

The cord provided will carry the proper amount of electrical power to the unit; an extension cord may not.

Make sure that the receptacle is compatible with the air conditioner cord plug provided.

Proper grounding must be maintained at all times. Two prong receptacles must be replaced with a grounded receptacle by a certified electrician.

The grounded receptacle should meet all national and local codes and ordinances. You must use the three prong plug furnished with the air conditioner. Under no circumstances should you remove the ground prong from the plug.

Test the power cord.

All Friedrich room air conditioners are shipped from the factory with a Leakage Current Detection Interrupter (LCDI) equipped power cord. The LCDI device on the end of the cord meets the UL and NEC requirements for cord connected air conditioners.

To test your power supply cord:

1. Plug power supply cord into a grounded 3 prong outlet.
2. Press RESET (see Figure 206).
3. Press TEST, listen for click; the RESET button trips and pops out.
4. Press and release RESET (Listen for click; RESET button latches and remains in). The power cord is ready for use.

Once plugged in, the unit will operate normally without the need to reset the LCDI device. If the LCDI device fails to trip when tested or if the power supply cord is damaged, it must be replaced with a new power supply cord from the manufacturer.

OPERATION

Airflow Direction

The airflow path may be adjusted to distribute air independently from the left or right side of the discharge opening. Each of the banks of louvers can be directed left, right, up, or down in order to achieve the most optimum airflow positioning.

To adjust airflow direction, grab the lever in the center of the louver bank and move it in the direction that you would like the air to be directed. Please note that it is normal that airflow may be stronger out of one side of the louvers than the other.

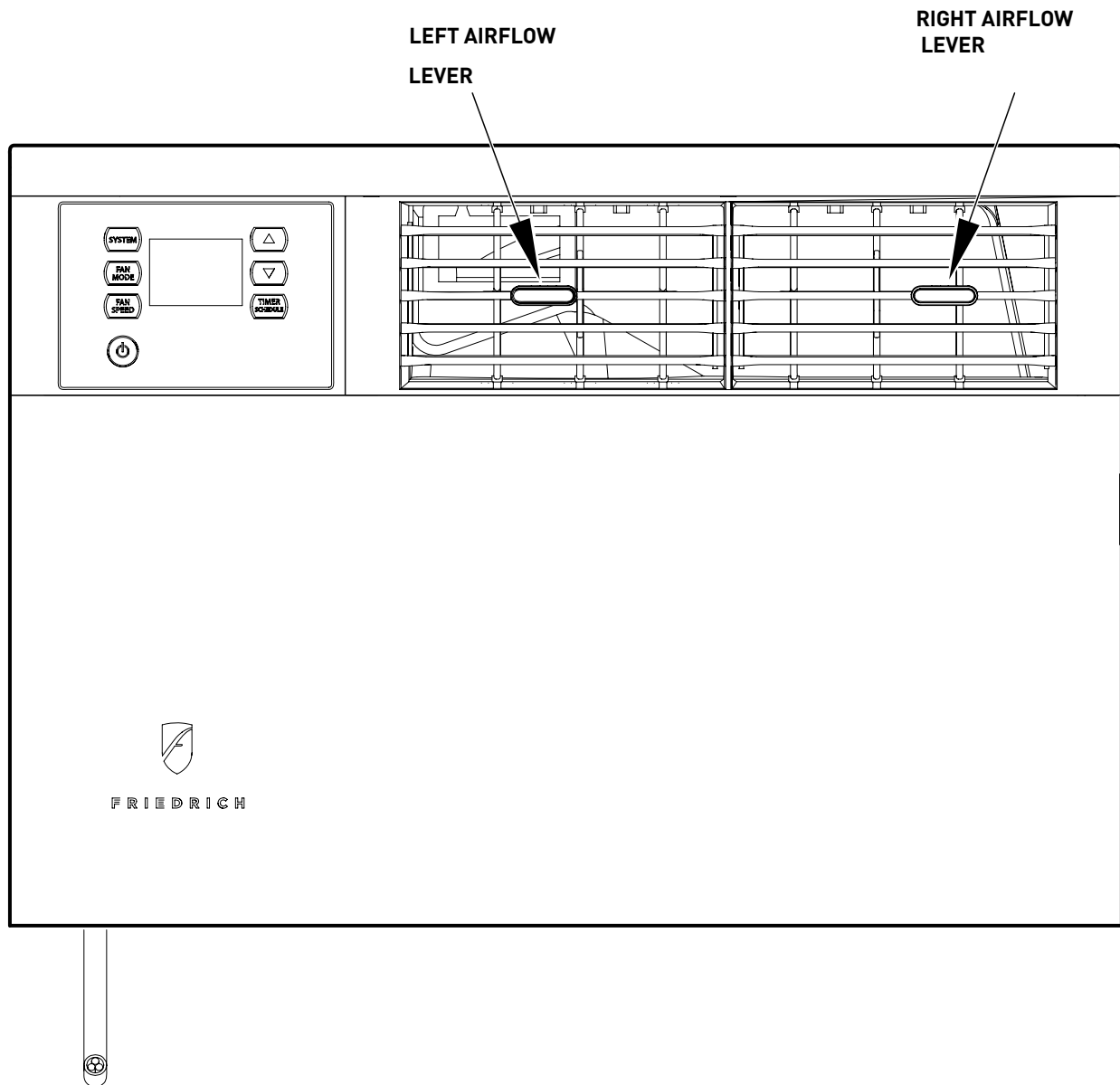

FIGURE 301 (AIRFLOW ADJUSTMENT)

OPERATION

User Interface

All of the control panel function buttons and mode icons can be viewed in Figure 302.

Power On – Press the button to turn on the air conditioner. The power button illuminates to indicate that the power is on. The backlight on the power switch will automatically turn off after 20 seconds of inactivity. The remote control can also be used to turn power ON / OFF (see Remote Control).

Display – The display is a high efficiency LCD with a built-in backlight. After 20 seconds of inactivity, the display switches off. Touching any button automatically changes the display to full brightness.

There are three control push buttons on each side of the display.

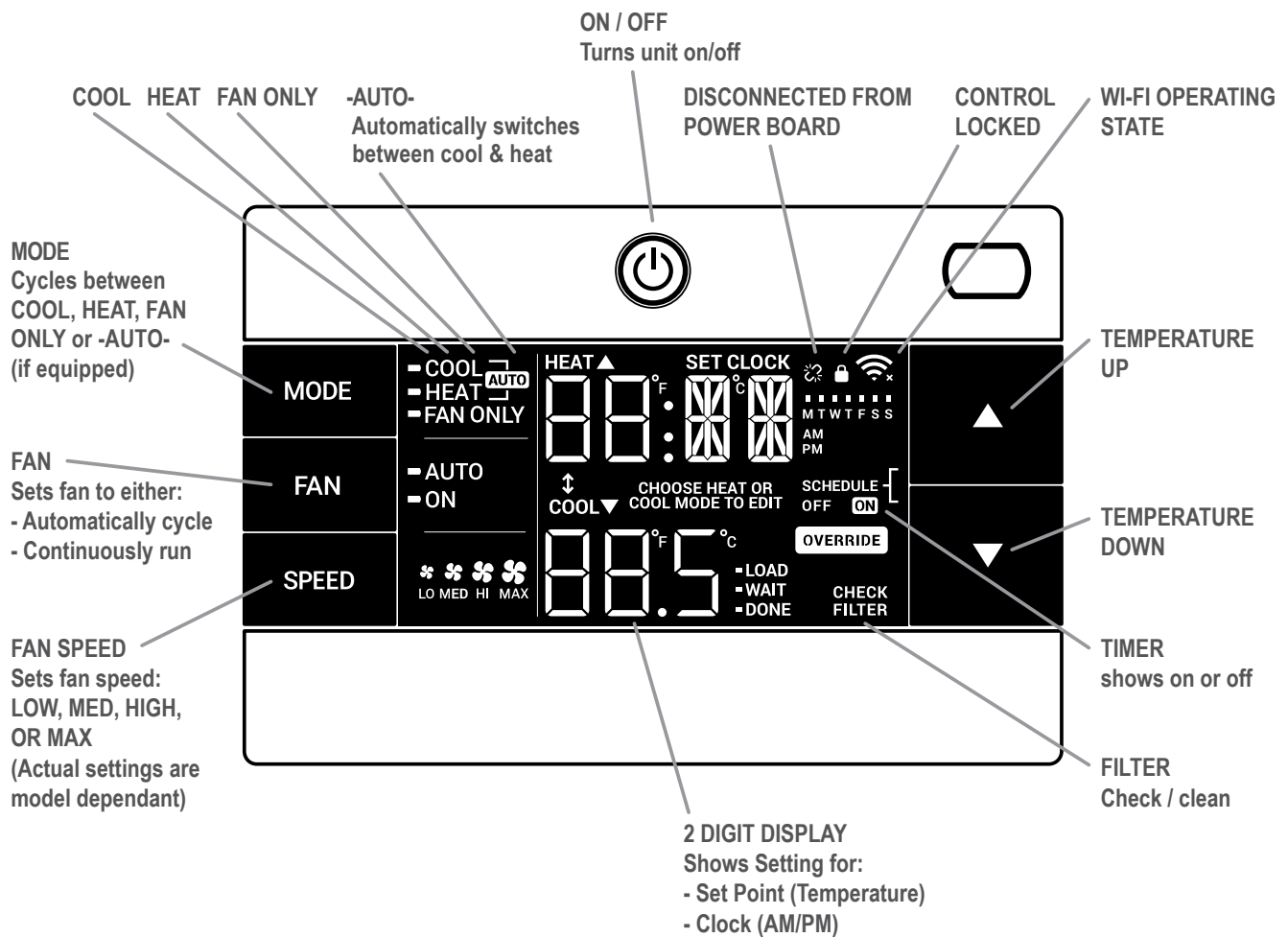

Figure 302 (Control Panel and Display)

OPERATION

User Interface

Accessing Sub-Menus

The MENU button accesses the sub-menu. See figure 304.

The arrow buttons navigate the 6 menu options (See Figure 305):

- LIM
- LOCK
- TM
- CnCT
- F-C
- diAG

The return button exits the menu. See Figure 306.

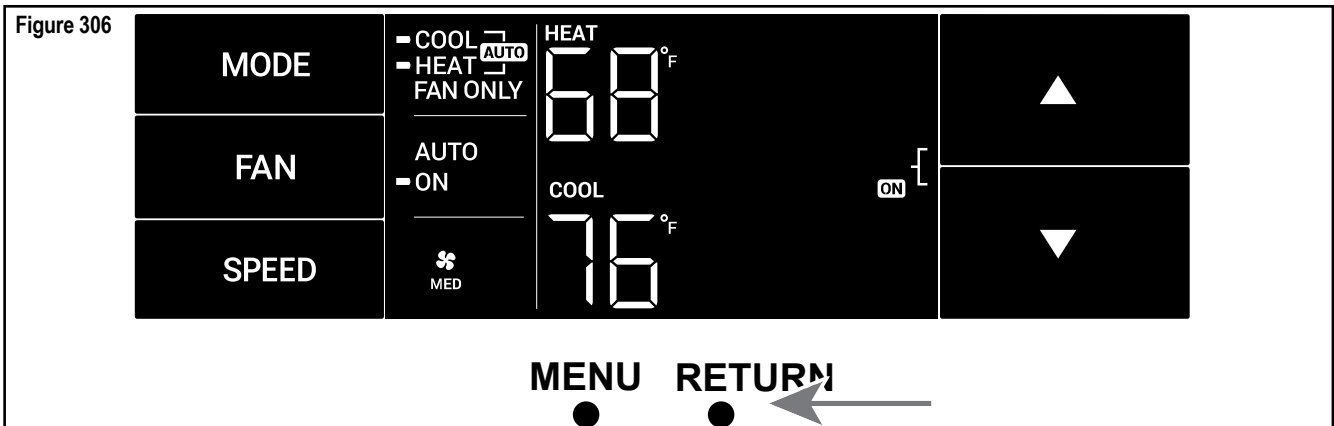
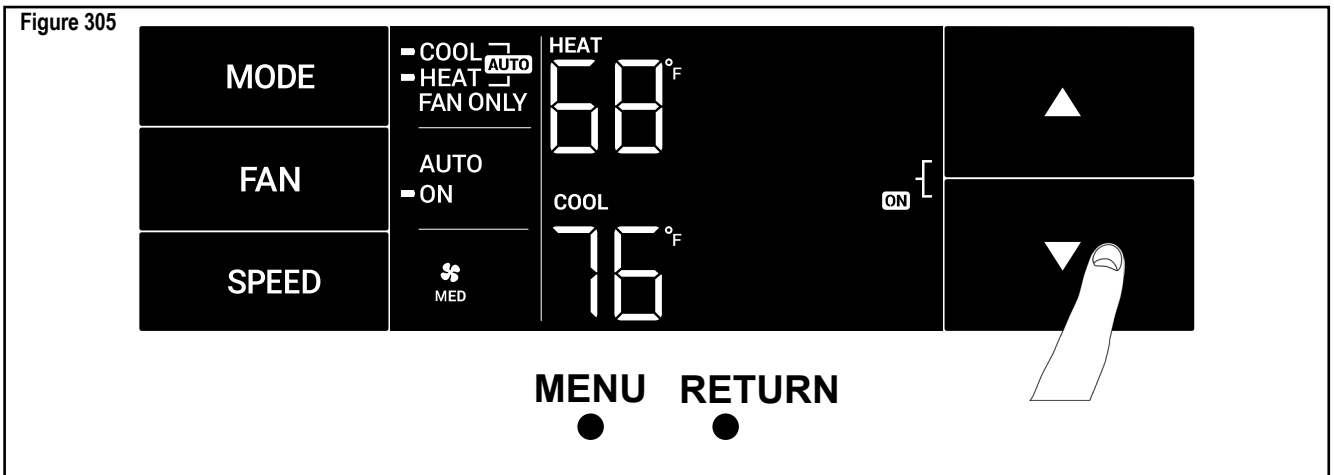
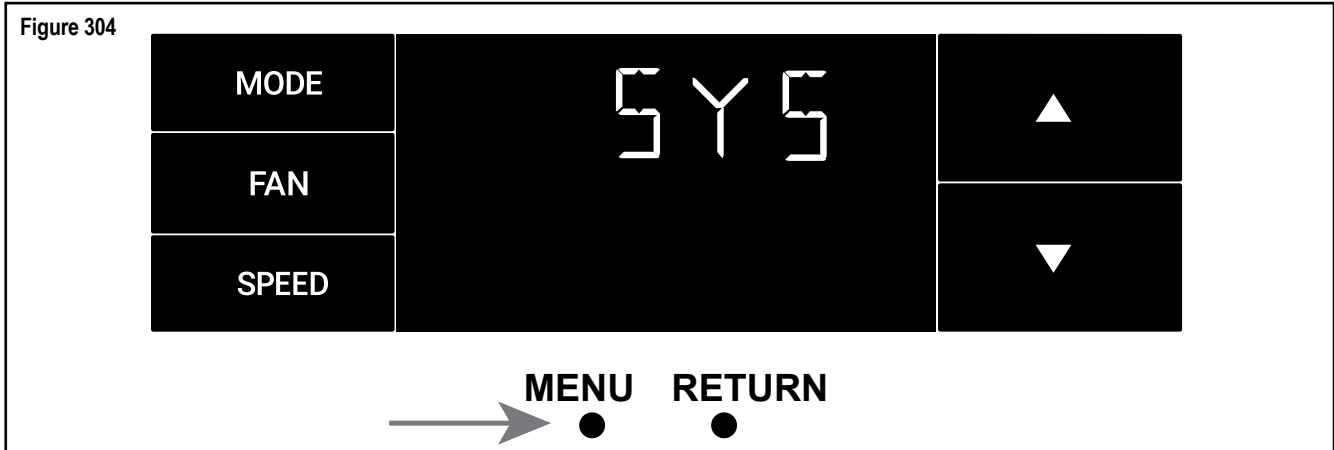

OPERATION

User Interface

Navigating Inside the Sub-Menus

The MENU button moves you forward through the sub-menu. See Figure 307.

The return button moves you backward once inside the LIM and TM menus. See Figure 308.

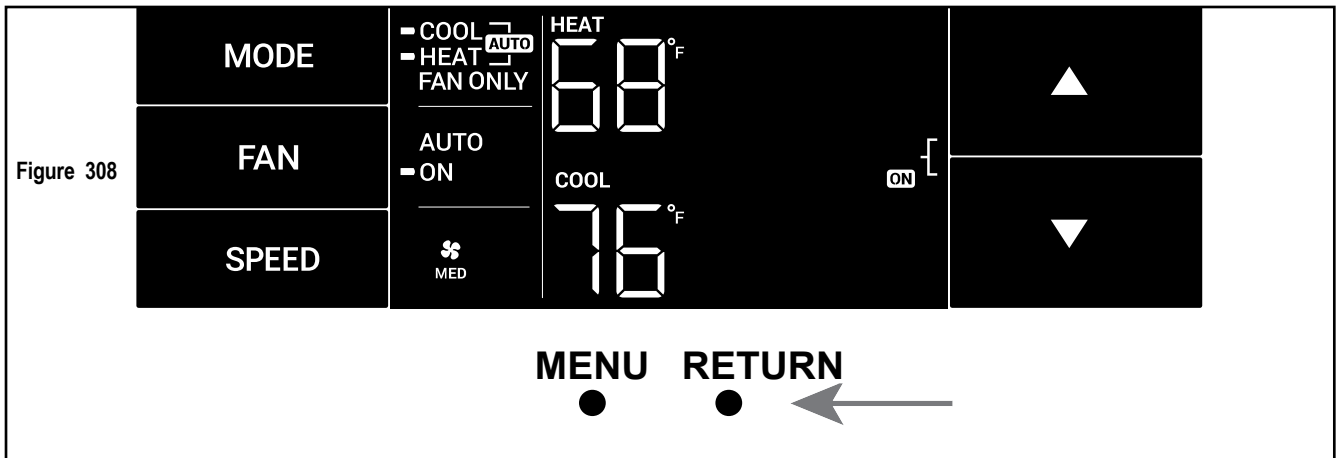
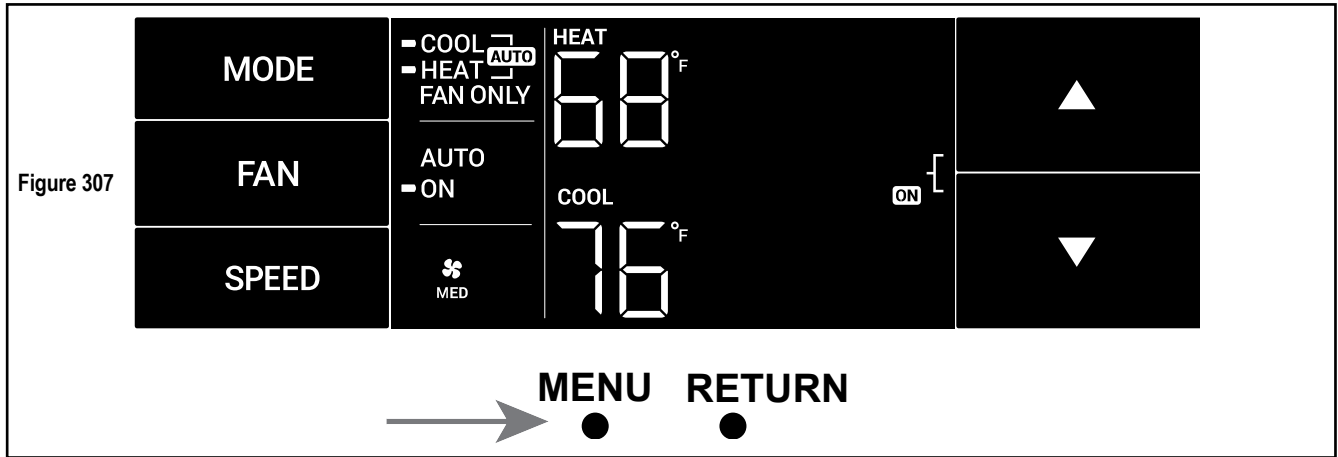

OPERATION

User Interface

The LIM Menu (Limit)

This is the limit menu. See Figure 309.

Upon entering the menu, the first option will be to set the lower set-point limit using the arrow buttons. See Figure 310.

Then you can set the higher set-point limit using the arrow buttons. See Figure 311.

Pressing the menu button completes the limit setting. See Figure 312.

Figure 309

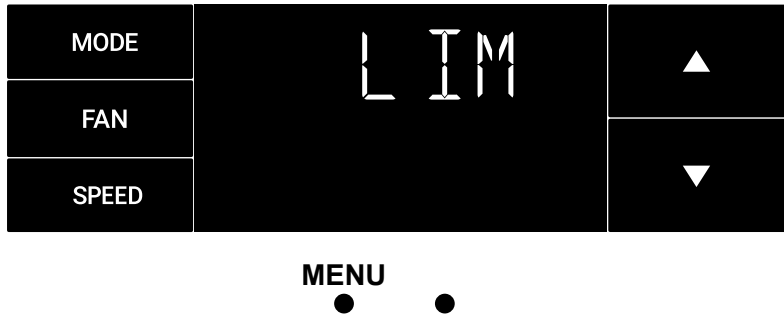

Figure 310

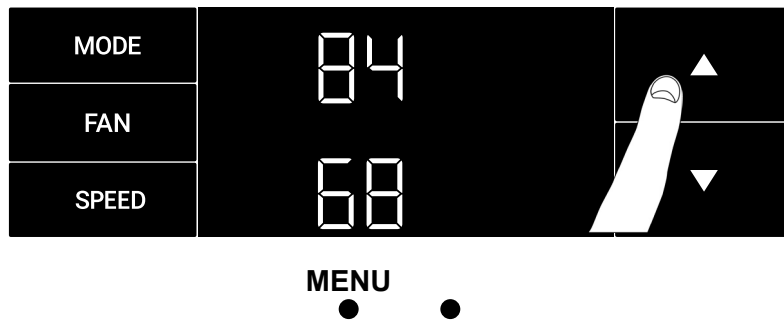

Figure 311

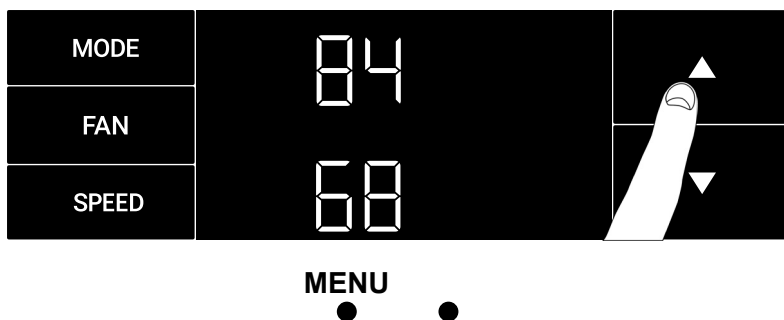
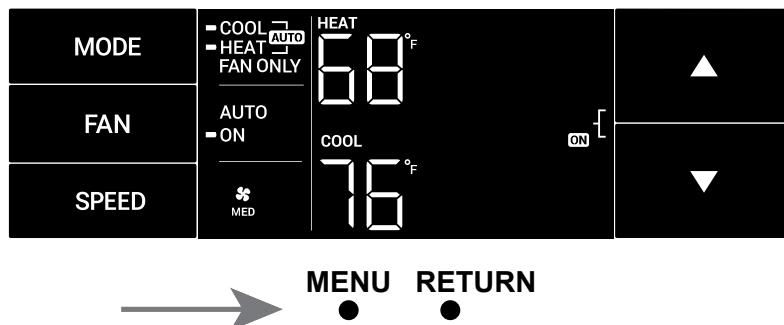

Figure 312



OPERATION

User Interface

The TM Menu (Timer)

This is the TM menu used to set a timer. See Figure 313.

In the menu, you set the current time using the arrow buttons. See Figure 314. (Note: These two “set clock” steps will be skipped if the unit is already connected to Wi-Fi.)

First, set the hour.

Using the MENU button, you switch to the minutes and complete setting the time. See Figure 315.

You select your mode. Either cool, heat, or auto. Toggle these using the mode button. See Figure 316. (Note: cooling-only models skip this step.)

The process is the same for all three modes. Auto mode will be shown as the example.

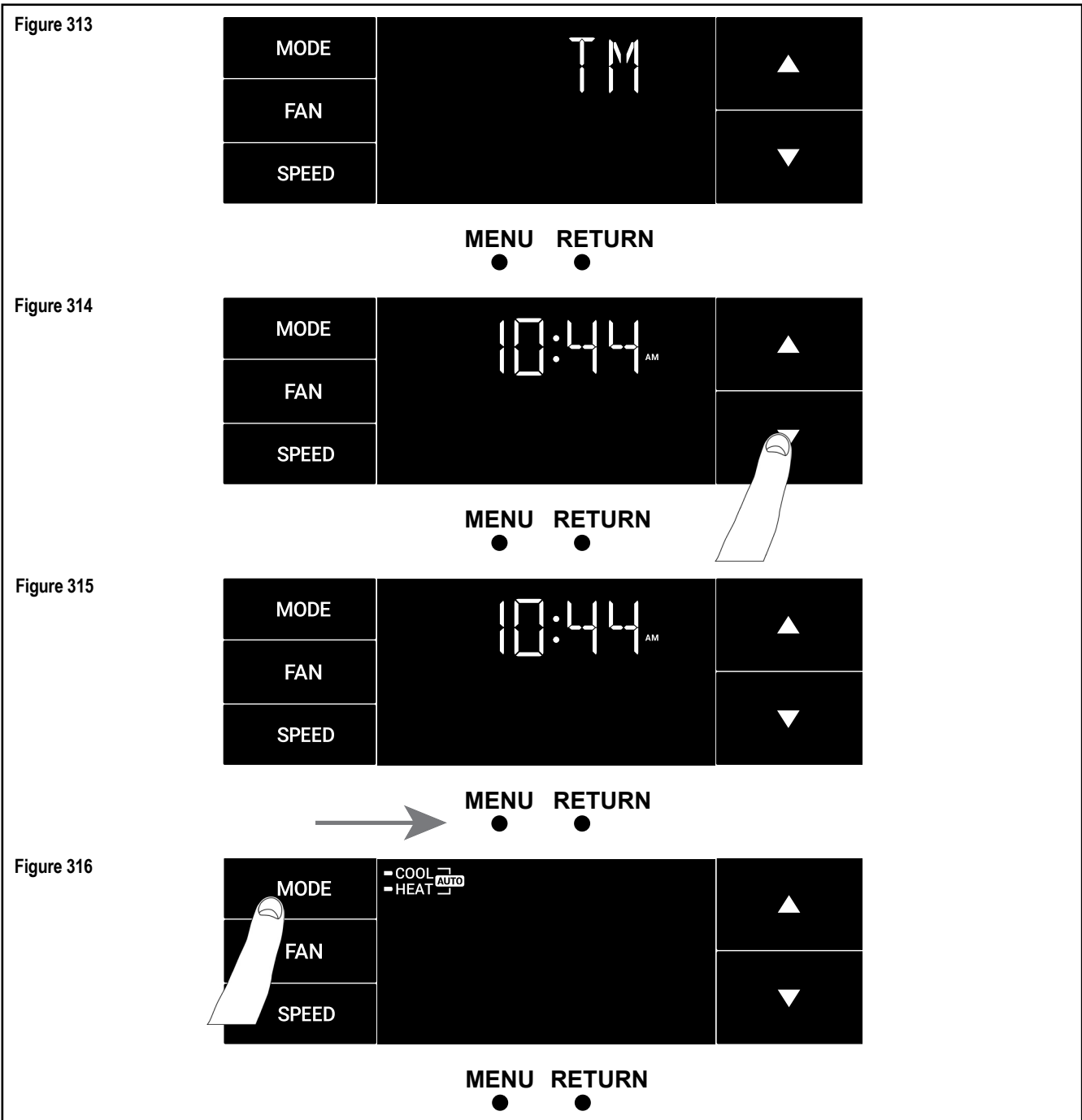

OPERATION

User Interface

The TM Menu (Timer) continued

Auto mode selected. See Figure 317.

Set the cool set-point for your first timer period using the arrow buttons. The cooling mode timer only sets the cool set-point. See Figure 318.

Next, set the heat set-point for your first timer period. The heating mode timer only sets the heat set-point. See Figure 319.

Note: The auto mode timer sets both the cool and heat set-point.

Set the time to start the first timer period. See Figure 320.

Figure 317

MODE	- COOL - - HEAT -	AUTO	▲
FAN			
SPEED			▼

MENU RETURN

Figure 318

MODE	HEAT	68	▲
FAN	COOL	76	▲
SPEED			▼

MENU RETURN

Figure 319

MODE	HEAT	68	▲
FAN	COOL	76	▲
SPEED			▼

MENU RETURN

Figure 320

MODE	08:00	AM	▲
FAN			
SPEED			▼

MENU RETURN

OPERATION

User Interface The TM Menu (Timer) continued

Set the cool set-point for the second scheduled timer. See Figure 321.

Set the heat set-point for the second timer.

Set the time to start the second timer period. See Figure 322.

Press the MENU button to complete the time timer setup.
See Figure 323.

Figure 321

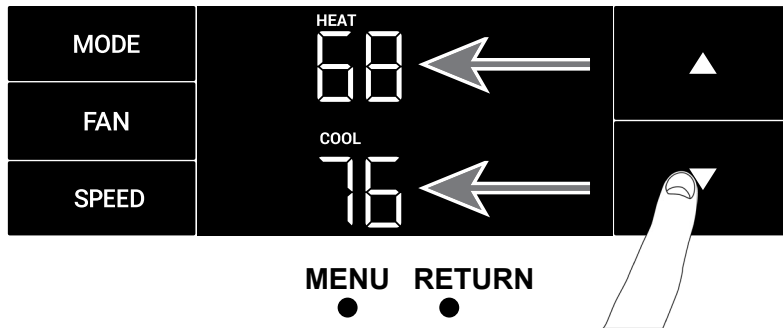
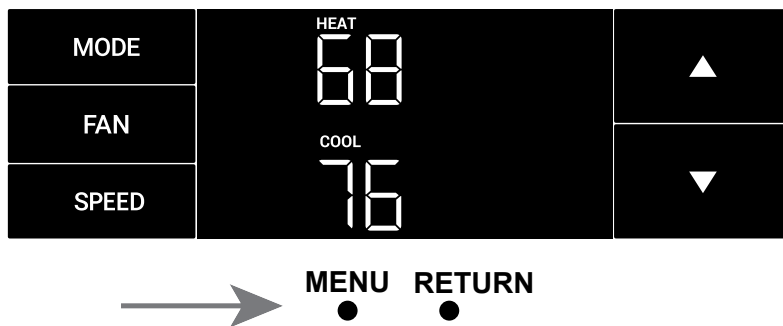

Figure 322



Figure 323



OPERATION

User Interface

The F-C Menu (Fahrenheit/Celsius)

This menu is used to toggle between Fahrenheit and Celsius. See Figure 324.

Using the arrow buttons on the right side switches it from Fahrenheit to Celsius. See Figures 325 and 326.

Figure 324

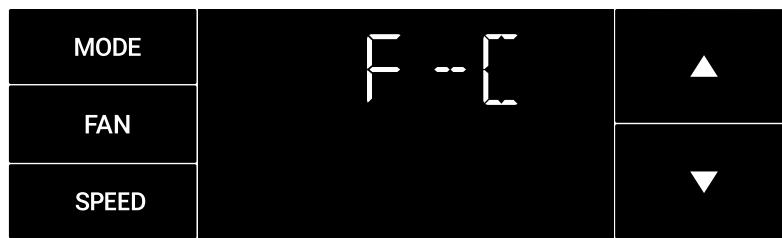

Figure 325

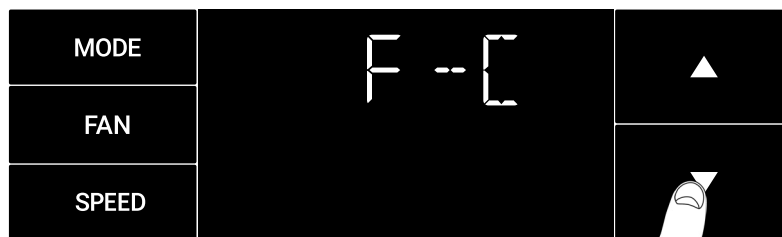

Figure 326



OPERATION

User Interface

The Lock Menu

This menu is used to lock the settings with a four(4) digit passcode.

This is the Lock Menu. See Figure 327.

The menu lock is defaulted to off. Use the arrows to toggle between off and on. See Figure 328.

This is LOCK on. See Figure 329.

Set the first digit of the password using the arrow buttons. Use the menu button to proceed to the next digit. See Figure 330

Repeat the previous step for the remaining three(3) digits.

Press the menu button to complete the lock setting process.

NOTICE

Be sure to write down your passcode if you activate this feature. Please contact technical support if you have lost your lock code.
1-800-541-6645

Figure 327

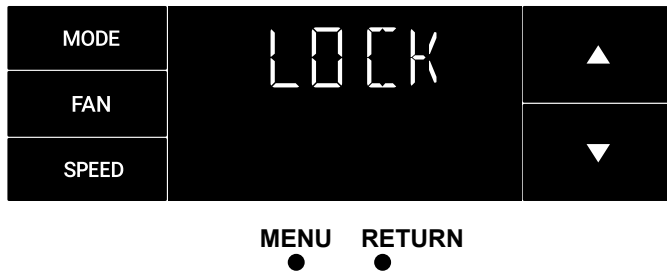

Figure 328



Figure 329



Figure 330

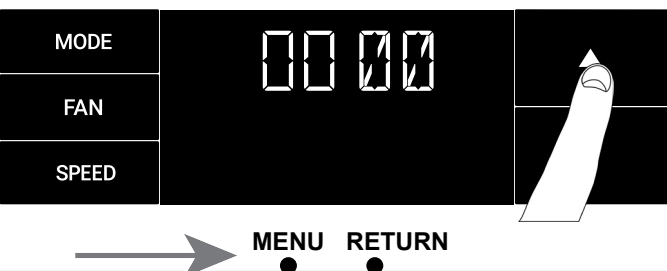

OPERATION

User Interface

The Lock Menu continued

The ON on the right side of the display shows the lock function is active. To go back into the menu, select the menu button again. See Figure 331.

Enter the password in the same manner it was created. See Figure 332.

Entering the correct password will give the user access to all of the sub-menus. See Figure 333.

Accessing the lock menu will allow you to toggle lock OFF if needed. See Figure 334

Figure 331

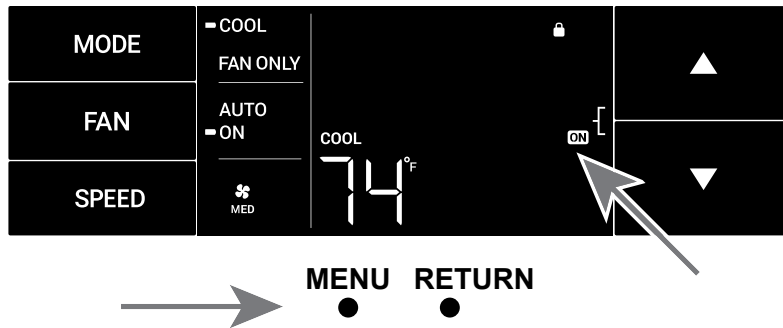

Figure 332



Figure 333



Figure 334



OPERATION

User Interface

The CnCT (WiFi Connection) Menu

This menu is used to turn on Wi-Fi connection.
This is the CnCT menu. Pressing the menu button will activate Wi-Fi. See Figure 335.
To setup WiFi, refer to Wi-Fi setup instructions.
The Wi-Fi symbol in the top right corner of the display shows Wi-Fi connection is on. See Figure 336.

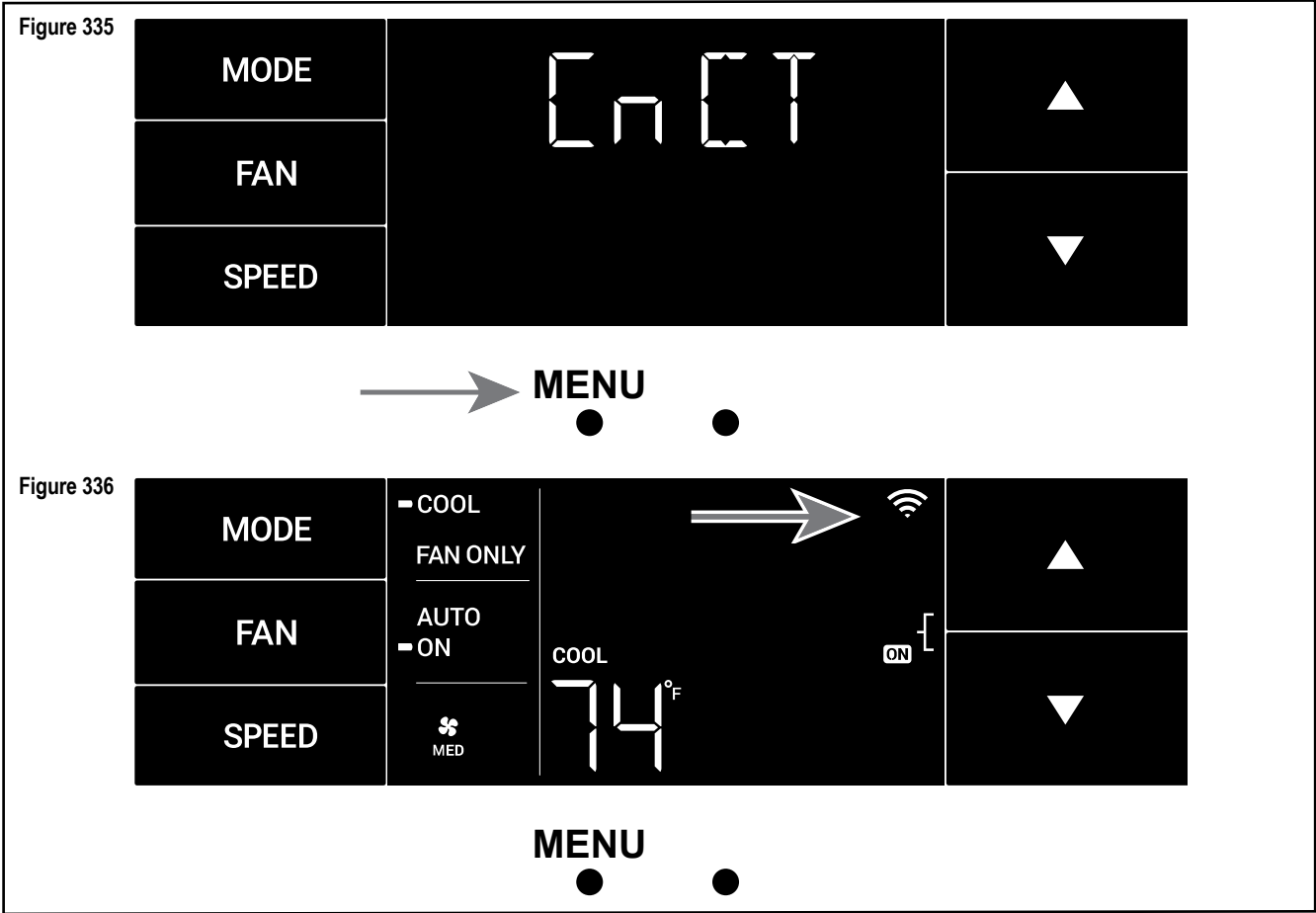

OPERATION

User Interface The diAG Menu

This menu is used to access the diagnostic codes. See Figure 337.

Selecting this sub-menu shows the E that represents "Error." See Figure 338.

Toggle through the error codes using the arrow keys. See Figure 339.

Figure 337



Figure 338



Figure 339



OPERATION

Control Panel

SYSTEM - The MODE button allows you to sequentially select up to four modes of operation:

- AUTO Available on select models
- COOL
- HEAT Available on select models
- FAN ONLY

AUTO FAN (No Cooling Demand)

When in AUTO mode, the fan only operates when the system has a demand to cool or heat the room.

In the ON fan mode, the fan operates all the time. The system periodically cools or heats the fan's airflow but the flow of air does not stop.

UP and DOWN Arrows - Pressing either an UP or DOWN button changes the system's setpoint (desired room temperature). These buttons are also used to make system parameter changes later in this manual.

One press equals 1 degree of change in Fahrenheit mode. One press equals 0.5 degree change in Celsius mode.

TIMER

The timer can be engaged or disengaged from the control panel. This is done by pressing or holding the UP and DOWN arrows simultaneously for three seconds.

OTHER FUNCTIONS

°F–°C Select

To switch from degrees Fahrenheit (F) to Celsius (C), press the MENU button and enter the F-C sub-menu.

FAN SPEED - The FAN SPEED button allows you to toggle between three modes of operation: LOW, MEDIUM, and HIGH .

Alerts

When the filter needs to be cleaned or replaced, the CHECK FILTER icon displays. Refer to Routine Maintenance for filter maintenance requirements.

The alert can be dismissed by pressing the FAN and SPEED buttons for 3 seconds.

Lock Control Panel

To lock/unlock the front panel controls, navigate to the "LOCK" sub-menu found after clicking the MENU button. The lock requires a four digit pass code to lock/unlock the unit. This pass code will be required to enter the menu to unlock the unit. The LOCK icon illuminates to indicate the locked status.

The LOCK icon disappears to indicate unlocked status.



External Control Status

The Wi-Fi icon illuminates to indicate that the system is receiving a Wi-Fi connection. The Wi-Fi icon also provides information about the signal strength.



Advanced Functions

The functions mentioned in the following section may or may not be available depending on the air conditioner model.

Modify the TIMER Function

Navigate to the TIME menu to set the timer.

OPERATION

Remote Control

Remote Control - Refer to Figure 340A during operation description.

Getting Started - Install two (2) AAA batteries in the battery compartment located on the back of the unit.

Operation - The remote control should be within 25 feet of the air conditioner for operation (refer to Figure 340B for effectiveness). Press the power button to turn the remote on. The remote will automatically power off after 15 seconds if the buttons are not being pressed. The remote must be on to control the unit.

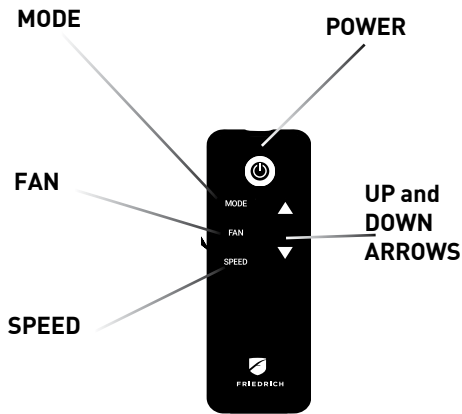

POWER Button - Turns remote and unit on and off.

MODE Button - Allows the user to sequentially select the following: AUTO, COOL, HEAT, and FAN ONLY operations. When the button is pressed, the display indicates which mode has been selected via a display message. Note that when the heating function is not available, the system will automatically skip the HEAT mode.

FAN Button - Selects between automatic (AUTO FAN) or CONTINUOUS operation. In the AUTO FAN mode, the fan only turns on and off when the compressor operates or the heat function is enabled.

NOTE: AUTO FAN is not available in the FAN ONLY Mode, the display indicates CONTINUOUS. In the CONTINUOUS mode, fan speed is determined by your selection on the FAN SPEED button.

SPEED Button - Used to sequentially select new fan speed, plus AUTO operation. When the FAN SPEED button is pressed, the fan speed icon (triangle) changes to indicate the new speed level. Fan speed automatically varies depending on the set temperature on the control panel and the actual room temperature. For example, if there is a big difference between your set temperature and the actual room temperature, the system fan speed increases to HIGH. It remains at this speed until the room temperature matches the set temperature.

UP and DOWN Arrows - Pressing either the UP or DOWN button changes the desired room temperature. The factory preset lower and upper limits are 60°F (16°C) and 99°F (37°C). These buttons are also used to navigate between function options when using the User Menu or Maintenance Mode.

Figure 340A (Remote Control)

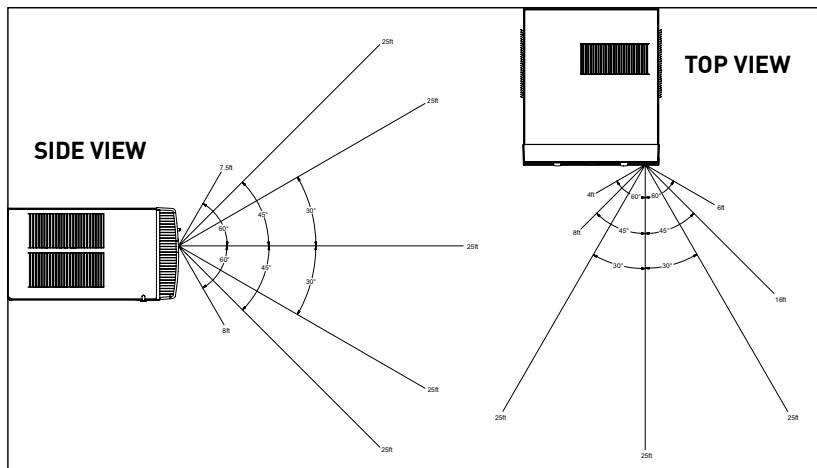

Remote Effectiveness

Handheld Remote - Has an operating range of up to 25 ft. The infrared remote control signal must have a clear path to transmit the command to the air conditioning unit. The remote signal has some ability to "bounce" off of walls and furniture similar to a television remote control. The diagram below shows the typical operating range of the control in a standard room with 8 ft high ceilings.

FIGURE 340B (REMOTE CONTROL)

OPERATION

Unit Cooling

Your air conditioner is designed to cool in warm weather when the outside temperature is above 60°F (15.6°C) and below 115°F (46.1°C), so it won't cool a room if it is already cool outside.

Condensation is normal

Air conditioners actually pump the heat and humidity from your room to the outside. Humidity becomes water, and your air conditioner will use most of the water to keep the outside coil cool. If there is excessive humidity, there may be excess water that will drip outside. This is normal operation.

Frosting

This usually occurs because of insufficient airflow across the coils, a dirty filter, cool damp weather, or all these. Set the SYSTEM mode to FAN ONLY and the frost will disappear. Setting the thermostat a little warmer will probably prevent the frosting from recurring.

Noises

Friedrich units are designed to operate as quietly as possible. An air conditioner mounted in a wall is quieter than one mounted in a window. It is important to ensure that the chassis seal gasket is properly installed (refer to SPECIFICATIONS FIGURE 205).

Unit Cooling Mode

Once the indoor ambient temperature rises past the cool demand threshold (Cool Set Point + 1.5 °F) (see figure below), and the compressor is not locked out, the cooling cycle begins. As shown in the figure below, the fan is started 5 seconds prior to the compressor. Once the indoor ambient temperature has been lowered to the cool set point (Cool Set Point minus .25 °F), the cooling cycle starts to terminate by shutting off the compressor. After a 30 seconds delay, the fan is shut off. (See figure below for graphic details)

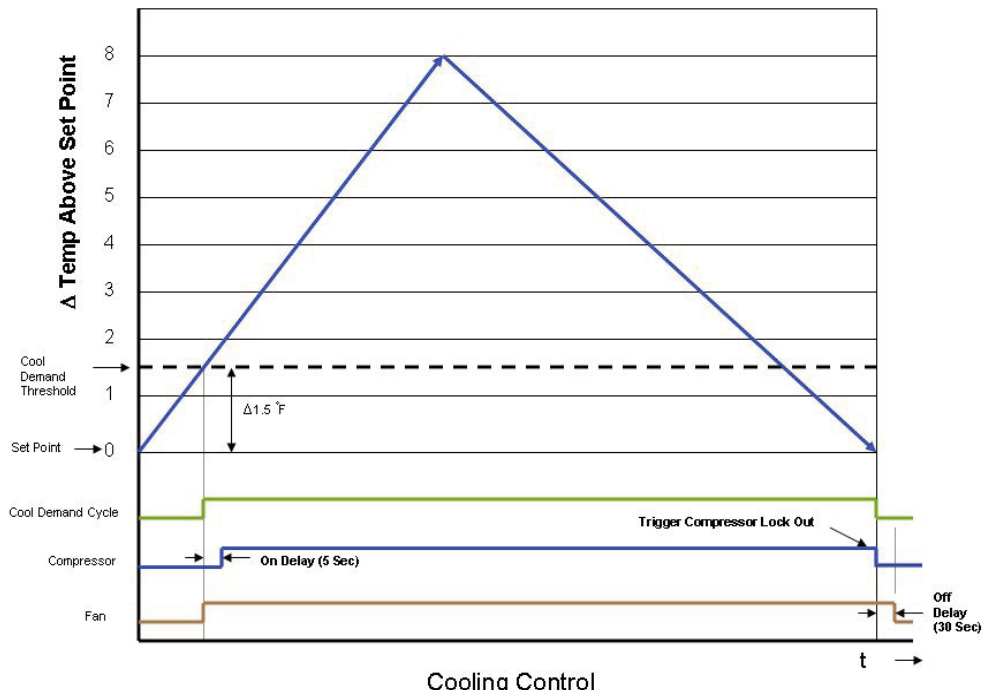

Figure 342 (Cooling Control)

OPERATION

Heat Control Operation - Electric Heat Only (KEQ08A11A)

When in the Heat mode, with and without Fan Mode Auto (Fan cycling):

If the indoor ambient temperature is below the Heat Demand Threshold (Heat Set Point minus 1.5 °F), turn on electric heat. If Ambient is 0.3 °F above the Heat Set Point turn off the electric heat.

System Mode Auto

This mode provides automatic change over between cool and heat. The auto mode runs based on the room ambient temperature vs. the Demand Thresholds. It is only available in Heat-Cool Unit.

Notes:

There is a buffer zone between the cool and heat set points where no heating or cooling is allowed to occur. It is critical that the Cool Demand Threshold be greater than the Heat Demand Threshold by a minimum of 3° while in the Auto System Mode. For example, if a user enters a value for the Auto Cooling Set Point that violates the minimum 3° rule, the Auto Heating Set Point will adjust accordingly.

Automatic Change Over Delay (Cool with Heat Units)

The change over delay ensures that any system heating or cooling over shoot does not trigger an opposite demand cycle. The change over delay = 15 min. This timer blocks the opposite demand cycle from running until the timer expires. As an example, if the last demand was a cool cycle, and another cool cycle is requested, the timer will not block the request. However, if the last demand cycle was a cool cycle, and heat cycle is requested, the timer will block the request until the change over delay is expired.

Compressor Lock Out Time

The lockout feature ensures that the compressor is de-energized for a period of time. The timer varies randomly from 180 to 240 seconds

The compressor lockout is initiated every time the compressor is "off" due to:

- (1) Satisfying the temperature set point
- (2) Changing mode to fan only or heat
- (3) Turning the unit off
- (4) Control is first plugged in or power is restored after failure
- (5) Line power is restored from a brown out condition

Cooling Fan Delay

Fan cycle/Auto mode only

When unit cycles cooling ON – starts the fan 5 seconds EARLY. When unit cycles cooling OFF – DELAYS the fan off for 30 seconds.

OPERATION

Heating Fan Delay

This is only for fan Mode Auto (Fan cycles with cool/heat operation) and not for continuous fan mode. When unit cycles Heating ON – starts the fan 5 seconds EARLY. When unit cycles Heating OFF – DELAYS the fan off for 15 seconds.

Fan Speed Change Delay

Relay activation is delayed by a minimum number of seconds. The default for this value is 2 seconds and is used to eliminate relay chatter.

System Mode Fan Only

The fan is turned on and runs at the specified manually set speed.

Only the Fan is turned on. Cool or Heat operation are off.

(This is different than FAN MODE ON where the fan is on with the cool or heat operation).

Fan Only Rules

1. If the SYSTEM FAN ONLY MODE is selected, the Auto fan mode is disabled, and the fan mode is forced to continuous. In addition, the auto fan speed is disabled. If the user presses the fan speed key, the menu will skip over the auto selection. The set point temperature display is off.
2. Any fan speed may be manually selected during Fan Only Mode.

Fan Operation (Front Panel Mode)

Heat – Cool – Auto – Fan Only

All Models have 3 speeds.

Fan ICON Detail

The Fan Speed ICON will Display as LOW, MED, or HI depending on which speed is selected .

OPERATION

General Knowledge Sequence Of Refrigeration

A good understanding of the basic operation of the refrigeration system is essential for the service technician. Without this understanding, accurate troubleshooting of refrigeration system problems will be more difficult and time consuming, if not (in some cases) entirely impossible. The refrigeration system uses four basic principles (laws) in its operation they are as follows:

1. "Heat always flows from a warmer body to a cooler body."
2. "Heat must be added to or removed from a substance before a change in state can occur"
3. "Flow is always from a higher pressure area to a lower pressure area."
4. "The temperature at which a liquid or gas changes state is dependent upon the pressure."

The refrigeration cycle begins at the compressor. Starting the compressor creates a low pressure in the suction line which draws refrigerant gas (vapor) into the compressor. The compressor then "compresses" this refrigerant vapor, raising its pressure and its (heat intensity) temperature.

The refrigerant leaves the compressor through the discharge Line as a hot High pressure gas (vapor). The refrigerant enters the condenser coil where it gives up some of its heat. The condenser fan moving air across the coil's finned surface facilitates the transfer of heat from the refrigerant to the relatively cooler outdoor air.

When a sufficient quantity of heat has been removed from the refrigerant gas (vapor), the refrigerant will "condense" (i.e. change to a liquid). Once the refrigerant has been condensed (changed) to a liquid it is cooled even further by the air that continues to flow across the condenser coil.

The design determines at exactly what point (in the condenser) the change of state (i.e. gas to a liquid) takes place. In all cases, however, the refrigerant must be totally condensed (changed) to a Liquid before leaving the condenser coil.

The refrigerant leaves the condenser Coil through the liquid line as a warm high pressure liquid. It next will pass through the refrigerant drier (if equipped). It is the function of the drier to trap any moisture present in the system, contaminants, and large particulate matter.

The liquid refrigerant next enters the metering device. The metering device is a capillary tube. The purpose of the metering device is to "meter" (i.e. control or measure) the quantity of refrigerant entering the evaporator coil.

In the case of the capillary tube this is accomplished (by design) through size (and length) of device, and the pressure difference present across the device.

Since the evaporator coil is under a lower pressure (due to the suction created by the compressor) than the liquid line, the liquid refrigerant leaves the metering device entering the evaporator coil. As it enters the evaporator coil, the larger area and lower pressure allows the refrigerant to expand and lower its temperature (heat intensity). This expansion is often referred to as "boiling or atomizing". Since the unit's blower is moving indoor air across the finned surface of the evaporator coil, the expanding refrigerant absorbs some of that heat. This results in a lowering of the indoor air temperature, or "cooling".

The expansion and absorbing of heat cause the liquid refrigerant to evaporate (i.e. change to a gas). Once the refrigerant has been evaporated (changed to a gas), it is heated even further by the air that continues to flow across the evaporator coil.

The particular system design determines at exactly what point (in the evaporator) the change of state (i.e. liquid to a gas) takes place. In all cases, however, the refrigerant must be totally evaporated (changed) to a gas before leaving the evaporator coil.

The low pressure (suction) created by the compressor causes the refrigerant to leave the evaporator through the suction line as a cool low pressure vapor. The refrigerant then returns to the compressor, where the cycle is repeated.

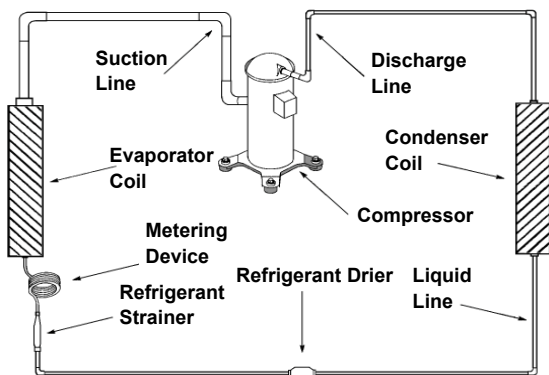
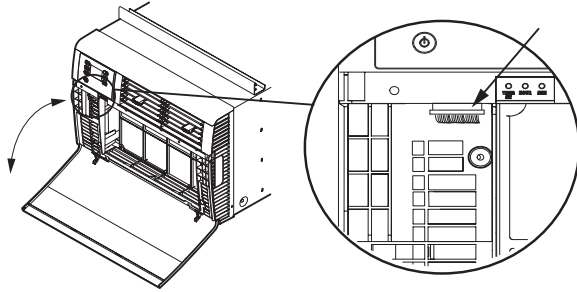

Figure 345 (Refrigeration Sequence Of Operation)

ROUTINE MAINTENANCE

REMOVE AND INSTALL THE FRONT COVER

⚠ WARNING	
	ELECTRIC SHOCK HAZARD Disconnect power to the unit before servicing. Failure to follow this warning could result in serious injury or death.



Remove the decorative front cover.

1. Remove EntryGard™ screws if installed.
2. Open the decorative front cover door.
3. Locate and disconnect electronic control power cable harness.
4. Remove 4 screws attaching decorative front cover. Save to reinstall later.
5. Remove decorative front cover. Store in a safe place to reinstall later.

Install the decorative front cover.

1. Reinstall the 4 screws attaching decorative front cover.
2. Locate and reconnect electronic control power cable harness.
3. Close the decorative front cover door.
4. Reinstall the EntryGard™ screws if installed.

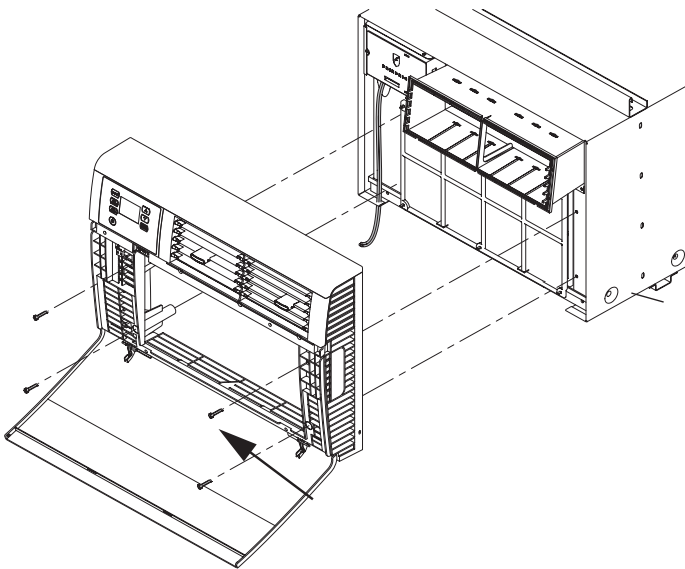

Figure 401 (Remove and Install the Front Cover)

ROUTINE MAINTENANCE

Coils & Chassis

NOTE: Do not use a caustic (alkaline) or acidic cleaning agent on coils or base pan. Use a biodegradable cleaning agent and degreaser. The use of harsh cleaning materials may lead to deterioration of the aluminum fins or the coil end plates.

The indoor coil and outdoor coils and base pan should be inspected periodically (annually or semi-annually) and cleaned of all debris (lint, dirt, leaves, paper, etc.) as necessary. Under extreme conditions, more frequent cleaning may be required. Clean the coils and base pan with a soft brush and compressed air or vacuum. A pressure washer may also be used; however, you must be careful not to bend the aluminum fin pack. Use a sweeping up and down motion in the direction of the vertical aluminum fin pack when pressure cleaning coils.

NOTE: It is extremely important to insure that none of the electrical and/or electronic parts of the unit get wet. Be sure to cover all electrical components to protect them from water or spray.

Decorative Front

Use a damp (not wet) cloth when cleaning the control area to prevent water from entering the unit, and possibly damaging the electronic control.

The decorative front and the cabinet can be cleaned with warm water and a mild liquid detergent. Do NOT use solvents or hydrocarbon based cleaners such as acetone, naphtha, gasoline, benzene, etc.

The indoor coil can be vacuumed with a dusting attachment if it appears to be dirty. DO NOT BEND FINS. The outdoor coil can be gently sprayed with a garden hose.

The air filter should be inspected weekly and cleaned if needed by vacuuming with a dust attachment or by cleaning in the sink using warm water and a mild dish washing detergent. Dry the filter thoroughly before reinstalling. Use caution, the coil surface can be sharp.

Fan Motor & Compressor

The fan motor & compressor are permanently lubricated and require no additional lubrication.

Wall Sleeve

Inspect the inside of the wall sleeve and drain system periodically (annually or semi-annually) and clean as required. Under extreme conditions, more frequent cleaning may be necessary. Clean both of these areas with an antibacterial and antifungal cleaner. Rinse both items thoroughly with water and ensure that the drain outlets are operating correctly. Check the sealant around the sleeve and reseal areas as needed.

Blower Wheel / Housing / Condenser Fan / Shroud

Inspect the indoor blower and its housing, evaporator blade, condenser fan blade and condenser shroud periodically (yearly or bi-yearly) and clean of all debris (lint, dirt, mold, fungus, etc.). Clean the blower housing area and blower wheel with an antibacterial / antifungal cleaner. Use a biodegradable cleaning agent and degreaser on condenser fan and condenser shroud. Use warm or cold water when rinsing these items. Allow all items to dry thoroughly before reinstalling them.

Electrical / Electronic

Periodically (at least yearly or bi-yearly) inspect all control components: electronic, electrical and mechanical, as well as the power supply. Use proper testing instruments (voltmeter, ohmmeter, ammeter, wattmeter, etc.) to perform electrical tests. Use an air conditioning or refrigeration thermometer to check room, outdoor and coil operating temperatures.

Air Filter

1) To ensure proper unit operation, the air filter should be cleaned at least monthly, and more frequently if conditions warrant. The unit must be turned off before the filter is cleaned.

2) To Remove, Wash and Replace Filter

Lower front panel (Figure 402). Use the handle on the filter to flex filter up and out of retainer. Remove filter from unit (Figure 403). Clean the filter monthly or more frequently if needed. Refer to the Accessories section for filter options.

ROUTINE MAINTENANCE

FILTER REMOVAL / INSTALLATION INSTRUCTIONS

1. Swing the door open, See Figure 402, and remove the filter by grasping the filter grips and pulling the bottom towards you. See Figure 403.
2. Clean the front frame by removing the carbon filter (if installed) and washing the dirt from the filter. Use a mild soap solution if necessary. Allow filter to dry.
NOTE: The carbon filter is not a reusable filter, and needs to be replaced every three months for optimum efficiency.
3. Install new carbon filter (optional) by aligning holes on carbon filter with tabs on mesh filter. (See Figure 404).
4. Install filter and close door. See Figures 402 and 403

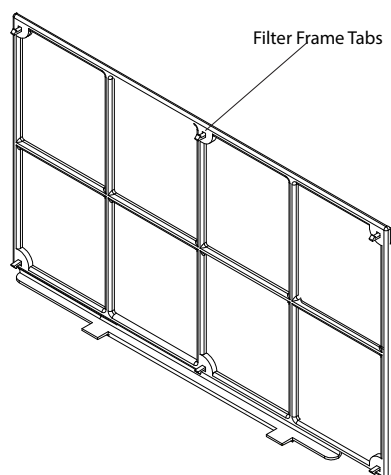
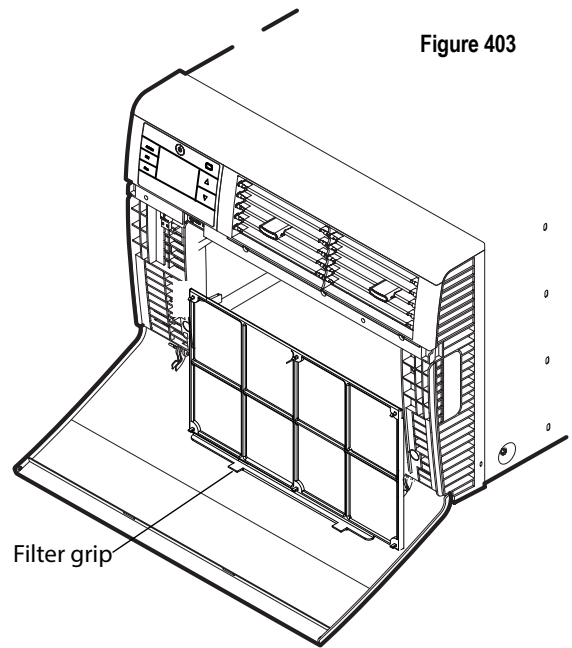
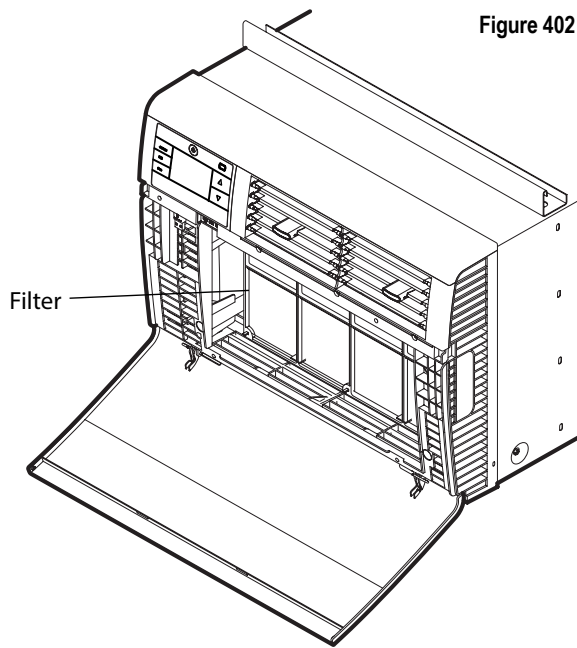

REMOVE AND INSTALL THE CHASSIS

REMOVE AND INSTALL THE CHASSIS

⚠ WARNING	
	ELECTRIC SHOCK HAZARD Disconnect power to the unit before servicing. Failure to follow this warning could result in serious injury or death.

Remove the chassis

1. Remove the EntryGard™ Screws. (Refer to Figure 501)
2. Hold the cabinet stationary then carefully slide the unit out of the sleeve. Make sure to fully support the unit. (Refer to Figure 502)

Install the Chassis

1. Carefully team lift the chassis and set it into the cabinet. (Refer to Figure 501)
2. Slide the chassis into the cabinet
3. Reinstall the EntryGard™ screws. (Refer to Figure 502)
4. Reinstall the EntryGard™ screws.. (Refer to Figure 502)

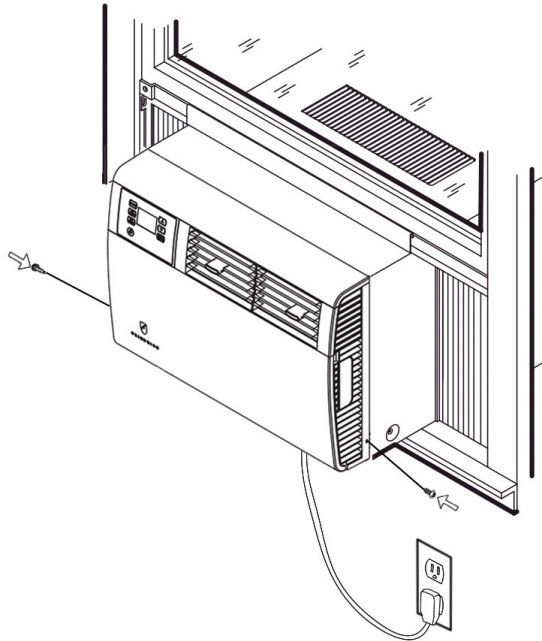

Figure 501 (Remove Entry Gard Screws)

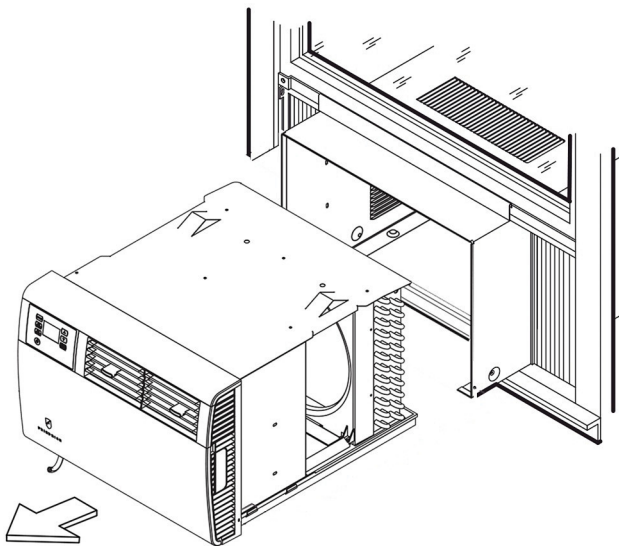

Figure 502 (Remove Chassis)

TROUBLESHOOTING

ROOM AIR CONDITIONER UNIT PERFORMANCE TEST DATA SHEET		
JOB NAME _____	TECH'S NAME _____	
DATE _____	MODEL# _____	SERIAL # _____
CHECK THE INSTALLATION	ACCEPTABLE YES	NOT ACCEPTABLE NO
IS A CHASIS GASKET INSTALLED?	_____	_____
IS THE FRESH / EXHAUST AIR VENT OPEN?	_____	_____
IS A FRIEDRICH SLEEVE INSTALLED?	_____	_____
IS A FRIEDRICH OUTDOOR GRILLE INSTALLED?	_____	_____
IS MAINTENANCE BEING PERFORMED?	_____	_____
ELECTRICAL		
LINE VOLTAGE (STATIC)	_____	VOLTS
START UP VOLTAGE	_____	VOLTS
AMPERAGE DRAW (COOL)	_____	AMPS
AMPERAGE DRAW (HEAT)	_____	AMPS
COMPRESSOR		
LOCKED ROTOR AMPS	_____	AMPS
RUNNING AMPERAGE DRAW	_____	AMPS
INDOOR CONDITIONS		
INDOOR AMBIENT TEMPERATURE	_____	F
RELATIVE HUMIDITY (RH) INDOOR	_____	%
DISCHARGE AIR TEMPERATURE (INDOOR)(COOL)	_____	F
DISCHARGE AIR TEMPERATURE (INDOOR)(HEAT)	_____	F
RETURN AIR TEMPERATURE (INDOOR)(COOL)	_____	F
RETURN AIR TEMPERATURE (INDOOR) (HEAT)	_____	F
OUTDOOR TEMPERATURE		
OUTDOOR AMBIENT TEMPERATURE	_____	F
RH OUTDOOR RELATIVE HUMIDITY	_____	%
DISCHARGE AIR TEMPERATURE (OUTDOOR)(COOL)	_____	F
DISCHARGE AIR TEMPERATURE (OUTDOOR)(HEAT)	_____	F
INTAKE AIR TEMPERATURE (OUTDOOR)(COOL)	_____	F
INTAKE AIR TEMPERATURE (OUTDOOR)(HEAT)	_____	F
COOLING OR HEATING AREA		
AREA W _____ * L _____ = FEET SQUARED		
FOR A GENERAL GUIDE REFER TO SIZING GUIDE TO THE RIGHT		
FOR EXACT LOAD CALCULATIONS CONSULT MANUAL J OR M.		

Figure 708 (Test Data Sheet)

COOLING SIZING GUIDE

AREA TO BE CONDITIONED IN SQ. FT.	APPROXIMATE COOLING BTU REQUIRED
100 - 150	5000
150 - 250	6000
250 - 300	7000
300 - 350	8000
350 - 400	9000
400 - 450	10000
450 - 550	12000
550 - 700	14000
700 - 1000	18000
1000 - 1200	21000
1200 - 1400	23000
1400 - 1500	24000
1500 - 2000	30000
2000 - 2500	34000

Guide based on normal room

insulation, average number of
sun exposed windows and two
person occupancy.

1. If heavily shaded, reduce cooling Btus required by 10%
2. If very sunny, increase cooling Btus required by 10%
3. Add 500 Btus per person over 2 people
4. Add 4,000 Btus if the area is a kitchen

Figure 709 (Cooling Sizing Guide)

TROUBLESHOOTING

Diagnostic Codes

FAULT CODE	PROBLEM	CONTROL BOARD'S ACTION
1	Front Panel Button Stuck For More Than 20 Seconds	Continue to monitor for "OPEN" (Unstuck) switch. Do not process switch input. ENSURE FRONT COVER DOES NOT DEPRESS BUTTONS
3	Indoor Temperature Sensor is Open or Shorted	Set temp to 75°F in COOLING or 68°F in HEATING. Unit continues to operate
4	Indoor Coil Temperature Sensor is Open or Shorted	Control Board sets temp to a default of 40°F. Override sensor. Unit continues to operate.
5	Outdoor Coil Temperature Sensor is Open or Shorted	Sets temp to 20°F. Override sensor. Continue operation. Use Electric Heat if available for HEATING. If not available use HEAT PUMP if outdoor temp allows.
6	Outdoor Coil > (greater than) 175 °F	Shut down for 5 min.
7	Indoor Coil < (less than) 30 °F for 2 consecutive minutes	Turn compressor off. When coil temp reaches 45°F resume operation after lockout time.
8	Unit Cycles > (grater than) 9 Times per hour	Continue operation. Continue to monitor. Take no action. Log Only.
9	Unit Cycles < (less than) 3 Times per Hour	Continue operation. Continue to monitor. Take no action. Log Only.
12	Discharge Air > (greater than) 185 °F	Shutdown electric heater until temp is 100°F. Resume operation.
14	Discharge Air Temperature Sensor is Open or Shorted	Override Sensor. Set temp to 75°F. Continue to monitor. Set error code 14 ON.
16	Temperature Beyond Operating Limits	Ambient temp < (less than) 0°F and ambient temp > (greater than) 130°F. Set error code 16 ON. When cleared return unit to normal.
22	Outdoor Coil Temperature < 30 °F for 2 consecutive Minutes	Unit will use electric heat to satisfy heating demands until temp is greater than 45°F. Unit must be a Heat Pump with electric heat.
23	Frost Protection.	Unit will run active defrost for up to 6 minutes when Heat Pump run time is greater than 60 minutes and outdoor coil temp is 26 °F or less.

Figure 710 (Fault Codes)

TROUBLESHOOTING

Tips

Problem	Possible Cause	Possible Solution
Unit does not operate.	The power button is off or the set point temperature is satisfied.	Push the power button on and raise or lower temperature setting (as appropriate) to call for operation.
	The LCDI power cord is unplugged.	Plug into a properly grounded 3 prong receptacle. (See Electrical Rating Tables, Figure 205) for the proper receptacle type for your unit.
	The LCDI power cord has tripped (Reset button has popped out).	Press and release RESET (Listen for click. Reset button latches and remains in.) Check that the green LED light is on to resume operation.
	The circuit breaker has tripped or the supply circuit fuse has blown.	Reset the circuit breaker, or replace the fuse as applicable. If the problem continues, contact a licensed electrician.
	There has been a local power failure.	The unit will resume normal operation once power has been restored.
Unit Trips Circuit Breaker or Blows Fuses.	Other appliances are being used on the same circuit. (115 Volt only)	The unit requires a dedicated outlet circuit, not shared with other appliances.
	An extension cord is being used.	Do NOT use an extension cord with this or any other air conditioner.
	The circuit breaker or time-delay fuse is not of the proper rating.	Replace with a circuit breaker or time-delay fuse of the proper rating. (See Electrical Rating Tables, Figure 205) for the proper circuit breaker/fuse rating for your unit. If the problem continues, contact a licensed electrician.
LCDI Power Cord Trips (Reset Button Pops Out).	The LCDI power cord can trip (Reset button pops out) due to disturbances on your power supply line.	Press and release RESET (Listen for click. Reset button latches and remains in.) Check that the green LED is on to resume normal operation.
	Electrical overload, overheating, or cord pinching can trip (Reset button pops out) the LCDI power cord.	Once the problem has been determined and corrected, press and release RESET (Listen for click. Reset button latches and remains in.) to resume normal operation.
	NOTE: A damaged power supply cord must be replaced with a new power supply cord obtained from the product manufacturer and must not be repaired.	
Unit Does Not Cool/Heat Room Sufficiently, or Cycles On And Off Too Frequently.	• The return/discharge air grille is blocked.	• Ensure that the return and/or discharge air paths are not blocked by curtains, blinds, furniture, etc.
	• Windows or doors to the outside are open.	• Ensure that all windows and doors are closed.
	• The temperature is not set at a cool enough/warm enough setting.	• Adjust the Temperature control to a cooler or warmer setting as necessary.
	• The filter is dirty or obstructed.	• Clean the filter, (see Routine Maintenance), or remove obstruction.
	• The indoor coil or outdoor coil is dirty or obstructed.	• Clean the coils, (see Routine Maintenance), or remove obstruction.
	• There is excessive heat or moisture (cooking, showers, etc.) in the room.	• Be sure to use exhaust vent fans while cooking or bathing and, if possible, try not to use heat producing appliances during the hottest part of the day.
	• The temperature of the room you are trying to cool is extremely hot.	• Allow additional time for the air conditioner to cool off a very hot room.

Figure 711 (Troubleshooting Tips)

TROUBLESHOOTING

Tips Continued

COMPLAINT	CAUSE	SOLUTION
Unit Does Not Cool/ Heat Room Sufficiently, or Cycles On And Off Too Frequently (continued).	Operating in Cooling mode while the outside temperature is below 60°F (16°C).	Do not try to operate your air conditioner in the cooling mode when the outside temperature is below 60°F (16°C). The unit will not cool properly, and the unit may be damaged.
	The digital control is set to fan cycling mode.	Since the fan does not circulate the room air continuously at this setting, the room air does not mix as well and hot (or cold) spots may result. Using the continuous fan setting is recommended to obtain optimum comfort levels.
	The air conditioner has insufficient cooling capacity to match the heat gain of the room.	Check the cooling capacity of your unit to ensure it is properly sized for the room in which it is installed. Room air conditioners are not designed to cool multiple rooms.
	The air conditioner has insufficient heating capacity to match the heat loss of the room.	Check the heating capacity of your unit. Air conditioners are sized to meet the cooling load, and heater size is then selected to meet the heating load. In extreme northern climates, room air conditioners may not be able to be used as a primary source of heat.
Unit Runs Too Much.	This may be due to an excessive heat load in the room.	If there are heat producing appliances in use in the room, or if the room is heavily occupied, the unit will need to run longer to remove the additional heat.
	It may also be due to an improperly sized unit.	Be sure to use exhaust vent fans while cooking or bathing and, if possible, try not to use heat producing appliances during the hottest part of the day.
	The LCDI power cord has tripped (Reset button has popped out).	Press and release RESET (Listen for click. Reset button latches and remains in.) Check that the green LED light is on to resume operation.
Compressor does not run.	Low voltage	Check voltage at compressor. 115V units will operate at 10% voltage variance
	Temperature not set cold enough or room air thermistor inoperative	Set temperature to lower than ambient position. Test thermistor and replace if inoperative.
	Compressor hums but cuts off on overload	Direct test compressor.
	Open overload	Test overload protector & replace if inoperative
	Open capacitor	Test capacitor & replace if inoperative
	Inoperative power button	Test for continuity in all positions. Replace User Interface if switch inoperative.
	Broken, loose or incorrect wiring	Refer to appropriate wiring diagrams to check wiring. Correct as needed.

Figure 711 (Troubleshooting Tips)

TROUBLESHOOTING

Tips Continued

COMPLAINT	CAUSE	SOLUTION
Fan motor does not run.	Inoperative system button	Test button & replace user interface if inoperative
	Broken, loose or incorrect wiring	Refer to applicable wiring diagram
	Open capacitor	Test capacitor & replace if inoperative
	Fan speed button defective	Replace user interface if inoperative
	Inoperative fan motor	Test fan motor & replace if inoperative (be sure internal overload has had time to reset)
Does not cool or only cools slightly	Undersized unit	Refer to industry standard sizing chart
	Indoor ambient thermistor open or shorted	See diagnostic codes and replace thermistor if needed.
	Dirty filter	Clean as recommended in Owner's Manual
	Dirty or restricted condenser or evaporator coil	Use pressure wash or biodegradable cleaning agent to clean
	Poor air circulation	Adjust discharge louvers. Use high fan speed
	Fresh air or exhaust air door open	Close doors. Instruct customer on use of this feature
	Low capacity - undercharge	Check for leak & make repair
	Compressor not pumping properly	Check amperage draw against nameplate. If not conclusive, make pressure test
Unit does not run	Fuse blown or circuit tripped	Replace fuse, reset breaker. If repeats, check fuse or breaker size. Check for shorts in unit wiring & components
	Loose or disconnected wiring control board or other components	Check wiring & connections. Reconnect per wiring diagram
Evaporator coil freezes up	Dirty filter	Clean filter (see Routine Maintenance)
	Restricted airflow	Check for dirty or obstructed coil. Clean coil (refer to routine Maintenance)
	Inoperative thermistor	Check Diagnostic Codes. Check Thermistors and replace as necessary.
	Short of refrigerant	De-ice coil & check for leak
	Inoperative fan motor	Test fan motor & replace if inoperative
	Partially restricted capillary tube	De-ice coil. Replace capillary tube
Compressor runs continually & does not cycle off	Excessive heat load	Unit undersized. Test cooling performance & replace with larger unit if needed. See sizing chart.
	Restriction in line	Check for partially iced coil & check temperature split across coil
	Thermistor shorted	Replace thermistor or electronic control board

TROUBLESHOOTING

Tips Continued

COMPLAINT	CAUSE	SOLUTION
Electronic control board does not turn unit off	Compressor relay contacts stuck	Replace electronic control board
	Incorrect wiring	Refer to appropriate wiring diagrams
	Unit undersized for area to be cooled	Refer to industry standard sizing chart
	Defective thermistor	Replace thermistor or electronic control board
Compressor runs for short periods only.	Incorrect wiring	Refer to appropriate wiring diagram
	Shorted or incorrect capacitor	Test capacitor and replace if needed.
	Restricted or low air flow through condenser coil or evaporator coil	Check for proper fan speed or blocked coils. Correct as needed.
	Compressor running abnormally hot	Check for kinked discharge line or restricted condenser. Refrigerant overcharge. Check amperage, connections.
Unit does not turn on	No power	Check power supply. Check LCDI plug. Check wire connections. Check if panel is locked.
	Incorrect wiring	Refer to appropriate wiring diagram
	Defective thermistor	Replace thermistor or electronic control board
Noisy operation	Poorly installed	Refer to Installation Manual for proper installation
	Fan blade striking chassis	Reposition - adjust motor mount
	Compressor vibrating	Check that compressor grommets have not deteriorated. Check that compressor mounting parts are not missing
	Improperly mounted or loose cabinet parts refrigerant tubes	Check assembly & parts for looseness, rubbing & rattling pipes, etc.
Water Leaks into Room	Evaporator drain pan overflowing	Clean obstructed drain trough
	Condensation forming underneath base pan	Evaporator drain pan broken or cracked. Reseal or replace. No chassis gasket installed. Install chassis gasket
	Poor installation resulting in rain entering the room	Check installation instructions. Reseal as required
	Condensation on discharge grille louvers	Dirty evaporator coil. Clean coils (See Routine Maintenance) Environmental phenomena: point supply louvers upward. Put on high fan.
	Chassis gasket not installed	Install gasket, per Installation manual
	Downward slope of unit is too steep inward	Refer to installation manual for proper installation

TROUBLESHOOTING

Tips Continued

COMPLAINT	CAUSE	SOLUTION
Water "spitting" into room	Sublimation: When unconditioned saturated, outside air mixes with conditioned air, condensation forms on the cooler surfaces	Ensure that foam gaskets are installed in between window panes & in between the unit & the sleeve. Also, ensure that fresh air/exhaust vents (on applicable models) are in the closed position & are in tact
	Downward pitch of installation is too steep towards back of unit	Follow installation instructions to ensure that downward pitch of installed unit is no less than 1/4" & no more than 3/8"
	Restricted coil or dirty filter	Clean & advise customer of periodic cleaning & maintenance needs of entire unit
Excessive moisture	Insufficient air circulation thru area to be air conditioned	Adjust louvers for best possible air circulation
	Inadequate vapor barrier in building structure; particularly floors.	Advise customer
Unit short cycles	Defective thermistor	Replace thermistor or electronic control board
	Unit oversized	See sizing chart. Correct as needed.
	Chassis seal gasket not sealing or absent causing unit to short cycle	Check gasket. Reposition or replace as needed
	Restricted coil or dirty filter.	Clean & advise customer of periodic cleaning & maintenance needs of entire unit
Prolonged off cycles	Defective indoor ambient thermistor or electronic control board	Check alarms. Replace thermistor or electronic control board
Outside water leaks	Evaporator drain pan cracked or obstructed	Repair, clean or replace as required
	Obstructed condenser coil	Use pressure wash or biodegradable cleaning agent to clean
	Fan blade/slinger ring improperly positioned	Adjust fan blade to 1/2" of condenser coil fin pack
Room temperature uneven (Heating cycle)	Bad indoor ambient thermistor	Check diagnostic codes. Check Thermistors. Replace as needed.
	Fan speed too low	Set at higher fan speed.
Does not heat adequately	Dirty filter.	Clean (See Routine Maintenance)
	Unit undersized	Check heat rise across coil. If unit operates efficiently, check if insulation can be added to attic or walls. If insulation is adequate, recommend additional unit or larger one
	Heater hi-limit control cycling on & off	Check for adequate fan air across heater. Check for open hi-limit control.
	Shorted or open supplementary heater	Do ohmmeter check.
	Incorrect wiring	Check applicable wiring diagram

TROUBLESHOOTING

Tips Continued

AIR CONDITIONERS: TROUBLE SHOOTING TIPS

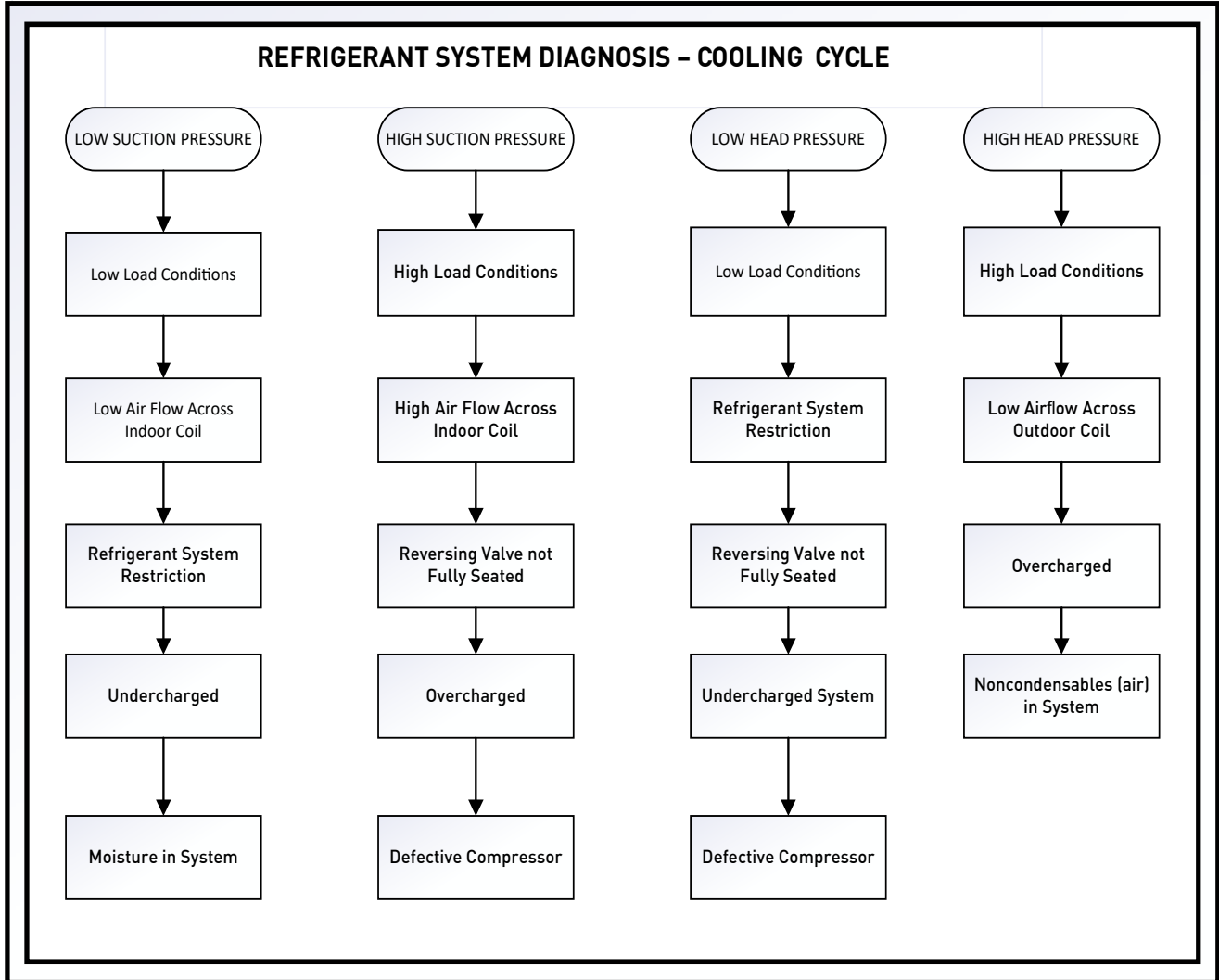



Figure 712 (Trouble Shooting Tips)

COMPONENT TESTING

Compressor Checks

⚠ WARNING	
	ELECTRIC SHOCK HAZARD Turn off electric power before service or installation. All electrical connections and wiring MUST be installed by a qualified electrician and conform to the National Electrical Code and all local codes which have jurisdiction. Failure to do so can result in personal injury or death.

⚠ WARNING	
	BURN HAZARD Proper safety procedures must be followed, and proper protective clothing must be worn when working with a torch. Failure to follow these procedures could result in moderate or serious injury.

Locked Rotor Voltage (L.R.V.) Test

Locked rotor voltage (L.R.V.) is the actual voltage available at the compressor under a stalled condition.

Single Phase Connections

Disconnect power from unit. Using a voltmeter, attach one lead of the meter to the run "R" terminal on the compressor and the other lead to the common "C" terminal of the compressor. Restore power to unit.

Determine L.R.V.

Start the compressor with the volt meter attached; then stop the unit. Attempt to restart the compressor within a couple of seconds and immediately read the voltage on the meter. The compressor under these conditions will not start and will usually kick out on overload within a few seconds since the pressures in the system will not have had time to equalize. Voltage should be at or above minimum voltage of 197 VAC, as specified on the rating plate. If less than minimum, check for cause of inadequate power supply; i.e., incorrect wire size, loose electrical connections, etc.

Amperage (R.L.A.) Test

The running amperage of the compressor is the most important of these readings. A running amperage higher than that indicated in the performance data indicates that a problem exists mechanically or electrically.

Single Phase Running and L.R.A. Test

NOTE: Consult the specification and performance section for running amperage. The L.R.A. can also be found on the rating plate.

Select the proper amperage scale and clamp the meter probe around the wire to the "C" terminal of the compressor.

Turn on the unit and read the running amperage on the meter. If the compressor does not start, the reading will indicate the locked rotor amperage (L.R.A.).

Overloads

The compressor is equipped with either an external or internal overload which senses both motor amperage and winding temperature. High motor temperature or amperage heats the overload causing it to open, breaking the common circuit within the compressor. Heat generated within the compressor shell, usually due to recycling of the motor, is slow to dissipate. It may take anywhere from a few minutes to several hours for the overload to reset.

Checking the Overloads

CAUTION: Before attempting to check overloads, ensure that compressor is cool to touch.

External Overloads

With power off, remove the leads from compressor terminals. If the compressor is hot, allow the overload to cool before starting check. Using an ohmmeter, test continuity across the terminals of the external overload. If you do not have continuity; this indicates that the overload is open and must be replaced.

Internal Overloads

Some model compressors are equipped with an internal overload. The overload is embedded in the motor windings to sense the winding temperature and/or current draw. The overload is connected in series with the common motor terminal.

Should the internal temperature and/or current draw become excessive, the contacts in the overload will open, turning off the compressor. The overload will automatically reset, but may require several hours before the heat is dissipated.

Checking the Internal Overload

1. With no power to unit, remove the leads from the compressor terminals.
2. Using an ohmmeter, test continuity between terminals C-S and C-R. If no continuity, and the compressor is not hot to the touch, the compressor overload is open, and the compressor should be replaced.

COMPONENT TESTING Compressor Checks

⚠ WARNING	
	ELECTRIC SHOCK HAZARD Turn off electric power before service or installation. Extreme care must be used, if it becomes necessary to work on equipment with power applied.
	Failure to do so could result in serious injury or death.

⚠ WARNING	
	HIGH PRESSURE HAZARD Sealed Refrigeration System contains refrigerant and oil under high pressure.
	Proper safety procedures must be followed, and proper protective clothing must be worn when working with refrigerants. Failure to follow these procedures could result in serious injury or death.

Single Phase Resistance Test

Remove the leads from the compressor terminals and set the ohmmeter on the lowest scale (R x 1).

Touch the leads of the ohmmeter from terminals common to start ("C" to "S"). Next, touch the leads of the ohmmeter from terminals common to run ("C" to "R").

Add values "C" to "S" and "C" to "R" together and check resistance from start to run terminals ("S" to "R"). Resistance "S" to "R" should equal the total of "C" to "S" and "C" to "R."

In a single phase PSC compressor motor, the highest value will be from the start to the run connections ("S" to "R"). The next highest resistance is from the start to the common connections ("S" to "C"). The lowest resistance is from the run to common. ("C" to "R") Before replacing a compressor, check to be sure it is defective.

GROUND TEST

Use an ohmmeter set on its highest scale. Touch one lead to the compressor body (clean point of contact as a good connection is a must) and the other probe in turn to each compressor terminal. If a reading is obtained the compressor is grounded and must be replaced.

Check the complete electrical system to the compressor and compressor internal electrical system, check to be certain that compressor is not out on internal overload.

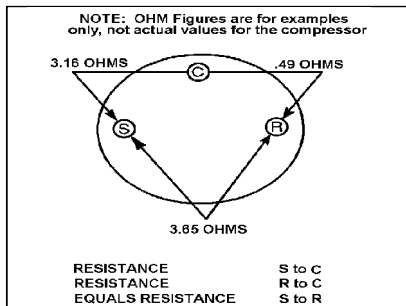

Figure 701a (Resistance Chart)

Complete evaluation of the system must be made whenever you suspect the compressor is defective. If the compressor has been operating for sometime, a careful examination must be made to determine why the compressor failed.

Many compressor failures are caused by the following conditions:

1. Improper air flow over the evaporator.
2. Overcharged refrigerant system causing liquid to be returned to the compressor.
3. Restricted refrigerant system.
4. Lack of lubrication.
5. Liquid refrigerant returning to compressor causing oil to be washed out of bearings.
6. Noncondensables such as air and moisture in the system. Moisture is extremely destructive to a refrigerant system.
7. Capacitor.

CHECKING COMPRESSOR EFFICIENCY

The reason for compressor inefficiency is normally due to broken or damaged suction and/or discharge valves, reducing the ability of the compressor to pump refrigerant gas.

NOTE: Before installing valves and gauges, check the compressor discharge temperature and compressor current, Low compressor amperage combined with low discharge temperature is an indication that the compressor might be faulty,

This condition can be checked as follows:

1. Install a piercing valve on the suction and discharge or liquid process tube.
2. Attach gauges to the high and low sides of the system.-
3. Start the system and run a "cooling or heating performance test." If test shows:
 - A. Below normal high side pressure
 - B. Above normal low side pressure
 - C. Low temperature difference across coil

The compressor valves are faulty - replace the compressor.

COMPONENT TESTING

Capillary Tube Assy (Cool Only Units)

Test the Capillary Tube and Check Valve Assy

1. Check the capillary tube temperature by hand where the refrigerant enters the capillary tube. A partial restriction of the capillary tube will be indicated by frost or freezing in that area.
2. If the capillary tube is fully restricted, then pressure will increase and pressure switch will open if installed. If no pressure switch is installed, the unit will shut down due to the compressor overload opening. High discharge temperature will be present at the compressor.

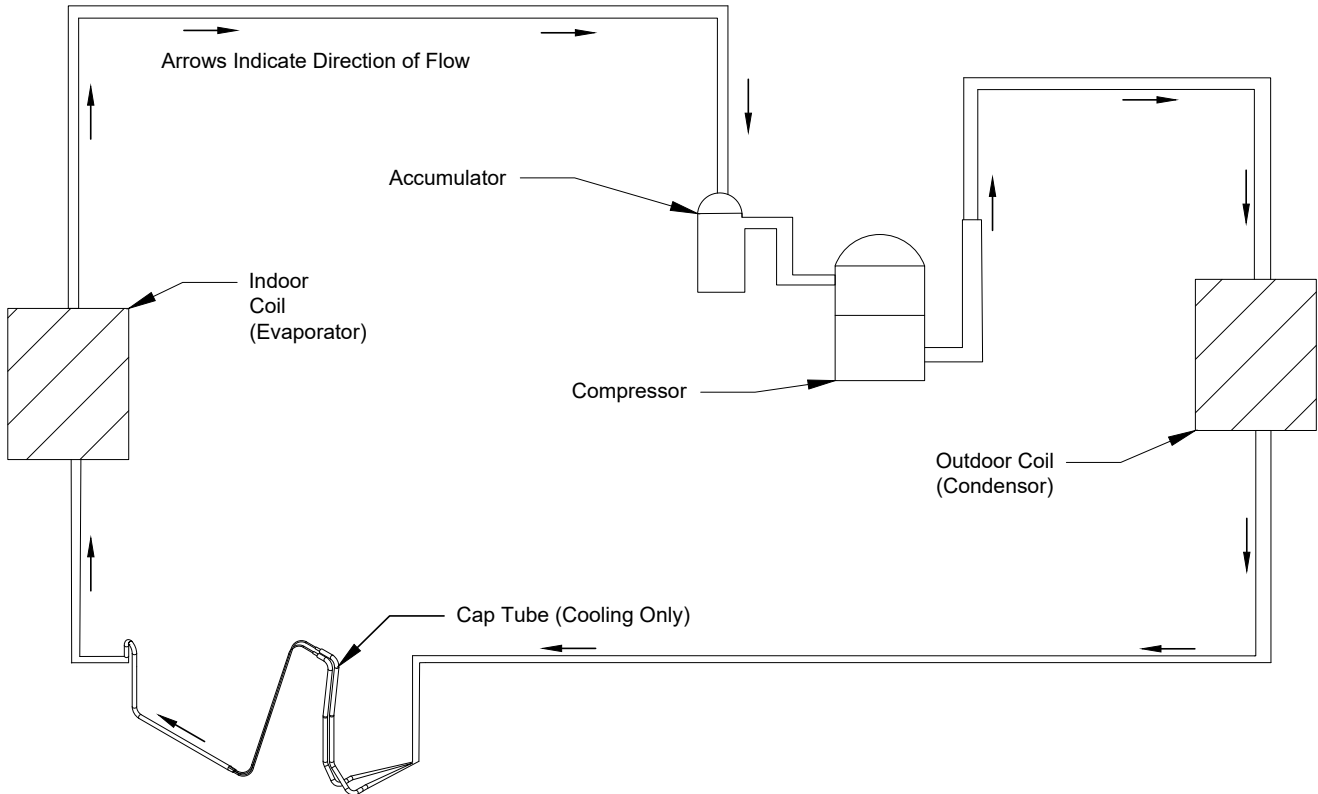



Figure 701b (Cooling Only Refrigerant Flow)

COMPONENTS TESTING

Fan Motor

A single phase permanent split capacitor motor is used to drive the evaporator blower and condenser fan. A self-resetting overload is located inside the motor to protect against high temperature and high amperage conditions.

⚠ WARNING	
	<p>ELECTRIC SHOCK HAZARD Turn off electric power before service or installation. Extreme care must be used, if it becomes necessary to work on equipment with power applied.</p> <p>Failure to do so could result in serious injury or death.</p>

Blower/Fan Motor

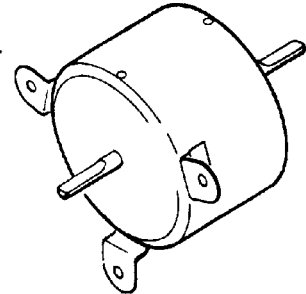



Figure 702 (Blower)

Blower / Fan Motor Test

1. Check Capacitor as shown below.
2. Place the unit into fan only mode, and verify proper voltage at motor leads.
3. If proper voltage exists, replace fan motor.

Capacitors

⚠ WARNING	
	<p>ELECTRIC SHOCK HAZARD Turn off electric power before service or installation. Extreme care must be used, if it becomes necessary to work on equipment with power applied.</p> <p>Failure to do so could result in serious injury or death.</p>

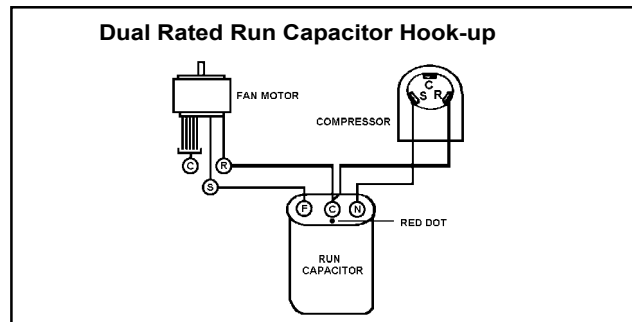

Figure 703 Dual Rated Capacitor Hook-Up

Many motor capacitors are internally fused. Shorting the terminals will blow the fuse, ruining the capacitor. A 20,000 ohm 2 watt resistor can be used to discharge capacitors safely. Remove wires from capacitor and place resistor across terminals. When checking a dual capacitor with a capacitor analyzer or ohmmeter, both sides must be tested.

Capacitor Check

The capacitor analyzer will show whether the capacitor is "open" or "shorted." It will tell whether the capacitor is within its micro farads rating and it will show whether the capacitor is operating at the proper power-factor percentage. The instrument will automatically discharge the capacitor when the test switch is released.

Capacitor Connections

The starting winding of a motor can be damaged by a shorted and grounded running capacitor. This damage usually can be avoided by proper connection of the running capacitor terminals.

From the supply line on a typical 230 volt circuit, a 115 volt potential exists from the "R" terminal to ground through a possible short in the capacitor. However, from the "S" or start terminal, a much higher potential, possibly as high as 400 volts, exists because of the counter EMF generated in the start winding. Therefore, the possibility of capacitor failure is much greater when the common terminal is connected to the "S" or start terminal. The common terminal should always be connected to the supply line, or "R" terminal, never to the "S" terminal.

When connected properly, a shorted or grounded running capacitor will result in a direct short to ground from the "R" terminal and will blow the line fuse. The motor protector will protect the main winding from excessive temperature.

COMPONENTS TESTING

Heating Element

⚠ WARNING	
	ELECTRIC SHOCK HAZARD Turn off electric power before service or installation. Extreme care must be used, if it becomes necessary to work on equipment with power applied.
	Failure to do so could result in serious injury or death.

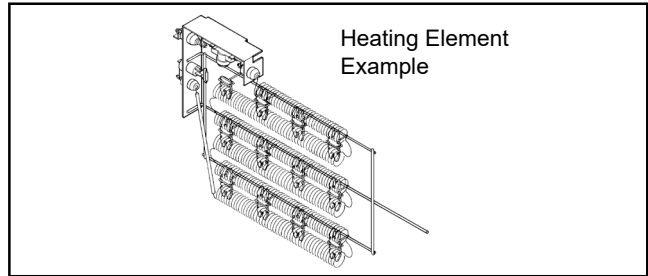

Figure 704 (Heating Element)

Electric heat models are equipped with a heating element. The KEQ08A11A Model is equipped with a 1.15 kw (@115 Volts) Heating Element. The heating element contains a fuse link and a heater limit switch. The fuse link is in series with the power supply and will open and interrupt the power when the temperature reaches 199°F or a short circuit occurs in the heating element. Once the fuse link separates, a new heater element must be installed.

NOTE: Always replace heating element with the exact replacement.

The heater element has a high limit control. This control is a bimetal thermostat mounted in the top of the heating element. Should the fan motor fail or filter become clogged, the high limit control will open and interrupt power to the heater before reaching an unsafe temperature condition. The control is designed to open at 110°F ±6°F. Test continuity below 110°F or when it is cooled off.

TESTING THE HEATING ELEMENT

Testing of the elements can be made with an ohmmeter across the terminals after the connecting wires have been removed. A cold resistance reading of approximately 10.11 ohms for the 1.15 KW heater should be registered.

Drain Pan Valve

During the cooling mode of operation, condensate which collects in the drain pan is picked up by the con-denser fan blade and sprayed onto the condenser coil. This assists in cooling the refrigerant plus evaporating the water. During the heating mode of operation, it is necessary that water be removed to prevent it from freezing during cold outside temperatures. This could cause the con-denser fan blade to freeze in the accumulated water and prevent it from turning. To provide a means of draining this water, a bellows type drain valve is installed over a drain opening in the base pan. This valve is temperature sensitive and will open when the outside temperature reaches 40°F. The valve will close gradually as the temperature rises above 40°F to fully close at 60°F.

DRAIN PAN VALVE

During the cooling mode of operation, condensate which collects in the drain pan is picked up by the con-denser fan blade and sprayed onto the condenser coil. This assists in cooling the refrigerant plus evaporating the water.

During the heating mode of operation, it is necessary that water be removed to prevent it from freezing during cold outside temperatures. This could cause the con-denser fan blade to freeze in the accumulated water and prevent it from turning.

To provide a means of draining this water, a bellows type drain valve is installed over a drain opening in the base pan. This valve is temperature sensitive and will open when the outside temperature reaches 40°F. The valve will close gradually as the temperature rises above 40°F to fully close at 60°F.

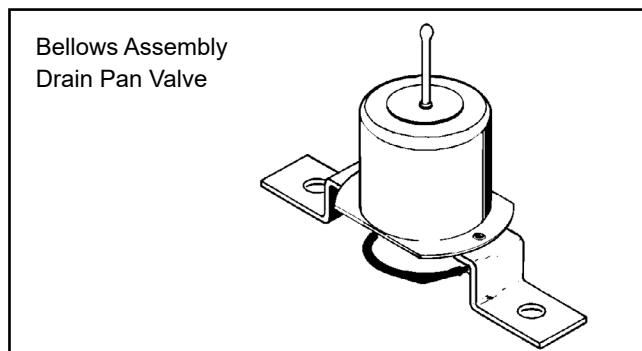



Figure 705 Drain Pan Valve

COMPONENTS TESTING

⚠ WARNING	
	ELECTRIC SHOCK HAZARD Turn off electric power before service or installation. Extreme care must be used, if it becomes necessary to work on equipment with power applied. Failure to do so could result in serious injury or death.

Testing the User Interface and Electronic Control Board

If the User Interface does not turn on:

1. Make sure the unit has the proper voltage and that it is turned on. Check power at Terminals L1 and L2. (Refer to Electronic Control Board Identification, Fig 707)
2. Disconnect the User Interface's wire harness on the control board.
3. Using a voltmeter, check the outer pins on the user interface port of the electronic control board . There should be 24VDC. (Refer to Electronic Control Board Identification, Fig 707)
4. If there is no voltage, replace the electronic control board.
5. If 24 VDC is present replace the User Interface and/ or the ribbon cable.

Thermistors Description

The KUHL units have 4 sensors (Thermistors). Each thermistor is color coded and has a different function.

1. Indoor Coil (Yellow) - located on the evaporator coil next to the power board
2. Outdoor Coil (Blue) - located on the condenser coil.
3. Discharge Air (Black) - located on the front of the unit in the discharge air port.
4. Ambient Air (White) - located on the front of the unit in front of the air intake

Thermistor Testing

1. Gain access to Electronic Control Board.
2. Locate thermistor plug and disconnect from Control Board. (Refer to Control Board Identification, Flg 707)
3. Check for proper resistance. (Refer to Thermistor Resistance values, Fig 707)
4. If thermistor is out of tolerance, replace thermistor.

COMPONENTS TESTING

Electronic Control Board Identification

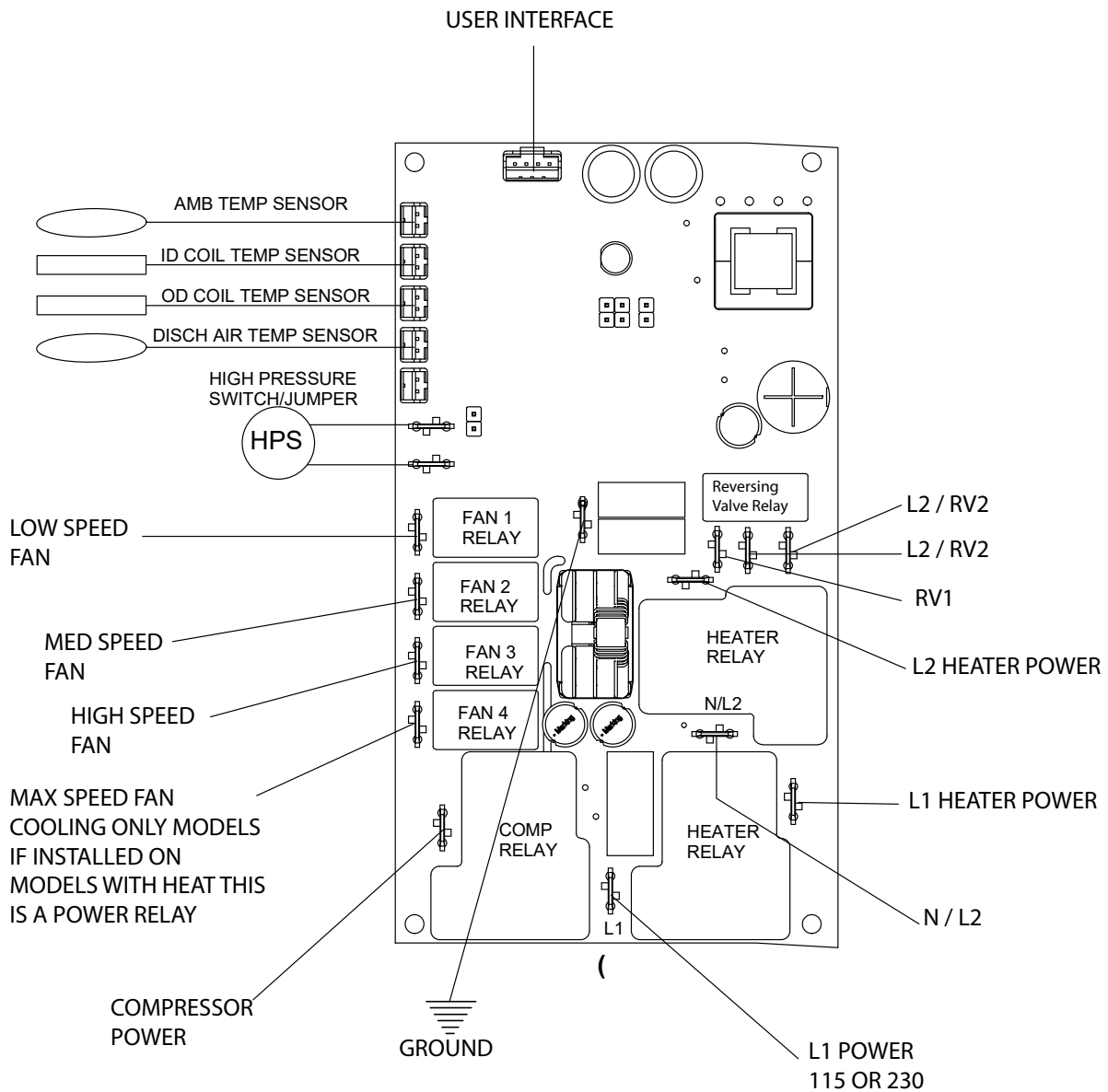
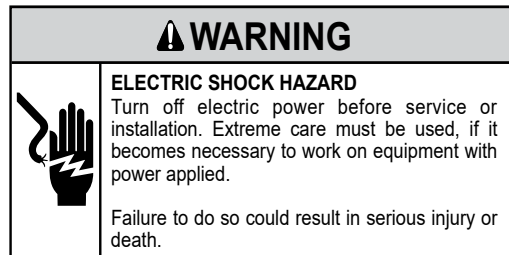

Figure 707 (Electronic Control Board Identification)

COMPONENTS TESTING

Replace the Electronic Control Board



1. Unplug the unit
2. Remove the Front Cover (refer to Routine Maintenance, Figure 401)
3. Remove the unit from the sleeve.(Refer to Figure 502)
4. Remove the discharge sensor (take note of the routing for reinstallation).
5. If necessary, cut wire ties and remove one (1) screw electronic holder to create slack in wiring.
6. Remove the four (4) circuit Board pins using needle nose pliers or other suitable tool.
7. Install the control board using four(4) new circuit board pins.
8. Reinstall the control board panel, secure wiring as required.
9. Install the Front Cover (refer to Routine Maintenance, Figure 401)
10. Plug in the unit and test the unit for proper operation. Refer to operation section.

Replace the User Interface

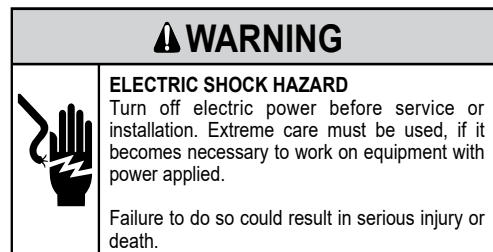

1. Unplug the Unit
2. Remove the Front Cover. (Refer to Routine Maintenance, Figure 401)
3. Remove the 4 corner screws from the rear of the user interface.
4. Inspect ribbon cable for obvious signs of damage.
5. If ribbon cable is damaged, or damage is suspected, disconnect cable from User Interface and Control Board.
6. Paying careful attention to the ribbon cable routing, remove the old cable and replace with a new ribbon cable.
7. Connect ribbon cable to the power board and user interface as required.
8. Install new UI using the 4 screws.
9. Plug in the unit and verify control operation.(Refer to Operation Section)

R-410A SEALED SYSTEM REPAIR

⚠ WARNING	
	Refrigeration system under high pressure Do not puncture, heat, expose to flame or incinerate. Only certified refrigeration technicians should service this equipment. R410A systems operate at higher pressures than R22 equipment. Appropriate safe service and handling practices must be used. Only use gauge sets designed for use with R410A. Do not use standard R22 gauge sets.

The following is a list of important considerations when working with R-410A equipment

1. R-410A pressure is approximately 60% higher than R-22 pressure.
2. R-410A cylinders must not be allowed to exceed 125 F, they may leak or rupture.
3. R-410A must never be pressurized with a mixture of air, it may become flammable.
4. Servicing equipment and components must be specifically designed for use with R-410A and dedicated to prevent contamination.
5. Manifold sets must be equipped with gauges capable of reading 750 psig (high side) and 200 psig (low side), with a 500-psig low-side retard.
6. Gauge hoses must have a minimum 750-psig service pressure rating
7. Recovery cylinders must have a minimum service pressure rating of 400 psig, (DOT 4BA400 and DOT BW400 approved cylinders).
8. POE (Polyol-Ester) lubricants must be used with R-410A equipment.
9. To prevent moisture absorption and lubricant contamination, do not leave the refrigeration system open to the atmosphere.
10. Weigh-in the refrigerant charge into the high side of the system.
11. Introduce liquid refrigerant charge into the high side of the system.
12. For low side pressure charging of R-410A, use a charging adaptor.
13. Use Friedrich approved R-410A filter dryers only.

IMPORTANT

SEALED SYSTEM REPAIRS TO COOL-ONLY MODELS REQUIRE THE INSTALLATION OF A LIQUID LINE DRIER.

EQUIPMENT REQUIRED:

1. Voltmeter
2. Ammeter
3. Ohmmeter
4. E.P.A. Approved Refrigerant Recovery System
5. Vacuum Pump (capable of 200 microns or less vacuum.)
6. Acetylene Torch.
7. Electronic Halogen Leak Detector capable of detecting HFC (Hydrofluorocarbon) refrigerants.
8. Digital refrigerant scale
9. High Pressure Gauge - (0 to 750 lbs.)
10. Low Pressure Gauge - (-30 to 200 lbs.)
11. Vacuum Gauge capable of reading 300 microns accurately.)
12. Facilities for flowing nitrogen through refrigeration tubing during all brazing processes.

EQUIPMENT MUST BE CAPABLE OF:

1. Recovering refrigerant to EPA required levels.
2. Evacuation from both the high side and low side of the system simultaneously.
3. Introducing refrigerant charge into high side of the system.
4. Accurately weighing the refrigerant charge introduced into the system.

R-410A SEALED SYSTEM REPAIRS

Refrigerant Charging

⚠ WARNING	
	HIGH PRESSURE HAZARD Sealed Refrigeration System contains refrigerant and oil under high pressure.
	Proper safety procedures must be followed, and proper protective clothing must be worn when working with refrigerants.
	Failure to follow these procedures could result in serious injury or death.

⚠ WARNING	
	RISK OF ELECTRIC SHOCK Unplug and/or disconnect all electrical power to the unit before performing inspections, maintenances or service.
	Failure to do so could result in electric shock, serious injury or death.

NOTE: Always weigh in refrigerant based on the model nameplate.

NOTE: Because the refrigerant system is a sealed system, service process tubes will have to be installed. First install a line tap and remove refrigerant from system. Make necessary sealed system repairs and vacuum system. Crimp process tube line and solder end shut. Do not leave a service valve in the sealed system.

Proper refrigerant charge is essential to proper unit operation. Operating a unit with an improper refrigerant charge will result in reduced performance (capacity) and/or efficiency. Accordingly, the use of proper charging methods during servicing will insure that the unit is functioning as designed and that its compressor will not be damaged.

NOTE: Factory sealed units will not be overcharged

Too much refrigerant (overcharge) in the system is just as bad (if not worse) than not enough refrigerant (undercharge). they both can be the source of certain compressor failures if they remain uncorrected for any period of time. Quite often, other problems (such as low air flow across evaporator, etc.) are misdiagnosed as refrigerant charge problems. The refrigerant circuit diagnosis chart will assist you in properly diagnosing the systems.

An overcharged unit will return liquid refrigerant (slugging) back to the suction side of the compressor eventually causing a mechanical failure within the compressor. This mechanical failure can manifest itself as valve failure, bearing failure, and/or other mechanical failure. The specific type of failure will be influenced by the amount of liquid being returned, and the length of time the slugging continues.

Not enough refrigerant (undercharge) on the other hand, will cause the temperature of the suction gas to increase to the point where it does not provide sufficient cooling for the compressor motor. When this occurs, the motor winding temperature will increase causing the motor to overheat and possibly cycle open the compressor overload protector. Continued overheating of the motor windings and/or cycling of the overload will eventually lead to compressor motor or overload failure.

R-410A SEALED SYSTEM REPAIRS

Undercharged Refrigerant Systems

NOTE: Ensure fan is on high speed during testing.

⚠ WARNING	
	<p>HIGH PRESSURE HAZARD</p> <p>Sealed Refrigeration System contains refrigerant and oil under high pressure.</p>
	<p>Proper safety procedures must be followed, and proper protective clothing must be worn when working with refrigerants.</p>
	<p>Failure to follow these procedures could result in serious injury or death.</p>

An undercharged system will result in poor performance (low pressures, etc.) in both the heating and cooling cycle.

Whenever you service a unit with an undercharge of refrigerant, always suspect a leak. The leak must be repaired before charging the unit.

To check for an undercharged system, turn the unit on, allow the compressor to run long enough to establish working pressures in the system (15 to 20 minutes).

During the cooling cycle you can listen carefully at the exit of the metering device into the evaporator; an intermittent hissing and gurgling sound indicates a low refrigerant charge. Intermittent frosting and thawing of the evaporator is another indication of a low charge, however, frosting and thawing can also be caused by insufficient air over the evaporator.

⚠ WARNING	
	<p>RISK OF ELECTRIC SHOCK</p> <p>Unplug and/or disconnect all electrical power to the unit before performing inspections, maintenances or service.</p>
	<p>Failure to do so could result in electric shock, serious injury or death.</p>

Checks for an undercharged system can be made at the compressor. If the compressor seems quieter than normal, it is an indication of a low refrigerant charge.

If the compressor reads low amperage and has a high discharge line temperature at the compressor, it is an indication of low system refrigerant.

A check of the amperage drawn by the compressor motor should show a lower reading. (Check the Unit Specification.) After the unit has run 10 to 15 minutes, check the gauge pressures. Gauges connected to system with an undercharge will have low head pressures and substantially low suction pressures.

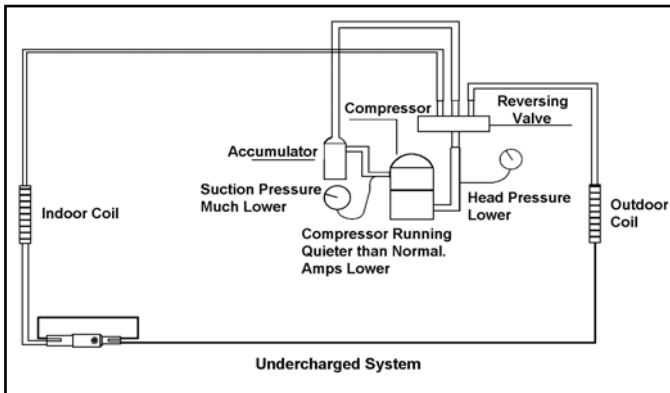



Figure 601 (Undercharged System)

R-410A SEALED SYSTEM REPAIRS

Overcharged Refrigerant Systems

NOTE: Units that have not been charged since factory will not have an overcharge.

NOTE: Ensure fan is on high speed during testing.

⚠ WARNING	
	<p>RISK OF ELECTRIC SHOCK</p> <p>Unplug and/or disconnect all electrical power to the unit before performing inspections, maintenances or service.</p>
	<p>Failure to do so could result in electric shock, serious injury or death.</p>

Compressor amps will be near normal or higher. Noncondensables can also cause these symptoms. To confirm, remove some of the charge, if conditions improve, system may be overcharged. If conditions don't improve, noncondensables are indicated.

NOTE: Factory sealed units will not be overcharged

Whenever an overcharged system is indicated, always make sure that the problem is not caused by air flow problems. Improper air flow over the evaporator coil may indicate some of the same symptoms as an overcharged system.

⚠ WARNING	
	<p>HIGH PRESSURE HAZARD</p> <p>Sealed Refrigeration System contains refrigerant and oil under high pressure.</p>
	<p>Proper safety procedures must be followed, and proper protective clothing must be worn when working with refrigerants.</p>
	<p>Failure to follow these procedures could result in serious injury or death.</p>

An overcharge can cause the compressor to fail, since it would be "slugged" with liquid refrigerant. The charge for any system is critical. When the compressor is noisy, suspect an overcharge, when you are sure that the air quantity over the evaporator coil is correct. Icing of the evaporator will not be encountered because the refrigerant will boil later if at all. Gauges connected to system will usually have higher head pressure (depending upon amount of over charge). Suction pressure should be slightly higher.

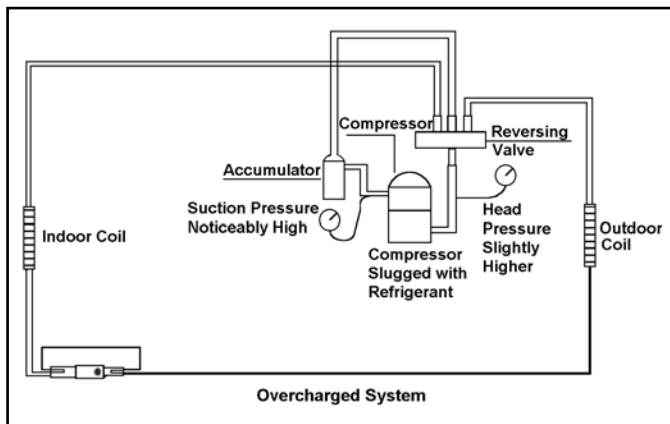

Figure 602 (Overcharged System)

R-410A SEALED SYSTEM REPAIRS

Restricted Refrigerant System

NOTE: Ensure fan is on high speed during testing.

Troubleshooting a restricted refrigerant system can be difficult. The following procedures are the more common problems and solutions to these problems. There are two types of refrigerant restrictions: Partial restrictions and complete restrictions.

A partial restriction allows some of the refrigerant to circulate through the system.

With a complete restriction there is no circulation of refrigerant in the system. Restricted refrigerant systems display the same symptoms as a "low-charge condition."

A quick check for either condition begins at the evaporator. With a partial restriction, there may be gurgling sounds at the metering device entrance to the evaporator. The evaporator in a partial restriction could be partially frosted or have an ice ball close to the entrance of the metering device. Frost may continue on the suction line back to the compressor.

Often a partial restriction of any type can be found by feel, as there is a temperature difference from one side of the restriction to the other. There will usually be a difference felt at the capillary tube. This does not indicate a restricted condition.

With a complete restriction, there will be no sound at the metering device entrance. An amperage check of the compressor with a partial restriction may show normal current when compared to the unit specification. With a complete restriction the current drawn may be considerably less than normal, as the compressor is running in a deep vacuum (no load.) Much of the area of the condenser will be relatively cool since most or all of the liquid refrigerant will be stored there.

Make all checks possible before tapping into the system and installing gauges.

When the unit is shut off, or the compressor disengages, the gauges may equalize very slowly.

The following conditions are based primarily on a system in the cooling mode.

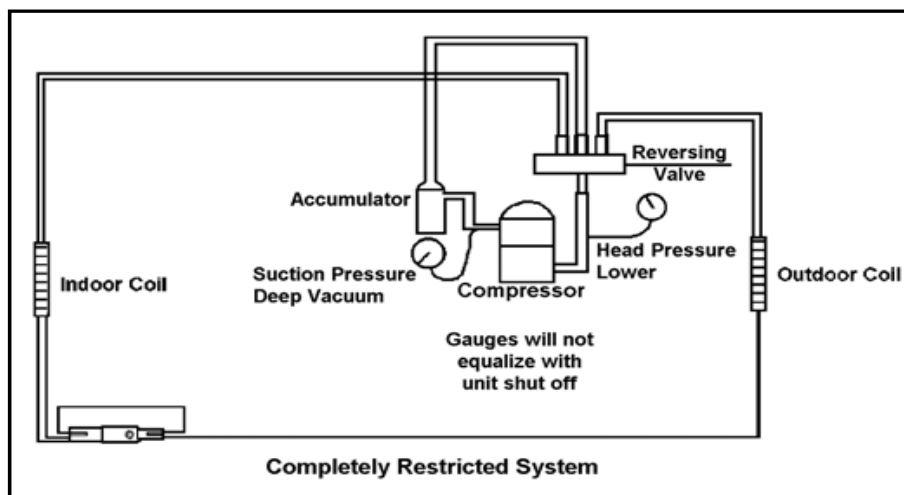



Figure 603 (Restricted System)

R-410A SEALED SYSTEM REPAIRS

Sealed System Method of Charging/ Repairs

⚠ WARNING	
	BURN HAZARD Proper safety procedures must be followed, and proper protective clothing must be worn when working with a torch. Failure to follow these procedures could result in moderate or serious injury.

⚠ CAUTION	
	FREEZE HAZARD Proper safety procedures must be followed, and proper protective clothing must be worn when working with liquid refrigerant. Failure to follow these procedures could result in minor to moderate injury.

The acceptable method for charging the sealed system is the Weighed in Charge Method. The weighed in charge method is applicable to all units. It is the preferred method to use, as it is the most accurate.

The weighed in method should always be used whenever a charge is removed from a unit such as for a leak repair, compressor replacement, or when there is no refrigerant charge left in the unit. To charge by this method, requires the following steps:

1. Install a piercing valve to remove refrigerant from the sealed system. (Piercing valve must be removed from the system before recharging.)
2. Recover Refrigerant in accordance with EPA regulations.
3. Install a process tube to sealed system.
4. Make necessary repairs to system.
5. Evacuate the system to 1500 microns
6. Repressurize to 50 PSI with nitrogen
7. Evacuate the system to 1000 microns
8. Repressurize to 50 PSI with nitrogen
9. Evacuate the system to below 500 microns
10. Weigh in the refrigerant charge with the property quantity of R-410A refrigerant per model nameplate.
11. Start unit, and verify performance.
12. Crimp the process tube and solder the end shut.

R-410A SEALED SYSTEM REPAIRS

Compressor Replacement

⚠ WARNING	
	<p>ELECTRIC SHOCK HAZARD Turn off electric power before service or installation. Extreme care must be used, if it becomes necessary to work on equipment with power applied.</p> <p>Failure to do so could result in serious injury or death.</p>

⚠ WARNING	
	<p>HIGH PRESSURE HAZARD Sealed Refrigeration System contains refrigerant and oil under high pressure.</p> <p>Proper safety procedures must be followed, and proper protective clothing must be worn when working with refrigerants.</p> <p>Failure to follow these procedures could result in serious injury or death.</p>

⚠ WARNING	
	<p>EXPLOSION HAZARD The use of nitrogen requires a pressure regulator. Follow all safety procedures and wear protective safety clothing etc.</p> <p>Failure to follow proper safety procedures could result in serious injury or death.</p>

⚠ CAUTION	
	<p>FREEZE HAZARD Proper safety procedures must be followed, and proper protective clothing must be worn when working with liquid refrigerant.</p> <p>Failure to follow these procedures could result in minor to moderate injury.</p>

⚠ WARNING	
	<p>NEVER, under any circumstances, liquid charge a rotary-compressor through the LOW side. Doing so would cause permanent damage to the new compressor. Use a charging adapter.</p>

1. Be certain to perform all necessary electrical and refrigeration tests to be sure the compressor is actually defective before replacing.
2. Recover all refrigerant from the system through the process tubes. **PROPER HANDLING OF RECOVERED REFRIGERANT ACCORDING TO EPA REGULATIONS IS REQUIRED.** Do not use gauge manifold for this purpose if there has been a burnout. You will contaminate your manifold and hoses. Use a Schrader valve adapter and copper tubing for burnout failures.
3. After all refrigerant has been recovered, disconnect suction and discharge lines from the compressor and remove compressor. Be certain to have both suction and discharge process tubes open to atmosphere.
4. Carefully pour a small amount of oil from the suction stub of the defective compressor into a clean container.
5. Using an acid test kit (one shot or conventional kit), test the oil for acid content according to the instructions with the kit.
6. If any evidence of a burnout is found, no matter how slight, the system will need to be cleaned up following proper procedures.
7. Install the replacement compressor.

CAUTION: While the unit is being evacuated, seal all openings on the defective compressor. Compressor manufacturers will void warranties on units received not properly sealed. Do not distort the manufacturers tube connections.

8. Pressurize with trace amounts of R-410A and nitrogen and leak test all connections with a leak detector. Repair any leaks found.
 - 8a. If leak detector is unavailable remove all refrigerant from system and pressurize with nitrogen to 550 psi. Check that system holds pressure. Repeat Step 8 to ensure no more leaks are present
9. Evacuate the system with a good vacuum pump capable of a final vacuum of 200 microns or less. The system should be evacuated through both liquid line and suction line gauge ports.
 - 9a. Evacuate the system to 1500 microns.
 - 9b. Repressurize to 50 PSI with nitrogen.
 - 9c. Evacuate the system to 1000 microns.
 - 9d. Repressurize to 50 PSI with nitrogen.
 - 9e. Evacuate the system to below 500 microns.
10. Weigh in the refrigerant charge with the property quantity of R-410A refrigerant per model nameplate.
11. Start unit, and verify performance.
12. Crimp the process tube and solder the end shut.

R-410A SEALED SYSTEM REPAIRS

Compressor Replacement -Special Procedure in Case of Compressor Burnout

⚠ WARNING	
	HIGH PRESSURE HAZARD Sealed Refrigeration System contains refrigerant and oil under high pressure.
	Proper safety procedures must be followed, and proper protective clothing must be worn when working with refrigerants.
	Failure to follow these procedures could result in serious injury or death.

⚠ WARNING	
	EXPLOSION HAZARD The use of nitrogen requires a pressure regulator. Follow all safety procedures and wear protective safety clothing etc.
	Failure to follow proper safety procedures could result in serious injury or death.

⚠ WARNING	
	ELECTRIC SHOCK HAZARD Turn off electric power before service or installation. Extreme care must be used, if it becomes necessary to work on equipment with power applied.
	Failure to do so could result in serious injury or death.

⚠ WARNING	
	NEVER, under any circumstances, liquid charge a rotary-compressor through the LOW side. Doing so would cause permanent damage to the new compressor. Use a charging adapter.

1. Recover all refrigerant and oil from the system.
2. Remove compressor, capillary tube and filter drier from the system.
3. Flush evaporator condenser and all connecting tubing with dry nitrogen or equivalent. Use approved flushing agent to remove all contamination from system. Inspect suction and discharge line for carbon deposits. Remove and clean if necessary. Ensure all acid is neutralized.
4. Reassemble the system, including new drier strainer and capillary tube.

5. Pressurize with trace amounts of R-410A and nitrogen and leak test all connections with a leak detector. Repair any leaks found.
- 5a. If leak detector is unavailable remove all refrigerant from system and pressurize with nitrogen to 550 psi. Check that system holds pressure.

Repeat Step 5 to insure no more leaks are present.

NOTE: While the unit is being evacuated, seal all openings on the defective compressor. Compressor manufacturers will void warranties on units received not properly sealed. Do not distort the manufacturers tube connections.

9. Evacuate the system with a good vacuum pump capable of a final vacuum of 200 microns or less. The system should be evacuated through both liquid line and suction line gauge ports.
 - 9a. Evacuate the system to 1500 microns.
 - 9b. Repressurize to 50 PSI with nitrogen.
 - 9c. Evacuate the system to 1000 microns.
 - 9d. Repressurize to 50 PSI with nitrogen.
 - 9e. Evacuate the system to below 500 microns.

7. Recharge the system with the correct amount of refrigerant. The proper refrigerant charge will be found on the unit rating plate. The use of an accurate measuring device, such as a charging cylinder, electronic scales or similar device is necessary.

WIRING DIAGRAMS

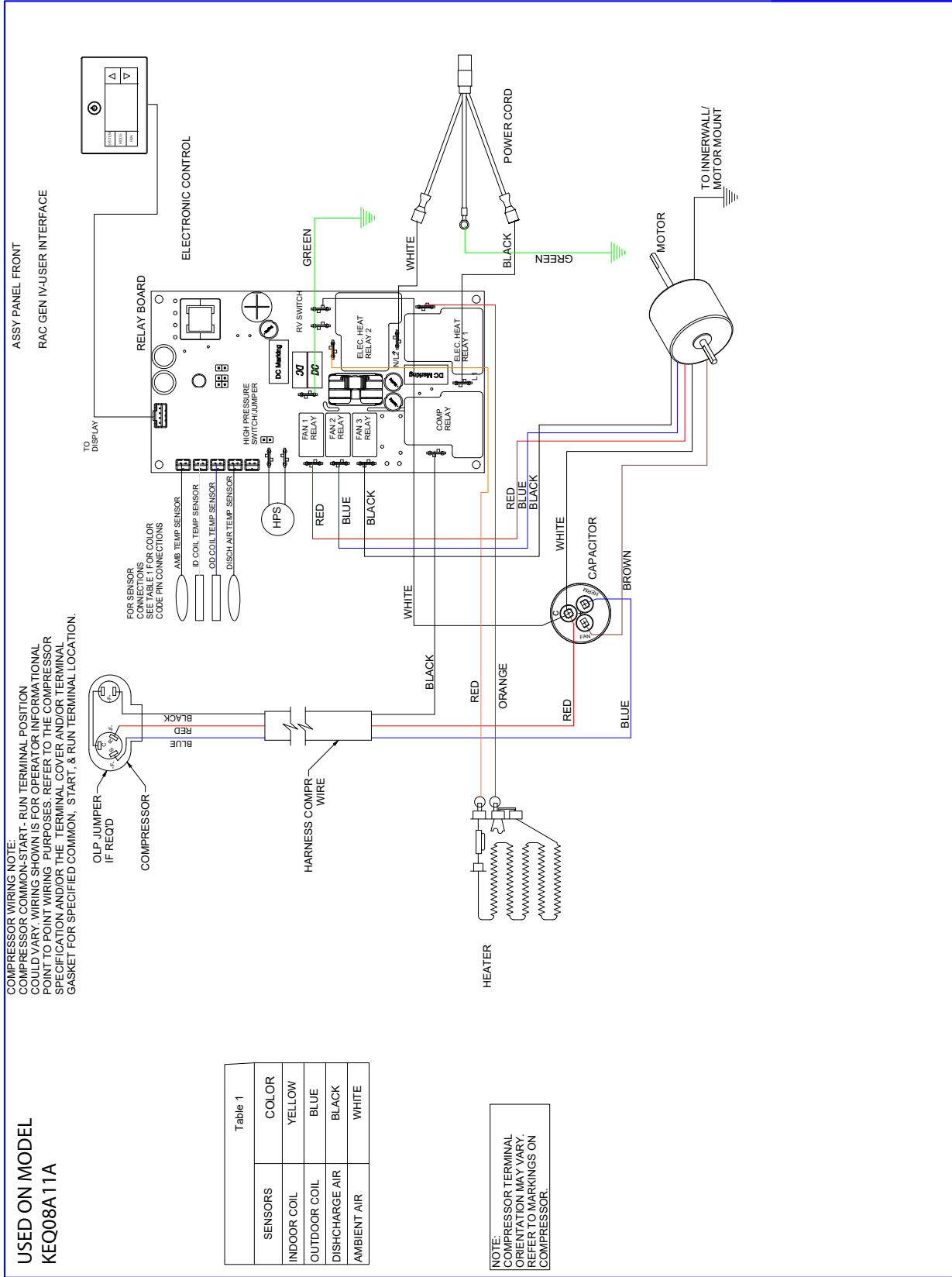

Figure 801 (Wiring Diagrams)

WIRING DIAGRAMS

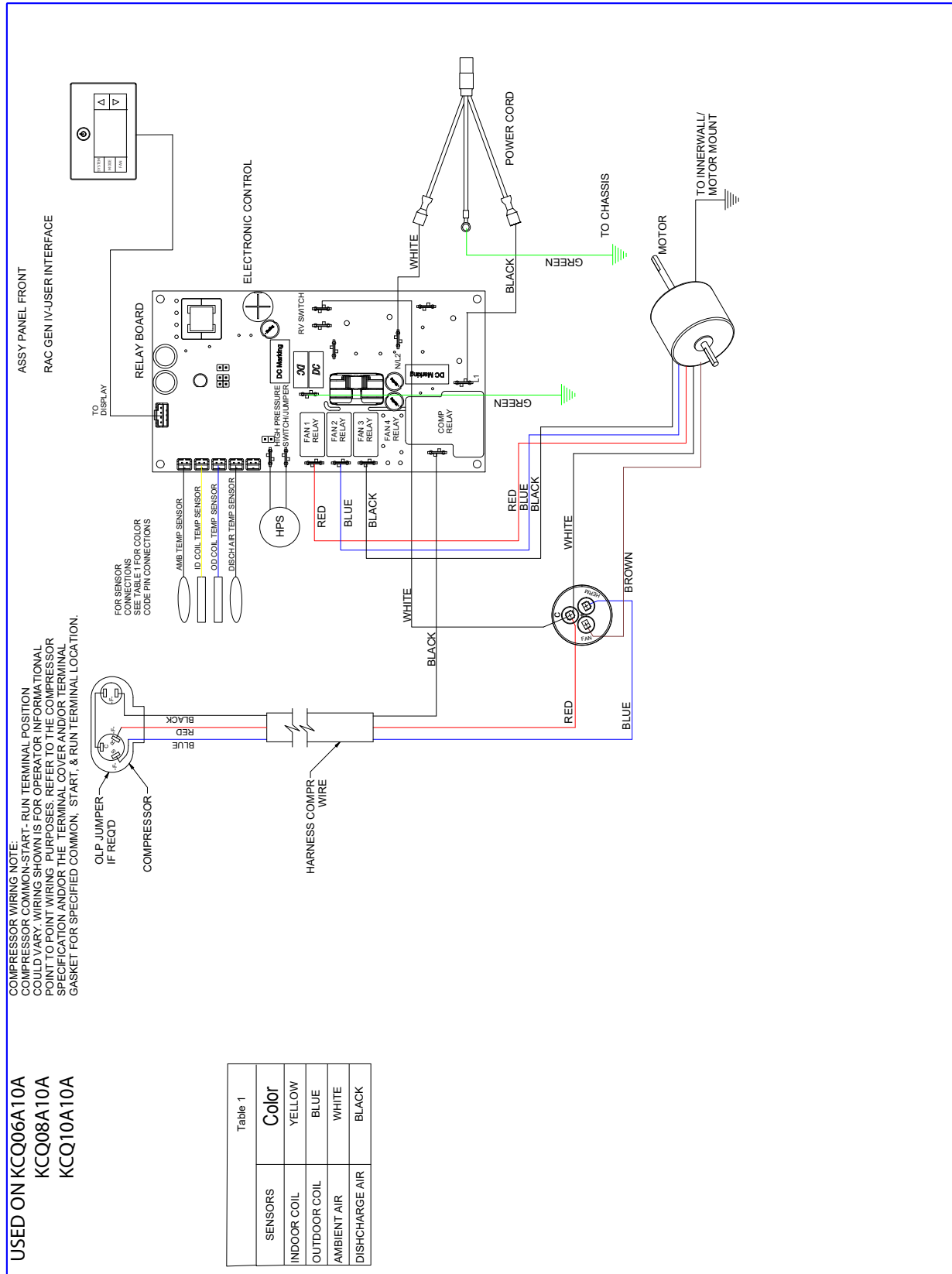

Figure 802 (Wiring Diagrams)

AVAILABLE ACCESSORIES

Premium Carbon Filters

Remove odors and VOCs (volatile organic compounds). Achieve up to a MERV 6 rating when used with standard filter. 3 pack



Model	Kit No.
KCQ and KEQ	KWCFQ

Drain Kit

Allows field installed drain tube to be installed to the bottom of the sleeve to route the condensate from the unit.



Model	Kit No.
All Kühl Series Models	DC2

Window Mounting Kits: Kühl+

Window kits are included with cooling only models, but are an accessory item for Kühl+ heat/cool models. Window kits are required for installation of Kühl+ models in a window.

Heat/Cool Models	Kit No.
KEQ08A11A*	KWIKQA

* KEQ08A11A window kit KWIKQA does not include window brackets.



KWIKQA



KWIKSB, KWIKMB, KWIKLB

APPENDIX

Thermistor Resistance Values (This Table Applies to All Thermistors)

TEMP	RESISTENCE (K Ohms)			RESISTANCE TOLERANCE %	
	MIN	CENTR	MAX	MIN	MAX
F					
-25	210.889	225.548	240.224	6.50	6.51
-20	178.952	190.889	202.825	6.25	6.25
-15	151.591	161.325	171.059	6.03	6.03
-10	128.434	136.363	144.292	5.81	5.81
-5	108.886	115.340	121.794	5.60	5.60
0	92.411	97.662	102.912	5.38	5.38
5	78.541	82.812	87.083	5.16	5.16
10	66.866	70.339	73.812	4.94	4.94
15	57.039	59.864	62.688	4.72	4.72
20	48.763	51.060	53.357	4.50	4.50
25	41.786	43.654	45.523	4.28	4.28
30	35.896	37.415	38.934	4.06	4.06
31	34.832	36.290	37.747	4.02	4.02
32	33.803	35.202	36.601	3.97	3.97
33	32.808	34.150	35.492	3.93	3.93
34	31.846	33.133	34.421	3.89	3.89
35	30.916	32.151	33.386	3.84	3.84
36	30.016	31.200	32.385	3.80	3.80
37	29.144	30.281	31.418	3.75	3.75
38	28.319	29.425	30.534	3.76	3.77
39	27.486	28.532	29.579	3.67	3.67
40	26.697	27.701	28.704	3.62	3.62
45	23.116	23.931	24.745	3.40	3.40
50	20.071	20.731	21.391	3.18	3.18
55	17.474	18.008	18.542	2.96	2.96
60	15.253	15.684	16.115	2.75	2.75
65	13.351	13.697	14.043	2.53	2.53
66	13.004	13.335	13.666	2.48	2.48
67	12.668	12.984	13.301	2.44	2.44
68	12.341	12.644	12.947	2.39	2.39
69	12.024	12.313	12.603	2.35	2.35
70	11.716	11.993	12.269	2.31	2.31
71	11.418	11.682	11.946	2.26	2.26
72	11.128	11.380	11.633	2.22	2.22
73	10.846	11.088	11.329	2.18	2.18
74	10.574	10.804	11.034	2.13	2.13
75	10.308	10.528	10.748	2.09	2.09
76	10.051	10.260	10.469	2.04	2.04
77	9.800	10.000	10.200	2.00	2.00
78	9.550	9.748	9.945	2.03	2.03
79	9.306	9.503	9.699	2.07	2.07
80	9.070	9.265	9.459	2.10	2.10
81	8.841	9.033	9.226	2.13	2.13
82	8.618	8.809	9.000	2.17	2.17
83	8.402	8.591	8.780	2.20	2.20
84	8.192	8.379	8.566	2.23	2.23
85	7.987	8.172	8.358	2.27	2.27
86	7.789	7.972	8.155	2.30	2.30
87	7.596	7.778	7.959	2.33	2.33
88	7.409	7.589	7.768	2.37	2.37
89	7.227	7.405	7.583	2.40	2.40
90	7.050	7.226	7.402	2.43	2.43
91	6.878	7.052	7.226	2.47	2.47
92	6.711	6.883	7.055	2.50	2.50
93	6.548	6.718	6.889	2.53	2.53
94	6.390	6.558	6.727	2.57	2.57
95	6.237	6.403	6.569	2.60	2.60
96	6.087	6.252	6.417	2.63	2.63
97	5.942	6.105	6.268	2.67	2.67
98	5.800	5.961	6.122	2.70	2.70
99	5.663	5.822	5.981	2.73	2.73
100	5.529	5.686	5.844	2.77	2.77
105	4.912	5.060	5.208	2.93	2.93
110	4.371	4.511	4.651	3.10	3.10
115	3.898	4.030	4.161	3.27	3.27
120	3.482	3.606	3.730	3.43	3.43

Figure 706 Thermistor Values

APPENDIX

Interactive Parts Viewer

All Friedrich Service Parts can be found on our online interactive parts viewer.

Please click on the link below:

[Interactive Parts Viewer](#)

For Further Assistance contact Friedrich customer service at **(1-800-541-6645)**.

Limited Warranty

Current warranty information can be obtained by referring to <https://www.friedrich.com/professional/support/product-resources>

APPENDIX

Friedrich Authorized Parts Depots

NEUCO Inc.

515 W Crossroads Parkway
Bolingbrook, IL 60440
312.809.1418
borr@neuco.com

United Products Distributors Inc.

4030A Benson Ave
Halethorpe, MD 21227
888-907-9675
c.businsky@updinc.com

Shivani Refrigeration & Air Conditioning Inc.

2259 Westchester Ave.
Bronx, NY 10462
sales@shivanionline.com

The Gabbert Company

6868 Ardmore
Houston, Texas 77054

713-747-4110
800-458-4110

Johnstone Supply of Woodside

27-01 Brooklyn Queens Expway
Woodside, New York 11377

718-545-5464
800-431-1143

Reeve Air Conditioning, Inc.

2501 South Park Road
Hallandale, Florida 33009

954-962-0252
800-962-3383

Total Home Supply

26 Chapin Rd Ste 1109
Pine Brook, NJ 07058
877-847-0050

support@totalhomesupply.com
<https://www.totalhomesupply.com/brands/Friedrich.html>



FRIEDRICH

TECHNICAL SUPPORT CONTACT INFORMATION

Friedrich Air Conditioning Co.
10001 Reunion Place, Suite 500 • San Antonio, Texas 78216
1-800-541-6645

www.friedrich.com