













Operating and Installation Instructions Refrigerators



To prevent accidents and machine damage, read these instructions **before** installation or use.

Contents

IMPORTANT SAFETY INSTRUCTIONS	5
Caring for the environment	14
Installation	15
Installation location	15
Climate class	15
Installation notes	16
Adjoining cabinetry/units.....	16
Load-bearing capacity of the niche floor	17
Ventilation.....	17
Door hinge.....	17
Side-by-side	18
Installation dimensions.....	20
Position of the electrical connection	20
Dimensions when the appliance door is open (opening angle 90°/115°).....	23
Building in the appliance	24
Before starting.....	24
Tools required	24
Aligning the installation niche.....	25
Checking the installation niche	25
Before installation.....	26
Preparing the installation niche	27
Pushing the appliance into the niche	29
Aligning the refrigeration appliance.....	31
Securing the appliance in the niche	33
Securing the toe-kick board and cover.....	34
Aligning the appliance door.....	34
Limiting the opening angle of the appliance door.....	37
Electrical connection	38
Saving energy	40
Guide to the appliance	42
Main screen	44
Settings mode 	45
Accessories	47
Accessories supplied	47
Optional accessories.....	47

Before first use	48
Choosing the right Door Assistant (Push2Open/Pull2Open)	48
Inserting the Active AirClean filters	49
Miele@home	49
Operating the refrigeration appliance.....	50
Starting up for the first time	50
Switching on and off	52
Switching off for longer periods of time	53
Selecting additional settings	54
Switching Keypad Lock  /  on or off	54
Adjusting the temperature in the MasterFresh zone (dry compartment) 	55
Switching Eco Mode  on or off	55
Performing a Self Test 	56
Switching on the Door Assistant 	57
Switching off the Door Assistant 	59
Miele@home	59
Switching off Demo Mode 	61
Resetting the settings to their default settings 	62
Switching Sabbath Mode  on or off	64
Switching on, switching off, or resetting the Display Active AirClean Filter 	65
The correct temperature	67
... in the refrigerator section and in the MasterFresh zone	67
Automatic cold air circulation (DynaCool)	67
Setting the temperature.....	68
Adjusting the temperature in the dry compartment of the MasterFresh zone	68
Temperature range	68
Using Automatic SuperCool	69
Door alarm	70
Adjusting the interior fittings	71
Removing or moving the door shelves.....	71
Removing or moving the shelves	71
Removing the hanging drawer	72
Removing compartments from the Fridge Zone	73
Storing food in the refrigerator section	74
Different storage zones	74
Food which is not suitable for storage in the fridge zone	75
Notes on buying food.....	76
Storing food correctly.....	76

Contents

Storing food in the MasterFresh zone	77
MasterFresh zone.....	77
Humidity-controlled compartment with moisture adjustment.....	77
Dry compartment with adjustable temperature.....	79
Automatic defrosting	81
Cleaning and care	82
Cleaning agents.....	82
Before cleaning the appliance.....	83
Interior and accessories	83
Cleaning the door seal	84
Cleaning the ventilation gaps	84
Replacing the Active AirClean filters	85
Frequently Asked Questions	86
Causes of noises	91
Customer Service	92
Contact in the event of a fault	92
Appliance warranty and product registration	92
Declaration of conformity	93
Copyrights and licenses	94

IMPORTANT SAFETY INSTRUCTIONS

This refrigeration appliance complies with current safety requirements. Inappropriate use can, however, lead to personal injury and material damage.

Please read the operating and installation instructions carefully before using the refrigeration appliance for the first time. They contain important information on safety, installation, use, and maintenance. This is to protect yourself from injury, and from damaging your refrigeration appliance.

In accordance with standard IEC 60335-1, Miele expressly and strongly advises that you read and follow the instructions in the chapter on installing the refrigeration appliance as well as in the "IMPORTANT SAFETY INSTRUCTIONS".

Miele cannot be held liable for injury or damage caused by non-compliance with these instructions.

Keep these instructions in a safe place and pass them on to any future owner.

 Risk of injury and damage due to tipping refrigeration appliance.

This refrigeration appliance is very heavy and can tip forward when the door is open.

Keep the appliance door shut until the refrigeration appliance has been built in and secured in its housing in accordance with the operating and installation instructions.

IMPORTANT SAFETY INSTRUCTIONS

Appropriate use

- ▶ This appliance is intended for use in domestic households and similar residential environments such as
 - staff kitchen areas in shops, offices and other working environments
 - farm houses and by clients in hotels, motels and other residential type environments
 - bed and breakfast type environments
 - catering and similar non-retail applications.

This appliance is not intended for use outdoors, in damp environments or in places exposed to rain.

- ▶ This refrigeration appliance is intended for domestic use only for the cool storage of food and drink.

Any other usage is at the owner's risk and could be dangerous.

- ▶ This refrigeration appliance is not suitable for storing and keeping cool medicines, blood plasma, laboratory preparations, or other similar substances or products that are subject to the Medical Device Directive. Incorrect use of the refrigeration appliance for such purposes may cause deterioration of the items stored. The refrigeration appliance is also not suitable for use in areas where there is a risk of explosion.

Miele cannot be held liable for damage resulting from incorrect or improper use or operation.

- ▶ This refrigeration appliance may only be used by people (including children) with reduced physical, sensory, or mental capabilities or lack of experience and knowledge if they are supervised while using it.

The refrigeration appliance may only be used by these people without supervision if they have been shown how to use it in a safe way and recognize and understand the consequences of incorrect operation.

IMPORTANT SAFETY INSTRUCTIONS

Safety with children

- ▶ To reduce the risk of injury, do not allow children to play in, on or near the appliance.
- ▶ The door hinges can cause injury. Keep children well away at all times.
- ▶ Ensure that any packing material is disposed of safely and kept out of the reach of children. DANGER of suffocation!

Technical safety

- ▶ The coolant circuit has been checked for leaks. The refrigeration appliance complies with statutory and regulatory requirements.



- ▶ This refrigeration appliance contains the coolant Isobutane (R600a), a natural gas which is environmentally friendly. Although it is combustible, it does not damage the ozone layer and does not contribute to the greenhouse effect.

The use of this coolant has, however, led to a slight increase in the noise level of the appliance. In addition to the noise of the compressor, you might be able to hear the coolant flowing around the cooling circuit. Unfortunately, this cannot be avoided, but it does not affect the performance of the refrigeration appliance.

When transporting and installing the refrigeration appliance, ensure that no parts of the cooling circuit are damaged. Splashes of coolant can damage the eyes.

In the event of damage:

- Avoid open flames or anything which creates a spark.
- Disconnect the refrigeration appliance from the power supply.
- Ventilate the room where the refrigeration appliance is located for several minutes.

IMPORTANT SAFETY INSTRUCTIONS

- Contact Miele Customer Service.
- ▶ The more coolant there is in a refrigeration appliance, the larger the room it should be installed in. In the event of a leakage, if the appliance is in a small room, there is the danger of a combustible gas/air mixture building up. For every 11 g of coolant, at least 1 m³ of room space is required. The amount of coolant in the refrigeration appliance is stated on the data plate inside the appliance.
- ▶ To avoid the risk of damage to the appliance, make sure that the connection data (fuse rating, frequency and voltage) on the data plate corresponds to the household supply. Check that this is the case before connecting the appliance. Consult a qualified electrician if in any doubt.
- ▶ The electrical safety of the appliance can only be guaranteed when correctly grounded. It is essential that this standard safety requirement is met. If in any doubt please have the electrical installation tested by a qualified electrician.
- ▶ Reliable and safe operation of this appliance can only be assured if it has been connected to the electricity supply.
- ▶ The outlet must not be concealed behind the appliance and must be easily accessible so that the appliance can be quickly disconnected from the electrical supply in case of an emergency.
- ▶ If the power cord supplied is damaged, it must only be replaced by an original part to prevent a hazard for the user. Miele can only guarantee the safety of the appliance when original Miele parts are used.
- ▶ The electrical outlet must be properly grounded.
- ▶ Do not connect the appliance to the electrical supply with a power bar or extension cord. These are a fire hazard and do not guarantee the required safety of the appliance.

IMPORTANT SAFETY INSTRUCTIONS

- ▶ If moisture gets into electrical components or into the power cord, it could cause a short circuit. Therefore, do not operate the machine in areas where there may be moisture or splashing water (e.g., garages, laundry rooms).
- ▶ This appliance must not be installed and operated in mobile installations (e.g. on a ship).
- ▶ Do not use a damaged appliance. It could be dangerous. Check the appliance for visible signs of damage.
- ▶ For safety reasons, this appliance may only be used after it has been built in.
- ▶ During installation, side-by-side heater installation, maintenance and repair work, the appliance must be disconnected from the electrical power supply. It is only completely isolated from the electricity supply when:
 - the circuit breaker has been tripped, or
 - the screw-type fuses on the electrical service panel have been removed or
 - the power cord has been unplugged. Pull on the plug and not on the cord when removing it from the outlet.
- ▶ Installation, repair, and maintenance work should only be performed by a Miele-authorized service technician. Work by unqualified persons could be dangerous and may void the warranty.
- ▶ Any manufacturer's warranty will be void if the appliance is not repaired by a Miele approved service technician.
- ▶ Faulty components must only be replaced by genuine Miele replacement parts. Miele can only guarantee the safety standards of the appliance when Miele replacement parts are used.

IMPORTANT SAFETY INSTRUCTIONS

Correct use

- ▶ The refrigeration appliance is designed for use within a specific climate class (room temperature range). Do not use in a climate class for which it is not designed. A lower room temperature will cause the compressor to switch off for longer periods, meaning that the refrigeration appliance is unable to maintain the required temperature.
- ▶ **WARNING! DANGER of overheating!** Do not cover or block the air vents. This can impair the efficiency of the appliance, increase the power consumption and cause damage to the appliance.
- ▶ If storing food which contains a lot of fat or oil in the appliance, make sure that it does not come into contact with plastic components as this could cause stress cracks or break the plastic.
- ▶ Risk of fire and explosion. Do not store any explosive materials or products containing flammable propellants (e.g., spray cans) in the appliance. Electrical components can cause flammable mixes of gases to ignite.
- ▶ Risk of explosion. Do not operate any electrical equipment (e.g., an electric ice-cream maker) inside the refrigeration appliance. Risk of sparking and explosion.
- ▶ When eating stored food, there is a danger of food poisoning. Storage times will depend on several factors, including the freshness and quality of the food, as well as the temperature at which it is stored. Observe the manufacturer's "use-by" dates and storage instructions.
- ▶ Use only genuine original Miele parts. If parts or accessories from other manufacturers are used, the warranty may become invalid.

IMPORTANT SAFETY INSTRUCTIONS

Stainless steel machines:

- ▶ Adhesives will damage the coated stainless steel surface and cause it to lose its dirt-repellent protective coating. Do not use sticky notes, transparent adhesive tape, masking tape, or other types of adhesive on the stainless steel surface.
- ▶ The surface is easily scratched. Even magnets can cause scratching.

IMPORTANT SAFETY INSTRUCTIONS

Cleaning and maintenance

- ▶ Do not use any oil or grease on the door seals. They can cause the seals to deteriorate over time.
- ▶ Never use a steam cleaner to clean the appliance. The steam can reach the electrical components and cause a short circuit.
- ▶ Sharp edged or pointed objects will damage the evaporator, causing irreversible damage to the appliance. Do not use sharp edged or pointed objects to
 - remove frost or ice,
 - separate frozen foods or remove ice trays.

Transport

- ▶ To avoid damage to the appliance, always transport it upright and in its packaging.
- ▶ Risk of injury and damage. The refrigeration appliance is very heavy and must be transported by two people.

IMPORTANT SAFETY INSTRUCTIONS

Disposal of your old appliance

- ▶ Children could become trapped in the machine and could suffocate.
 - Remove the machine doors.
 - Remove the drawers.
 - Leave the adjustable shelves in the machine so children cannot climb inside.
- ▶ DANGER of electric shock!
 - Cut the plug off the power cord.
 - Cut the power cord off the old appliance.
- ▶ Dispose of them separately from the appliance.
- ▶ Ensure that the appliance is not stored in the vicinity of gasoline or inflammable gases and liquids during and after disposal.
- ▶ Make sure that the coolant pipework is not damaged during disposal to avoid uncontrolled leakage of oil and coolant (see data plate for coolant type).
- ▶ Splashes of coolant can cause damage to the eyes. Be careful not to damage any part of the pipework while awaiting disposal, e.g. by
 - puncturing the coolant channels in the evaporator,
 - kinking any pipework,
 - scratching the surface coating.

Caring for the environment

Disposal of packaging material

The packaging is designed to protect the appliance from damage during transportation. The packaging materials used are selected from materials which are environmentally friendly for disposal and should be recycled.

Ensure that any plastic wrappings, bags, etc. are disposed of safely and kept out of the reach of children. Return the packaging to your dealer.

Disposing of your old appliance

Electronic and electrical appliances contain many valuable materials. They also contain certain materials, compounds, and components which were essential for their correct functioning and safety. These could be hazardous to your health and to the environment if disposed of with general waste or if handled incorrectly. Please do not, therefore, dispose of your old appliance with general waste.

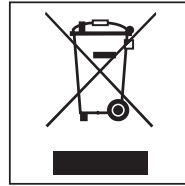

Instead, please make use of officially designated collection and disposal points to dispose of and recycle electrical and electronic appliances. By law, you are solely responsible for deleting any personal data from the appliance prior to disposal.

Take care not to damage your refrigeration appliance's pipework before or during transportation to an authorized collection depot.

This is to ensure that coolant in the cooling circuit and oil in the compressor is contained, and will not leak into the environment.

Please ensure that your old appliance poses no risk to children while being stored for disposal. For additional information, see "IMPORTANT SAFETY INSTRUCTIONS" in these operating and installation instructions.

Installation location

This appliance should be installed in a dry, well-ventilated room.

When deciding where to install your refrigeration appliance, please bear in mind that it will use more energy if installed near to a heater, a range, or another appliance that gives off heat. Direct sunlight should also be avoided. The higher the room temperature, the longer the compressor runs and the higher the energy consumption of the refrigeration appliance.

When installing the refrigeration appliance, please note the following:

- The electrical socket must be easily accessible in an emergency and not concealed behind the appliance.
- The plug and power cord must not touch the rear of the refrigeration appliance as they could be damaged by vibrations from the appliance.
- Do not plug in other appliances behind the refrigeration appliance.

If installation near a heat source is unavoidable, observe the following minimum distances between the appliance and the heat source:

- At least 1 1/4" (3 cm) to electric or gas stoves
- At least 11 3/4" (30 cm) to oil or coal-based stoves

If it is not possible to observe these minimum distances, an isolation plate must be installed between the refrigeration appliance and the heat source.

Climate class

The refrigeration appliance is designed for use within the climate class (room temperature range) SN-T. Do not use in a climate class for which it is not designed.

Climate class	Room temperature
SN	50°F to 90°F / 10°C to 32°C
N	60°F to 90°F / +16°C to +32°C
ST	60°F to 100°F / +16 to +38°C
T	60°F to 109°F / +16 to +43°C

A lower room temperature will cause the compressor to switch off for longer periods. This can cause the internal temperature in the refrigeration appliance to rise with the risk of food deteriorating and going off.

Installation

 Risk of damage due to high humidity.

In environments with high humidity, condensation can build up on external refrigeration appliance panels, which can cause corrosion.

Install the refrigeration appliance in a dry and/or air-conditioned room with sufficient ventilation.

After installation, make sure that the appliance door closes properly, the ventilation gaps are not covered, and that the refrigeration appliance has been installed in accordance with the operating and installation instructions.

Installation notes

 Risk of damage and injury due to the refrigeration appliance tipping over.

This refrigeration appliance is very heavy and can tip forwards when the appliance door(s) is (are) open.

Keep the appliance door(s) shut until the refrigeration appliance has been built in and secured in its housing in accordance with these operating and installation instructions.

Due to its weight and size, the refrigeration appliance must be installed by two people.

Adjoining cabinetry/units

The appliance is screwed to the adjoining cabinetry/units to the side and above. For this reason, it is essential that all cabinets/units are fixed to the ground and/or wall.

Load-bearing capacity of the niche floor

To ensure the safe installation of the refrigeration appliance and to guarantee its correct functioning, the floor of the niche where the appliance is to be installed must be smooth and even.

It must be made from strong, rigid material.

Because the refrigeration appliance is extremely heavy when fully loaded, it is essential that the floor it stands on is able to bear its weight. If necessary, seek the advice of an architect or construction expert.

When fully loaded, the weight of the refrigeration appliance is approx.:

K 2602 SF	776 lbs (352 kg)
K 2802 SF, K 2812 SF	899 lbs (408 kg)
K 2902 SF, K 2912 SF	1042 lbs (473 kg)

Ventilation

 Risk of fire and damage due to insufficient ventilation.

If the refrigeration appliance is not ventilated sufficiently, the compressor will run more frequently and for longer periods.

This causes increased energy consumption and an increased compressor operating temperature, which can result in damage to the compressor.

Please ensure that there is adequate ventilation around the refrigeration appliance.

Do not block the ventilation gaps.

The ventilation gaps must never be obstructed.

Door hinge

 Risk of damage and injury when changing the door hinges.

Changing the door hinges single-handedly can cause damage to the appliance and injury.

The refrigeration appliance is supplied with a fixed hinge. On no account should you attempt to change the door hinge yourself.

If you need to change the door hinge to the other side, please contact the Miele Service department.

Installation

Side-by-side

This appliance can be installed side-by-side with another refrigeration appliance. The following overview will show you which side-by-side options you have with your appliance:

A side-by-side merging kit and a top frame (KTF) are required for this. Both are available from your Miele dealer or Miele Service.

Instructions for installing appliances side-by-side can be found in the side-by-side merging kit instruction manual.

. . . with partition wall

The wall **a** between the side-by-side appliances must be **at least 5/8" (16 mm)** thick.

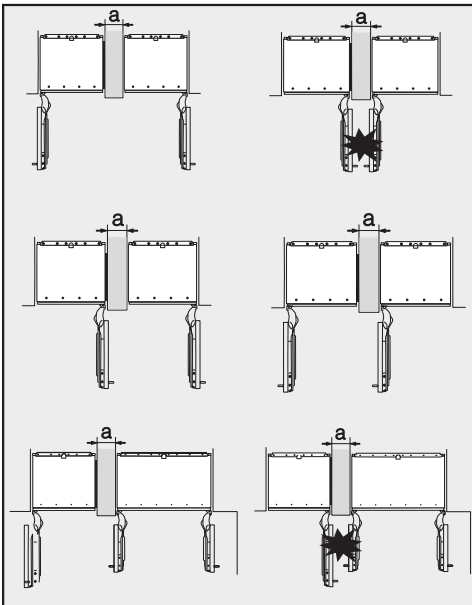

If the door hinges of the refrigeration appliances are next to each other, you must take into account the thickness of the cabinet fronts and door handles so that the appliance doors do not collide and become damaged if they are opened at the same time.

The refrigeration appliances are secured individually in their installation niche using the supplied installation material.

If the partition wall **a** is **narrower than 6 5/16" (160 mm)**, you will need the side panel heater from the side-by-side installation kit to prevent condensation from forming and any resulting damage.

When planning installation niches, please note that the niche into which the refrigeration appliance with the side panel heater is installed must be **3/16" (4 mm)** wider (see "Installation – Building-in dimensions").

If the partition wall **a** is **thicker than 6 5/16" (160 mm)**, you do not need the side-by-side installation kit, nor the side panel heater.

... without partition wall

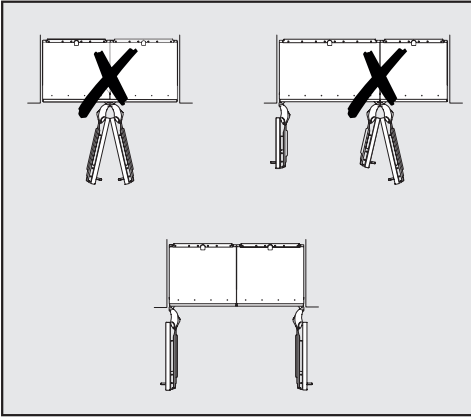

If the appliances are to be installed next to each other without a partition wall between them, they will need to be joined together with the side-by-side installation kit. In addition, you must install the side panel heater to prevent condensation from forming and any resulting damage.

Installation

Installation dimensions

Position of the electrical connection

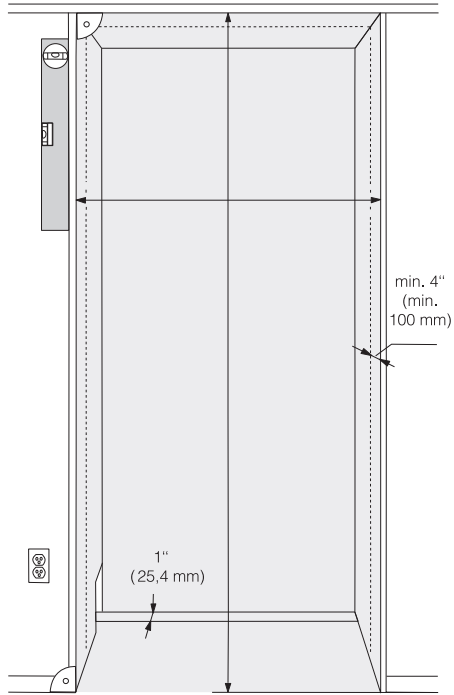

- The electrical connection must not be positioned higher than 9" (228 mm) above the floor.

The electrical socket must not be concealed behind the appliance and must be easily accessible in an emergency.

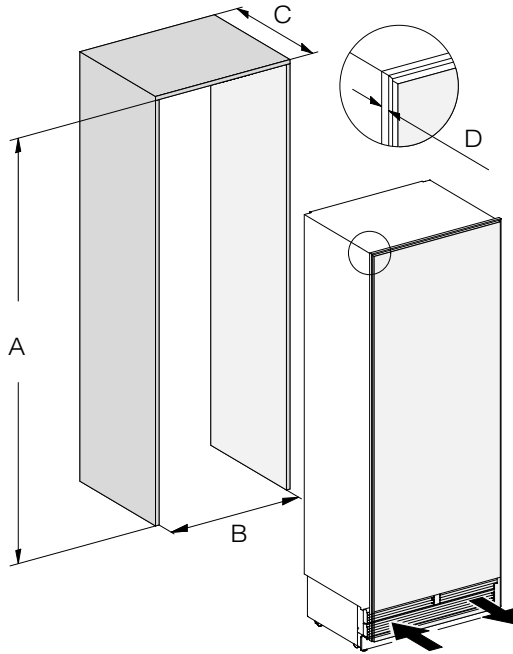

	A	B	C	D
K 2602 SF, K 2612 SF	84"-85 3/16" (2,134-2,164 mm)	24" (610 mm)	24" (610 mm)	3/4" (19 mm)
K 2802 SF, K 2812 SF	84"-85 3/16" (2,134-2,164 mm)	30" (762 mm)	24" (610 mm)	3/4" (19 mm)
K 2902 SF, K 2912 SF	84"-85 3/16" (2,134-2,164 mm)	36" (915 mm)	24" (610 mm)	3/4" (19 mm)

Installation

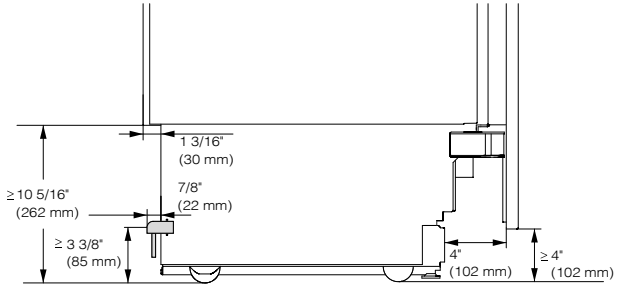

Side view

Dimensions when the appliance door is open (opening angle 90°/115°)

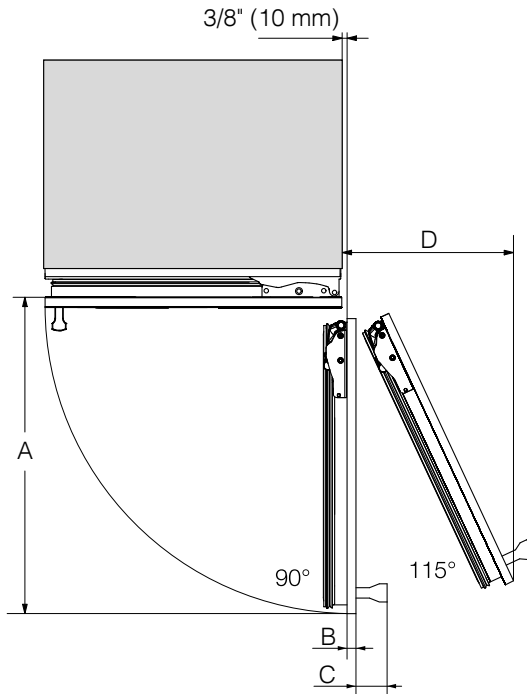

	A	B	C	D
K 26x2 SF	26 5/8" (677 mm)	Cabinet front	Door handle	11 5/8" (296 mm)
K 28x2 SF	32 5/8" (829 mm)	Cabinet front	Door handle	14 5/16" (363 mm)
K 29x2 SF	38 11/16" (982 mm)	Cabinet front	Door handle	16 7/8" (428 mm)

Installation

Building in the appliance

Before starting...

It is essential to read these installation instructions carefully before starting to install the appliance.

The appliance should be installed by a suitably qualified tradesman in accordance with these installation instructions. Safe operation of the appliance is only assured if it has been installed and connected in accordance with the installation instructions.



⚠ Risk of damage and injury!

This appliance is very heavy and can tip forwards when the door is open.

Keep the appliance door shut until the appliance has been built in and secured in its housing in accordance with the operating and installation instructions.

The appliance is both large and heavy. Installation must be carried out by two people.

The appliance must be installed in accordance with local regulations. If local regulations are not available, the following regulations must be observed:

- in the USA: the National Electric Code, ANSI/NFPA 70 - latest edition/ State and Municipal codes and/or local codes.
- in Canada: the Canadian Electric code C22.1 - latest edition/Provincial and Municipal codes and/or local codes.

Tools required

- Cordless drill
- TX 20 screwdriver
- Hammer drill
- Drill bits in various sizes, depending on materials
- Hammer
- Open-ended wrench
- Ratchet wrench, attachment: socket, 5/16" (8 mm)
- Adhesive tape
- Utility knife
- Pipe wrench
- Level
- Tape measure
- Pencil

Other

- Step ladder
- Hand truck

Aligning the installation niche

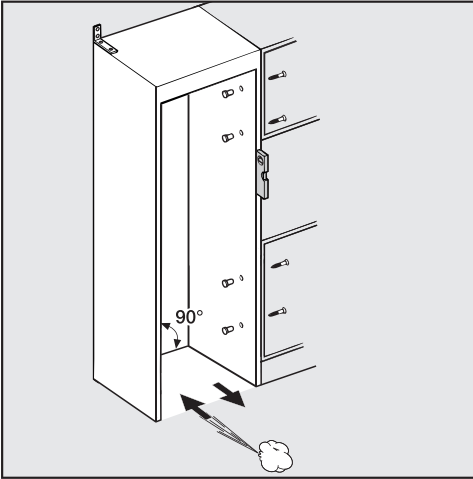

The building-in niche must be carefully aligned using a spirit level before the refrigeration appliance is installed. The niche corners must be at 90° angles to each other, otherwise the cabinet front will not sit straight on all 4 corners of the building-in niche.

Checking the installation niche

- Check the installation dimensions (see “Installation – Installation dimensions”).
- Check the position of the electrical connection. The length of the power cord is 9' 10" (3 m).

The electrical socket must not be concealed behind the appliance and must be easily accessible in an emergency.

- Check the surroundings for possible collisions (see “Installation – Dimensions with appliance door open”).
- Only install the refrigeration appliance in stable, solid installation niches, positioned on an even and level floor.
- Also check the installation niche for the following criteria:
 - The side panels of the installation niche must be even.
 - The surrounding walls of the installation niche must be at least 5/8" (16 mm) thick.
 - The surrounding walls must be securely fixed to the floor or wall.
 - Shortened side walls must be at least 4" (100 mm) deep.

Installation

Before installation

- Before installation, remove any accessories from the back of the appliance.
- Check the refrigeration appliance for damage during transportation.

Do not install a damaged appliance.

- Check that all parts at the back of the appliance are unhindered.
- To protect the floor during installation, secure an off-cut of flooring or similar material to the floor in front of the installation area.

 Risk of damage and injury due to the refrigeration appliance tipping over.

As soon as you unscrew the brackets that fix the refrigeration appliance to the pallet, the appliance is no longer secured.

Due to its weight and size, the refrigeration appliance **must be installed by two people**.

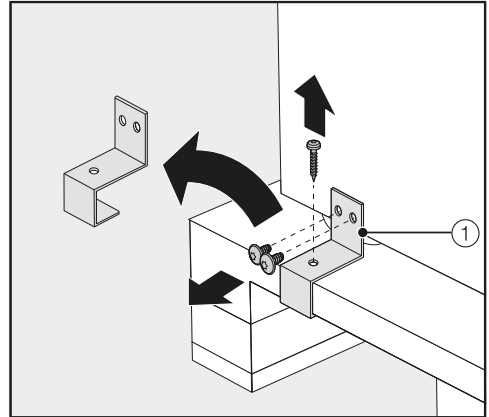

- Unscrew the fixing brackets ①.
- With the help of several people as required, carefully lift the refrigeration appliance from the pallet, starting with the back of the appliance.

 Risk of damaging the floor from the load.

Moving the refrigeration appliance can cause damage to the floor. Move the refrigeration appliance carefully on floors that are sensitive to scratching.

As soon as you have set the appliance upright, you can move it using the rollers on the bottom.

Preparing the installation niche

 Risk of damage and injury due to the refrigeration appliance tipping over.

This refrigeration appliance is very heavy and can tip forwards when the doors are open.

The installation niche must be secured to the wall behind it and/or above it with several screws. Only this will prevent the refrigeration appliance from tipping over after being installed.

In addition, use the provided anti-tip brackets to secure the installation niche.

The parts required for installation are supplied with the refrigeration appliance. The plastic bags supplied are marked with letters for easy identification.

- When performing the individual assembly steps, observe the letters specified and use the matching plastic bag with the required installation equipment.

The anti-tip brackets prevent the refrigeration appliance from tipping.

The anti-tip brackets are also used to fix the installation niche securely to the surrounding walls.

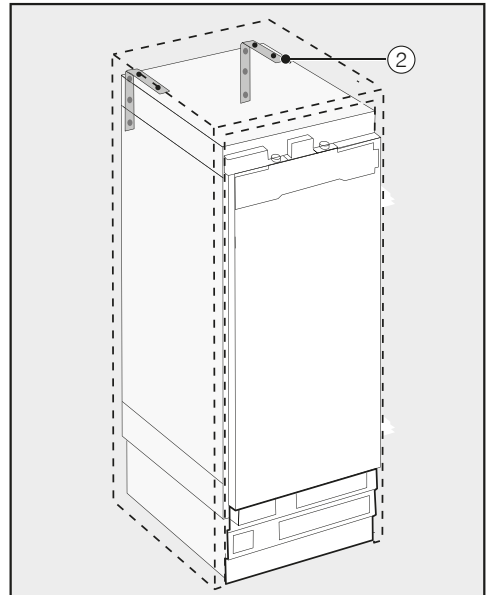

- Use 2 anti-tip brackets ② for each individual appliance or 4 anti-tip brackets for each (side-by-side) combination of 2 appliances.
- Position the anti-tip brackets ② on the left and right of the niche.

Depending on the subsequent adjustment of the feet, the anti-tip brackets are positioned 84"-85 3/16" (2,134–2,164 mm) from the floor of the niche.

Installation

 Risk of damage and injury due to the refrigeration appliance tipping over.

If the anti-tip brackets are fixed too high up, they cannot be used to secure the refrigeration appliance.

The distance between the anti-tip brackets and the refrigeration appliance must not exceed 5/16" (8 mm).

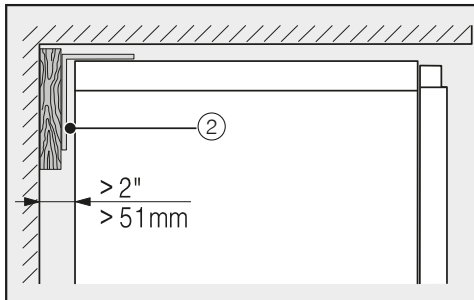
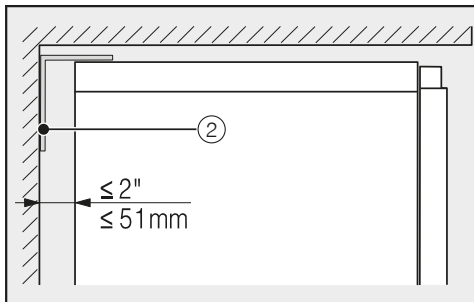

- Make sure that the gap between the refrigeration appliance's rear wall and the installation niche does not exceed 2" (51 mm).
- Place a wooden wedge behind the anti-tip brackets ② if necessary.
- While holding the anti-tip brackets in place, mark the necessary drill holes on the rear wall of the installation niche.



Retaining screws for different uses and types of material are supplied in the accompanying pack.

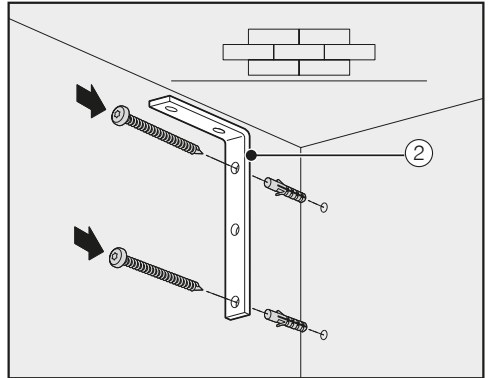

Securing to a concrete wall

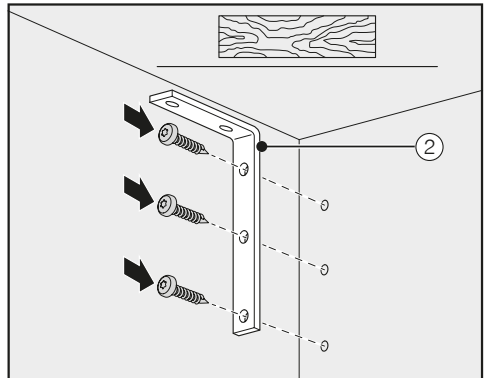

Securing to a wooden wall

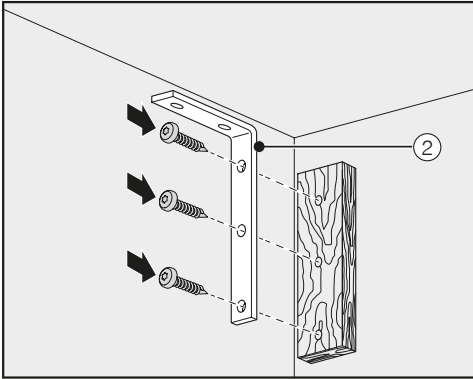

Securing with a wooden wedge

- Secure the installation niche to the wall behind it and/or above it as required using the anti-tip brackets ②.

Pushing the appliance into the niche

Then push the appliance into the niche, taking care not to damage the electrical connection!

If you are installing several refrigeration appliances side by side, now secure the appliances to one another (see the installation instructions for the side-by-side installation kit).

- To ensure that the refrigeration appliance can then be aligned correctly, the toe-kick ventilation grille must be removed from the appliance toe kick:

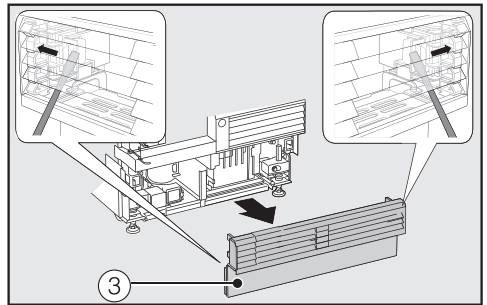

- Carefully guide a flat-head screwdriver through the toe-kick ventilation grille ③ on both sides and use it to push the internal plastic latches outwards to release the toe-kick ventilation grille.
- Place the toe-kick ventilation grille to one side.

Installation

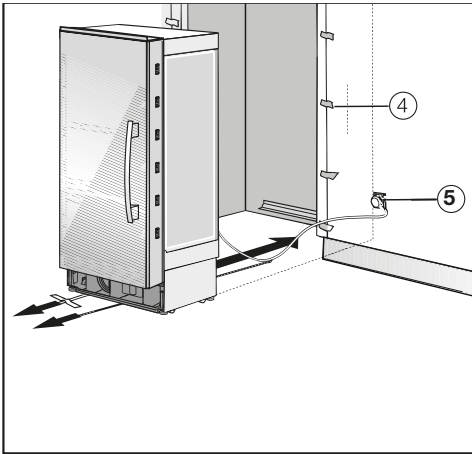

- Affix edge protection ④ to the adjacent cabinet fronts.
- Insert the plug connector at the back of the refrigeration appliance (see “Installation – Electrical connection”).
- Insert the plug ⑤ into the electrical socket.

The electrical socket must be close to the refrigeration appliance and easily accessible.

⚠ Risk of damage due to electrical overload.

If the refrigeration appliance is electrically overloaded, this can cause a short circuit and thus damage your refrigeration appliance.

When you install appliances side by side, each refrigeration appliance must have its own separate electrical socket.

Tip: Secure the power cord to prevent it becoming caught: tie a piece of string to the middle of the power cord and as the refrigeration appliance is being pushed into the niche, pull the cord forward underneath the appliance.

- Carefully push the refrigeration appliance into the niche.
- If the refrigeration appliance cannot be pushed into the niche (because the floor is uneven, for example), unscrew the rear feet slightly (see “Installation – Aligning the refrigeration appliance”) and slide the refrigeration appliance into the installation niche.
- Remove the edge protection ④ from the adjacent cabinet fronts.

Aligning the refrigeration appliance

- Align the appliance with neighboring cabinet fronts as described below.

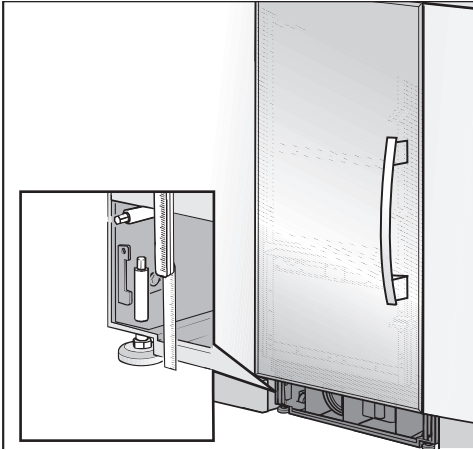

The adjustable feet at the front and back of the appliance can all be adjusted from the front of the appliance.

⚠ Risk of damage due to incorrect feet adjustment.
You may damage the adjustable feet if you use a cordless screwdriver. Always adjust the front and rear feet by hand.

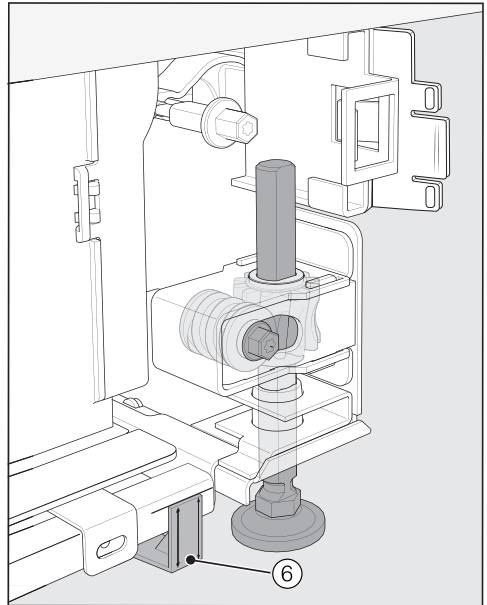

- Position the supplied spacers ⑥ on both sides on the markings next to the adjustable feet at the front of the appliance.

Installation

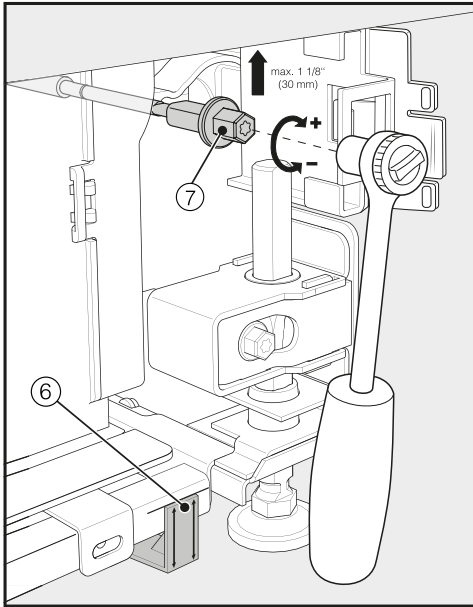

- Adjust the rear feet with a ratchet (attachment: socket, 8 mm) or a TX 20 screwdriver (7).

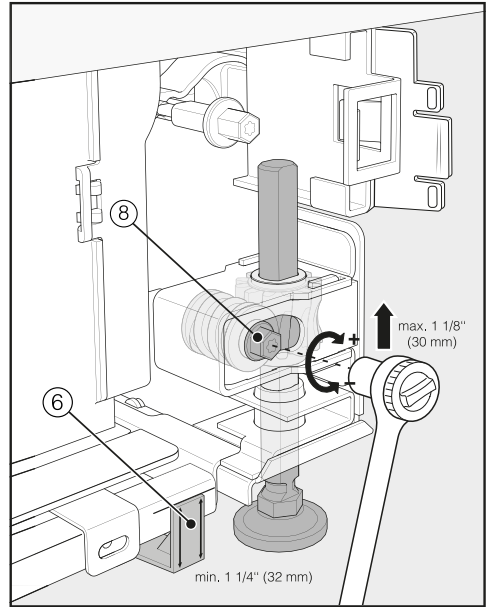

- Adjust the front feet with a ratchet (attachment: socket, 8 mm) or a TX 20 screwdriver (8).

Tip: Proceed carefully when adjusting the feet, alternating between the left and right feet.

- Unscrew the adjustable feet (7) and (8) on both sides at least until the marking on the toe-kick is aligned with the required 1 1/4" (32 mm) on the spacer (6). The standard dimension of 1 1/4" (32 mm) relates to a niche height of 84" (2,134 mm).

It is important to adjust the feet to a height of at least 1 1/4" (32 mm) so that the ventilation of the refrigeration appliance via the toe-kick functions correctly.

 Risk of damage if the feet are adjusted too much.

The rear adjustable feet can be damaged.

Unscrew the feet **only until** the marking on the toe-kick is aligned to a maximum of 2 7/16" (62 mm) (max. niche height of 85 3/16" (2,164 mm)).

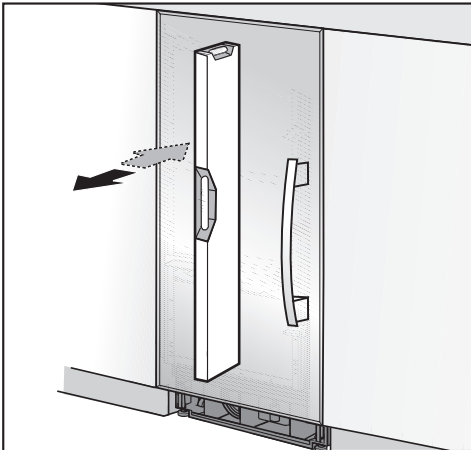

- Use a level to check the alignment of the appliance.

Securing the appliance in the niche

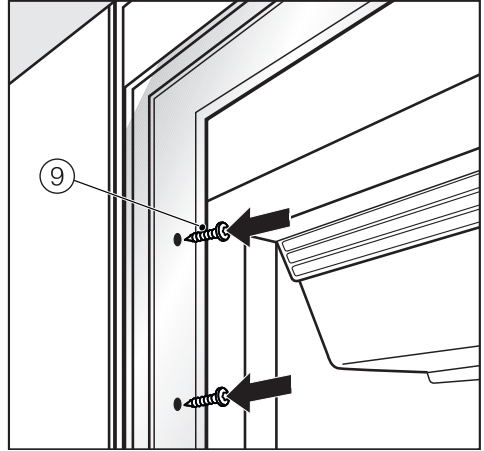

- Use the screws supplied ⑨ to secure the refrigeration appliance on both sides.

In a side-by-side combination, only the external panels of the two appliances can be secured to the cabinet wall.

Installation

Securing the toe-kick board and cover

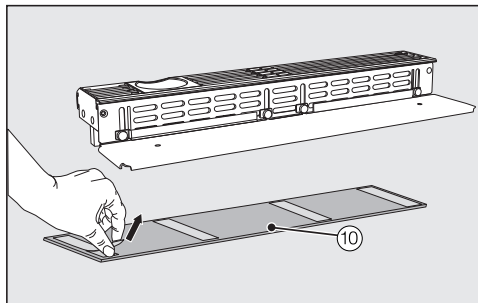

- Remove the film from the adhesive strips on the toe-kick cover provided ⑩.

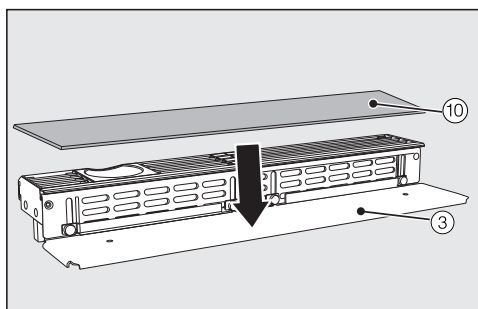

- Secure the toe-kick cover ⑩ to the toe-kick board ③.

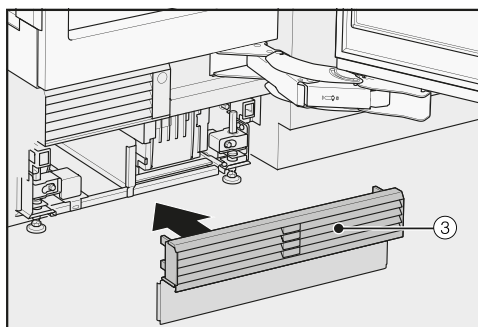

- Click the toe-kick board ③ onto the bottom of the appliance toe-kick.

Aligning the appliance door

Following installation, align the appliance door with adjacent cabinet fronts.

To do this, check the gaps to the adjacent cabinet fronts.

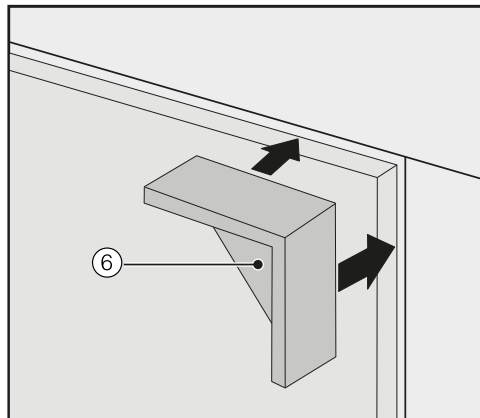

- If necessary, use the spacers provided ⑥ and place them on both sides of the appliance door at the top.

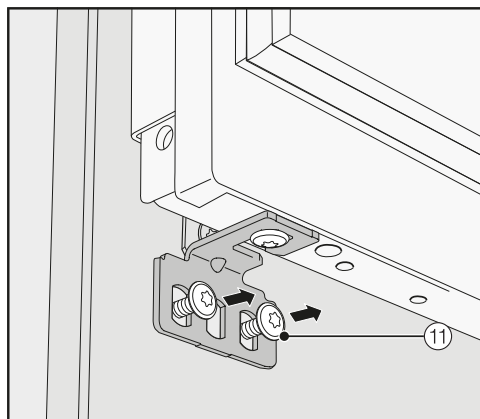

- Slightly loosen the screws ⑪ on the fixing bracket.

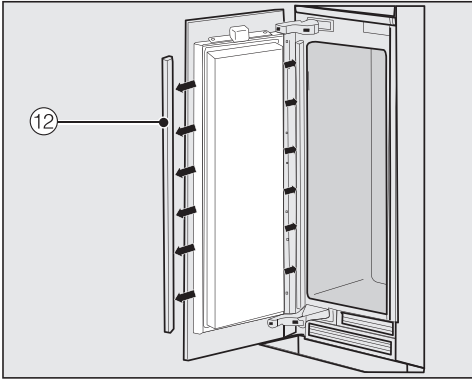

- Remove the covers 12 from both sides of the appliance door.

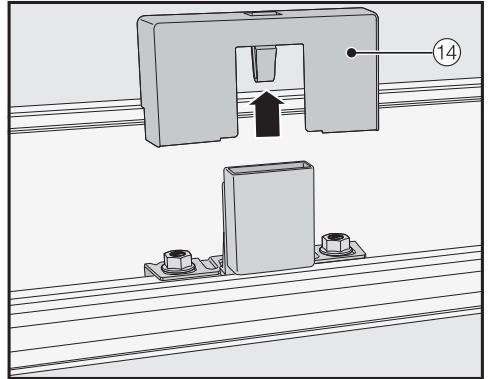

- Remove the cover 14 from the light contact switch.

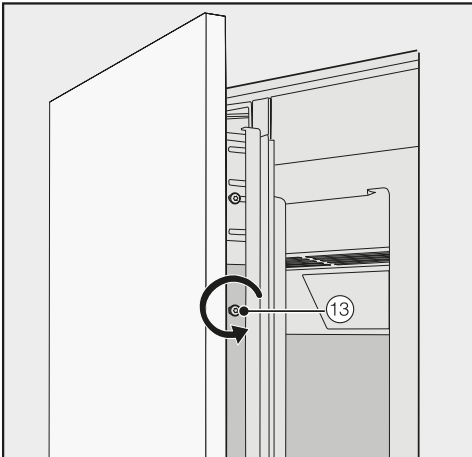

- Slightly loosen the screws 13 in the angle trims on both sides.

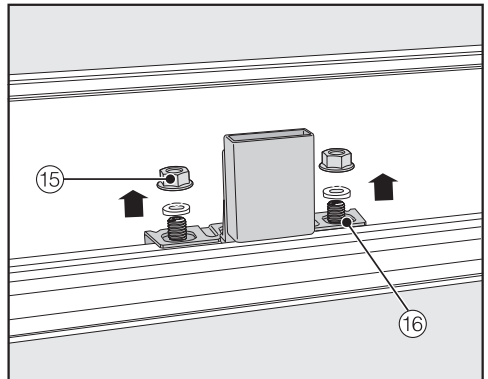

- Remove the nuts 15 and washers from the threaded bolts 16.

Installation

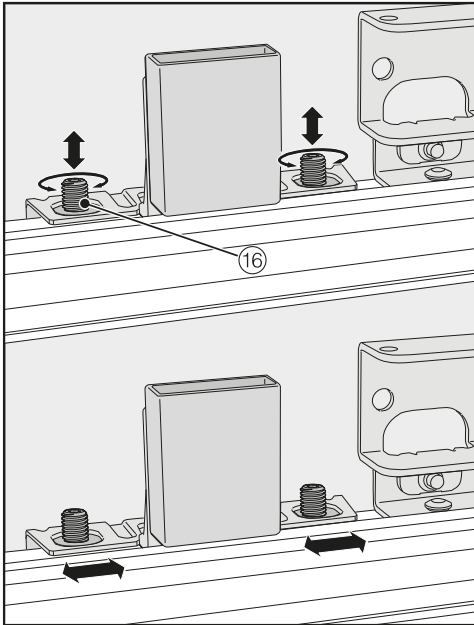

- Align the height and sides of the appliance door using the threaded bolts 16.

- Close the appliance door and check the distance between the door and adjacent cabinet fronts again.
- Then re-tighten all screws 11 and 13.

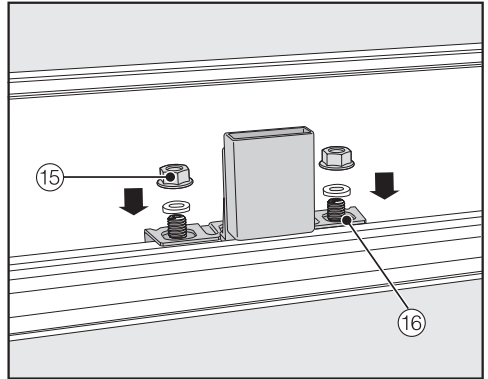

- Place the washers and nuts 15 back on the threaded bolts 16 and tighten the nuts. The appliance door is now secured.
- Reattach covers 12 and 14.

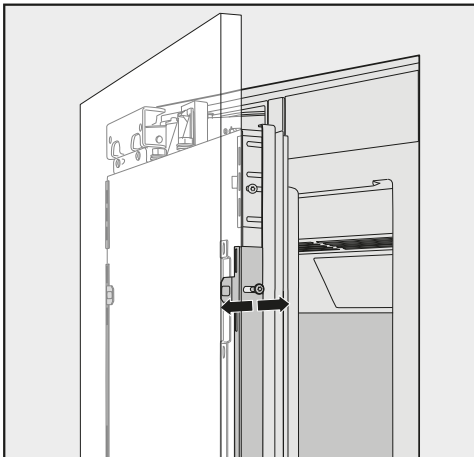

- If necessary, also align the depth of the appliance door via the gaps in the angle trims.

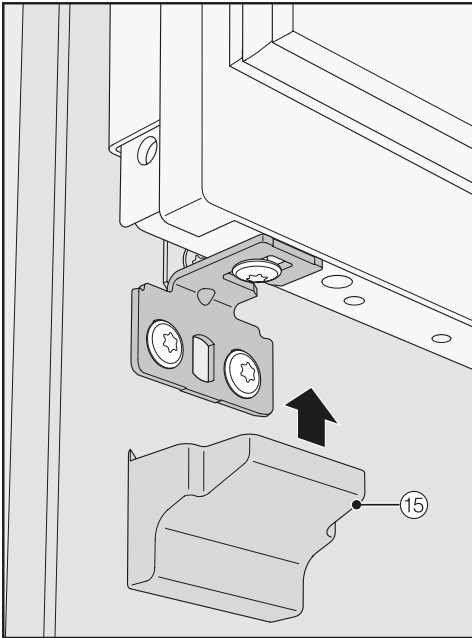
E

- Place the covers provided ⑮ on the fixing brackets.
- Remove the spacers ⑥ from the appliance door.

D

Limiting the opening angle of the appliance door

The door hinges are set ex works to enable the appliance door to be opened wide.

If, for example, the appliance door hits an adjacent wall when it is opened, you should limit the opening angle of the appliance door to 90°:

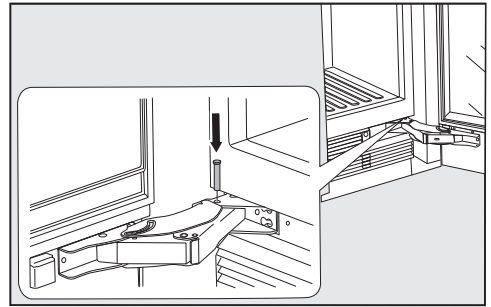

- Open the appliance door.
- Insert the pin into the lower hinge from above.

This will limit the opening angle of the appliance door to 90°.

Installation

Electrical connection



Risk of electric shock!

The appliance must only be switched on when it has been installed in accordance with the installation instructions.

Ground the appliance.

The appliance must not be grounded via a gas pipe.

If in doubt, have a suitably qualified and experienced electrician check that the installation complies with relevant regulations.

Do not install a fuse into neutral current or grounding electrical circuit.

Do not use extension cords or ungrounded (two prong) adapters.

Do not use a frayed or damaged power cord.



Risk of electric shock!

For protection against electric shock, this appliance is equipped with a pole-free plug which is protected against reverse polarity. The electrical outlet must be properly grounded.

Do not remove the round grounding connector pin from the plug.

Use only a grounded plug adapter.

Wait for 1 hour after installation before plugging the appliance into the power supply. This allows coolant and refrigerator oil to settle in accordance with regulations.

Ensure that the voltage of the power supply corresponds with the connection voltage of the appliance. A power supply of 110–120 V, 60 Hz and 10–16 Amp, which is protected by a power switch or a fuse, is required to operate the appliance.

The manufacturer recommends operating the appliance on a dedicated circuit to avoid overloading the electrical circuit.

All relevant legal electrical, fire, and building regulations must be observed when installing the electrical outlet and/or the appliance.

In certain countries, appliances are required to be connected to the electrical supply via a wall-mounted ON/OFF switch.

To avoid the risk of fire, electric shock, or other injuries, the appliance must be installed and connected by a suitably qualified electrician in accordance with all relevant local and national regulations and standards, including fire prevention.

The socket must not be concealed behind the appliance and must be easily accessible so that the appliance can be quickly disconnected from the electrical supply in case of an emergency.

If the outlet is no longer accessible after installation, an additional means of disconnection must be provided for all poles. Suitable means of disconnection include switches with an all-pole disconnect device with a contact opening of at least 1/8" (3 mm). These can be circuit breakers, fuses, and relays.

The plug and power cord must not come into contact with the back of the appliance as vibrations can cause damage to these components. This could result in a short circuit.

Do not plug other appliances into electrical outlet behind this appliance.

Do not connect the appliance to a stand-alone inverter such as those used with an autonomous energy source e.g., **solar power**.

When the appliance is turned on, power surges could result in a safety switch-off. This can damage the electronics. The appliance must not be used with so-called **energy saving devices** either. These reduce the amount of energy supplied to the appliance, causing it to overheat.

If the power cord needs to be replaced, this must be performed by a qualified technician.

Connecting the appliance

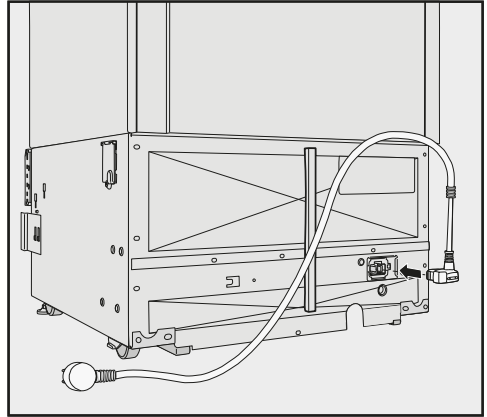

- Insert the plug into the back of the appliance.

Make sure that the plug has clicked into position correctly.

- Insert the plug into the electrical outlet and switch on.

The appliance is now connected to the electricity supply.

Saving energy

	Normal energy consumption	Increased energy consumption
Installation / Maintenance	In a well-ventilated room.	In an enclosed, poorly ventilated room.
	Protected from direct sunlight.	In direct sunlight.
	Away from heat sources (radiator, range/oven).	Near a heat source (radiator, oven).
	Where the ideal room temperature is approx. 68°F (20°C).	Where the ambient room temperature is above 77°F (25°C).
	Air vents uncovered and dusted regularly.	Where the ventilation openings are blocked and full of dust.
Temperature setting	39°F to 41°F (4°C to 5°C) in the refrigerator section	The lower the temperature in the appliance, the higher the energy consumption.
	Dry compartment in the MasterFresh zone approx. 32°F (0°C).	

Saving energy

	Normal energy consumption	Increased energy consumption
Use	The drawers, and shelves are arranged as they were when the appliance was delivered.	
	Only open the door when necessary and for as short a time as possible. Store food in an organized way.	Frequent opening of the door for long periods will cause a loss of coldness. The appliance will try to cool down and the compressor will run for longer periods.
	When shopping, use a cooler bag and place the food in the appliance as soon as possible. Replace any food removed as quickly as possible, before it warms up too much. Allow hot food and drinks to cool down before placing them in the appliance.	Hot food or food at room temperature raises the temperature inside the refrigeration appliance. The appliance will try to cool down and the compressor will run for longer periods.
	Store food well packaged or covered.	The evaporation or condensation of liquids in the refrigerator section will cause a loss of coldness.
	Place frozen food in the refrigerator section to defrost.	
	Do not overfill the appliance in order to allow the air to circulate.	Poor air circulation will cause a loss of coldness.

Guide to the appliance

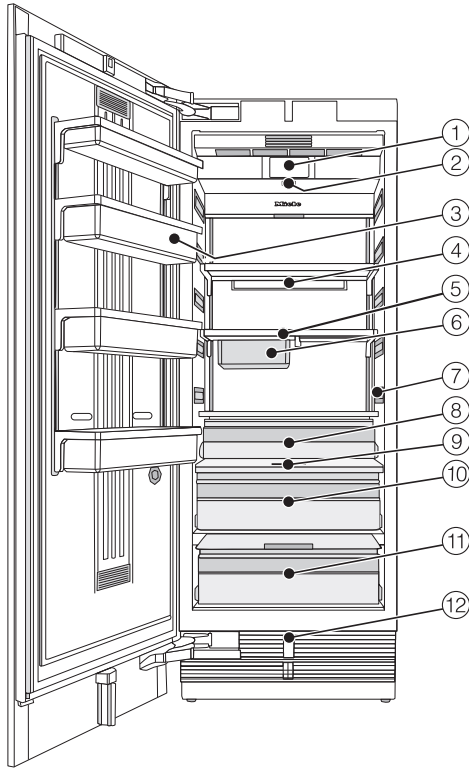

- ① Display
- ② On/Off switch
- ③ Door shelves in the appliance door
- ④ Holder for the Active AirClean filter
- ⑤ Shelves
- ⑥ Hanging drawer for storing small food items
- ⑦ Interior lighting
- ⑧ Fruit and vegetable drawer
- ⑨ Moisture regulator
- ⑩ Humidity-controlled compartment with moisture regulator for fruit and vegetables
- ⑪ Dry compartment with temperature adjustment for meat and fish
- ⑫ Automatic door opening (Push2open/Pull2open)



Guide to the appliance

The dry compartment in the MasterFresh zone fulfills the requirements of a cold storage compartment according to EN ISO 15502.

Guide to the appliance

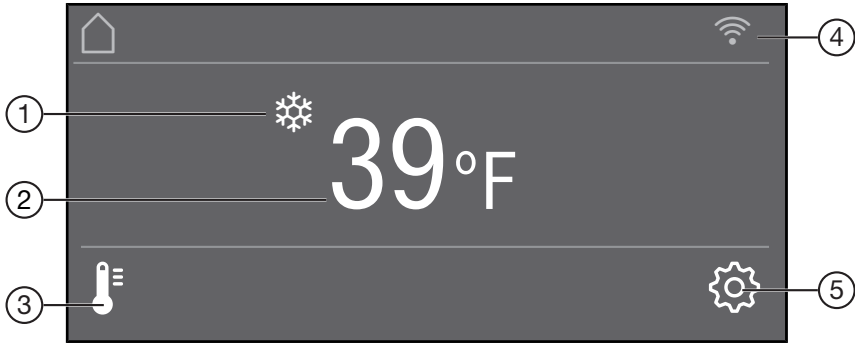









Main screen







- ① Automatic SuperCool display
(only visible when the Automatic SuperCool function has been switched on)
- ② Temperature display (target temperature)
- ③ Sensor control 
for setting the temperature
- ④ Display for Miele@home connection status
(only visible when the Miele@home function has been set up)
- ⑤ Settings mode sensor control 
for adjusting various settings in Settings mode

Settings mode





In Settings mode, you can select the following appliance functions and alter their settings to some extent:

Symbol		Function
	Language	Set
	Display Brightness	Adjust (darker to brighter)
	Color Scheme	Set (dark or bright)
	Buzzer Tones	Adjust the volume or switch off the Buzzer Tones completely (e.g., for the door alarm)
	Keypad Tone	Adjust the volume or switch off the Keypad Tone completely
°F / °C	Temperature Unit	Set (°Fahrenheit or °Celsius)
	Keypad Lock	Switch on or off (see “Selecting additional settings”)
	MasterFresh	Adjust the temperature in the dry compartment (see “Selecting additional settings”)
	Eco Mode	Switch on or off (see “Selecting additional settings”)
	Self Test	The system restarts and is checked for faults or malfunctions (see “Selecting additional settings”)
	Door Assistant	Switch on (Push2Open or Pull2Open) or switch off (see “Selecting additional settings”)
	Miele@home	Set up, deactivate, or query WiFi connection status (see “Selecting additional settings”)

Guide to the appliance

	Demo Mode	Switch off * (only visible when Demo Mode, is switched on see “Selecting additional settings”)
	Factory Default	Reset to default settings (see “Selecting additional settings”)
	Sabbath Mode	Switch on or off (see “Selecting additional settings”)
	Display Active Air-Clean Filter	Switch on or off or reset (see “Selecting additional settings”)

Symbols in settings mode

	Scroll in settings mode or select a setting
	Change a setting (e.g., display brightness)
	Confirm a setting
	Exit the menu level

Accessories supplied

Appliance plug

Active AirClean filters

The Active AirClean filters neutralize unpleasant odors in the refrigerator section and stop odors from being transferred to the food.

Insert the supplied Active AirClean filters as described under “Cleaning and care – Replacing the Active AirClean filters”.

We recommend replacing the Active AirClean filters every 6 months.

Toe-kick cover in stainless steel look

The toe-kick cover in stainless steel look ensures a uniform stainless steel appearance.

Optional accessories

A range of useful Miele accessories and care products are available for your appliance.

Active AirClean filters

See “Accessories supplied” for a description.

Active AirClean filters with holder

The Active AirClean filters neutralize unpleasant odors in the fridge zone and stop odors from being transferred to the food.

The holder for the Active AirClean filters can be fixed under any shelf in the fridge zone.

Side-by-side installation kit and Top Frame

To install two or more refrigeration appliances next to one another, you will need the side-by-side installation kit (see “Installation – Side-by-side”).

You also need a cover (Top Frame KTF) to connect the appliances and to cover the gap above the tops of the appliances.

Hinge pocket

If the door hinging needs to be changed on your refrigeration appliance, the upper toe-kick ventilation grille must be converted. A new hinge pocket is required in order to do this.

The door hinging must only be replaced by Miele Technical Service.

Accessories are available to order via the Miele Webstore, from Miele directly (see back cover for contact details) or from your Miele dealer.

Before first use

Before first use

Allow the appliance to stand for approx. 1 hour prior to connecting it to the power supply. This will help prevent any malfunctions.

Packaging material

- Remove all packaging material from the inside of the appliance.

Leftover tape residue. Always remove all packaging material, including adhesive tape, **before** switching on the appliance.

Cleaning

Please refer to the relevant instructions in “Cleaning and care”.

- Clean the inside of the appliance and the accessories.

Choosing the right Door Assistant (Push2Open/Pull2Open)

The Door Assistant helps you to open the appliance door.

You can choose between the two Door Assistants Push2Open and Pull2Open (see “Selecting additional settings – Switching on the Door Assistant ”).

The default Door Assistant is Push2Open.

- Select the Pull2Open Door Assistant if your appliance has a cabinet front with a handle.
- Select the Push2Open Door Assistant if your appliance has a handle-free cabinet front.

Inserting the Active AirClean filters

Your refrigeration appliance is equipped with 2 Active AirClean filters which neutralize unpleasant odors in the refrigerator section.

- Insert the Active AirClean filters supplied as described under “Cleaning and care – Replacing the Active AirClean filters”.

Miele@home

Your refrigeration appliance is equipped with an integrated WiFi module.

Networking is deactivated at the factory.

To use this feature, you will need:

- a WiFi network
- the Miele app
- a Miele user account You can create a user account via the Miele app.

The Miele app will guide you as you connect your refrigeration appliance to your home WiFi network.

Once the refrigeration appliance is connected to your WiFi network, you can use the app to carry out the following activities, for example:

- Call up information on the operating status of your refrigeration appliance.
- Change the settings on your refrigeration appliance.

Connecting your refrigeration appliance to your WiFi network will increase energy consumption, even when the appliance is switched off.

Make sure that the signal of your WiFi network is sufficiently strong in the place where you want to set up your refrigeration appliance.

Availability of the WiFi connection

The WiFi connection shares a frequency range with other appliances (including microwave ovens and remote control toys). This can cause sporadic or even complete connection failures. Therefore, the availability of featured functions cannot be guaranteed.

Miele@home availability

The ability to use the Miele app depends on the availability of the Miele@home service in your country.

The Miele@home service is not available in every country.

For information about availability, please visit www.miele.com.

Miele App

The Miele App is available to download free of charge from the Apple App Store® or from the Google Play Store™.



Before first use

Operating the refrigeration appliance

The touch display can be scratched by pointed or sharp objects, e.g., pens.
Only touch the display with your fingers.
If your fingers are cold, the touch display may not react.

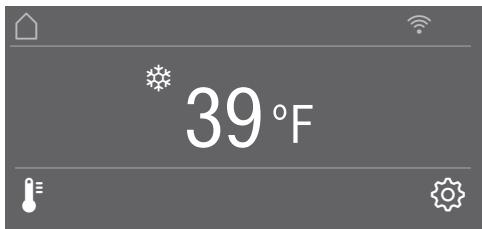

The sensor controls underneath the temperature display can be **selected** directly by touch; the symbols and text in or above the temperature display can only be **displayed**.

Settings mode

In Settings mode , you can select different refrigeration appliance functions and alter their settings to some extent (see “Selecting additional settings”).

- Touch the  sensor control to open Settings mode.
- Use the < and > sensor controls to select the function for which you wish to adjust the settings.
- Confirm your selection with *OK*.
- Adjust the settings using either the < and > sensor controls or the + and – sensor controls.
- Confirm your selection with *OK*.

The setting with the **colored** background is always the **selected** setting; it can be confirmed directly with *OK*.

- Touch the  sensor control if you wish to switch to the previous menu level or terminate the process.

Every touch of the display is confirmed with an audible keypad tone. You can switch off this keypad tone in Settings mode .

Starting up for the first time

- Open the appliance door.

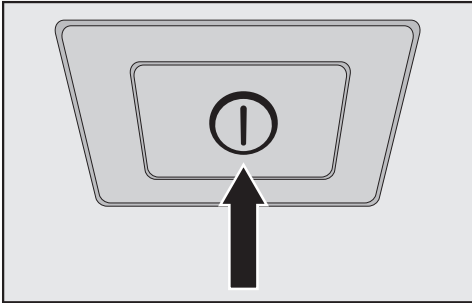



- Turn the refrigeration appliance on by pressing the On/Off switch.

The On/Off switch is located below the display.

The refrigeration appliance will start to cool and the interior lighting will come on when the appliance door is opened.

Miele will appear in the refrigeration appliance display.

- When you turn the appliance on for the first time, you will be asked to configure the following settings:
 - Set the Language (if you accidentally select the wrong Language, return to Settings mode  and use the  symbol to change the language)
 - Set the Temperature Unit: °C (degrees Celsius) or °F (degrees Fahrenheit)
 - Set up Miele@home:
- Select Continue if you would like to set up Miele@home now. You will then be guided by the display and the Miele app.

As soon as your refrigeration appliance has been integrated into your WiFi network, the message **Connection successful** will appear on your refrigeration appliance's display.

- Confirm the process with *OK* again.

If the WiFi connection is active,  will appear in the display.

- Select *Skip* if you would prefer to set up Miele@home later.
- Touch the  sensor control if you want to return to the previous menu level.

Set-up Successful will appear in the display.

- Confirm the initial start-up with *OK*.

The main screen will appear on the display (see “Appliance description – Main screen”).

You cannot terminate the initial start-up process. The only way to terminate the process is to switch off the refrigeration appliance, though the process will continue when the appliance is switched back on.

Switching on and off

Switching on the appliance

- Open the appliance door.
- Turn the refrigeration appliance on by pressing the On/Off switch.

The refrigeration appliance will start to cool and the interior lighting will come on when the appliance door is opened.

Miele will appear, followed by the main screen on the refrigeration appliance display:

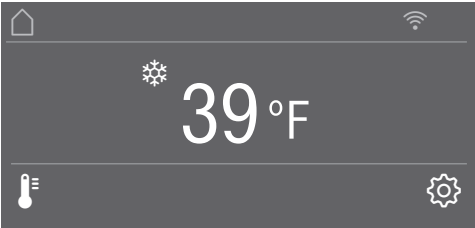

To enable the temperature to get sufficiently cold inside the appliance, allow the appliance to run for a few hours before placing food in it.

 Risk of damage due to high humidity.

In environments with high humidity, condensation can build up on external refrigeration appliance panels. This condensation can cause corrosion and lead to damage on external appliance panels.

Install the refrigeration appliance in a dry and/or air-conditioned room with sufficient ventilation.

Do not switch the refrigeration appliance on if you are going to be away for a long period of time.

Do not leave the refrigeration appliance unattended for a long period of time while it is switched on.

Switching off the appliance

- Turn the refrigeration appliance off by pressing the On/Off switch.

The cooling and interior lighting are switched off.

Please note: the refrigeration appliance is not disconnected from the power supply when the On/Off switch is in the “Off” position.

Switching off for longer periods of time

If the appliance is not going to be used for a longer period of time:

- Turn the appliance off.
- Unplug the appliance or trip the circuit breaker.
- Clean the refrigeration appliance.
- Leave the door ajar to air the refrigeration appliance and avoid odors building up inside the appliance.

If, during a long absence, the refrigeration appliance is switched off but not cleaned and the door(s) left shut, there is a danger of bacteria building up inside the appliance.

It is essential to clean the refrigeration appliance.

Selecting additional settings

In settings mode , certain settings can be adjusted and functions selected, allowing you to adjust the machine to suit your requirements.

The following section only describe the functions in settings mode  that require further explanation.

The door alarm and other warnings are automatically disabled when the appliance is in settings mode .

The display is unlocked briefly so you can adjust the setting as required. Closing the appliance door will reactivate the sensor lock.

Switching Keypad Lock / on or off

Switch Keypad Lock on if you wish to protect your refrigeration appliance from unwanted temperature changes or other unintentional adjustments in Settings mode .

- In Settings mode , use the < and > sensor controls to select Keypad Lock and select OK to confirm your selection.
- Use the < and > sensor controls to switch the sensor lock On or Off and select OK to confirm your selection.
- The keypad lock will not be activated until you close the appliance door.

Nothing will appear on the display to indicate that the keypad lock is switched on.

The message Press OK for 6 seconds to unlock will appear on the display if you select a sensor control while the sensor lock is switched on.

- Follow the instructions on the display.

Adjusting the temperature in the MasterFresh zone (dry compartment)

- In Settings mode , use the < and > sensor controls to select MasterFresh and select OK to confirm your selection.
- Use the – and + sensor controls to select the desired temperature and touch OK to confirm your selection.
- Touch the ↶ sensor control if you wish to terminate the process.

The segment bar displays 5 segments; the temperature is adjusted in increments of approx. 34°F (1°C).

The factory default setting for the temperature in the dry compartment is 32°F (0°C).

Switching Eco Mode on or off

Eco Mode is useful when going on vacation, for example, if you do not wish to switch off the appliance completely or do not need a high degree of cooling. Energy consumption in Eco Mode is lower than in normal operation.

The refrigerator section is thereby regulated to a temperature of 43°F (6°C) and the dry compartment in the MasterFresh zone to approx. 34°F (1°C).

If the Automatic SuperCool  function is switched on, this will be automatically switched off when Eco Mode is selected.

- In Settings mode , use the < and > sensor controls to select Eco Mode and select OK to confirm your selection.
- Use the < and > sensor controls to switch Eco Mode On or Off and select OK to confirm your selection.

Only the changed temperature on the display indicates that Eco Mode is switched on.



Tip: You can also switch off the Eco Mode function by directly adjusting the temperature  (see “The correct temperature”) – Setting the temperature”).

Storing food at a temperature of 43°F (6°C) for an extended period of time may impair the shelf life and quality of the food.

Selecting additional settings

Performing a Self Test

Perform a Self Test if you are concerned that your refrigeration appliance is not working properly and want to check if it is suffering from any problems.

- In Settings mode , use the < and > sensor controls to select Self Test and select OK to confirm your selection.
- Touch the  sensor control if you wish to terminate the process.

The Self Test starts and the appliance is checked for any faults or malfunctions.

- The message System restart will appear on the display if the Self Test does not discover any faults or malfunctions.
- If the Self Test does discover any faults or malfunctions, they are indicated as error messages on the display.

An alarm will also sound.

- If you find the alarm disruptive, you can switch it off in advance by touching the  sensor control.
- Make a note of the error message(s) displayed.
- Contact Miele Service and inform them of the error message(s) on the display.
- Confirm the message with OK.

System restart will appear on the display.

The refrigeration appliance briefly switches off and then back on automatically.

Self test completed will appear on the display.

- Confirm the message with OK.

The main screen appears on the display again.

Switching on the Door Assistant





You can choose between the two Door Assistants *Push2Open* and *Pull2Open*. The default Door Assistant is *Push2Open*.

The *Push2Open* Door Assistant is suitable for cabinet fronts without handles. The door will then open automatically when you gently press against it.

The *Pull2Open* Door Assistant is suitable for cabinet fronts with handles. The appliance door can be opened easily with little force.

 Risk of damage if the appliance door is closed prematurely. When the Door Assistant is switched on, repeatedly closing the appliance door early can lead to damage or malfunctions. Refrain from holding onto or closing the appliance door while automatic door opening is still extended. If you have indeed closed the appliance door, leave it closed for 5 minutes. Automatic door opening resets itself.



Switching on *Push2Open*

- In Settings mode , use the < and > sensor controls to select *Door Assistant* and select *OK* to confirm your selection.
 - Use the < and > sensor controls to select *Mode* and select *OK* to confirm your selection.
 - Use the < and > sensor controls to select *Push2Open* and select *OK* to confirm your selection.
- Touch the  sensor control to return to the previous menu level.
- #### – Adjusting the intensity
- You can also adjust the intensity of the *Push2Open* function. The lower the set intensity, the less force required when you push against the appliance door.
- In Settings mode , use the < and > sensor controls to select *Door Assistant* and select *OK* to confirm your selection.
 - In Settings mode , use the < and > sensor controls to select *Intensity* and select *OK* to confirm your selection.
 - Use the < and > sensor controls to select the right intensity (*Low*, *Medium*, *High*) and select *OK* to confirm your selection.

Selecting additional settings



– Adjusting the duration of the Auto-Close function

You can also adjust the duration for how long the appliance door will remain open until it closes automatically.

- In Settings mode , use the < and > sensor controls to select Door Assistant and select *OK* to confirm your selection.
- In Settings mode , use the < and > sensor controls to select AutoClose and select *OK* to confirm your selection.
- Use the + and – sensor controls to select the duration (5 to 30 seconds) and touch *OK* to confirm your selection.



To protect against inadvertent opening: if you do not pull the appliance door open, it will close again by itself after a duration defined by you.

Switching on Pull2Open



- In Settings mode , use the < and > sensor controls to select Door Assistant and select *OK* to confirm your selection.
- Use the < and > sensor controls to select Mode and select *OK* to confirm your selection.
- Use the < and > sensor controls to select Pull2Open and select *OK* to confirm your selection.
- Touch the  sensor control to return to the previous menu level.

– Adjusting the intensity

You can also adjust the intensity of the Pull2Open function. The lower the set intensity, the less force required when you pull the appliance door.

- In Settings mode , use the < and > sensor controls to select Door Assistant and select *OK* to confirm your selection.
- In Settings mode , use the < and > sensor controls to select Intensity and select *OK* to confirm your selection.
- Use the < and > sensor controls to select the right intensity (Low, Medium, High) and select *OK* to confirm your selection.

Switching off the Door Assistant

- In Settings mode , use the < and > sensor controls to select Door Assistant and select *OK* to confirm your selection.
- Use the < and > sensor controls to select Mode and select *OK* to confirm your selection.
- Use the < and > sensor controls to select Off and select *OK* to confirm your selection.
- Touch the  sensor control to return to the previous menu level.

Miele@home

Setting up Miele@home

The message Set up Miele@home only appears if the refrigeration appliance has not yet been connected to a WiFi network.

- Connect your refrigeration appliance as described in “Before using for the first time”.

Deactivating Miele@home

- In Settings mode , use the < and > sensor controls to select Miele@home and select *OK* to confirm your selection.
- Use the < and > sensor controls to select Deactivate and select *OK* to confirm your selection.

Deactivation successful will appear on the display.

- Confirm the message with *OK*.

Your refrigeration appliance is now disconnected from your WLAN network.

The  symbol will go out on the display.

Selecting additional settings

Activating Miele@home

If you have already activated Miele@home and then disconnected the connection, you will need to reactivate the connection.

- In Settings mode , use the < and > sensor controls to select Miele@home and select *OK* to confirm your selection.
- Use the < and > sensor controls to select *Activate* and select *OK* to confirm your selection.

Activation successful will appear on the display.





- Confirm the message with *OK*.

If the WLAN connection is active,  will appear on the display.

Checking the WLAN connection status

- In Settings mode , use the < and > sensor controls to select Miele@home and select *OK* to confirm your selection.
- Use the < and > sensor controls to select *Connection status* and select *OK* to confirm your selection.

Information about the WLAN connection status will then appear on the display:

-  connected: there is a strong connection
-  connected: there is an average connection
-  connected: there is a weak connection
-  disconnected

Setting up Miele@home again

If you have changed your WiFi network, you can set up Miele@home again for your appliance.

- In Settings mode , use the < and > sensor controls to select Miele@home and select *OK* to confirm your selection.
- Use the < and > sensor controls to select *Set up again* and select *OK* to confirm your selection.

Reset configuration? will appear on the display.

- Use the < and > sensor controls to select *Yes* or *No* and select *OK* to confirm your selection.

Resetting the network configuration

Reset the refrigeration appliance's settings to the default settings when disposing of your refrigeration appliance, selling it, or putting a used refrigeration appliance into operation. This will reset the network configuration so that all personal data is deleted from the refrigeration appliance. This will also ensure that a previous owner is no longer able to access the refrigeration appliance.

- Reset the settings of the refrigeration appliance as described under "Resetting the settings to their default settings ".

Switching off Demo Mode

Demo mode allows the appliance to be presented in the showroom **without the cooling system being switched on**. Do not activate this setting for domestic use.

If Demo mode has been switched on as a default setting,  will show on the display.

- In Settings mode , use the < and > sensor controls to select Demo Mode and select *OK* to confirm your selection.

Press *OK* for 4 seconds to deactivate **will appear on the display**.

- Follow the instructions on the display.

The countdown Demo Mode will deactivate in seconds. **appears on the display**.

Demo Mode deactivated. The appliance will cool down. **will appear on the display**.

- Confirm the message with *OK*.

The main screen appears on the display again.

Selecting additional settings

Resetting the settings to their default settings

You can reset the refrigeration appliance's settings to their default settings.

Reset the refrigeration appliance's settings to the default settings when disposing of your refrigeration appliance, selling it, or putting a used refrigeration appliance into operation. This will reset the network configuration so that all personal data is deleted from the refrigeration appliance. This will also ensure that a previous owner is no longer able to access the refrigeration appliance.

- In Settings mode , use the < and > sensor controls to select **Factory Default** and select **OK** to confirm your selection.
- Use the < and > sensor controls to select **Reset** and select **OK** to confirm your selection.















After a brief delay, **Settings reset** appears on the display.

- Confirm the message with **OK**.

The initial commissioning process restarts (see “Before first use – Starting up for the first time”).

Selecting additional settings

The refrigeration appliance's settings will be reset to the following values:

Function	Default settings
 Language	English
 Display Brightness	Average value (4 of 7 segments)
 Color Scheme	Dark
 Buzzer Tones	Average value (4 of 7 segments)
 Keypad Tone	Average value (4 of 7 segments)
 °F / °C	°Fahrenheit
 Keypad Lock	Switched off
 MasterFresh	32°F (0°C) (2 of 5 segments)
 Eco Mode	Switched off
 Door Assistant	Push2open
 Miele@home	Switched off
 Sabbath Mode	Switched off
 Display Active AirClean Filter	Switched on
 Temperature in the refrigerator section	37°F (4°C)
 Temperature in the dry compartment	32°F (0°C)

Selecting additional settings

Switching Sabbath Mode on or off

The refrigeration appliance has a Sabbath Mode to support the observance of religious customs.

When Sabbath Mode is switched on, you cannot make any settings on your refrigeration appliance.

Ensure that the appliance door is properly closed, as visual and audible alarms are switched off in Sabbath Mode.

- In Settings mode , use the < and > sensor controls to select Sabbath Mode and select OK to confirm your selection.
- Use the < and > sensor controls to select On or Off and select OK to confirm your selection.

When Sabbath Mode is switched on,  will appear on the display and the display brightness will be reduced (the display does not change when the appliance door is closed).

When Sabbath Mode  is switched on, the following functions are switched off:

- Door Assistant (for cabinet fronts without handles, the appliance door will have to be pulled from the bottom or side)
- Lighting
- All audible and visual signals,
- Temperature display
- The Automatic SuperCool function (if previously switched on)

You can still select:

- the sensor control for Settings mode  so that Sabbath Mode can be switched off

The Sabbath Mode function will switch itself off automatically after approx. 125 hours.

Danger of food poisoning!

Any power failure during Sabbath Mode will not be shown on the display. After a power failure, the appliance will restart in Sabbath Mode. When power is restored, no notification of the power failure will appear on the display.

If there is a power failure during Sabbath mode, check the quality of the food.

Switching on, switching off, or resetting the Display Active AirClean Filter

The Display Active AirClean Filter will remind you approx. every 6 months that the Active AirClean filters have to be replaced. Change Active AirClean Filter will appear on the display.

See “Cleaning and care – Replacing the Active AirClean filters” for instructions on how to replace the Active AirClean filters.

The first time the Active AirClean filters need to be replaced, the display will remind you automatically; the reminder does not need to be switched on separately.

Switching on the Display Active AirClean Filter

If the Display Active AirClean Filter has been switched off once, it must be switched on again if required.

- In Settings mode , use the < and > sensor controls to select the Display Active AirClean Filter and select *OK* to confirm your selection.
- Use the < and > sensor controls to select *On* and select *OK* to confirm your selection.

The Display Active AirClean Filter has been switched on.

Switching off the Display Active AirClean Filter

If you do not require the Display Active AirClean Filter, you can switch it off.

- In Settings mode , use the < and > sensor controls to select the Display Active AirClean Filter and select *OK* to confirm your selection.
- Use the < and > sensor controls to select *Off* and select *OK* to confirm your selection.

The Display Active AirClean Filter has been switched off.

Selecting additional settings

Resetting the Display Active AirClean Filter

After you have replaced the Active AirClean filters, you must reset the Display Active AirClean Filter so that it can be displayed again after 6 months.

If you do not reset the display, it appears again and again.

- In Settings mode , use the < and > sensor controls to select the Display Active AirClean Filter and select *OK* to confirm your selection.
- Use the < and > sensor controls to select *Reset* and select *OK* to confirm your selection.

The Change Active AirClean Filter message disappears from the display.

The Display Active AirClean Filter to replace the Active AirClean filters has been activated.

The correct temperature

It is very important to set the correct temperature for storing food in the appliance. Bacteria will cause food which is not stored at the correct temperature to deteriorate rapidly. Temperature influences the growth rate of these bacteria. Reducing the temperature reduces their growth rate.

The temperature in the appliance will rise:

- the more often the appliance door is opened and the longer it is kept open
- the more food that is stored in it
- the warmer the food is that is being put into it
- the higher the ambient temperature surrounding the refrigeration appliance is. The appliance is designed for use within specific ambient temperatures (climate range). Do not use in ambient temperatures for which it is not designed

... in the refrigerator section and in the MasterFresh zone

We recommend a temperature of 39°F (4°C) in the refrigerator section.

We recommend a temperature of 32°F (0°C) in the dry compartment of the MasterFresh zone.

Automatic cold air circulation (Dyna-Cool)

The fan automatically turns on when the cooling system for the refrigerator section turns on. It distributes the temperature in the refrigerator section to all areas evenly so that all the food inside will be chilled to about the same degree.

The correct temperature

Setting the temperature

- Touch the  sensor control to set the temperature.

The previously set temperature will appear.

- Use the + and – sensor controls to set the temperature. Keeping your finger on the sensor control changes the temperature continuously.
- Confirm the temperature setting with OK or wait approx. 8 seconds after the last touch of the sensor. This temperature will be automatically adopted.

Tip: The new temperature setting can also be confirmed and adopted by closing the appliance door.

The temperature display always shows the **required** temperature.

If you have adjusted the temperature, **wait for approximately 6 hours if the appliance is not very full and for approximately 24 hours if the appliance is full** before checking the temperature display. It will take this long for an accurate reading to be given.

- If, after this time, the temperature is still too high or too low, adjust it again.

Adjusting the temperature in the dry compartment of the MasterFresh zone

The temperature in the dry compartment of the MasterFresh zone is maintained at approx. 32°F (0°C).

However, if you would like it to be warmer or colder, you can adjust the temperature slightly (see “Selecting additional settings – Adjusting the temperature in the MasterFresh zone (dry compartment) ”).

Tip: You can select a lower setting for storing, for example, particularly delicate fish. A slightly higher temperature is preferable for storing ready-to-eat food, for example.

Temperature range

The temperature in the refrigerator section can be set between 36°F (2°C) and 46°F (8°C).

The temperature in the dry compartment in the MasterFresh zone can be set between 30°F (-1°C) and 37°F (3°C).

Automatic SuperCool function ❄️

The Automatic SuperCool function can be used to rapidly reduce the temperature in the refrigerator section to its lowest setting (depending on the room temperature).

Automatic SuperCool is particularly recommended for the rapid chilling of large amounts of fresh food or drink.

Switching on Automatic SuperCool

- Touch the 🌡️ sensor control to set the temperature.
- Touch the ❄️ sensor control to switch the Automatic SuperCool function on.

The ❄️ symbol is highlighted in color and the newly set temperature value of 36°F (2°C) appears on the display.

- Confirm the setting with *OK* or wait approx. 8 seconds after the last press of the button. The setting will be automatically adopted.

The ❄️ symbol is now illuminated on the display.

The appliance will now run at maximum power.

Switching off Automatic SuperCool

- Touch the 🌡️ sensor control to set the temperature.

The ❄️ symbol is highlighted in color and the temperature value of 36°F (2°C) is shown on the display.

- Touch the ❄️ sensor control to switch the Automatic SuperCool function off.

The ❄️ symbol is no longer highlighted in color and the previous temperature setting appears again on the display.

- Confirm the setting with *OK* or wait approx. 8 seconds after the last press of the button. The setting will be automatically adopted.

The ❄️ symbol disappears from the temperature display.

The refrigeration appliance will continue running at normal power.

If you do not turn off the Automatic SuperCool function, it will turn itself off automatically after approx. 6 hours. The appliance will then run at normal power again.

Tip: To save energy, the Automatic SuperCool function can be turned off once food and drinks are sufficiently chilled.

Door alarm

The appliance is fitted with a warning system to avoid increased energy consumption if the door is left open.

Door alarm

An alarm will sound if the appliance door has been left open for longer than approx. 2 minutes.

The **Close the door** message also appears on the display.

As soon as the door is closed, the alarm will stop and the message on the display will disappear.

Turning the door alarm off early

If the alarm disturbs you, it can be turned off early.

- Touch the **OK** sensor control in the display.

The alarm stops and the message disappears from the display.

After a certain time the alarm will sound again and the message will reappear in the display until the appliance door is closed.

Adjusting the interior fittings

Removing or moving the door shelves

Only move or remove the door shelves when they are empty.

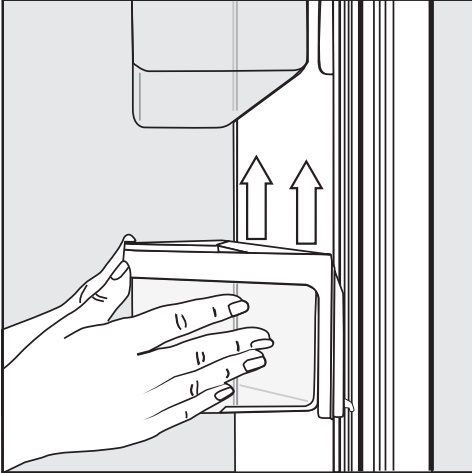

- Hold the shelf on the frame with both hands and lift it slightly so that it can be lifted with the catches on both sides over the guide.
- Remove the shelf or place it in the required position with the catches in the guides at the same height again.
- Make sure that the shelf is straight.

Tip: For the purposes of loading and unloading or cleaning, the clip-in containers in the shelves can be removed from their holders completely.

Removing or moving the shelves

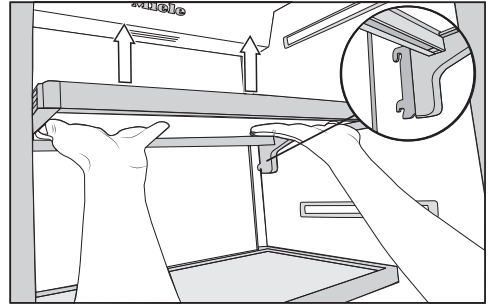

- Hold the shelf on both sides and raise it slightly so that it can be lifted with the catches over the guide at the back.
- Pull the shelf forward.
- Remove the shelf or place it in the required position, with the catches engaged at the back.
- Make sure that the shelf is straight.

Adjusting the interior fittings

Removing the hanging drawer

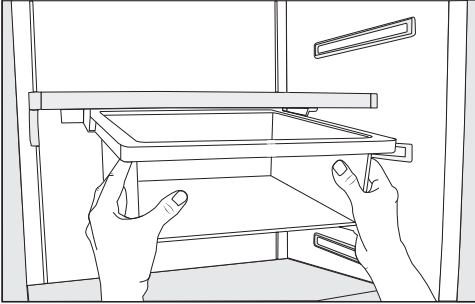

- Pull the hanging drawer straight out to lift it over the pull-out stops on both sides.
- To reinsert the hanging drawer, push it straight into the guide.

The hanging drawer can be moved to the left or right if required.

Moving the hanging drawer

The hanging drawer can be fixed under any shelf in the refrigerator section.

- Pull the hanging drawer out.
- To remove the holder for the hanging drawer, press against the retainers on both sides of the holder from the rear and pull the holder downwards diagonally from the frame.
- To replace the holder, press against the retainers on both sides of the holder from the rear and clamp it into the gap on the frame from below.
- Put the hanging drawer back in.

Tip: Alternatively, you can move the shelf together with the hanging drawer.

Removing compartments from the Fridge Zone

- Pull the compartment out a little bit.

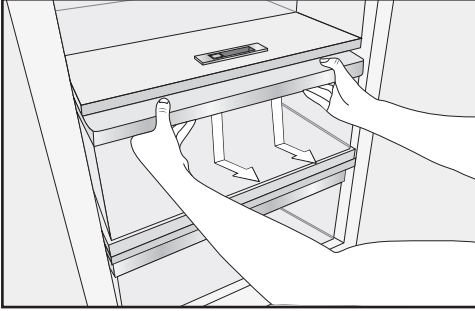

- Using both hands, grasp the compartment frame from below and push the compartment downwards so that the rear end disengages and lifts upwards.
- Pull the compartment forwards to remove it.

Push the runners back in again to avoid damaging them!

Be careful not to wash away the special lubricant in the telescopic runners during cleaning. Wipe the telescopic runners with a damp cloth to clean them.

- To reinsert the compartment, position it on the telescopic runners so that it clicks into place.

Storing food in the refrigerator section

Always observe USDA food safety guidelines.

 Risk of fire from electrical appliances.

Operating electrical devices in the appliance can cause sparks to form. Do not operate any electrical devices inside the appliance.

 Risk of explosion due to flammable mixes of gases.

Electrical components can cause flammable mixes of gases to ignite. Do not store any explosive materials or products containing flammable propellants (e.g., spray cans) in the appliance. The spray cans in question can be identified by the contents printed on the can or by a flame symbol. Electrical components can cause escaping gases to ignite.

 Risk of damage due to greasy or oily foods.

If storing food which contains a lot of fat or oil in the appliance or the door, make sure that it does not come into contact with plastic components as this could cause stress cracks or break the plastic.

Make sure that no fat or oil leaks onto the plastic parts of the appliance.

Different storage zones

Due to natural air circulation, there are different temperature zones in the refrigerator section.

Cold, heavy air sinks to the lowest section of the refrigeration section. Make use of the different zones when placing food in the appliance.

Tip: To allow air to circulate efficiently, do not pack food too closely together in the refrigerator.

If there is insufficient air circulation, the cooling performance will decrease and energy consumption will increase.

Do not cover the fan in the rear wall of the appliance.

Tip: Do not store food in such a way that it touches the rear wall of the refrigerator section as it may freeze to the rear wall.

This appliance has DynamicCooling, which helps to keep an even temperature when the fan is running. When DynamicCooling is turned on, the difference between the various zones is less pronounced.

Storing food in the refrigerator section

Warmest area

The warmest area in the refrigerator section is in the top section of the door. Use this for storing butter so that it remains spreadable and cheese so that it retains its flavor.

Coldest area

The coldest area in the fridge zone is directly above the MasterFresh zone and at the back of the appliance. The temperature in the dry compartment of the MasterFresh zone is even colder.

Use this area in the fridge zone and in the dry compartment of the MasterFresh zone for all delicate and highly perishable food, e.g.:

- fish, meat, poultry
- cold cuts, ready-made meals
- dishes or baked goods containing eggs or cream
- fresh dough, cake mixtures, pizza dough, or pie dough
- raw milk cheese and other raw milk products
- pre-packed vegetables and other fresh food with a best-before date that requires storage at a temperature of at least 39°F (4°C)

Tip: This compartment is ideal for all home-cooked meals as any micro-organisms that may still be present cannot multiply.

Food which is not suitable for storage in the fridge zone

Not all food is suitable for refrigeration at temperatures below 40°F (5°C) because it is sensitive to cold.

Foods which are sensitive to cold include:

- pineapples, avocados, bananas, pomegranates, mangoes, melons, papayas, passion fruit, citrus fruits such as lemons, oranges, mandarins, grapefruits
- fruit (which is not yet ripe)
- eggplant, cucumbers, potatoes, peppers, tomatoes, zucchini
- hard cheeses (e.g., Parmesan)

Storing food in the refrigerator section

Notes on buying food

The freshness of the food when it is first placed in the appliance is the most important factor for how long it stays fresh.

Take into account the use-by date and the correct storage temperature.

Time out of the fridge, e.g., transporting food in a warm car, should be kept to a minimum.

Storing food correctly

Ensure that food stored in the fridge zone is in packaging or covered properly (some exceptions apply in the MasterFresh zone). This will prevent food smells from affecting other food, food from drying out, and also any cross-contamination of bacteria. This is particularly important when storing meat products. Make sure that foods such as raw meat and fish in particular do not come into contact with other food.

By ensuring that the temperature settings are correct and by taking appropriate hygiene measures you can prolong the storage life of your food considerably and avoid food waste.

Fruit and vegetables

Fruit and vegetables can be stored loose in the fruit and vegetable drawer.

Storing food in the MasterFresh zone

MastertFresh zone

The MastertFresh zone provides ideal storage conditions for fruit, vegetables, fish, meat, and dairy products. Food stays fresh considerably longer while retaining both flavor and vitamins.

The MasterFresh zone comprises a humidity-controlled and a dry compartment.

- Depending on the moisture-regulator setting, the **humidity-controlled compartment** is particularly suitable for **storing fruit and vegetables**.
- The **dry compartment** is suitable for **storing perishable foods** such as fish, meat, and dairy products. Any type of food can in fact be stored in this compartment, as long as it is packaged.

	Max. load of the drawers in the MasterFresh zone
K 26x2 Vi/SF	55 lb (25 kg)
K 28x2 Vi/SF	77 lb (35 kg)
K 29x2 Vi/SF	100 lb (45 kg)

Humidity-controlled compartment with moisture adjustment



The moisture released by food in storage is kept within the humidity-controlled compartment drawer. The closer the air humidity in the humidity-controlled compartment is to the humidity content of the food, the crisper and fresher the food remains over a longer period, as the water content of the food is largely retained.

The moisture level greatly depends on the type and quantity of food being stored, if stored unwrapped.

The temperature in the humidity-controlled compartment is approximately equivalent to the temperature in the conventional fridge zone.

Remember that the fresher the food when it is placed in the appliance, the longer it will stay fresh.

Storing food in the MasterFresh zone

The moisture regulator is used to regulate the amount of moisture in the humidity-controlled compartment with settings Δ to $\Delta\Delta\Delta$.

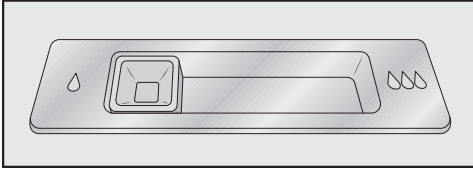

Position of the moisture regulator Δ = slightly increased humidity

Select this setting Δ if you store **very large quantities** of fruits and vegetables in the humidity-controlled compartment. The moisture regulator partially closes the vents in the compartment so that some of the moisture present is retained.

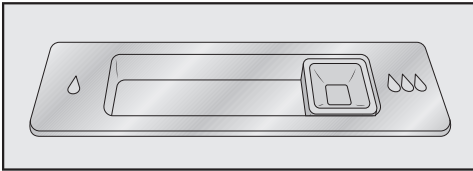

Position of the moisture regulator $\Delta\Delta\Delta$ = increased humidity

Select this setting $\Delta\Delta\Delta$ if you store **small to large quantities** of fruits and vegetables in the humidity-controlled compartment. The moisture regulator closes the vents in the compartment completely so that all of the moisture present is retained.

Tip: If the humidity level is too high and a lot of moisture has collected in the compartment, select the Δ setting. If the quantity of food being stored in this compartment is small, the moisture level may be too low. If you are only storing a small amount of food, wrap it in airtight packaging.

Increased moisture in the humidity-controlled compartment can, in some circumstances, cause a build-up of condensate.

Wipe off any condensate with a cloth.

Regulating the humidity level in the humidity-controlled compartment

- Slide the moisture regulator to the left Δ or right $\Delta\Delta\Delta$ depending on the setting required.

Storing food in the MasterFresh zone

Dry compartment with adjustable temperature



The temperature in the dry compartment is maintained at 30 to 37°F (-1 to 3°C). While lower than the temperature in a standard refrigerator section, this is the optimum temperature range for storing fresh food which is not sensitive to cold.

The deterioration process is decelerated at this temperature range so food can be stored without loss of freshness for considerably longer than in a standard refrigerator and you do not need to shop as often.

However, if you would like it to be warmer or colder, e.g., when storing fish, you can adjust the temperature slightly (see “Selecting additional settings – Adjusting the temperature in the MasterFresh zone (dry compartment) ⚙️↕”).

The humidity level is similar to that in the conventional refrigerator section.

Tip: This compartment is ideal for all home-cooked meals as any micro-organisms that may still be present cannot multiply.

The dry compartment is ideal for storing perishable foods such as:

- dairy products such as yogurt, cheese, cream, etc.
- deli salads
- meat, poultry, and sausage
- fresh fish and shellfish
- Any type of food can in fact be stored in this compartment, as long as it is packaged.

Please note that foods rich in protein deteriorate faster than others.

Shellfish, for example, deteriorates faster than fish, and fish deteriorates faster than meat.

For hygiene reasons, always keep these foods **covered or wrapped** in this compartment.

Take food out of the dry compartment approximately 30 to 60 minutes before using it. The aroma and taste do not fully develop until the food has reached room temperature.

At high room temperatures, delicate food should preferably be kept in the refrigerator section for a period of time.

Storing food in the MasterFresh zone

The following tips may help if you find that food you have stored does not keep well (for example, the food wilts or becomes withered after only a short storage time):

- Only place fresh food in the appliance as the initial condition of the food is crucial to maintaining freshness.
- Clean the MasterFresh zone before storing food in it.
- Very wet food should be dried off before storing it in the humidity-controlled compartment.
- Do not store food which is sensitive to cold in the dry compartment (see “Storing food in the refrigerator section – Food which is not suitable for storage in the refrigerator section”).
- Allocate the appropriate settings to food you wish to store (e.g., humid or dry storage).
- Store food loose in the humidity-controlled compartment.
A high humidity level in the humidity-controlled compartment is achieved by the moisture present in the food being stored.
If the humidity level is not high enough (e.g., too little food is being stored), it can be increased by placing a damp sponge in the drawer.
- If you think that the temperature in the dry compartment is too high or too low, adjust the temperature in the compartment (see “The correct temperature – Temperature range”). If ice crystals start to form at the bottom of the dry compartment, increase the temperature as otherwise the cold temperature will damage the food.
- If too much water collects at the bottom of the humidity-controlled compartment, dry it with a cloth. If necessary, dry food before placing it in the appliance or place a wire rack at the bottom of the humidity-controlled compartment to allow water to drain off.

 **WARNING! DANGER** of injury and damage!

Do not use any mechanical or other types of aids which are not recommended by the manufacturer to accelerate the defrosting process.

Refrigerator section and MasterFresh drawer

The refrigerator section and the MasterFresh drawer defrost automatically.

Condensate and frost can build up on the back wall of the refrigerator section and the MasterFresh drawer while in use. You do not need to remove this, as it will defrost and evaporate automatically with the warmth generated by the appliance.

Cleaning and care

 **WARNING! DANGER** of electric shock!
Unplug the appliance or trip the circuit breaker.

 **WARNING! Fire hazard!**
Do not damage the coolant pipework.

Do not let water get into the electronic or the lighting.

 **Risk of damage due to moisture penetration.**
The steam from a steam cleaner can damage plastic and electrical components.
Do not use a steam cleaner to clean the refrigeration appliance.

The data plate located inside the interior cabinet of the refrigeration appliance must not be removed. It contains information which is required in the event of a service call.

Cleaning agents

To avoid damaging the surfaces of your appliance, **do not** use:

- cleaning agents containing soda, ammonia, acids, or chloride
- cleaning agents containing lime scale remover
- abrasive cleaning agents, such as scouring powder, scouring liquid, or pumice stones
- cleaning agents containing solvents
- stainless steel cleaning agents
- dishwasher cleaner
- oven sprays
- glass cleaner
- hard, abrasive sponges and brushes, such as pot scrubbers
- eraser sponges
- sharp metal scrapers

Cleaning and conditioning agents used in the interior cabinet of the refrigeration appliance must be food safe.

We recommend using lukewarm water and a little liquid dish soap for cleaning.

Before cleaning the appliance

- Turn the appliance off completely by pressing the On/Off switch.
- Take any food out of the appliance and store it in a cool place.
- Take out all other removable parts for cleaning (see “Adjusting the interior fittings”).

Interior and accessories

Clean the appliance regularly, or at least once a month.

Clean up any spills, stains, or food immediately. Do not allow them to dry and stick to the appliance.

- Clean the appliance with a solution of lukewarm water and liquid dish soap. Rinse all parts by hand. Do not wash in a dishwasher.
- After cleaning, wipe with clean water and dry with a soft cloth.
- Leave the door open to air the appliance sufficiently for a short while and to prevent odor buildup.

Aluminum frames

The frames to the shelves inside the appliance and the door shelves are partially made from aluminum.

Aluminum is a dynamic material. The reflection and appearance of aluminum changes in different lights and environments and depending on the angle you observe it from. It is also susceptible to scratching.

The aluminum frames may become discolored or damaged if soiling is left on for too long. Remove any soiling immediately.

Cleaning and care

Appliance front

The appliance front has a special high-quality finish (Clean Touch Steel). This is resistant to soiling and is very easy to clean.

 **Do not use stainless steel cleaning agent** on these surfaces, as it will damage the finish.

Do not use Miele stainless steel conditioning agent on these surfaces, as it will cause noticeable smearing.

If soiling is allowed to sit for any length of time, it may become impossible to remove.

Surfaces may become discolored or damaged.

It is therefore best to remove soiling from the appliance front immediately.

All surfaces are easily scratched. Contact with unsuitable cleaning agents can alter or discolor the surfaces.

See the information on “Cleaning agents” at the beginning of this section.

- Clean the surfaces with a clean sponge and a solution of warm water and liquid dish soap. A clean, damp microfiber cloth without cleaning agent can also be used for cleaning.
- After cleaning, wipe with clean water and dry with a soft cloth.

Cleaning the door seal

 Risk of damage as a result of incorrect cleaning.

If you treat the door seal with oil or grease, it can become porous.

Do not use oil or grease on the door seal.

- The door seals should be cleaned regularly with clean water, and then wiped dry with a soft cloth.

Cleaning the ventilation gaps

A build-up of dust will increase the energy consumption of the appliance.

- The ventilation gaps should be cleaned on a regular basis with a brush or vacuum cleaner (you could use a Miele Vacuum Cleaner dust brush, for example).

Replacing the Active AirClean filters

The Active AirClean filters in the refrigerator section need to be replaced approx. every 6 months.

Change Active AirClean Filter will appear on the display.

- Confirm the message with *OK*.

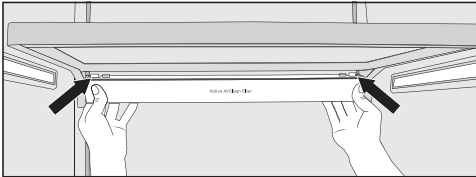

- To remove the holder for the Active AirClean filters, press against the retainers on both sides of the holder from the rear and pull the holder downwards diagonally from the frame.

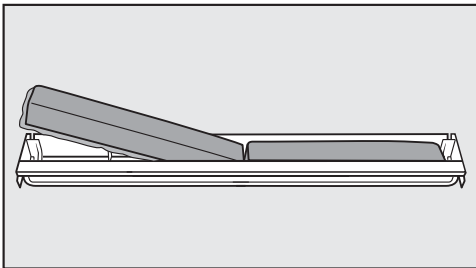

- Remove the used Active AirClean filters and place the new Active AirClean filters with the surrounding edge pointing downwards in the holder.
- To replace the holder, press against the retainers on both sides of the holder from the rear and clamp it into the gap on the frame from below.

The holder can be fixed under any shelf in the refrigerator section.

Once the Active AirClean filters have been replaced, the Active AirClean filter display  must be reset using Settings mode  on the display (see “Selecting additional settings – Resetting the Display Active AirClean Filter ”).

New Active AirClean filters (both with and without a holder) can be obtained from Miele Service, your local dealer, or via the Miele website.

After cleaning

- Replace all shelves and accessories in the appliance.
- Switch the appliance back on.
- Switch on the SuperCool function for a while so that the refrigerator section can cool down quickly.
- Place food back in the appliance and close the door.

Frequently Asked Questions

With the help of the following guide minor faults in the performance of the machine, some of which may result from incorrect operation, can be remedied without contacting the Service Department.

This guide may help you to find the reason for the fault, and how to correct it.





To prevent cold from escaping, open the appliance doors as little as possible until the fault has been corrected.

Problem	Possible cause and solution
If you are concerned that your appliance is not working properly, you can perform a Self Test. Your appliance will be checked for any faults or malfunctions.	Any errors identified during the Self Test are shown on the display. <ul style="list-style-type: none">■ Perform a Self Test (see “Additional settings”, section “Performing a Self Test <input checked="" type="checkbox"/>”).■ Contact Miele Service and inform them of the error message(s) on the display.
The appliance is not getting cold and the interior lighting does not come on when the appliance door is opened.	The appliance has not been turned on. <ul style="list-style-type: none">■ Turn the appliance on. The temperature appears in the display.
	The plug is not properly plugged into the electrical outlet. <ul style="list-style-type: none">■ Insert the plug into the outlet.
	The fuse has tripped. There could be a fault with the appliance, the household electrical wiring, or another appliance. <ul style="list-style-type: none">■ Contact a technician or the Miele Service department.

Frequently Asked Questions











Problem	Possible cause and solution
<p>The compressor is turning on more frequently and for longer periods of time; the temperature in the refrigeration appliance is too low.</p>	<p>The ventilation gaps in the cabinetry have been covered or become too dusty.</p> <ul style="list-style-type: none"> ■ Do not block the ventilation gaps. ■ Clean the ventilation gaps on a regular basis to remove any dust. <p>The appliance door has been opened too frequently, or a large number of bottles have been put inside the unit all at once.</p> <ul style="list-style-type: none"> ■ Only open the appliance door when necessary and for as short a time as possible. <p>After a while, the temperature will return to normal by itself.</p> <p>The appliance door is not properly closed.</p> <ul style="list-style-type: none"> ■ Close the door. <p>After a while, the temperature will return to normal by itself.</p> <p>The ambient temperature is too high. The higher the ambient temperature, the longer the compressor has to run.</p> <ul style="list-style-type: none"> ■ See the information in the section on “Installation – Installation location”. <p>The refrigeration appliance was not properly installed in the building-in niche.</p> <ul style="list-style-type: none"> ■ See the information in “Installation – Installing the refrigeration appliance”.
<p>The compressor is turning on more frequently and for longer periods of time; the temperature in the appliance is too low.</p>	<p>The temperature setting is too low.</p> <ul style="list-style-type: none"> ■ Correct the temperature setting. <p>The SuperCool function is still turned on.</p> <ul style="list-style-type: none"> ■ To save energy, you can turn SuperCool off early yourself.
<p>The compressor comes on less and less often and for shorter periods of time. The temperature in the appliance rises.</p>	<p>This is not a fault. The temperature is too high.</p> <ul style="list-style-type: none"> ■ Correct the temperature setting. ■ Check the temperature again after 24 hours.

Frequently Asked Questions

Problem	Possible cause and solution
The compressor runs continuously.	Not a fault. To save energy, the compressor runs at a lower speed when less cooling is required. This increases the compressor run time.
An alarm sounds.	The appliance door has been open for longer than 3 minutes. <ul style="list-style-type: none"> ■ Close the appliance door.
No alarm sounds despite the appliance door being open.	You have switched off the audible signal. <ul style="list-style-type: none"> ■ Switch the audible signal back on using Settings mode .
	The Sabbath Mode  function is switched on: the temperature display is dark and the  symbol is shown on the display. <ul style="list-style-type: none"> ■ You can switch off Sabbath mode at any time (see “Selecting additional settings – Switching Sabbath Mode  on or off”).
The appliance door cannot be opened.	The Pull2Open Door Assistant is switched on but the appliance has a handle-free cabinet front. <ul style="list-style-type: none"> ■ For handle-free cabinet fronts, switch on the Push2Open Door Assistant (see “Switching on the Door Assistant” in “Selecting additional settings”).
The appliance door cannot be opened when Sabbath Mode  is switched on.	The Push2Open Door Assistant is switched on at the same time as Sabbath Mode. <ul style="list-style-type: none"> ■ When Sabbath Mode is switched on, the Door Assistant is deactivated. ■ Pull the appliance door open from below or from the side.





Frequently Asked Questions

Messages in the display

Message	Possible cause and solution
<p>The warning sounds and the message  appears on the display.</p>	<p>The appliance door is open.</p> <ul style="list-style-type: none"> ■ Close the appliance door. ■ If you wish to turn the alarm off early, touch the sensor control <i>OK</i> on the display. <p>The alarm will stop.</p>
<p>The temperature display is dark and the  symbol is shown on the display.</p>	<p>The Sabbath Mode  function is switched on. The interior lighting is switched off and the refrigeration appliance is cooling down.</p> <ul style="list-style-type: none"> ■ You can switch off Sabbath mode at any time (see “Selecting additional settings – Switching Sabbath Mode  on or off”).
<p>“F Please contact Miele Technical Service.” appears in the display and an alarm sounds.</p>	<p>There is a fault.</p> <ul style="list-style-type: none"> ■ Make a note of the fault message if necessary. ■ Contact Miele Service. ■ To turn the alarm off, touch the  symbol. <p>The error message does not disappear from the display until the error has been rectified.</p>
	<p>The voltage level is too high/low.</p> <ul style="list-style-type: none"> ■ Observe the connection data under “Electrical connections”. ■ Contact Miele Service if necessary. ■ To turn the alarm off, touch the  symbol. <p>The error message does not disappear from the display until the error has been rectified.</p>
<p> is shown in the display. The machine does not get cold, but the machine controls are working.</p>	<p>Demo Mode  is switched on. Demo mode allows the appliance to be presented in the showroom without the cooling system being turned on. Do not activate this setting for domestic use.</p> <ul style="list-style-type: none"> ■ Switch off Demo mode  (see “Selecting additional settings”, section “Switching off Demo Mode ”).

Frequently Asked Questions

The interior lighting is not working.

Problem	Possible cause and solution
The interior lighting is not working.	<p>The refrigeration appliance has not been turned on.</p> <ul style="list-style-type: none">■ Turn the refrigeration appliance on.
	<p>The Sabbath Mode function is switched on: the temperature display is dark and the  symbol is shown on the display.</p> <ul style="list-style-type: none">■ You can switch off Sabbath Mode at any time via the Settings mode .
	<p>There is a fault.</p> <div data-bbox="404 544 1038 799" style="border: 1px solid gray; padding: 5px;"><p> Risk of electric shock due to exposed, live electrical components.</p><p>When removing the lighting cover, there is a risk of coming into contact with live electrical components.</p><p>Do not remove the lighting cover. The LED lighting may only be repaired or replaced by Miele Service.</p></div> <div data-bbox="404 810 1038 1038" style="border: 1px solid gray; padding: 5px;"><p> Risk of injury from LED lighting.</p><p>This lighting corresponds to risk group RG 2. If the cover is defective, there is a risk of eye injury.</p><p>If the lighting cover is defective, do not look from a close range directly into the lighting with optical instruments (e.g., magnifying glass or similar).</p></div> <ul style="list-style-type: none">■ Contact Miele Service.

Causes of noises

Normal noises	Cause
Brrrrr...	A humming noise is made by the motor (compressor). This noise can get louder for brief periods when the motor switches on.
Blub, blub...	A gurgling noise can be heard when the coolant circulates through the pipes.
Click...	Clicking sounds occur whenever the thermostat switches the motor on or off.
Crack...	A cracking sound can be heard when materials expand inside the appliance.

Please bear in mind that a certain amount of noise is unavoidable (from the compressor and the coolant circulating through the system).

Noises	Cause and solution
Rattling, clinking	The appliance is uneven. Realign the appliance using a level by raising or lowering the adjustable feet underneath the refrigeration appliance.
	The appliance is touching another machine or piece of cabinetry. Move it away.
	Drawers, baskets, or shelves are jiggling or are stuck. Check all removable parts and reinsert them correctly if required.
	Bottles or containers are touching each other. Separate them a little.

Customer Service

Contact in the event of a fault

In the event of a fault which you cannot remedy yourself, please contact your Miele dealer or Miele Customer Service.

You can book a Miele Service Call online at www.miele.com/service.

Contact information for Miele Customer Service can be found at the end of this document.

Please quote the model identifier and serial number of your appliance (SN) when contacting Miele Customer Service. Both pieces of information can be found on the data plate.

You will find the data plate inside your appliance.

Appliance warranty and product registration

You can register your product and/or view the manufacturer's warranty terms and conditions for Miele appliances and vacuum cleaners at www.mieleusa.com.

Declaration of conformity

Frequency range	2.412 GHz – 2.462 GHz
-----------------	--------------------------

Maximum transmitting power	< 100 mW
----------------------------	----------

Copyrights and licenses

Miele uses their own and third party software which is not subject to any so-called open source license for the operation and control of the device/appliance. This software/these software components are protected by copyright. The copyright powers of Miele and third parties have to be respected.

Furthermore, this device/appliance contains software components which are distributed under open source license conditions. Please refer to the document “Open Source Information and Licenses” for the Open Source components contained therein, together with the corresponding copyright notices, copies of the licensing conditions valid at the time, and any further information. The liability and warranty provisions of the open source licensing conditions as stated therein apply only in relation to the respective rights holders.

In particular, the device/appliance contains software components licensed by the copyright holders under the GNU General Public License, Version 2, or the GNU Lesser General Public License, Version 2.1. For a period of at least 3 years from the date of purchase or delivery of the device/appliance respectively, Miele offers to provide you or third parties with a machine-readable copy of the source code of the Open Source components contained in the device/appliance and licensed under the terms of the GNU General Public License, Version 2, or the GNU Lesser General Public License, Version 2.1, on a data carrier (CD-ROM, DVD or USB stick). Please contact us via e-mail (info@miele.com) or the below postal address and state the product name, the serial number and the date of purchase to obtain this source code.

Miele & Cie. KG
Open Source
GTZ/TIM
Carl-Miele-Straße 29
33332 Gütersloh

Please note the limited warranty in favor of the rights holders under the terms of the GNU General Public License, Version 2, and the GNU Lesser General Public License, Version 2.1:

This program is distributed in the hope that it will be useful, but WITHOUT ANY WARRANTY, without even the implied warranty of MERCHANTABILITY of FITNESS FOR A PARTICULAR PURPOSE. See the GNU General Public License and GNU Lesser General Public License for more details.

**Please have the model and serial number
of your appliance available when
contacting Customer Service.**

U.S.A.

Miele, Inc.

National Headquarters

9 Independence Way
Princeton, NJ 08540

Customer Service & Support

Phone: 888-99-MIELE(64353)
info@mieleusa.com
www.mieleusa.com

International Headquarters

Miele & Cie. KG
Carl-Miele-Straße 29
33332 Gütersloh
Germany

Canada

**Importer
Miele Limited**

Headquarters and Miele Centre

161 Four Valley Drive
Vaughan, ON L4K 4V8
www.miele.ca

Customer Care Centre

Phone: 800-565-6435
905-532-2272
customercare@miele.ca

K 2602 SF, K 2802 SF, K 2812 SF, K 2902 SF, K 2912 SF