



Microwave Oven

Safety Information 2-4

Operating Instructions

Oven Features 5, 6

Power Levels..... 7

Time Features..... 7-10

Automatic Features 11

Sensor Features.....12, 13

Other Features14, 15

Microwave Terms 16

Care and Cleaning16, 17

Troubleshooting Tips 18

Things That Are Normal 18

Consumer Support

Warranty 19

Consumer SupportBack Cover

Owner's Manual

JES2251

Write the model and serial numbers here:

Model # _____

Serial # _____

You can find them on a label inside the oven.

IMPORTANT SAFETY INSTRUCTIONS.

READ ALL INSTRUCTIONS BEFORE USING.

SAFETY INFORMATION

 This is the safety alert symbol. This symbol alerts you to potential hazards that can kill or hurt you and others. All safety messages will follow the safety alert symbol and the word “DANGER”, “WARNING”, or “CAUTION”. These words are defined as:

 **DANGER** Indicates a hazardous situation which, if not avoided, **will** result in death or serious injury.

 **WARNING** Indicates a hazardous situation which, if not avoided, **could** result in death or serious injury.

 **CAUTION** Indicates a hazardous situation which, if not avoided, **could** result in minor or moderate injury.

When using electrical appliances basic safety precautions should be followed, including the following:

 **WARNING** *To reduce risk of burns, electric shock, fire, personal injury or exposure to excessive microwave energy.*

- Read and follow the specific precautions in the PRECAUTIONS TO AVOID POSSIBLE EXPOSURE TO EXCESSIVE MICROWAVE ENERGY section on page 4.
- Use this appliance only for its intended use as described in this manual. Do not use corrosive chemicals or vapors in this appliance. This microwave oven is specifically designed to heat, dry or cook food, and is not intended for laboratory or industrial use.
- This microwave should be serviced only by qualified service personnel. Contact nearest authorized service facility for examination, repair, or adjustment.

INSTALLATION

- Install or locate this appliance only in accordance with the provided installation instructions.
- This appliance must be grounded. Connect only to a properly grounded outlet. See the GROUNDING INSTRUCTIONS section on page 3.
- Do not operate this appliance if it has a damaged power cord or plug, if it is not working properly, or if it has been damaged or dropped.
- Keep power cord away from heated surfaces.
- Do not let power cord hang over edge of table or counter.
- Do not immerse power cord or plug in water.
- Do not block or cover any openings on the appliance.
- Do not store this appliance outdoors. Do not use this product near water—for example, in a wet basement, near a swimming pool, near a sink or in similar location.
- Do not mount this appliance over a sink.

TO REDUCE THE RISK OF FIRE IN THE OVEN CAVITY

- Do not overcook food. Carefully attend appliance when paper, plastic or other combustible materials are placed inside the oven while cooking.
- Remove wire twist-ties and metal handles from paper or plastic containers before placing them in the oven.
- Do not store any materials, other than our recommended accessories, in this oven when not in use. Do not leave paper products, cooking utensils or food in the cavity when not in use. Microwave rack should be removed from oven when not in use.
- If materials inside the oven ignite, keep the oven door closed, turn the oven off and disconnect the power cord, or shut off power at the fuse or circuit breaker panel.
- Do not operate the microwave without food in the oven.

TO REDUCE THE RISK OF BURNS

- Be careful when opening containers of hot food. Use pot holders and direct steam away from face and hands.
- Vent, pierce, or slit containers, pouches, or plastic bags to prevent build-up of pressure.
- Be careful when touching the turntable, door, or walls of the oven which may become hot during use.
- Liquids and certain foods heated in the microwave oven can present a risk of burn when removing them from the microwave. The potential for a burn is greater in young children, who should not be allowed to remove hot items from the microwave.

OPERATING AND CLEANING

- As with any appliance, close supervision is necessary when used by children.
- Do not store anything directly on top of the microwave surface when the microwave oven is in operation.
- Oversized food or oversized metal cookware should not be used in a microwave/convection oven because they increase the risk of electric shock and could cause a fire.
- Do not clean with metal scouring pads. Pieces can burn off the pad and touch electrical parts involving risk of electric shock.
- Do not use paper products in oven when appliance is operated in any cooking mode except microwave only.

SAVE THESE INSTRUCTIONS

IMPORTANT SAFETY INSTRUCTIONS.

READ ALL INSTRUCTIONS BEFORE USING.

OPERATING AND CLEANING (Continued)

- Some products such as whole eggs and sealed containers—for example, closed jars—are able to explode and should not be heated in this microwave oven.
- Do not cover any part of the microwave with metal foil. This will cause overheating of the microwave.
- Cook meat and poultry thoroughly—meat to at least an INTERNAL temperature of 160°F and poultry to at least an INTERNAL temperature of 180°F. Cooking to these temperatures usually protects against foodborne illness.
- Make sure all cookware used in your microwave oven is suitable for microwaving. Most glass casseroles, cooking dishes, measuring cups, custard cups, pottery or china dinnerware which does not have metallic trim or glaze with a metallic sheen can be used in compliance with cookware manufacturers' recommendations.
- It is important to keep the area clean where the door seals against the microwave. Use only mild, nonabrasive detergents applied with a clean sponge or soft cloth. Rinse well.

SUPERHEATED WATER

- Liquids, such as water, coffee, or tea, are able to be overheated beyond the boiling point without appearing to be boiling. Visible bubbling or boiling when the container is removed from the microwave oven is not always present. *THIS COULD RESULT IN VERY HOT LIQUIDS SUDDENLY BOILING OVER WHEN THE CONTAINER IS DISTURBED OR A SPOON OR OTHER UTENSIL IS INSERTED INTO THE LIQUID.*

To reduce the risk of injury to persons:

- Do not overheat the liquid.
- Stir the liquid both before and halfway through heating it.
- Do not use straight-sided containers with narrow necks.
- After heating, allow the container to stand in the microwave oven for a short time before removing the container.
- Use extreme care when inserting a spoon or other utensil into the container.

GROUNDING INSTRUCTIONS



WARNING

To prevent risk of electric shock, follow these instructions:

- Plug microwave into a grounded 3-prong outlet.
- Do not remove the ground prong or use an adapter.
- Do not use an extension cord.

Improper use of the grounding plug can result in a risk of electric shock.

This appliance must be grounded. In the event of an electrical short circuit, grounding reduces the risk of electric shock by providing an escape wire for the electric current.

This appliance is equipped with a power cord having a grounding wire with a grounding plug. The plug must be plugged into an outlet that is properly installed and grounded.

Consult a qualified electrician or service technician if the grounding instructions are not completely understood, or if doubt exists as to whether the appliance is properly grounded.

A short power-supply is provided to reduce the risks resulting from becoming entangled or tripping over a longer cord. Do not use an extension cord with this appliance. If the power cord is too short, have a qualified electrician or service technician install an outlet near the appliance.

PACEMAKERS

Most pacemakers are shielded from interference from electronic products, including microwaves. However, patients with pacemakers may wish to consult their physicians if they have concerns.

SAVE THESE INSTRUCTIONS

IMPORTANT SAFETY INSTRUCTIONS. READ ALL INSTRUCTIONS BEFORE USING.

PRECAUTIONS TO AVOID POSSIBLE EXPOSURE TO EXCESSIVE MICROWAVE ENERGY

- **Do Not Attempt** to operate this oven with the door open since open-door operation can result in harmful exposure to microwave energy. It is important not to defeat or tamper with the safety interlocks.
- **Do Not Place** any object between the oven front face and the door or allow soil or cleaner residue to accumulate on sealing surfaces.
- **Do Not Operate** the oven if it is damaged. It is particularly important that the oven door close properly and that there is no damage to the:
 - (1) door (bent)
 - (2) hinges and latches (broken or loosened)
 - (3) door seals and sealing surfaces
- **The Oven Should Not** be adjusted or repaired by anyone except properly qualified service personnel. Contact nearest authorized service facility for examination, repair or adjustment.

READ AND FOLLOW THIS SAFETY INFORMATION CAREFULLY.

SAVE THESE INSTRUCTIONS

FEDERAL COMMUNICATIONS COMMISSION (U.S.A.) RADIO FREQUENCY INTERFERENCE STATEMENT

This equipment generates and uses ISM frequency energy and if not installed and used properly, that is in strict accordance with the manufacturer's instructions, may cause interference to radio and television reception. It has been type tested and found to comply with limits for an ISM Equipment pursuant to part 18 of FCC Rules, which are designed to provide reasonable protection against such interference in a residential installation. However, there is no guarantee that interference will not occur in a particular installation. If this equipment does cause interference to radio or television reception, which can be determined by tuning the equipment off and on, the user is encouraged to try to correct the interference by one or more of the following:

- Reorient the receiving antenna of radio or television.
- Relocate the Microwave oven with respect to the receiver.
- Move the microwave oven away from the receiver.
- Plug the microwave oven into a different outlet so that microwave oven and receiver are on different branch circuits.

The manufacturer is not responsible for any radio or TV interference cause by unauthorized modification to this microwave oven. It is the responsibility of the user to correct such interference.

About the features of your microwave oven.

Throughout this manual, features and appearance may vary from your model.

1200 Watts

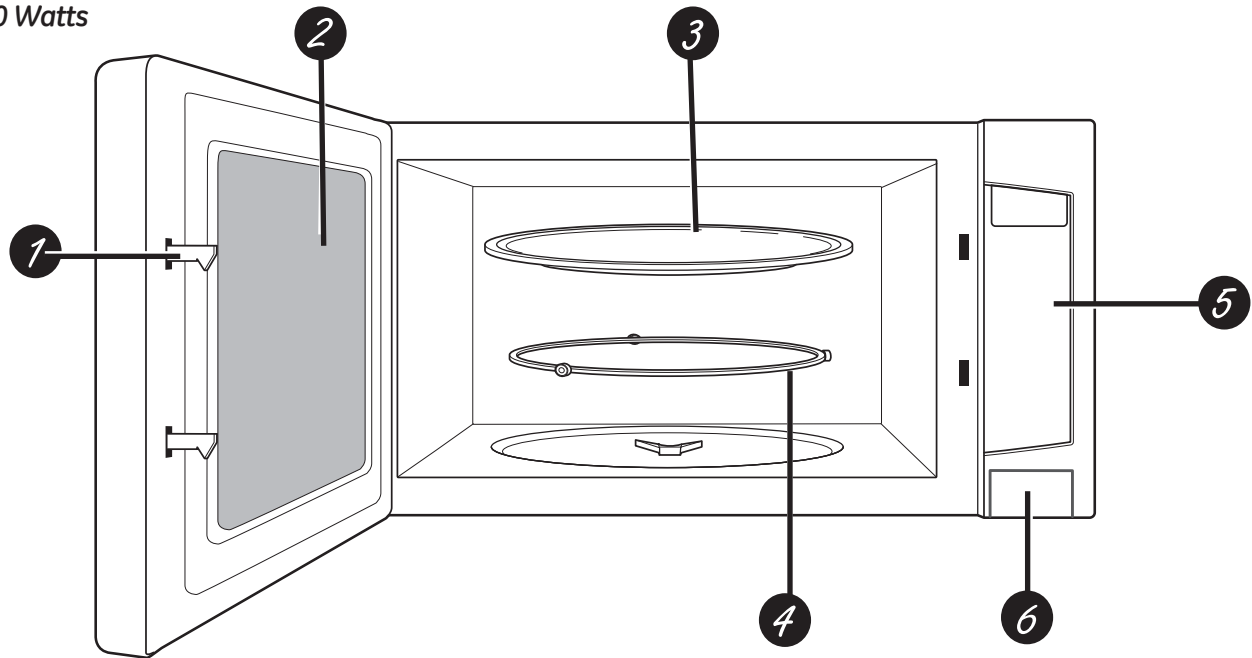

Features of the Oven

- 1** **Door Latches.**
- 2** **Window with Metal Shield.** Screen allows cooking to be viewed while keeping microwaves confined in the oven.
- 3** **Removable Turntable.** Turntable and support **must** be in place when using the oven. The turntable may be removed for cleaning.
- 4** **Removable Turntable Support.** The roller ring support must be in place when using the oven.
- 5** **Touch Control Panel Display.**
- 6** **Door Latch Release.** Press latch release to open door.

NOTE: Rating plate, oven vent(s) and oven light are located on the inside walls of the microwave oven.

About the features of your microwave oven.

You can microwave by time, with the sensor features or with the auto feature.

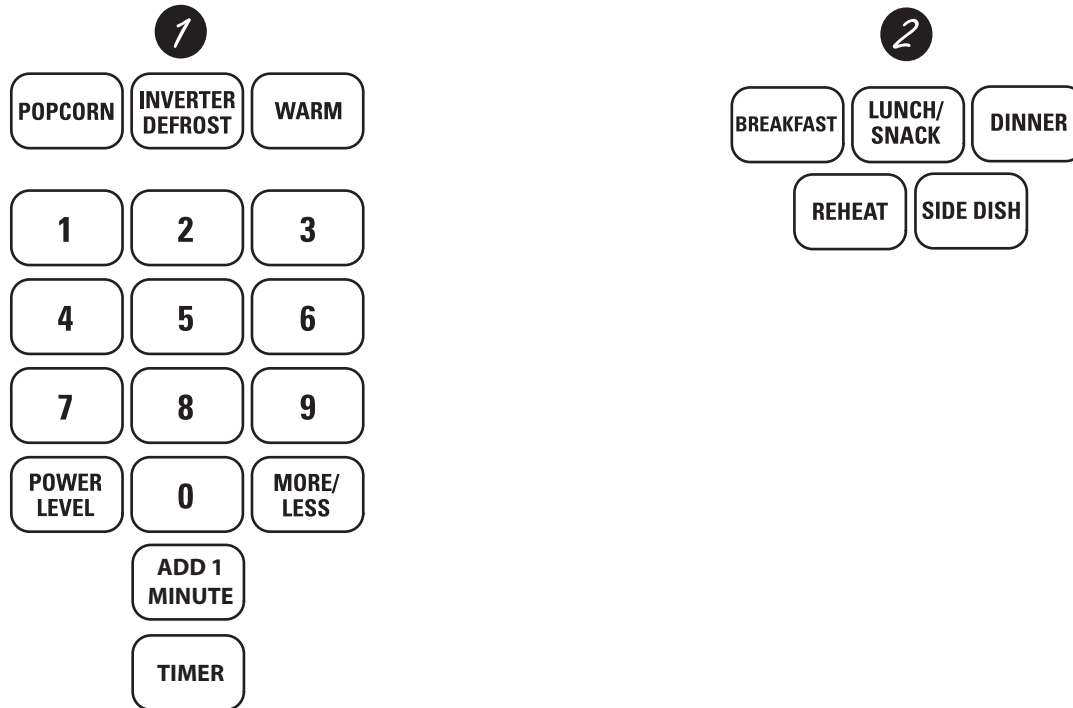

Cooking Controls

1 Time Features

Press	Enter	Options
Number Pads	Amount of cooking time	
WARM	Amount of warming time	
POPCORN	Press START	3.5 oz., 3.0 oz. or 1.75 oz. More/Less time
Press once, twice or three times		
POWER LEVEL	Amount of cooking time	
Press one to ten times		
INVERTER DEFROST	Food weight up to 6 lbs.	
ADD 1 MINUTE	Press START	
Press one to ten times		
TIMER	Amount of time	

2 Sensor Features

Press	Enter	Options
DINNER	Press START	More/Less time
BREAKFAST	Press START	More/Less time
LUNCH/SNACK	Press START	More/Less time
SIDE DISH	Press START	More/Less time
Press until food appears in display		
REHEAT	Press START	More/Less time

About changing the power level.



Power Level

Select the power level before entering the cooking time. Press **POWER LEVEL** until the desired power level appears in the display.

Press	Power Level
Once	P10 (High)
Twice	P9
3 times	P8
4 times	P7 (Med.-High)
5 times	P6 (Medium)
6 times	P5
7 times	P4
8 times	P3 (Med.-Low) Defrost
9 times	P2
10 times	P1 (Low)

The maximum programmable cooking time at Power Level 10 is 30 minutes. For other Power Levels, the maximum cooking time is 99 minutes and 99 seconds.

Variable power levels add flexibility to microwave cooking. Power Level 7 (**P7**) is microwave energy at 70% of full power. Power Level 3 (**P3**) is microwave energy at 30% of full power. Most cooking will be done on High (**P10**), which gives you 100% of power.

A high setting (**P10**) will cook faster but food may need more frequent stirring, rotating or turning over. A lower setting will cook more evenly and need less stirring or rotating of the food.

Here are some examples of uses for various power levels:

- P10** High for fish, bacon, vegetables, boiling liquids, etc.
- P7** Medium high for gentle cooking of meat and poultry, baking casseroles and reheating
- P5** Medium for slow cooking and tenderizing for stews and less tender cuts of meat

P2 or Low for defrosting
P3

About the time features.

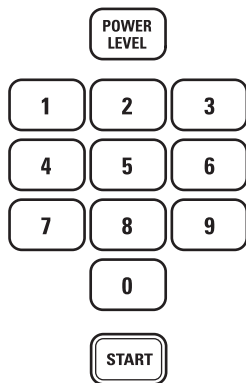

To Cook by Time

The microwave is automatically set for Power Level 10 (High). It can be changed for cooking flexibility. At Power Level 10, the maximum programmable cooking time is 30 minutes. Maximum cooking times for Power Levels 1 to 9 are 99 minutes and 99 seconds.

- 1** Press **POWER LEVEL** until the desired power level appears in the display window. Skip this step if you wish to use Power Level 10.
- 2** Enter the cooking time using the number pads.
- 3** Press **START**.

You may open the door during the cooking time to check the food. Close the door and press **START** to resume cooking. The microwave will beep 5 times to signal that the cooking time is completed.

Stage Cooking

You can program up to 5 cooking stages:

- 1** Press **POWER LEVEL** until the desired power level appears in the display window.
- 2** Set the cooking time using the number pads.
- 3** Repeat steps 1 and 2. (For additional stages, repeat steps 1 and 2).
- 4** Press **START**.

Each cooking stage time will count down in the display. The microwave will beep 2 times between each stage. At the end of the sequence, the microwave will beep 5 times.

About the time features.

Cooking Guide for Timed Cooking

Use High power level (P10) unless otherwise noted.

Vegetable	Amount	Time	Comments
Asparagus (fresh spears)	1 lb.	5 to 8 min., Med-High (P7)	In 1½-qt. casserole, place 1/4 cup water.
(frozen spears)	10-oz. package	4 to 7 min.	In 1-qt. casserole.
Beans (fresh green)	1 lb. cut in half	10 to 14 min.	In 1½-qt. casserole, place 1/2 cup water.
(frozen green)	10-oz. package	4 to 8 min.	In 1-qt. casserole, place 2 tablespoons water.
(frozen lima)	10-oz. package	4 to 8 min.	In 1-qt. casserole, place 1/4 cup water.
Beets (fresh, whole)	1 bunch	16 to 21 min.	In 2-qt. casserole, place 1/2 cup water.
Broccoli (fresh cut)	1 bunch (1¼ to 1½ lbs.)	5 to 9 min.	In 2-qt. casserole, place 1/2 cup water.
(fresh spears)	1 bunch (1¼ to 1½ lbs.)	7 to 10 min.	In 2-qt. casserole, place 1/4 cup water.
(frozen, chopped)	10-oz. package	4 to 7 min.	In 1-qt. casserole.
(frozen spears)	10-oz. package	4 to 7 min.	In 1-qt. casserole, place 3 tablespoons water.
Cabbage (fresh)	1 medium head (about 2 lbs.)	6 to 9 min.	In 1½- or 2-qt. casserole, place 1/4 cup water.
(wedges)		5 to 9 min.	In 2- or 3-qt. casserole, place 1/4 cup water.
Carrots (fresh, sliced)	1 lb.	4 to 8 min.	In 1½-qt. casserole, place 1/4 cup water.
(frozen)	10-oz. package	3 to 7 min.	In 1-qt. casserole, place 2 tablespoons water.
Cauliflower (flowerets)	1 medium head	7 to 10 min.	In 2-qt. casserole, place 1/2 cup water.
(fresh, whole)	1 medium head	7 to 14 min.	In 2-qt. casserole, place 1/2 cup water.
(frozen)	10-oz. package	3 to 7 min.	In 1-qt. casserole, place 2 tablespoons water.
Corn (frozen kernel)	10-oz. package	2 to 6 min.	In 1-qt. casserole, place 2 tablespoons water.
Corn on the cob (fresh)	1 to 5 ears	1¼ to 4 min. per ear	In 2-qt. glass baking dish, place corn. If corn is in husk, use no water; if corn has been husked, add 1/4 cup water. Rearrange after half of time.
(frozen)	1 ear 2 to 6 ears	3 to 6 min. 2 to 3 min. per ear	Place in 2-qt. oblong glass baking dish. Cover with vented plastic wrap. Rearrange after half of time.
Mixed vegetables (frozen)	10-oz. package	2 to 6 min.	In 1-qt. casserole, place 3 tablespoons water.
Peas (fresh, shelled)	2 lbs. unshelled	7 to 9 min.	In 1-qt. casserole, place 1/4 cup water.
(frozen)	10-oz. package	2 to 6 min.	In 1-qt. casserole, place 2 tablespoons water.
Potatoes (fresh, cubed, white)	4 potatoes (6 to 8 oz. each)	9 to 11 min.	Peel and cut into 1-inch cubes. Place in 2-qt. casserole with 1/2 cup water. Stir after half of time.
(fresh, whole, sweet or white)	1 (6 to 8 oz.)	2 to 4 min.	Pierce with cooking fork. Place in the oven, 1≤ apart, in circular arrangement. Let stand 5 minutes.
Spinach (fresh)	10 to 16 oz.	3 to 6 min.	In 2-qt. casserole, place washed spinach.
(frozen, chopped and leaf)	10-oz. package	3 to 6 min.	In 1-qt. casserole, place 3 tablespoons water.
Squash (fresh, summer, and yellow)	1 lb. sliced	3 to 5 min.	In 1½-qt. casserole, place 1/4 cup water.
(winter, acorn or butternut)	1 to 2 squash (about 1 lb. each)	5 to 9 min.	Cut in half and remove fibrous membranes. In 2-qt. glass baking dish, place squash cut-side-down. Turn cut-side-up after 4 minutes.



Add 1 Minute

You can use this feature in two ways:

- Each time the pad is pressed, it will add one minute to the time counting down. Press up to 10 times to add 10 minutes of cooking time.
- It can be used to set one minute of cooking time.

1 Press **ADD 1 MINUTE**, up to 10 times.

2 Press **START**.

The oven will beep 5 times when cooking is completed.

ADD 1 MINUTE only applies to Time Cook, Warm and Timer.



Use only with prepackaged microwave popcorn weighing 1.75 to 3.5 ounces.

Popcorn

To use the **Popcorn** feature:

- 1** Follow package instructions. Place the package of popcorn in the center of the microwave.
- 2** Press **POPCORN**:
Once for 3.5 oz. bag.
Twice for 3.0 oz. bag.
3 times for 1.75 oz. bag.
- 3** Press **START**.

How to Adjust the Popcorn Program to Provide a Shorter or Longer Cook Time

If the brand of popcorn you use consistently overcooks or underpops, you can add or subtract 10 to 20 seconds to the popping time.

Press the **MORE/LESS** pad before the **START** pad:

Once Adds 10 seconds

Twice Adds 20 seconds

3 Times Subtracts 10 seconds

4 Times Subtracts 20 seconds

5 Times Reverts to original setting



Warm

This feature will keep food warm up to 30 minutes after cooking.

This feature can be programmed as a final cooking stage, after one or more cooking times have been entered. It cannot be used in combination with Sensor or Auto features.

1 Press **WARM**.

2 Enter the warming time, up to 30 minutes.

3 Press **START**.

About the time features.

To Soften and Melt

The following are a few examples of how to soften or melt food items using various Power Levels and cooking times.

Brown Sugar

To soften 1 cup of brown sugar, place sugar in a microwave-safe dish with a slice of bread. Cover with lid or plastic wrap.

- 1** Select **POWER LEVEL P10** (High).
- 2** Enter 20 to 30 seconds.
- 3** Press **START**.

Refrigerated Butter

To soften 1 stick (1/4 lb.) of refrigerated butter, remove wrapper and place the butter in a microwave-safe dish.

- 1** Select **POWER LEVEL P2**.
- 2** Enter 1 minute.
- 3** Press **START**.

To melt 1 stick (1/4 lb.) of refrigerated butter, place in a microwave-safe dish. Cover with lid or vented plastic wrap.

- 1** Select **POWER LEVEL P6** (Medium).
- 2** Enter 1 to 1½ minutes.
- 3** Press **START**.

Cream Cheese

To soften 8 oz. of cream cheese, remove wrapper and place the cream cheese in a microwave-safe dish.

- 1** Select **POWER LEVEL P3** (Med.-Low).
- 2** Enter 1 to 2 minutes.
- 3** Press **START**.

Ice Cream

To soften 1 quart of ice cream, place.

- 1** Select **POWER LEVEL P3** (Med.-Low).
- 2** Enter 45 seconds.
- 3** Press **START**.

Check often to prevent melting.

About the automatic features.

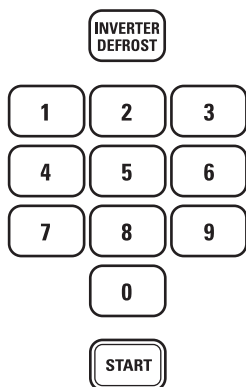

Inverter Defrost

Use **INVERTER DEFROST** for meat, poultry and fish.

INVERTER DEFROST automatically sets the defrosting time and power levels for even defrosting results. Use for meats, poultry and fish weighing up to 6 pounds.

- 1** Press **INVERTER DEFROST**.
- 2** Using the *Conversion Guide* below, enter food weight. For example, press pads **1** and **2** for 1.2 pounds (1 pound, 3 ounces).
- 3** Press **START**.

When the oven beeps two times, **TURN OVER** appears in the display. Turn food over, rearrange foods or remove defrosted meat. Shield warm areas with small pieces of foil.

Conversion Guide

If the weight of food is stated in pounds and ounces, the ounces must be converted to tenths (.1) of a pound.

Weight of Food in Ounces	Enter Food Weight (tenths of a pound)
1-2	.1
3	.2
4-5	.3
6-7	.4
8	.5
9-10	.6
11	.7
12-13	.8
14-15	.9

Defrosting Tips

- Place food in a microwave safe dish.
- Place roasts fat-side down. Place whole poultry breast-side down.
- Drain liquids during defrosting.

Standing Time

After defrosting, most meats should stand 5 minutes to complete defrosting. Large roasts should stand for about 30 minutes.

Standing time can be programmed to count down at the end of the defrost cycle. See the Timer section on page 15 for details.

MORE/LESS

More/Less

Use the **MORE/LESS** pad to adjust Sensor cooking and Popcorn program cooking times.

For Sensor cooking, press the **MORE/LESS** pad:

- Once** Adds approximately 20% more time
- Twice** Subtracts approximately 20% time
- 3 Times** Reverts to original setting

Press **START**.

To adjust Popcorn, press the **MORE/LESS** pad:

- Once** Adds 10 seconds
- Twice** Adds 20 seconds
- 3 Times** Subtracts 10 seconds
- 4 Times** Subtracts 20 seconds
- 5 Times** Reverts to original setting

Press **START**.

About the sensor features.

Humidity Sensor

The **Sensor Features** detect the increasing humidity released during cooking. The oven automatically adjusts the cooking time to various types and amounts of food.

Do not use the Sensor Features twice in succession on the same food portion—it may result in severely overcooked or burnt food. If food is undercooked after the countdown, use the number pads to add more cooking time. Cooking preference varies with individuals. After using the Sensor Reheat or Sensor Cooking pad, you may want to adjust for a different cooking time. The **MORE/LESS** pad allows you to add or subtract 10% to 20% cooking time to the program. See page 11 for details.



Covered



Vented



Dry off dishes so they don't mislead the sensor.

- The proper containers and covers are essential for best sensor cooking.

- Always use microwave-safe containers and cover them with lids or vented plastic wrap. Never use tight sealing plastic containers—they can prevent steam from escaping and cause food to overcook.

- Be sure the outside of the cooking containers and the inside of the microwave oven are dry before placing food in the oven. Beads of moisture turning into steam can mislead the sensor.

REHEAT

NOTE: Do not use this feature twice in succession on the same food portion—it may result in severely overcooked or burnt food.

Reheat

The Reheat feature should be used to heat previously cooked foods, such as a plate of leftovers.

- 1 Place covered food in the oven. Press **REHEAT**.
- 2 Press **START**. The oven beeps 2 times when steam is detected. Time remaining begins to count down in the display window. The oven will beep 5 times at the end of the countdown.

Do not open the oven door until time is counting down. If the door is opened, close it and press **START** immediately.

After removing food from the oven, stir, if possible, to even out the temperature. Reheated foods may have wide variations in temperature. Some areas may be extremely hot.

Some Foods Not Recommended for Use With Reheat

It is best to use Time Cooking for these foods:

- Bread products.
- Foods that must be reheated uncovered.
- Foods that need to be stirred or rotated.
- Foods calling for a dry look or crisp surface after reheating.

After using this feature a few times, you may find that beverages are not hot enough. To reduce time by 20%: Press the **MORE/LESS** pad two times. To add 20% to cooking time: Press the **MORE/LESS** pad one time. Press the **MORE/LESS** pad before the **START** pad.



NOTE: Do not use these features twice in succession on the same food portion—they may result in severely overcooked or burnt food.

Sensor Cooking

Sensor cooking allows you to cook food without setting a time.

Choose the Sensor Cooking feature for your food type.

Always use microwave-safe containers. Cover them with lids or vented plastic wrap. Be careful when removing covers after cooking. To avoid steam burns, remove covers facing away from you.

- 1** Place food in the oven. Press the food pad until the food category appears in the window.
- 2** Press **START**. The oven beeps 2 times when steam is detected. Time remaining begins to count down in the display window. The oven will beep 5 times at the end of the countdown.

Do not open the oven door until time is counting down. If the door is opened, close it and press **START** immediately.

How to Change the Automatic Settings

After using this feature a few times, you may find that food is undercooked or overcooked. You can adjust the cooking time for some foods to suit your personal taste.

To reduce time by 20%:

Press the **MORE/LESS** pad two times.

To add 20% to cooking time:

Press the **MORE/LESS** pad one time.

Press the **MORE/LESS** pad before the **START** pad.”

Sensor Cooking

Pad	Food Type	Amount	Comments
Breakfast	Oatmeal	½ to 1 cup	Place in a serving bowl. Do not cover. Follow package directions.
	Breakfast Sausage	2 to 8 links	Follow package directions for pre-cooked sausage. Arrange in a star pattern.
	Omelet	2 to 4 eggs	Coat a 9-inch pie plate with ½ tsp. melted butter for each egg. Add 1 tsp. milk for each egg. Cook covered with vented plastic wrap. Let stand 2 minutes after cooking. Always use scrambled eggs.
Lunch/ Snack	Soup	1 to 2 cups	Place in serving bowl. Cover with vented plastic wrap. Stir after cooking.
	Frozen Entrees	8 to 32 oz.	Follow package directions. After 2 beeps, stir or rearrange.
	Frozen Pizza	8 oz.	Follow package directions.
	Frozen Pocket Sandwich	1 sandwich (4–5 oz.)	Follow package directions.
Side Dish	Potatoes	4 maximum 6 to 8 oz. each	Pierce skin with a fork, 6 times, evenly spaced. Space potatoes 1 inch apart. Let stand 5 minutes to complete cooking.
	Fresh Vegetables	4 to 16 oz.	Add 1 tbsp. water per ½ cup of vegetables. Cover with vented plastic wrap.
	Frozen Vegetables	6 to 16 oz.	Add 1 tbsp. water per ½ cup of vegetables. Cover with vented plastic wrap. Stir or rearrange after 2 beeps. (Not for vegetables in butter or sauce).
	Canned Vegetables	15 oz.	Do not cover.
	White Rice	½ to 1½ cups	Use hot tap water. Cover with vented plastic wrap. Let stand 5 to 10 minutes before serving.
	Brown Rice	½ to 1½ cups	Use hot tap water. Cover with vented plastic wrap. Let stand 5 to 10 minutes before serving.
Dinner	Frozen Dinners	11 to 16 oz.	Follow package directions. Do not use food packaged in foil trays.
	Pasta	2 to 8 oz.	Use hot tap water. Cover with vented plastic wrap.
	Stew	1 to 2 cups	Cover with vented plastic wrap. Stir after cooking.
	Ground Meat	16 to 32 oz.	Break apart in glass bowl or colander. Cover with vented plastic wrap. Stir after 2 beeps. Re-cover and press START .
	Fish Fillets	4 to 16 oz.	Arrange in a single layer. Cover with vented plastic wrap.

About the other features.

STOP
RESET

Stop/Reset

Use the **STOP/RESET** pad to clear the memory. During cooking, press once to stop the cooking process. Press twice to cancel all cooking instructions.

OPTIONS

Options Features

The **OPTIONS** pad allows you to establish and set preferred non-cooking features. These features include: *Child Lock*, *Word Speed*, and more. See the chart below.

To access and change the various **OPTIONS** features:

- 1** Press **OPTIONS**.
- 2** Press the number of the desired feature, **1** through **9**.
- 3** Select and press the number for the desired setting, **1** or **2**, or **1, 2** or **3**.

Number Pad	Option	Choices (* indicates default setting)
1	LB/KG	1. LB. Weight display in ounces/pounds* 2. KG. Weight display in grams/kilograms
2	WORD SPEED	1. Fast scrolling speed 2. Medium scrolling speed* 3. Low scrolling speed
3	MENU ACTION	1. ON Step-by-step programming instructions displayed 2. OFF Instructions not displayed*
4	CHILD LOCK-OUT	1. ON Oven is locked, will not operate 2. OFF Lock-out cancelled*
5	BEEP ON/OFF	1. ON Beep sound on 2. OFF Beep sound turned off*
6	REMINDER BEEP	1. ON Reminder beep sounds every 15 seconds 2. OFF Reminder beep turned off*
7	DAYLIGHT SAVINGS TIME	1. ON Time of day advances one hour 2. OFF Time returns to original setting*
8	CLOCK ON/OFF	1. ON Time of day is displayed* 2. OFF Time of day is not displayed
9	DEMO MODE	1. ON Oven is In-Store Demo mode 2. OFF Not in Demo mode

Insert Food Reminder

A reminder will show on the display if the user tries to start cooking cycle without placing food inside the microwave oven within 5 minutes prior to starting the cooking cycle.

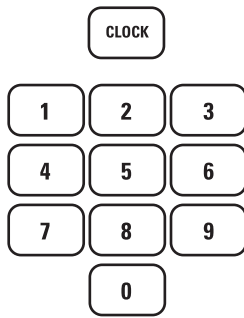

Clock

Press to enter the time of day.

- 1** Press **CLOCK**.
- 2** Enter the time of day.
- 3** Press **CLOCK**.

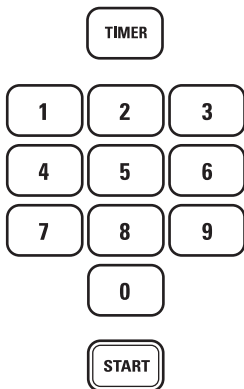

Timer

This feature operates as a kitchen timer. It can also be used to program a delay start or a standing time after cooking is completed.

- 1** Press **TIMER**.
- 2** Enter the amount of time, in minutes and seconds, using the number pads (up to 99 minutes and 99 seconds).
- 3** Press **START**.

Time will count down in the display window. The oven will beep 5 times to alert you when the time is up.

Opening the door will not stop the countdown. The time will continue to count down if the oven door is opened.

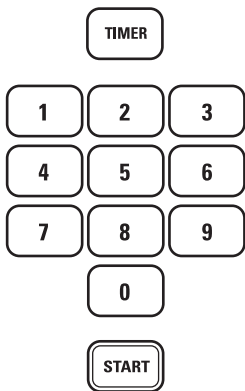

Delay Start

You can program the oven to start at a later time.

- 1** Press **TIMER**.
- 2** Enter the amount of delay time, in minutes and seconds, using the number pads (up to 99 minutes and 99 seconds).
- 3** Press the **POWER LEVEL** pad to set the desired power level. Skip this step for power level 10 (**P10**).

- 4** Enter the desired cooking time using the number pads.
- 5** Press **START**.

The **Delay Start** time will count down. The oven will automatically start at the set time. To cancel the **Delay Start** time, press **STOP/RESET**.

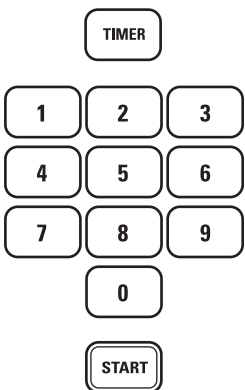

Stand Time

You can program the oven for a standing time after cooking is completed.

- 1** Press the **POWER LEVEL** pad to set the desired power level. Skip this step for power level 10 (**P10**).
- 2** Enter the desired cooking time using the number pads.
- 3** Press **TIMER**.

- 4** Enter the amount of stand time, up to 99 minutes and 99 seconds.
- 5** Press **START**.

The **Stand Time** will count down. When each stage finishes, the oven will beep 2 times. At the end of the program, the oven will beep 5 times. To cancel the **Stand Time**, press **STOP/RESET**.

Microwave terms.

Term	Definition
Arcing	Arcing is the microwave term for sparks in the oven. Arcing is caused by: <ul style="list-style-type: none">■ metal or foil touching the side of the oven.■ foil that is not molded to food (upturned edges act like antennas).■ metal such as twist-ties, poultry pins, gold-rimmed dishes.■ recycled paper towels containing small metal pieces.
Covering	Covers hold in moisture, allow for more even heating and reduce cooking time. Venting plastic wrap or covering with wax paper allows excess steam to escape.
Shielding	In a regular oven, you shield chicken breasts or baked foods to prevent over-browning. When microwaving, you use small strips of foil to shield thin parts, such as the tips of wings and legs on poultry, which would cook before larger parts.
Standing Time	When you cook with regular ovens, foods such as roasts or cakes are allowed to stand to finish cooking or to set. Standing time is especially important in microwave cooking. Note that a microwaved cake is not placed on a cooling rack.
Venting	After covering a dish with plastic wrap, you vent the plastic wrap by turning back one corner so excess steam can escape.

Care and cleaning of the microwave oven.



Helpful Hints

An occasional thorough wiping with a solution of baking soda and water keeps the inside fresh.

Unplug the cord before cleaning any part of this oven.

How to Clean the Inside

Walls, Floor, Inside Window, Metal and Plastic Parts on the Door

Some spatters can be removed with a paper towel; others may require a damp cloth. Remove greasy spatters with a sudsy cloth, then rinse with a damp cloth. Do not use abrasive cleaners or sharp utensils on oven walls.

To clean the surface of the door and the surface of the oven that come together upon closing, use only mild, nonabrasive soaps or detergents using a sponge or soft cloth. Rinse with a damp cloth and dry.

Never use a commercial oven cleaner on any part of your microwave oven.

Removable Turntable and Turntable Support Ring

To prevent breakage, do not place the turntable into water just after cooking. Wash it carefully in warm, sudsy water or in the dishwasher. The turntable and support ring can be broken if dropped. Remember, do not operate the oven without the turntable and support ring in place.

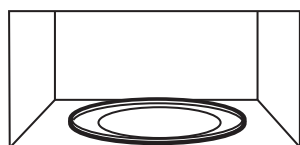
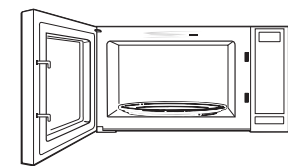



How to Clean the Outside

Do not use cleaners containing ammonia or alcohol on the microwave oven. Ammonia or alcohol can damage the appearance of the microwave oven. If you choose to use a common household cleaner, first apply the cleaner directly to a clean cloth, then wipe the soiled area.

Stainless Steel

Do not use a steel-wool pad; it will scratch the surface.

To clean the stainless steel surface, use a hot, damp cloth with a mild detergent suitable for stainless steel surfaces. Use a clean, hot, damp cloth to remove soap. Dry with a dry, clean cloth.

The stainless steel can be cleaned with Cerama Bryte® or a similar product using a clean, soft cloth. You can order Cerama Bryte® Stainless Steel Appliance Cleaner through GE Parts by calling 800.626.2002.

Control Panel and Door

Wipe with a damp cloth. Dry thoroughly. Do not use cleaning sprays, large amounts of soap and water, abrasives or sharp objects on the panel—they can damage it. Some paper towels can also scratch the control panel.

Door Surface

It is important to keep the area clean where the door seals against the microwave oven. Use only mild, non-abrasive detergents applied with a clean sponge or soft cloth. Rinse well.

Power Cord

If the cord becomes soiled, unplug and wash with a damp cloth. For stubborn spots, sudsy water may be used, but be certain to rinse with a damp cloth and dry thoroughly before plugging cord into outlet.

Before you call for service...

Troubleshooting Tips

Save time and money! Review the chart below and you may not need to call for service.

Problem	Possible Causes	What To Do
Oven will not start	A fuse in your home may be blown or the circuit breaker tripped.	<ul style="list-style-type: none"> • Replace fuse or reset circuit breaker.
	Power surge.	<ul style="list-style-type: none"> • Unplug the microwave oven, then plug it back in.
	Plug not fully inserted into wall outlet.	<ul style="list-style-type: none"> • Make sure the 3-prong plug on the oven is fully inserted into wall outlet.
	Door not securely closed.	<ul style="list-style-type: none"> • Open the door and close securely.
Control panel lighted, yet oven will not start	Door not securely closed.	<ul style="list-style-type: none"> • Open the door and close securely.
	START pad not pressed after entering cooking selection.	<ul style="list-style-type: none"> • Press START.
	Another selection entered already in oven and STOP/RESET pad not pressed to cancel it.	<ul style="list-style-type: none"> • Press STOP/RESET.
	Cooking time not entered after pressing POWER LEVEL.	<ul style="list-style-type: none"> • Make sure you have entered cooking time after pressing POWER LEVEL and before pressing START.
	CLEAR/OFF was pressed accidentally.	<ul style="list-style-type: none"> • Reset cooking program and press START.
	Food weight not entered after selecting INVERTER DEFROST.	<ul style="list-style-type: none"> • Make sure you have entered food weight after selecting INVERTER DEFROST.
	Oven was paused accidentally.	<ul style="list-style-type: none"> • Press START to restart the cooking program.
SENSOR ERROR message appears on display	During the Sensor cooking program, the door was opened or STOP/RESET was pressed before steam could be detected.	<ul style="list-style-type: none"> • Close the door and press START immediately.
	Steam was not detected in maximum amount of time.	<ul style="list-style-type: none"> • Press STOP/RESET.
"LOCK" appears on the display	The control has been locked. (When the control panel is locked, LOCK will be displayed.)	<ul style="list-style-type: none"> • The child lock-out has been initiated. Press the OPTIONS pad, then select 5 (CHILD LOCK-OUT) and press 2 to cancel lock-out.
Food amount too large for Sensor Reheat	Sensor Reheat is for single servings of recommended foods.	<ul style="list-style-type: none"> • Use Time Cooking for large amounts of food.

Things That Are Normal With Your Microwave Oven

- Steam or vapor escaping from around the door.
- Light reflection around door or outer case.
- Dimming oven light and change in the blower sound at power levels other than high.
- Dull thumping sound while oven is operating.
- TV/radio interference might be noticed while using the microwave. Similar to the interference caused by other small appliances, it does not indicate a problem with the microwave. Plug the microwave into a different electrical circuit, move the radio or TV as far away from the microwave as possible or check the position and signal of the TV/radio antenna.

GE Microwave Oven Warranty.

All warranty service provided by our Factory Service Centers, or an authorized Customer Care® technician. To schedule service, on-line, 24 hours a day, visit us at GEAppliances.com, or call 800.GE.CARES (800.432.2737). Please have serial and model numbers available when calling for service.

Staple your receipt here.
Proof of the original purchase date is needed to obtain service under the warranty.

For The Period Of:	GE Will Replace:
One Year <i>From the date of the original purchase</i>	Any part of the microwave oven which fails due to a defect in materials or workmanship. During this limited one-year warranty , GE will also provide, free of charge , all labor and related service to replace the defective part.
Five Years From the date of the original purchase	The magnetron tube , if the magnetron tube fails due to a defect in materials or workmanship. During this five-year limited warranty , you will be responsible for any labor or in-home service costs.

For each of the above limited warranties: To avoid any trip charges, you must take the microwave oven to a General Electric Customer Care® servicer and pick it up following service. In-home service is also available, but you must pay for the service technician's travel costs to your home.

What GE Will Not Cover:

- Service trips to your home to teach you how to use the product.
- Improper installation, delivery or maintenance.
- Product not accessible to provide required service.
- Failure of the product or damage to the product if it is abused, misused (for example, cavity arcing from wire rack or metal/foil), or used for other than the intended purpose or used commercially.
- Replacement of house fuses or resetting of circuit breakers.
- Damage to the product caused by accident, fire, floods or acts of God.
- Incidental or consequential damage caused by possible defects with this appliance.
- Damage caused after delivery.

EXCLUSION OF IMPLIED WARRANTIES—Your sole and exclusive remedy is product repair as provided in this Limited Warranty. Any implied warranties, including the implied warranties of merchantability or fitness for a particular purpose, are limited to one year or the shortest period allowed by law.

This warranty is extended to the original purchaser and any succeeding owner for products purchased for home use within the USA. If the product is located in an area where service by a GE Authorized Servicer is not available, you may be responsible for a trip charge or you may be required to bring the product to an Authorized GE Service Location for service. In Alaska, the warranty excludes the service calls to your home. Some states do not allow the exclusion or limitation of incidental or consequential damages. This warranty gives you specific legal rights, and you may also have other rights which vary from state to state. To know what your legal rights are, consult your local or state consumer affairs office or your state's Attorney General.

Warrantor: General Electric Company. Louisville, KY 40225

Consumer Support.



GE Appliances Website

GEAppliances.com

Have a question or need assistance with your appliance? Try the GE Appliances Website 24 hours a day, any day of the year! For greater convenience and faster service, you can now download Owner's Manuals, order parts, catalogs, or even schedule service on-line. You can also "Ask Our Team of Experts™" your questions, and so much more...



Schedule Service

GEAppliances.com

Expert GE repair service is only one step away from your door. Get on-line and schedule your service at your convenience 24 hours any day of the year! Or call 800.GE.CARES (800.432.2737) during normal business hours.



Real Life Design Studio

GEAppliances.com

GE supports the Universal Design concept—products, services and environments that can be used by people of all ages, sizes and capabilities. We recognize the need to design for a wide range of physical and mental abilities and impairments. For details of GE's Universal Design applications, including kitchen design ideas for people with disabilities, check out our Website today. For the hearing impaired, please call 800.TDD.GEAC (800.833.4322).



Extended Warranties

GEAppliances.com

Purchase a GE extended warranty and learn about special discounts that are available while your warranty is still in effect. You can purchase it on-line anytime, or call 800.626.2224 during normal business hours. GE Consumer Home Services will still be there after your warranty expires.

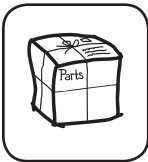

Parts and Accessories

GEAppliances.com

Individuals qualified to service their own appliances can have parts or accessories sent directly to their homes (VISA, MasterCard, and Discover cards are accepted). Order on-line today, 24 hours every day or by phone at 800.626.2002 during normal business hours.

Instructions contained in this manual cover procedures to be performed by any user. Other servicing generally should be referred to qualified service personnel. Caution must be exercised, since improper servicing may cause unsafe operation.

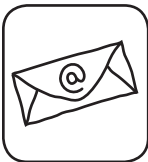

Contact Us

GEAppliances.com

If you are not satisfied with the service you receive from GE, contact us on our Website with all the details including your phone number, or write to: General Manager, Customer Relations
GE Appliances, Appliance Park
Louisville, KY 40225



Register Your Appliance

GEAppliances.com

Register your new appliance on-line—at your convenience! Timely product registration will allow for enhanced communication and prompt service under the terms of your warranty, should the need arise. You may also mail in the pre-printed registration card included in the packing material.