



# MICROWAVE OVEN

**SAFETY INFORMATION** .....3

**USING YOUR OVEN**

Oven Features.....6

Controls.....7

Power Levels.....8

Features.....8

Defrost.....11

Microwave Terms.....12

**CARE AND CLEANING**

Care and Cleaning.....13

**TROUBLESHOOTING**

Things that are Normal.....14

**CONSUMER SUPPORT**

Warranty.....15

Consumer Support.....Back Cover

## OWNER'S MANUAL

JES1145  
JESP113

Write the model and serial numbers here:

Model # \_\_\_\_\_

Serial # \_\_\_\_\_

You can find them on a label inside the oven.

### ESPAÑOL

Para consultar una version en español de este manual de instrucciones, visite nuestro sitio de internet [GEAppliances.com](http://GEAppliances.com).

## **THANK YOU FOR MAKING GE APPLIANCES A PART OF YOUR HOME.**

---

Whether you grew up with GE Appliances, or this is your first, we're happy to have you in the family.

We take pride in the craftsmanship, innovation and design that goes into every GE Appliances product, and we think you will too. Among other things, registration of your appliance ensures that we can deliver important product information and warranty details when you need them.

Register your GE appliance now online. Helpful websites and phone numbers are available in the Consumer Support section of this Owner's Manual. You may also mail in the pre-printed registration card included in the packing material.



**GE APPLIANCES**

# IMPORTANT SAFETY INSTRUCTIONS

## READ ALL INSTRUCTIONS BEFORE USING THE APPLIANCE

### **⚠ WARNING**

To reduce the risk of burns, electric shock, fire, injury to persons, or exposure to excessive microwave energy:

When using electrical appliances, basic safety precautions should be followed, including the following:

- Read all instructions before using this appliance.
- Read and follow the specific precautions in the PRECAUTIONS TO AVOID POSSIBLE EXPOSURE TO EXCESSIVE MICROWAVE ENERGY section on page 5.
- Use this appliance only for its intended use as described in this manual. Do not use corrosive chemicals or vapors in this appliance. This microwave oven is specifically designed to heat, dry or cook food, and is not intended for laboratory or industrial use.
- This appliance should be serviced only by qualified service personnel. Contact nearest authorized service facility for examination, repair, or adjustment.

#### **INSTALLATION**

- Install or locate this appliance only in accordance with the provided installation instructions.
- This appliance must be grounded. Connect only to a properly grounded outlet. See the GROUNDING INSTRUCTIONS section on page 5.
- Be certain to place the front surface of the door 3 inches or more back from the counter top edge to avoid accidental tipping of the appliance in normal usage.
- Recommended clearances: 3 inches on each side, 3 inches on the top, and 1 inch in the rear.
- Do not operate this appliance if it has a damaged power cord or plug, if it is not working properly, or if it has been damaged or dropped.
- Keep power cord away from heated surfaces.
- Do not let cord hang over edge of table or counter.
- Do not immerse power cord or plug in water.
- Do not cover or block any opening on the appliance.
- Do not store this appliance outdoors. Do not use this product near water - for example, in a wet basement, near a swimming pool, or in a similar location.
- Do not mount over a sink.

#### **TO REDUCE THE RISK OF FIRE IN THE CAVITY:**

- Do not overcook food. Carefully attend appliance when paper, plastic or other combustible materials are placed inside the oven while cooking.
- Remove wire twist-ties and metal handles from paper or plastic containers before placing them in the oven.
- If materials inside the oven ignite, keep the oven door closed, turn the oven off and disconnect the power cord, or shut off power at the fuse or circuit breaker panel.
- Do not store any materials in the oven when not in use. Do not leave paper products, cooking utensils, or food in the cavity when not in use. All racks should be removed from oven when not in use.
- Do not operate the microwave feature without food in the oven.

#### **TO REDUCE THE RISK OF BURNS**

- Be careful when opening containers of hot food. Use pot holders and direct steam away from face and hands.
- Vent, pierce, or slit containers, pouches or plastic bags to prevent build-up of pressure.
- Be careful when touching the turntable, door, rack or walls of the oven which may become hot during use.
- Liquids and certain foods heated in the microwave oven can present a risk of burn when removing them from the microwave. The potential for a burn is greater in young children, who should not be allowed to remove hot items from the microwave.

## READ AND SAVE THESE INSTRUCTIONS

# IMPORTANT SAFETY INSTRUCTIONS

## READ ALL INSTRUCTIONS BEFORE USING THE APPLIANCE

### **⚠ WARNING**

#### **OPERATING**

- As with any appliance, close supervision is necessary when used by children.
- Do not operate the oven without the turntable in place. The turntable must be unrestricted so it can turn.
- Make sure all cookware used in your microwave oven is suitable for microwaving. Most glass casseroles, cooking dishes, measuring cups, custard cups, pottery or china dinnerware which does not have metallic trim or glaze with a metallic sheen can be used in compliance with cookware manufacturers' recommendations.
- Do not store anything directly on top of the microwave surface when the microwave is in operation.
- Some products such as whole eggs and sealed containers - for example, closed jars - are able to explode and should not be heated in the microwave oven.
- Do not overcook potatoes. They could dehydrate and catch fire.
- Do not cover any other part of the oven with metal foil. This will cause overheating of the oven.
- Cook meat and poultry thoroughly—meat to at least an INTERNAL temperature of 160°F and poultry to at least an INTERNAL temperature of 180°F. Cooking to these temperatures usually protects against foodborne illness.
- This oven is not approved or tested for marine use.

#### **CLEANING**

- Keep the oven free from grease buildup.
- Do not clean with metal scouring pads. Pieces can burn off the pad and touch electrical parts involving risk of electric shock.
- When cleaning surfaces of door and oven that comes together on closing the door, use only mild, nonabrasive soaps, or detergents applied with a clean sponge or soft cloth. Rinse well.

#### **SUPER HEATED WATER**

- Liquids, such as water, coffee, or tea, are able to be overheated beyond the boiling point without appearing to be boiling. Visible bubbling or boiling when the container is removed from the microwave oven is not always present. **THIS COULD RESULT IN VERY HOT LIQUIDS SUDDENLY BOILING OVER WHEN THE CONTAINER IS DISTURBED OR A SPOON OR OTHER UTENSIL IS INSERTED INTO THE LIQUID.**
- To reduce the risk of injury to persons:
  - Do not overheat the liquid.
  - Stir the liquid both before and halfway through heating it.
  - Do not use straight-sided containers with narrow necks.
  - After heating, allow the container to stand in the microwave oven for a short time before removing the container.
  - Use extreme care when inserting a spoon or other utensil into the container.

**READ AND SAVE THESE INSTRUCTIONS**

# IMPORTANT SAFETY INSTRUCTIONS

## READ ALL INSTRUCTIONS BEFORE USING THE APPLIANCE

### PRECAUTIONS TO AVOID POSSIBLE EXPOSURE TO EXCESSIVE MICROWAVE ENERGY

- (a) **Do Not Attempt** to operate this oven with the door open since open-door operation can result in harmful exposure to microwave energy. It is important not to defeat or tamper with the safety interlocks.
- (b) **Do Not Place** any object between the oven front face and the door or allow soil or cleaner residue to accumulate on sealing surfaces.
- (c) **Do Not Operate** the oven if it is damaged. It is particularly important that the oven door close properly and that there is no damage to the:
  - (1) door (bent),
  - (2) hinges and latches (broken or loosened),
  - (3) door seals and sealing surfaces.
- (d) **The Oven Should Not** be adjusted or repaired by anyone except properly qualified service personnel.

### GROUNDING INSTRUCTIONS

#### ⚠ WARNING

Improper use of the grounding plug can result in a risk of electric shock.

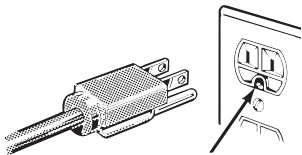

Ensure proper ground exists before use.

This appliance must be grounded. In the event of an electrical short circuit, grounding reduces the risk of electric shock by providing an escape wire for the electric current.

This appliance is equipped with a power cord having a grounding wire with a grounding plug. The plug must be plugged into an outlet that is properly installed and grounded.

Consult a qualified electrician or service technician if the **GROUNDING INSTRUCTIONS** are not completely understood, or if doubt exists as to whether the appliance is properly grounded.

If the outlet is a standard 2-prong wall outlet, it is your personal responsibility and obligation to have it replaced with a properly grounded 3-prong wall outlet.

Do not under any circumstances cut or remove the third (ground) prong from the power cord.

Do not use an extension cord. If the power cord is too short, have a qualified electrician or service technician install an outlet near the appliance.

For best operation, plug this appliance into its own electrical outlet to prevent flickering of lights, blowing of fuse or tripping of circuit breaker.

#### NOTICE: PACEMAKERS

Most pacemakers are shielded from interference from electronic products, including microwaves. However, patients with pacemakers may wish to consult their physicians if they have concerns.

## READ AND SAVE THESE INSTRUCTIONS

# Features

Throughout this manual, features and appearance may vary from your model.

950 Watts

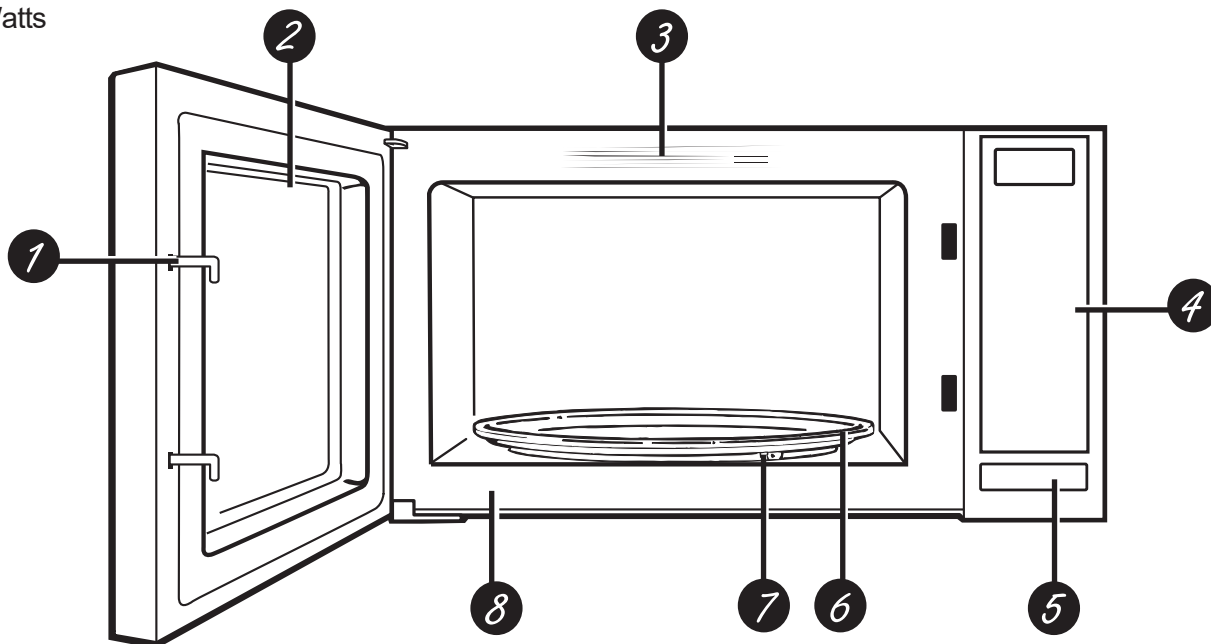

**1 Door Latches**

**2 Window with Metal Shield.** Screen allows cooking to be viewed while keeping microwaves confined in the oven.

**3 Convenience Guide**

**4 Touch Control Panel Display**

**5 Door Latch Release.** Press latch release to open door.

**6 Removable Turntable.** Turntable and support must be in place when using the oven. The turntable may be removed for cleaning.

**7 Removable Turntable.** The turntable support must be in place when using the oven.

**8 Rating Label.** Rating plate is located on the front of the microwave oven.

# Controls

You can microwave by time or with the convenience features.



Control buttons' functions are explained on the following pages.

# Changing the power level

**Changing the Power Level:** the power level can be changed only when using **Time Cook** or **Time Defrost** buttons and is explained in the sections for the functions of these buttons.

Variable power levels add flexibility to microwave cooking. The power levels on the microwave oven can be compared to the surface units on a range. Each power level gives you microwave energy a certain percent of the time. **Power level 7** is microwave energy 70% of the time. **Power level 3** is energy 30% of the time. Most cooking will be done on **power level 10** which gives you 100% power. **Power level 10** will cook faster but food may need more frequent stirring, rotating or turning over. A lower setting will cook more evenly and need less stirring or rotating of the food. Some foods may have better flavor, texture or appearance if one of the lower settings is used. Use a lower power level when cooking foods that have a tendency to boil over, such as scalloped potatoes.

Rest periods (when the microwave energy cycles off) give time for the food to “equalize” or transfer heat to the inside of the food. An example of this is shown with **power level 3**—the defrost cycle. If microwave energy did not cycle off, the outside of the food would cook before the inside was defrosted.

Here are some examples of uses for various power levels:

- High 10:** Fish, bacon, vegetables, heating liquids.
- Med-High 7:** Gentle cooking of meat and poultry; baking casseroles and reheating.
- Medium 5:** Slow cooking and tenderizing for stews and less tender cuts of meat.
- Low 2 or 3:** Defrosting; simmering; delicate sauces.
- Warm 1:** Keeping food warm; softening butter.

## Pause/Off

Use the **Pause/Off** button when you need to start over when you are setting a button feature, or when you need to clear the display

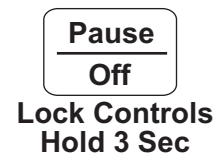

## Time Cook

Allows you to microwave from 1 second to 99 minutes and 99 seconds.

1. Press **Time Cook**.
2. Enter cooking time.
3. Power level is automatically set to 10, but if you want to reduce it, press **Power**, then select a level from 0 to 9.
4. Press **Start/+30 Sec**.



You may open the door during **Time Cook** to check the food. Close the door and press **Start/+30 Sec** to resume cooking.

## Express Cook

This is a quick way to set cooking time from 1-6 minutes.

1. Press one of the **Express Cook** pads (from 1-6) for 1-6 minutes of cooking at **power level 10**. For example, press the 2 pad for 2 minutes of cooking time.

The power level can be changed as time is counting down. Press **POWER LEVEL** and enter 1-10.

**NOTE:** Express Cook function pertains to pads 1-6 only.

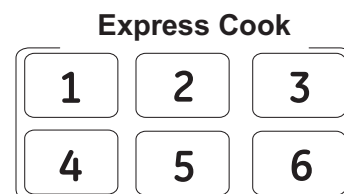



# About the features

---

## + 30 Sec

It will add 30 seconds to the time counting down each time the pad is pressed. Each touch will add 30 seconds, up to 99 minutes and 99 seconds.

The oven will start immediately when pressed.

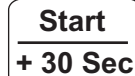
A rectangular button with rounded corners. The text "Start" is positioned above a horizontal line, and "+ 30 Sec" is positioned below the line.

---

## Popcorn

To use the **Popcorn** feature:

1. Follow package instructions, using **Time Cook** if the package is less than 1.75 ounces or larger than 3.5 ounces. Place the package of popcorn in the center of the microwave.

2. Press **Popcorn** once for a 1.75 ounce package of popcorn.

Press **Popcorn** again for a 3.0 ounce package. Press **Popcorn** a third time for a 3.5 ounce package.

3. Press **Start/+30 Sec**

Your popcorn bag may get stuck and stop rotating, but this will not effect the cooking performance. Do not open the door even if the bag is not rotating.

**NOTE:** Use only with prepackaged microwave popcorn weighing 1.75, 3.0 to 3.5 ounces.

A rectangular button with rounded corners containing the text "Popcorn".

---

## Potato

To use the **Potato** feature:

1. Press the **Potato** pad repeatedly until the number of potatoes appear in the display (1, 2, 3 or 4 potatoes).

2. Press **Start/+30 Sec**.

A rectangular button with rounded corners containing the text "Potato".

---

## Frozen Vegetable

To use the **Frozen Vegetable** feature:

1. Press the **Frozen Vegetable** pad repeatedly until the number of ounces appear in the display (4, 8, or 16 oz).

2. Press **Start/+30 Sec**.

A rectangular button with rounded corners containing the text "Frozen Vegetable".

---

## Beverage

To use the **Beverage** feature:

1. Press the **Beverage** pad repeatedly until the number of cups appear in the display (1, 2, or 3 cups).

2. Press **Start/+30 Sec**

A rectangular button with rounded corners containing the text "Beverage".

# About the features

---

## Pizza

To use the **Pizza** feature:

1. Press the **Pizza** pad repeatedly until the number of ounces appear in the display (1, 2, or 3 pieces).
2. Press **Start/+30 Sec.**



---

## Dinner Plate

To use the **Dinner Plate** feature:

1. Press the **Dinner Plate** pad repeatedly until the number of ounces appear in the display (9, 12, or 18 oz).
2. Press **Start/+30 Sec.**



---

## Clock

Press to enter the time of day.

1. Press **Clock**.
2. Enter time of day.
3. Press **Clock**.



---

## Kitchen Timer

Press to use the kitchen timer. The Kitchen Timer can be used while the microwave is operating.

1. Press **Kitchen Timer**.
2. Enter the amount of time.
3. Press **Kitchen Timer**.



NOTE: The kitchen timer continues to beep when the time has expired. To clear the timer press **Kitchen Timer**.

---

## Inquiring Function

While the microwave is operating, you can press **Power** to view the power level being used, or **Clock** to view the current time. After 3 seconds the display will return to the countdown time.





---

## Control Lock-Out

You may lock the control panel to prevent the microwave from being accidentally started or used by children.

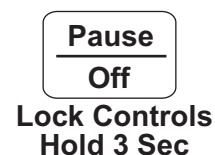
To lock or unlock the controls, press and hold **Pause/Off** for about three seconds. When the control panel is locked, the lock indicator will be lit.



# Defrosting

## Time Defrost

Allows you to defrost for a selected length of time. See the Defrosting Guide for suggested times.

**Time  
Defrost**

1. Press **Time Defrost**.
2. Enter defrost time.
3. Power level is automatically set to 3, but if you want to change it, press **Power**, then select a level from 0 to 9.
4. Press **Start/+30 Sec**.
5. Turn the food over after half the time.
6. Press **Start/+30 Sec**.

At one half of selected defrosting time, turn food over and break apart or rearrange pieces for more even defrosting. Shield any warm areas with small pieces of foil. The oven will continue to defrost if you don't open the door and turn the food.

A dull thumping noise may be heard during defrosting. This is normal when oven is not operating at Power level 10.

### Defrosting Tips

- Foods frozen in paper or plastic can be defrosted in the package. Closed packages should be slit, pierced or vented **AFTER** food has partially defrosted. Plastic storage containers should be partially uncovered.
- Family-size, prepackaged frozen dinners can be defrosted and microwaved. If the food is in a foil container, transfer it to a microwave-safe dish.
- Foods that spoil easily should not be allowed to sit out for more than one hour after defrosting. Room temperature promotes the growth of harmful bacteria.
- For more even defrosting of larger foods, such as roasts, use **Weight Defrost**. Be sure large meats are completely defrosted before cooking.
- When defrosted, food should be cool but softened in all areas. If still slightly icy, return to the microwave very briefly, or let it stand a few minutes.

## Defrosting Guide

Food	Time	Comments
<b>Breads, Cakes</b> <i>Bread, buns, or rolls</i> (1 piece) <i>Sweet rolls</i> (approx. 12 oz.)	<b>1/4 min.</b> <b>2 to 4 min.</b>	Rearrange after half the time.
<b>Fish and Seafood</b> <i>Filletts, frozen</i> (1 lb.) <i>Shellfish, small pieces</i> (1 lb.)	<b>6 to 9 min.</b> <b>3 to 7 min.</b>	Place block in casserole. Turn over and break up after half the time.
<b>Fruit</b> <i>Plastic pouch—1 or 2</i> (10-oz. package)	<b>1 to 5 min.</b>	
<b>Meat</b> <i>Bacon</i> (1 lb.) <i>Franks</i> (1 lb.) <i>Ground meat</i> (1 lb.) <i>Roast: beef, lamb, veal, pork</i> <i>Steaks, chops and cutlets</i>	<b>2 to 5 min.</b> <b>2 to 5 min.</b> <b>4 to 6 min.</b> <b>9 to 13 min.</b> <b>per lb.</b> <b>4 to 8 min.</b> <b>per lb.</b>	Place unopened package in oven. Let stand 5 minutes after defrosting. Place unopened package in oven. Microwave just until franks can be separated. Let stand 5 minutes, if necessary, to complete defrosting. Turn meat over after first half of time. Use power level 10. Place unwrapped meat in cooking dish. Turn over after first half of time and shield warm areas with foil. After second half of time, separate pieces with table knife. Let stand to complete defrosting.
<b>Poultry</b> <i>Chicken, broiler-fryer, cut up</i> (2½ to 3 lbs.) <i>Chicken, whole</i> (2½ to 3 lbs.) <i>Cornish hen</i> <i>Turkey breast</i> (4 to 6 lbs.)	<b>14 to 20 min.</b> <b>20 to 25 min.</b> <b>7 to 13 min.</b> <b>per lb.</b> <b>3 to 8 min.</b> <b>per lb.</b>	Place wrapped chicken in dish. Unwrap and turn over after first half of time. After second half of time, separate pieces and place in cooking dish. Microwave 2 to 4 minutes more, if necessary. Let stand a few minutes to finish defrosting. Place wrapped chicken in dish. After half the time, unwrap and turn chicken over. Shield warm areas with foil. To complete defrosting, run cold water in the cavity until giblets can be removed. Place unwrapped hen in the oven breast-side-up. Turn over after first half of time. Run cool water in the cavity until giblets can be removed. Place unwrapped breast in microwave-safe dish breast-side-down. After first half of time, turn breast-side-up and shield warm areas with foil. Defrost for second half of time. Let stand 1 to 2 hours in refrigerator to complete defrosting.

## Weight Defrost

Allows you to defrost food by its weight.

1. Press **Weight Defrost**.
2. Enter weight from 4 to 99 ounces.
3. Press **Start/+30 Sec**.

(The Power level is not adjustable when using Weight Defrost.)

**Weight  
Defrost**

# About the features

## Multi-Stage Cooking

At most 2 stages can be set for cooking. In multi-stage cooking, if one stage is defrosting, then defrosting shall be placed at the first stage automatically.

Note: Auto cooking cannot work in the multi-stage cooking.

Example: if you want to cook with 80% microwave power for 5 minutes + 60% microwave power for 10 minutes. The cooking steps are as following:



1. Press **Time Cook** once, then press “5”, “0”, “0” to set the cooking time;
2. Press **Power** once, then press “8” to select 80% microwave power.
3. Press **Time Cook** once, then press “1”, “0”, “0”, “0” to set the cooking time;
4. Press **Power** once, then press “6” to select 60% microwave power.
5. Press **Start/+30 Sec.**

## Microwave Terms

Term	Definition
Arcing	Arcing is the microwave term for sparks in the oven. Arcing is caused by: <ul style="list-style-type: none"> <li>■ metal or foil touching the side of the oven.</li> <li>■ foil that is not molded to food (upturned edges act like antennas).</li> <li>■ metal such as twist-ties, poultry pins, gold-rimmed dishes.</li> <li>■ recycled paper towels containing small metal pieces.</li> <li>■ plates or dishes with a metallic trim or glaze with a metallic sheen.</li> </ul>
Covering	Covers hold in moisture, allow for more even heating and reduce cooking time. Venting plastic wrap or covering with wax paper allows excess steam to escape.
Shielding	In a regular oven, you shield chicken breasts or baked foods to prevent over-browning. When microwaving, you use small strips of foil to shield thin parts, such as the tips of wings and legs on poultry, which would cook before larger parts.
Standing Time	When you cook with regular ovens, foods such as roasts or cakes are allowed to stand to finish cooking or to set. Standing time is especially important in microwave cooking. Note that a microwaved cake is not placed on a cooling rack.
Venting	After covering a dish with plastic wrap, you vent the plastic wrap by turning back one corner so excess steam can escape.

# Care and Cleaning

## Helpful Hints

An occasional thorough wiping with a solution of baking soda and water keeps the inside fresh.

**Be certain the oven control is turned off before cleaning any part of this oven.**

## How to Clean the Inside

### Walls, Floor, Inside Window, Metal and Plastic Parts on the Door

Some spatters can be removed with a paper towel; others may require a damp cloth. Remove greasy spatters with a sudsy cloth, then rinse with a damp cloth. Do not use abrasive cleaners or sharp utensils on oven walls.

To clean the surface of the door and the surface of the oven that come together upon closing, use only mild, nonabrasive soaps or detergents using a sponge or soft cloth. Rinse with a damp cloth and dry.

Never use a commercial oven cleaner on any part of your microwave.

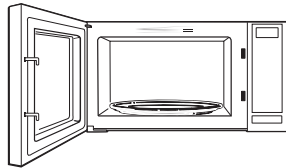

### Removable Turntable and Turntable Support

To prevent breakage, do not place the turntable into water just after cooking. Wash it carefully in warm, sudsy water or in the dishwasher. The turntable and support can be broken if dropped. Remember, do not operate the oven in the microwave mode without the turntable and support seated and in place.



## How to Clean the Outside

Do not use cleaners containing ammonia or alcohol on the microwave oven. Ammonia or alcohol can damage the appearance of the microwave.

### Case

Clean the outside of the microwave with a sudsy cloth. Rinse with a damp cloth and then dry. Wipe the window clean with a damp cloth.

### Control Panel and Door

Wipe with a damp cloth. Dry thoroughly. Do not use cleaning sprays, large amounts of soap and water, abrasives or sharp objects on the panel—they can damage it. Some paper towels can also scratch the control panel.

### Door Surface

It is important to keep the area clean where the door seals against the microwave. Use only mild, non-abrasive detergents applied with a clean sponge or soft cloth. Rinse well.

### Power Cord

If the cord becomes soiled, unplug and wash with a damp cloth. For stubborn spots, sudsy water may be used, but be certain to rinse with a damp cloth and dry thoroughly before plugging cord into outlet.

### Stainless Steel (on some models)

Do not use a steel-wood pad; it will scratch the surface.

To clean the stainless steel surface, use a hot, damp cloth with a mild detergent suitable for stainless steel surfaces. Use a clean, hot, damp cloth to remove soap. Dry with a dry, clean cloth. Always scrub lightly in the direction of the grain.

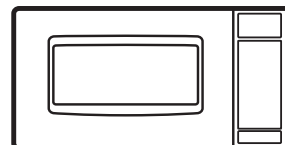

## Troubleshooting Tips

Problem	Possible Cause
Oven will not come on	A fuse in your home may be blown or the circuit breaker tripped. Replace fuse or reset circuit breaker.
	Unplug your microwave oven, then plug it back in.
	Make sure 3-prong plug on oven is fully inserted into wall receptacle.
Control panel lighted, yet oven will not start	Door not securely closed.
	<b>Start/+30 Sec</b> must be pressed after entering cooking selection.
	Another selection entered already in oven and <b>Pause/Off</b> not pressed to cancel it.
	Make sure you have entered cooking time after pressing <b>Cook Time</b> .
	<b>Pause/Off</b> was pressed accidentally. Reset cooking program and press <b>Start/+30 Sec</b> .
	Make sure you entered food weight after pressing <b>Defrost Weight</b> .
Oven was paused accidentally. Press <b>Start/+30 Sec</b> to restart the cooking program.	
"FOOD" appears on display	The control detected that the door has not been opened (food/beverage has not been placed inside).
"LOC" appears on display	The control panel has been locked. (When the control panel is locked, "LOC" will be displayed.) Press and hold <b>Pause/Off</b> for about 3 seconds to unlock the control panel.
"PF" appears on display	A Power Failure has occurred. Press <b>Pause/Off</b> to clear the display.

### Things That Are Normal With Your Microwave Oven

- Steam or vapor escaping from around the door.
- Light reflection around door or outer case.
- Dimming oven light and change in the blower sound at power levels other than high.
- Dull thumping sound while oven is operating.
- TV/radio interference might be noticed while using the microwave. Similar to the interference caused by other small appliances, it does not indicate a problem with the microwave. Plug the microwave into a different electrical circuit, move the radio or TV as far away from the microwave as possible, or check the position and signal of the TV/radio antenna.

# GE Appliances Microwave Oven Limited Warranty

WARRANTY

Staple your receipt here.  
Proof of the original purchase  
date is needed to make a  
warranty claim.

For the period of	GE Appliances Will Choose to Repair or Replace:
<b>One year</b> From the date of the original purchase	Any product which fails due to a defect in materials or workmanship. The exchange unit is warranted for the remainder of your product's original one-year warranty period.

### In Order to Make a Warranty Claim:

Call GE Appliances at 800 GE CARES (800 432-2737). Have the model number and serial number available.

### What GE Appliances Will Not Cover:

- Customer instructions. This owner's manual provides information regarding operating instructions and user controls. The Owner's Manual is available online at [GEAPPLIANCES.com](http://GEAPPLIANCES.com)
- Improper installation, delivery or maintenance.
- Failure of the product or damage to the product if it is abused, misused (for example, cavity arcing from wire rack or metal/foil), or used for other than the intended purpose or used commercially.
- Replacement of house fuses or resetting of circuit breakers.
- Damage to the product caused by accident, fire, floods or acts of God.
- Incidental or consequential damage caused by possible defects with this appliance.
- Damage caused after delivery.

### EXCLUSION OF IMPLIED WARRANTIES

Your sole and exclusive remedy is product repair as provided in this Limited Warranty. Any implied warranties, including the implied warranties of merchantability or fitness for a particular purpose, are limited to one year or the shortest period allowed by law.

This limited warranty is extended to the original purchaser and any succeeding owner for products purchased for home use within the USA.

Some states do not allow the exclusion or limitation of incidental or consequential damages. This limited warranty gives you specific legal rights, and you may also have other rights which vary from state to state. To know what your legal rights are, consult your local or state consumer affairs office or your state's Attorney General.

Exclusion of implied warranties: Except where prohibited or restricted by law, there are no warranties, whether express, oral or statutory which extend beyond the description on the face hereof, including specifically the implied warranties of merchantability or fitness for a particular purpose.

**Warrantor: GE Appliances, a Haier company**  
**Louisville, KY 40225**

# Consumer Support

---

## GE Appliances Website

Have a question or need assistance with your appliance? Try the GE Appliances Website 24 hours a day, any day of the year! You can also shop for more great GE Appliances products and take advantage of all our on-line support services designed for your convenience. In the US: [GEAppliances.com](http://GEAppliances.com)

---

## Register Your Appliance

Register your new appliance on-line at your convenience! Timely product registration will allow for enhanced communication and prompt service under the terms of your warranty, should the need arise. You may also mail in the pre-printed registration card included in the packing material. In the US: [GEAppliances.com/register](http://GEAppliances.com/register)

---

## Parts and Accessories

Individuals qualified to service their own appliances can have parts or accessories sent directly to their homes (VISA, MasterCard and Discover cards are accepted). Order on-line today 24 hours every day.

In the US: [GEApplianceparts.com](http://GEApplianceparts.com) or by phone at 877.959.8688 during normal business hours.

**Instructions contained in this manual cover procedures to be performed by any user. Other servicing generally should be referred to qualified service personnel. Caution must be exercised, since improper servicing may cause unsafe operation.**

---

## Contact Us

If you are not satisfied with the service you receive from GE Appliances, contact us on our Website with all the details including your phone number, or write to:

In the US: General Manager, Customer Relations | GE Appliances, Appliance Park | Louisville, KY 40225  
[GEAppliances.com/ge/service-and-support/contact.htm](http://GEAppliances.com/ge/service-and-support/contact.htm)