

ID-24FI



## FEATURES

Accepts custom panels for an integrated look within cabinetry or stainless-steel accessory panels and handles to match other Sub-Zero, Wolf, and Cove products\*

Controls temperature within one degree of setpoint

Locks in cold air to ensure freshness with magnetic door seals

Control brightness with soft-on LED lighting

Yields ice automatically and "max ice" for additional production

Open and close doors silently with soft-close technology

Produces ice automatically into a removable ice container

## ACCESSORIES

Dual Installation Kit

Reduced Toekick Divider

Stainless Steel Pro Handles

Stainless Steel Tubular Handles

Stainless Steel Drawer Panels With Pro Handles - 4" Toe Kick

Stainless Steel Drawer Panels With Tubular Handles - 4" Toe Kick

Stainless Steel Dual Installation Kickplates

Accessories are available through an authorized dealer.  
For local dealer information, visit [subzero-wolf.com/locator](https://subzero-wolf.com/locator).

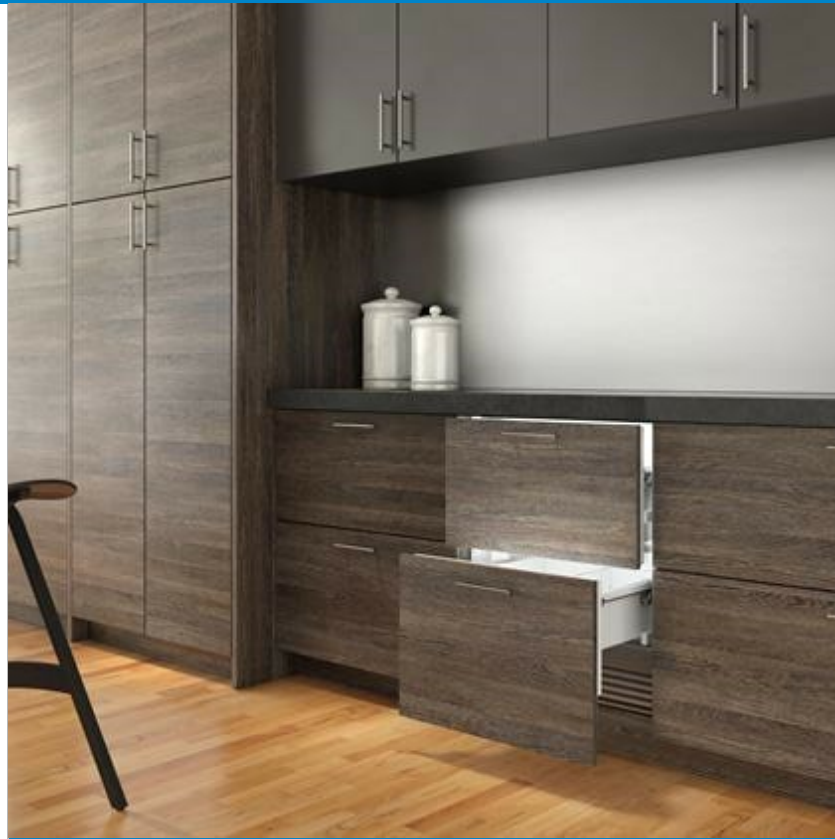

## HANDLE ACCESSORIES

PRO



TUBULAR



## PRODUCT DETAILS

### FREEZER

- Adjustable drawer dividers
- LED lighting

**PRODUCT SPECIFICATIONS**

Model	ID-24FI
Dimensions	24"W x 34 1/2"H x 24"D
Freezer Capacity	3.8 cu. ft.
Weight	185 lbs
Electrical Supply	115 VAC, 60 Hz
Electrical Service	15 amp dedicated circuit
Plumbing Supply	1/4" OD copper, braided stainless steel or PEX tubing
Plumbing Pressure	35-120 psi

**ELECTRICAL**

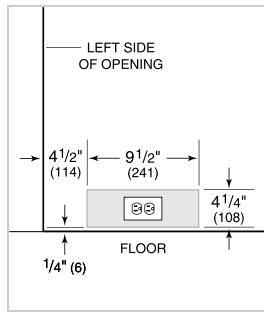

**PLUMBING**

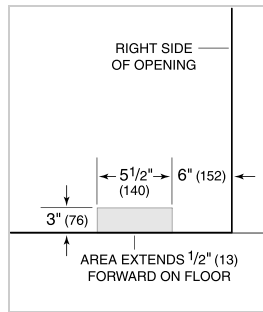

**NOTE:** The electrical outlet must be positioned with the grounding prong to the right of the thinner blades.

**PANEL SPECIFICATIONS** For complete panels specifications including width/height, weight requirements and thickness requirements visit [subzero-wolf.com/reveal](http://subzero-wolf.com/reveal).

**NOTE:** Dimensions in parenthesis are in millimeters unless otherwise specified

**INTERIOR VIEW**

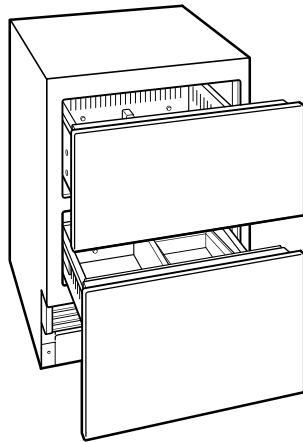

This illustration is intended for interior reference only and may not represent the exterior of the model being specified.

**DIMENSIONS**

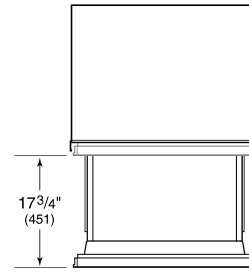
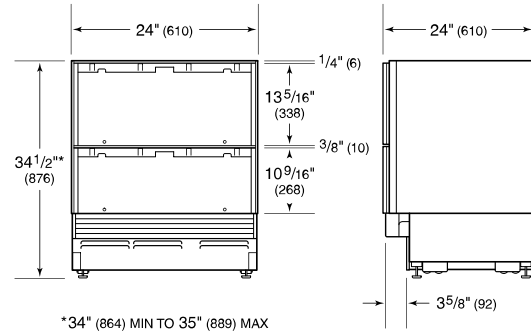

**STANDARD INSTALLATION**

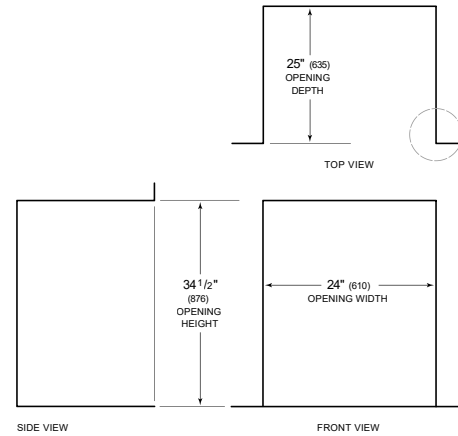

**NOTE:** 3 1/2" (89) finished returns will be visible and should be finished to match cabinetry

