



15" CUBELET ICE MAKERS
Indoor/Outdoor



JOB	
AREA	
ITEM NO.	
MODEL NO.	



H80CIMS-R
Stainless Steel Door Model
Hinged right



H80CIMS-ADL
Stainless Steel Door Model
Hinged left

SIGNATURE SERIES MODELS

MODELS	DESCRIPTION
H80CIMS-L	Solid stainless steel door, hinged left
H80CIMS-R	Solid stainless steel door, hinged right
H80CIMW*	Panel ready door, hinged left or right

ADA-HEIGHT COMPLIANT MODELS

MODELS	DESCRIPTION
H80CIMS-ADL	Solid stainless steel door, hinged left
H80CIMS-ADR	Solid stainless steel door, hinged right
H80CIMW-AD*	Panel ready door, hinged left or right

* This unit comes ready to accept customer-provided overlay panel and handle

KEY PRODUCT FEATURES AND BENEFITS

- Produces soft, chewable, nugget-shaped ice that absorbs the flavors of beverages and is fun to crunch
- Produces up to 80 lbs. of ice per day with a storage capacity of 22 lbs. ensures you always have fresh ice for gatherings of any size
- All stainless steel ice making surface allows easy cleaning and ensures fresh ice for the life of the machine
- ADA-height compliant models available for accessible and aging in place designs

Quick Features:

- Available with stainless steel or panel ready doors to match your design style – panel ready doors accept customer-supplied door overlay and handle
- UL-Approved for outdoor use
- Easily accessible power switch, quickly turn off machine prior to end of season
- Two drain options: Gravity drain or optional drain pump (63802A) ordered separately

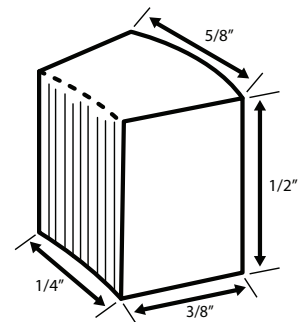

Cubelet Dimensions



15" CUBELET ICE MAKERS
Indoor/Outdoor

MODEL NUMBERS		H80CIMS (Signature Series)	H80CIMS-AD (ADA-Height Compliant Series)
OVERALL DIMENSIONS	Width - in. (mm)	14-7/8" (378mm)	14-7/8" (378mm)
	Depth - in. (mm)	22-9/16" (573 mm)	22-9/16" (573 mm)
	Height - in. (mm)	33-1/2" (851 mm)	31-1/2" (800 mm)
OPENING DIMENSIONS	Width - in. (mm)	15" (381 mm)	15" (381 mm)
	Depth - in. (mm)	24-7/8" (632 mm)	24-7/8" (632 mm)
	Height - in. (mm)	34-1/2"	32-1/4" (819 mm)
SHIPPING WEIGHT Lbs.		560 lbs	560 lbs
ELECTRICAL SPECIFICATIONS	Electrical Supply	115V/60 Hz/1 Ph	115V/60 Hz/1 Ph
	Running Load Amps	3.4 amps	3.4 amps
	Electrical Connection	Cord connected	15 amp dedicated circuit
	Cord Plug Type	NEMA 3 Prong 5-15P	NEMA 5-15 plug, 5'/3 prong grounding-type
	Cord length	6.5 ft	6.5 ft
REFRIGERATION SPECIFICATIONS	Refrigerant	R134a (3.92 oz.)	R134a (3.92 oz.)
	Plumbing	1/2" FTP water Inlet, 1/2" FTP Drain	1/2" FTP water Inlet, 1/2" FTP Drain
OPERATING LIMITS	Ambient Temp Range	45-100F	45-100F
	Water Temp Range	45-90F	45-90F
	Water Pressure	7-113 psig	7-113 psig
	Voltage Range	104-127V	104-127V



15" CUBELET ICE MAKERS
Indoor/Outdoor

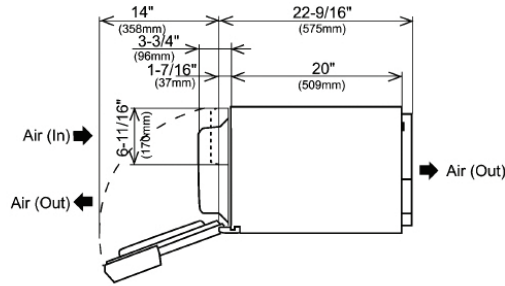

**Top View –
Signature and ADA-Height Compliant Series
Cubelet Ice Makers**

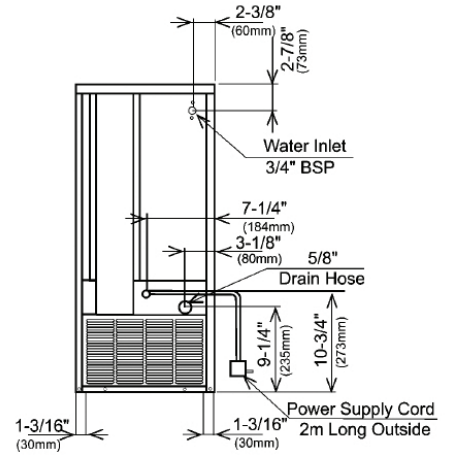
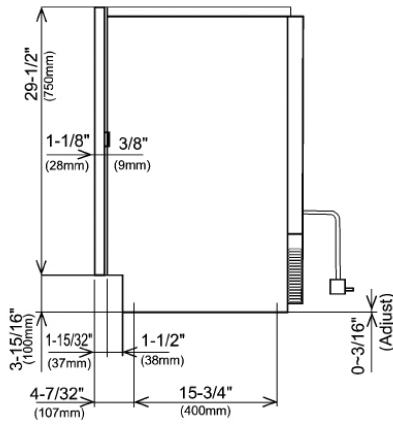
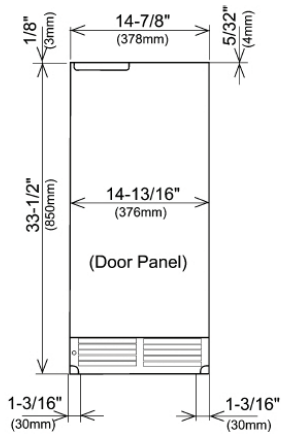

Signature Series Front, Side and Back View

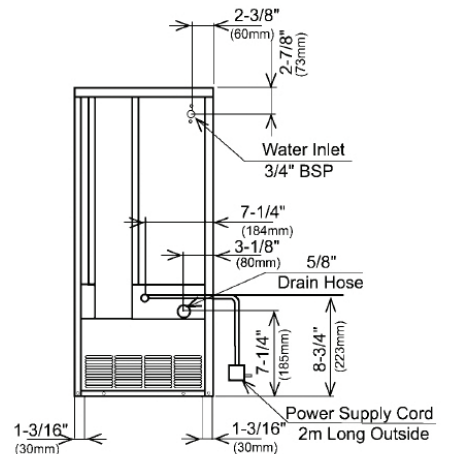
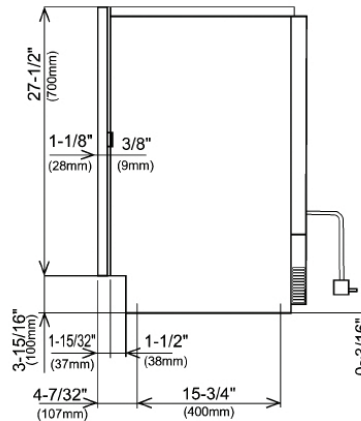
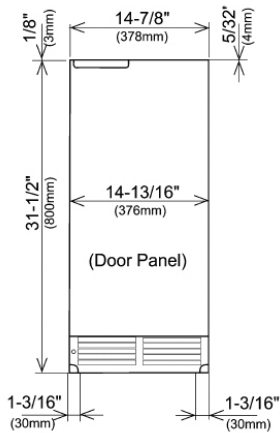

ADA-Height Compliant Series Front, Side and Back View

California Prop 65 Notice:

WARNING: The materials used in this product may contain chemicals known to the State of California to cause cancer and birth defects or other reproductive harm. For more information go to www.P65Warnings.ca.gov.

Form No. Z2548
Rev 11.22.2021