

## Operating and Installation Instructions Speed Oven

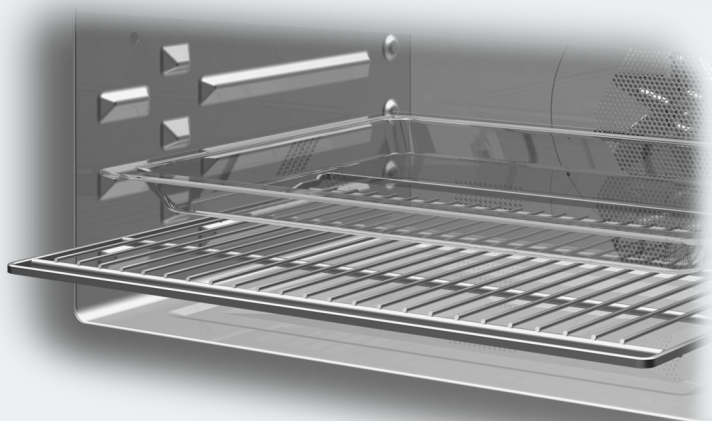

It is **essential** to read the operating and installation instructions before setup, installation, and commissioning. This prevents both personal injury and damage to the appliance.

## **PRECAUTIONS TO AVOID POSSIBLE EXPOSURE TO EXCESSIVE MICROWAVE ENERGY**

---

### **PRECAUTIONS TO AVOID POSSIBLE EXPOSURE TO EXCESSIVE MICROWAVE ENERGY**

- (a) Do not attempt to operate this oven with the door open since open-door operation can result in harmful exposure to microwave energy. It is important not to defeat or tamper with the safety interlocks.
- (b) Do not place any object between the oven front face and the door or allow soil or cleaner residue to accumulate on sealing surfaces.
- (c) Do not operate the oven if it is damaged. It is particularly important that the oven door close properly and that there is no damage to the: (1) Door (bent), (2) hinges and latches (broken or loosened), (3) door seals and sealing surfaces.
- (d) The oven should not be adjusted or repaired by anyone except properly qualified service personnel.

<b>PRECAUTIONS TO AVOID POSSIBLE EXPOSURE TO EXCESSIVE MICROWAVE ENERGY</b> .....	<b>2</b>
<b>IMPORTANT SAFETY INSTRUCTIONS</b> .....	<b>7</b>
<b>Overview</b> .....	<b>18</b>
Guide to the H 7840 BM speed oven.....	18
Guide to the H 7770 BM, H 7870 BM speed oven.....	19
<b>Control panel</b> .....	<b>20</b>
On/Off button .....	21
Proximity sensor (MotionReact) .....	21
Sensor buttons .....	22
Touch display.....	23
Symbols .....	24
<b>Using the appliance</b> .....	<b>25</b>
Selecting a menu option .....	25
Scrolling .....	25
Exiting a menu.....	25
Changing a value or setting.....	25
Changing a setting in a list .....	25
Entering numbers with the roller .....	25
Entering numbers using the numerical keypad .....	25
Changing the setting with a segment bar .....	25
Entering letters .....	26
Displaying the context menu .....	26
Moving entries .....	26
Displaying the pull-down menu.....	26
Displaying Help.....	26
Activating MobileStart.....	26
<b>Features</b> .....	<b>27</b>
Data plate .....	27
Scope of delivery .....	27
Standard and optional accessories .....	27
Safety features.....	30
PerfectClean treated surfaces.....	30
<b>Before first use</b> .....	<b>31</b>
Miele@home .....	31
Basic settings.....	32
Heating the oven for the first time .....	33
<b>Settings</b> .....	<b>34</b>
Settings overview .....	34
Opening the “Settings” menu .....	37

# Contents

---

Language 	37
Time	37
Date	37
Lighting	38
Start screen	38
Display	38
Volume	39
Units of Measurement	39
Quick Microwave	39
Popcorn	39
Booster	39
Recommended temperatures	40
Recommended power levels	40
Cooling fan run-on	40
Proximity sensor (MotionReact)	41
Safety	41
Furniture front recognition	42
Miele@home	42
Remote Control	43
Activating MobileStart	43
SuperVision	43
RemoteUpdate	44
Electrical version	45
Calibrate temperature	45
Software version	45
Legal information	45
Showroom Program	45
Factory default	45
<b>Alarm + Timer</b>	<b>46</b>
Using the Alarm function	46
Using the Timer function	47
<b>Main and submenus</b>	<b>48</b>
<b>Microwave operation</b>	<b>50</b>
How it works	50
Suitable dishware	50
Suitable dishware	51
Unsuitable dishware	53
Testing dishware	53
Cover	54

<b>Operation</b> .....	<b>55</b>
Changing values and settings for a cooking program .....	55
Changing the temperature and core temperature .....	56
Changing the microwave power level .....	56
Setting additional durations .....	56
Changing set durations .....	56
Deleting the set cooking durations .....	56
Interrupting a cooking process in the Microwave operating mode.....	57
Canceling a cooking program .....	57
Preheating the oven .....	57
Booster.....	58
Preheat .....	58
Crisp function.....	59
Changing the operating mode .....	59
<b>Quick Microwave</b> .....	<b>60</b>
<b>Automatic Programs</b> .....	<b>61</b>
Categories .....	61
Using automatic programs.....	61
Usage notes .....	61
Search .....	62
<b>Special Modes</b> .....	<b>63</b>
Defrost .....	64
Dehydrate .....	67
Reheat.....	68
Warm-up Cookware.....	71
Proof.....	71
Keep warm.....	71
Slow Roasting.....	72
Sabbath Program.....	75
Cooking.....	76
Canning.....	78
Frozen food/ready meals.....	80
<b>MyMiele</b> .....	<b>81</b>
<b>Favorites</b> .....	<b>82</b>
<b>Baking</b> .....	<b>85</b>
Tips for baking.....	85
Notes on the operating modes.....	85
<b>Roasting</b> .....	<b>87</b>
Tips for roasting .....	87
Notes on the operating modes.....	88

# Contents

---

Probe .....	89
<b>Broiling .....</b>	<b>91</b>
Tips for broiling .....	91
Notes on the operating modes.....	92
<b>Cleaning and care of the oven.....</b>	<b>93</b>
Unsuitable cleaning agents.....	93
Removing normal soiling.....	94
Removing stubborn soiling.....	95
Lowering the browning/broiling element.....	95
<b>Frequently asked questions.....</b>	<b>97</b>
<b>Customer Service .....</b>	<b>102</b>
Contact in the event of a fault .....	102
Appliance warranty and product registration .....	102
<b>Caring for the environment .....</b>	<b>103</b>
<b>Installation.....</b>	<b>104</b>
Installation dimensions H 7840 BM.....	104
Installation in a tall or base cabinet .....	104
Side view.....	105
Connections and ventilation .....	106
Installation dimensions H 7770 BM, H 7870 BM.....	107
Installation in a tall or base cabinet .....	107
Side view.....	108
Connections and ventilation .....	109
Installing and removing the oven .....	110
Taking the oven out of the housing unit.....	112
Electrical connection .....	113
<b>Declaration of conformity .....</b>	<b>115</b>
<b>Copyrights and licenses .....</b>	<b>116</b>
<b>Copyrights and licenses for the communication module .....</b>	<b>117</b>

# IMPORTANT SAFETY INSTRUCTIONS

**When using the appliance, follow basic safety precautions, including the following:**

**Read all instructions before installation and use of the oven to prevent accidents and machine damage.**

**WARNING - To reduce the risk of burns, electric shock, fire, injury to persons, or exposure to excessive microwave energy:**

This appliance complies with current safety requirements. Improper use of the appliance can lead to personal injury and material damage.

Read all instructions before installing or using the oven for the first time. Only use the appliance for its intended purpose.

Keep these operating instructions in a safe place and pass them on to any future user.

Read and follow the specific “PRECAUTIONS TO AVOID POSSIBLE EXPOSURE TO EXCESSIVE MICROWAVE ENERGY” found at the beginning of this manual.

Only use the appliance for its intended purpose. Install or locate this appliance only in accordance with the provided installation instructions and all local codes.

▶ For the sake of simplicity, the speed oven will subsequently be referred to as the “oven”.

## **Appropriate use**

▶ This oven is intended for domestic use and use in other similar environments.

▶ The oven is not intended for outdoor use.

▶ The oven is intended for cooking food – and, in particular, for baking, roasting, broiling, reheating, defrosting, and drying food – in domestic settings only.

All other types of use are not permitted.

▶ Risk of fire due to flammable materials.

If flammable items are dried using microwave power, the moisture in the items will evaporate. This could cause the materials to dry out and possibly self-ignite.

Never use the oven to store or dry items which could ignite easily.

## IMPORTANT SAFETY INSTRUCTIONS

---

▶ This oven can only be used by people with reduced physical, sensory, or mental capabilities or lack of experience and knowledge if they are supervised while using it.

They may only use it unsupervised if they have been shown how to do so in a safe manner. They must be able to understand and recognize the possible dangers caused by incorrect operation.

▶ The oven compartment is equipped with special bulbs to cope with particular conditions (e.g., temperature, moisture, chemical resistance, abrasion resistance, and vibration). These special bulbs must only be used for the purpose for which they are intended. They are not suitable for room lighting. Replacement bulbs should only be installed by a Miele authorized technician or by Miele Customer Service.

### Safety with children

▶ **HOT CONTENTS CAN CAUSE SEVERE BURNS. DO NOT ALLOW CHILDREN TO USE THE OVEN.**

Use caution when removing hot items.

▶ Activate the system lock to ensure that children cannot switch on the oven inadvertently.

▶ Children should be supervised in the vicinity of the oven. Never allow children to play with the oven.

▶ **Burn Hazard - Do not allow children to use the oven.**

▶ Risk of suffocation from packaging material. While playing, children may become entangled in packaging material (such as plastic wrapping) or pull it over their head, presenting the risk of suffocation.

Keep packaging material away from children.

▶ Risk of injury caused by hot surfaces. Children's skin is far more sensitive to high temperatures than that of adults. External parts of the oven such as the door glass, control panel, and the vent become quite hot.

Do not let children touch the oven when it is in operation.

▶ Risk of injury from the open door. The oven door can support a maximum weight of 17.5 lbs (8 kg). Children could injure themselves on an open door.

Do not let children sit on the door, lean against it, or swing on it.



# IMPORTANT SAFETY INSTRUCTIONS

## Technical safety

- ▶ This appliance must be installed and connected in compliance with the installation instructions.
- ▶ Unauthorized installation, maintenance, and repairs can cause considerable danger for the user. Installation, maintenance, and repairs should only be carried out by a Miele authorized technician.
- ▶ Maintenance by the user: Never repair or replace any part of the appliance unless the instructions specifically recommend doing so. Service work should only be performed by a qualified technician.
- ▶ Damage to the oven can compromise your safety. Check the oven for visible signs of damage. Do not use a damaged oven.
- ▶ Temporary or permanent operation on an autonomous power supply system or a power supply system that is not synchronized with the grid power supply (e.g., island networks, back-up systems) is possible. A prerequisite for operation is that the power supply system complies with national and local codes.  
The function and operation of the protective measures provided in the domestic electrical installation and in this Miele product must also be maintained in isolated operation or in operation that is not synchronized with the grid power supply, or these measures must be replaced by equivalent measures in the installation.
- ▶ Operating a damaged oven can result in microwave leakage and present a hazard to the user. Do not use the oven if:
  - The door is warped.
  - The door hinges are loose.
  - Holes or cracks are visible in the casing, the door, or the oven compartment walls.
- ▶ The electrical safety of this appliance can only be guaranteed when correctly grounded. It is essential that this basic safety requirement is fulfilled. If in doubt, the electrical installation should be checked by a qualified electrician.
- ▶ Proper installation: Make sure that your appliance has been installed correctly and that it has been grounded by a qualified technician.
- ▶ The connection data (voltage and frequency) on the data plate of the oven must match the domestic electrical supply in order to avoid the risk of damage to the oven. Compare this before connecting the appliance to the domestic electrical supply. If in any doubt, consult a qualified electrician.

## IMPORTANT SAFETY INSTRUCTIONS

---

- ▶ Power bars and extension cords do not guarantee the required safety of the appliance. Do not use these to connect the oven to the power supply.
- ▶ For safety reasons, only use the oven when it has been fully installed.
- ▶ This appliance must not be used in a non-stationary location (e.g., on a ship).
- ▶ Risk of injury due to electric shock. Any contact with live connections or tampering with the electrical or mechanical components of the oven will endanger your safety and may lead to appliance malfunctions.  
Do not open the oven housing under any circumstances.
- ▶ While the appliance is under warranty, repairs should only be undertaken by a service technician authorized by Miele Customer Service. Otherwise the warranty will be invalidated.
- ▶ Miele can only guarantee the safety of the appliance when original Miele parts are used. Faulty components must only be replaced with genuine Miele parts.
- ▶ If the oven is delivered without a power cord, a special cord must be installed by a Miele authorized technician (see “Installation – Electrical connection”).
- ▶ If the power cord is damaged, it must be replaced with a special power cord by a Miele authorized technician (see “Installation – Electrical connection”).
- ▶ During installation, maintenance, and repair work, the oven must be completely disconnected from the power supply. To ensure this:
  - The circuit breakers have been switched off, or
  - the fuses of the electrical installation have been completely removed, or
  - the plug (if present) is removed from the outlet. To do this, pull the plug not the cord.
- ▶ The oven requires a sufficient supply of cool air for efficient operation. Make sure that the supply of cool air is not hindered in any way (e.g., by installing heat insulation strips in the cabinet niche). In addition, the required supply of cool air must not be excessively heated by other heat sources.

## IMPORTANT SAFETY INSTRUCTIONS

---

▶ If the oven is built in behind a cabinet door front, do not close the cabinet door while the oven is in use. Heat and moisture can build up behind the cabinet door when closed. This can result in damage to the oven, cabinet niche, and floor. Leave the cabinet door front open until the oven has cooled down completely.

### **Correct use**

▶ **Caution:** Heating elements may be hot even though they are not glowing. Interior surfaces of an oven become hot enough to cause burns. External parts of the oven such as the door glass, vents, and the control panel can become hot. During and after use, do not touch, or let clothing or other flammable materials come into contact with heating elements or interior surfaces of the oven until they have had sufficient time to cool.

▶ Do not let food sit in the oven for an extended period of time before or after cooking. Doing so can result in food poisoning or sickness.

▶ Loose fitting or hanging garments present a fire hazard. Wear proper apparel while operating the appliance.

▶ Use only dry, heat-resistant potholders. Moist or damp potholders used on hot surfaces may result in steam burns. Do not let potholders come in contact with oil or grease. Do not substitute dish towels or other bulky items for potholders. Do not let potholders touch hot heating elements.

▶ Open the door carefully to allow hot air or steam to escape before placing or removing food.

▶ To prevent burns, always place oven racks at their desired height while the oven is cool. If the rack must be moved while the oven is hot, do not let pot holders touch hot heating elements.

▶ To prevent burns, allow the heating elements to cool before cleaning by hand.

▶ Smother the fire or flames, or use a dry chemical extinguishing agent or foam fire extinguisher.

▶ Never store flammable liquids and materials in, above or under an oven, or near cooking surfaces.

## IMPORTANT SAFETY INSTRUCTIONS

### WARNING

NEVER use this appliance as a space heater to heat or warm the room. Doing so may result in carbon monoxide poisoning and overheating of the oven.

### WARNING





NEVER use this appliance as storage space. Doing so may result in carbon monoxide poisoning and overheating of the oven.

### WARNING

NEVER cover any slots, holes or openings in the oven bottom or cover an entire rack with materials such as aluminum foil. Doing so blocks air flow through the oven and may cause carbon monoxide poisoning. Aluminum foil linings may also trap heat, causing a fire hazard.

- ▶ Do not obstruct the flow of combustion and ventilation air.
- ▶ This oven must only be used for cooking food. Corrosive chemicals and vapors as well as fumes, vapors or heat given off by glues, plastics or flammable liquids and materials could be hazardous. Do not use it as a dryer, kiln, dehumidifier, etc.
- ▶ Do not let metal objects (aluminum foil, pans) come in contact with the heating element.
- ▶ Make certain that the power cords of small appliances do not come in contact with or get caught in the oven door.
- ▶ Risk of injury caused by hot surfaces. The oven gets hot during operation. You could burn yourself on the heating elements, oven compartment, accessories, or food.  
When the oven is hot, use pot holders to insert, remove, or turn food, as well as when adjusting the oven shelves, etc.
- ▶ To avoid fueling any flames, do not open the oven door if smoke appears inside the appliance. Interrupt the process by turning the appliance off and disconnecting it from the power. Do not open the door until the smoke has dissipated.
- ▶ Due to the high temperatures radiated, objects left near the oven could catch fire. Do not use the oven to heat up the room.

## IMPORTANT SAFETY INSTRUCTIONS

- ▶ Oils and fats are a fire hazard if allowed to overheat. Never leave the oven unattended when cooking with oil or fats. Never attempt to put out oil or fat fires with water. Turn the oven off and extinguish the flames by leaving the door closed.
- ▶ Broiling food for excessively long cooking durations can cause it to dry out with the risk of catching fire. Do not exceed the recommended cooking durations.
- ▶ Please be aware that durations when using microwave power are often considerably shorter when cooking, reheating, and defrosting than when using operating modes without microwave power. Excessively long cooking durations can lead to food drying out and burning, or could even cause it to catch fire. Do not exceed recommended broiling durations when using broiling operating modes. Do not use the Microwave  operating mode to dry flowers or herbs, or to crisp up bread or rolls. Never use a broiling operating mode to dry flowers, herbs, or similar. Use the Convection Bake/Convection Roast  or Surround  operating mode and always ensure this type of procedure is supervised.
- ▶ If using alcohol in your recipes, please be aware that high temperatures can cause the alcohol to evaporate. The vapor can catch fire on hot heating elements.
- ▶ When using residual heat to keep food warm, corrosion from high air humidity and condensation can occur in the oven. This can cause damage to the control panel, countertop, and cabinet carcass. Keep the oven on and select the lowest temperature available for the selected operating mode. The cooling fan will then continue to run automatically.
- ▶ Food which is stored in the oven compartment or left in it to be kept warm can dry out and the moisture released can lead to corrosion damage in the oven. Always cover food that is left in the oven to keep warm.
- ▶ A buildup of heat can cause damage to the oven. Never line the floor of the oven with aluminum foil or oven liners. If you wish to place dishware on the floor of the oven during the cooking process, or place dishware on the floor of the oven to heat it up, you can do so, but only with the Convection Bake/Convection Roast  operating mode, without the Booster function.
- ▶ The oven floor can become damaged by items being pushed around on it. When placing pots, pans, or dishware on the oven floor, do not push them around.

## IMPORTANT SAFETY INSTRUCTIONS

---

- ▶ Risk of injury caused by steam. Pouring a cold liquid onto a hot surface creates steam, which can cause severe scalding. The sudden temperature change can also cause damage to hot surfaces. Never pour cold liquids directly onto hot enameled surfaces.
- ▶ The oven is not suitable for cleaning or disinfecting items. Items can get extremely hot. There is a risk of burning when items are removed from the oven.
- ▶ It is important that the temperature in the food being cooked is evenly distributed and sufficiently high. You can ensure this by stirring or turning the food, and observing a sufficiently long standing time (see charts), which should be added to the time needed for reheating, defrosting, or cooking. During the standing time, the temperature is distributed evenly in the food.
- ▶ When heating food, and in particular liquids, using the Microwave  operating mode, the boiling point may be reached without the typical bubbles being produced. The liquid does not boil evenly throughout. This boiling delay can result in the liquid boiling over explosively. Take care when taking the container out of the oven, as the hot liquid can cause severe scalding. Under certain circumstances, the pressure can be so high that the door opens automatically. Stir liquids well before heating or cooking. After heating, wait at least 20 seconds before removing the container from the oven. In addition, you can place a glass rod or similar item, if available, in the container during the heating process.
- ▶ Risk of injury caused by hot food. When you heat food up, the heat is created directly in the food itself. For this reason, the dishware will remain cooler than the food (except when you use ovenproof stoneware). The dishware is only warmed by the heat of the food. Before serving, always check the temperature of the actual food itself after taking it out of the oven. The temperature of the container is not an indication of the temperature of the food or liquid in it. **This is particularly important when preparing food for babies, children, and the elderly or infirm.** After heating food, especially food for babies and small children, stir the food or shake the container and check that the temperature does not pose any danger of burning. Double check after it has been left to stand.

## IMPORTANT SAFETY INSTRUCTIONS

▶ Risk of injury from increased pressure in sealed containers or bottles. Pressure can build up when reheating food or drinks in sealed containers or bottles, which can cause them to explode. Never cook or reheat food or liquids in sealed containers or bottles. Open containers beforehand and with baby bottles, the screw top and nipple must be removed.

▶ If you cook eggs without their shells, the yolks could explode due to the resulting pressure.

Prick the yolk several times before cooking to avoid this.

▶ Eggs heated in their shell can burst, even after they have been removed from the oven.

Eggs can only be cooked in their shells in a specially designed egg-boiling device. Do not reheat hard-boiled eggs using the

Microwave  operating mode.

▶ Food with a thick skin or peel, such as tomatoes, sausage, potatoes, and eggplant can burst when heated or cooked.

Pierce or score the skin of these foods several times to allow steam to escape.

▶ Do not use a thermometer containing mercury or liquid as these are not suitable for use with very high temperatures and break very easily. Only use the Miele probe supplied with the appliance to measure the temperature of the food.

▶ Cushions or pads filled with cherry kernels, gel, etc., such as those used in aromatherapy, can ignite when heated, even after they have been removed from the oven.

Do not heat these up in the oven.

▶ Moisture can collect in the hollow spaces on dishware and lids with hollow handles or knobs. When the moisture evaporates, pressure can build up and the item can explode. If the hollow recess is sufficiently ventilated, the item can be used.

Do not use dishware with hollow knobs or handles when using the Microwave  operating mode.

▶ Non-microwave-safe plastic dishes can suffer damage or damage the oven if used with the Microwave  operating mode and microwave operating modes.

Do not use any containers or cutlery made from or containing metal, aluminum foil, lead crystal glassware, temperature-sensitive plastics, wooden utensils or cutlery, metal clips, or plastic or paper-covered wire ties. Do not use bowls with milled rims, or plastic pots with the foil lid only partially removed (see the requirements specified for dishware in the section on microwave operation).

## IMPORTANT SAFETY INSTRUCTIONS

---

▶ Plastic containers which are not heat-resistant melt and may ignite at high temperatures and can damage the oven.

Use only plastic containers that are suitable for use in an oven when using operating modes that do not use microwave power. Follow the manufacturer's instructions.

▶ Fire hazard due to containers made of flammable materials. Plastic disposable containers must meet the requirements specified for dishware in the section on microwave operation.



Do not leave the oven unattended when heating or cooking food in disposable containers made of plastic, paper, or other flammable materials.

▶ Heat-retaining bags usually contain a thin layer of aluminum foil that reflects microwave radiation. As a result, the paper surrounding the aluminum foil can become so hot that it combusts.

Do not use heat-retaining packaging, such as bags for roasted chicken, for warming food with operating modes that use microwave power.

▶ If the oven is used without food or the food is loaded incorrectly when using the Microwave  operating mode or operating modes that use microwave power, the oven can become damaged.

**Always** use the glass tray with the Microwave  operating mode, even if you use it as a shelf for smaller dishes.

Do not use any operating modes that use microwave power to preheat dishware or to dry herbs. Instead, use the Convection Bake  or Surround  operating modes.

▶ Canning food and heating it up in closed containers results in an increase in pressure which can cause them to explode. Do not use cans for canning or reheating food.

▶ Risk of injury from the open door. You could bang into the open door or trip over it. Do not leave the door open unnecessarily.

▶ The door can support a maximum load of 17.5 lbs (8 kg). Do not lean or sit on an open door, or place heavy items on it. Make sure that nothing gets trapped between the door and the oven compartment. This could damage the oven.

### The following applies to stainless steel surfaces:

▶ Adhesives will damage the coated stainless steel surface and cause it to lose its dirt-repellent protective coating. Do not use sticky notes, adhesive tape, or other types of adhesive on the stainless steel surface.



## IMPORTANT SAFETY INSTRUCTIONS

---

▶ Magnets can cause scratches. Do not use the stainless steel surface as a magnetic notice board.

### Cleaning and care

▶ Risk of injury due to electric shock. The steam from a steam cleaning appliance could reach live electrical components and cause a short circuit. Never use a steam cleaner for cleaning.

▶ Only clean parts listed in these operating and installation instructions.

▶ Scratches on the door glass can cause the glass to break. Do not use abrasive cleaners, hard sponges, brushes, or sharp metal tools to clean the door glass.

▶ Try to prevent the interior walls being splashed with food containing salt. If this does happen, wipe it away thoroughly to avoid corrosion to stainless steel surfaces inside the oven compartment.

▶ In warm, moist environments, there is a higher probability of pest infestations. Ensure the oven and the area surrounding it are always kept clean.

Damage caused by pests is not covered by the warranty.

### Accessories

▶ Only use original Miele accessories. Using parts or accessories from other manufacturers will invalidate the warranty, and Miele cannot accept liability.

▶ Only use the Miele probe supplied with the appliance. If it is faulty, it must be replaced with a new original Miele probe.

▶ The plastic on the probe can melt at very high temperatures. Do not use the probe when using the broiling operating modes. Do not store the probe in the oven compartment when it is not being used.

**KEEP THE OPERATING AND INSTALLATION INSTRUCTIONS IN A SAFE PLACE AND REVIEW THEM PERIODICALLY.**

# Overview

---

## Oven

### Guide to the H 7840 BM speed oven

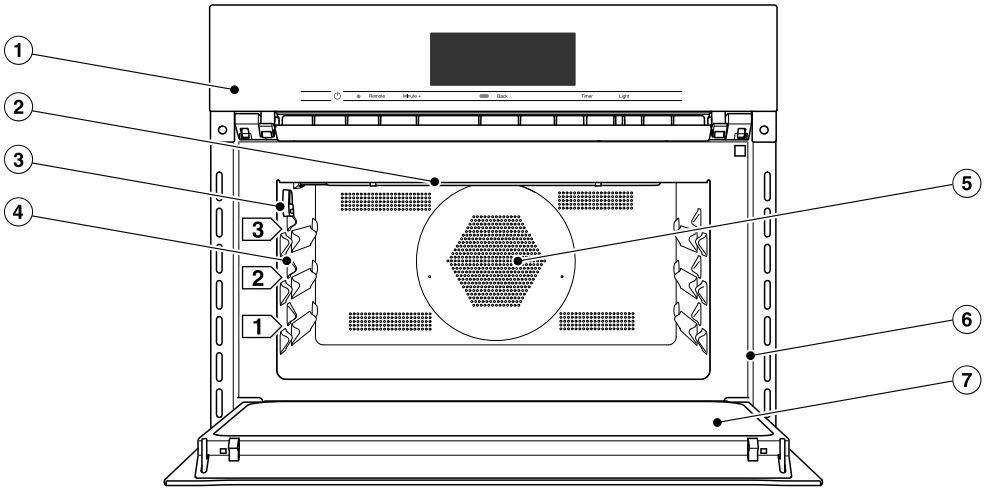

- ① Controls
- ② Browning/Boiling element
- ③ Connection socket for the probe
- ④ 3 shelf levels for the glass tray and wire rack
- ⑤ Convection fan with heating element
- ⑥ Front frame with data plate
- ⑦ Door

## Guide to the H 7770 BM, H 7870 BM speed oven

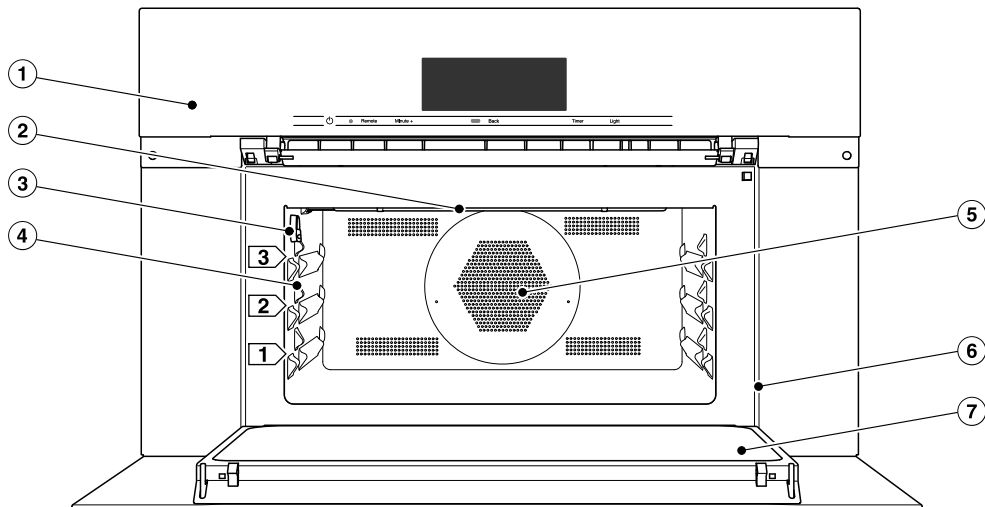

- ① Controls
- ② Browning/Broiling element
- ③ Connection socket for the probe
- ④ 3 shelf levels for the glass tray and wire rack
- ⑤ Convection fan with heating element
- ⑥ Front frame with data plate
- ⑦ Door

# Control panel

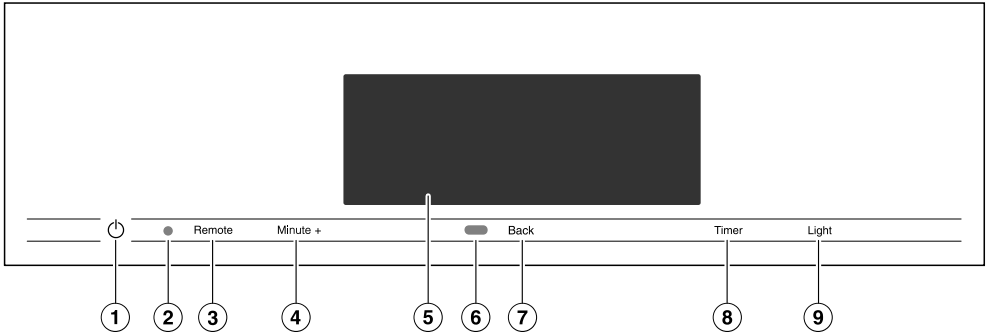

- ① Recessed  On/Off button  
For turning the oven on and off
- ② Optical interface  
(for Miele Service only)
- ③ *Remote* sensor button  
For controlling the oven via your mobile device
- ④ *Minute +* sensor button  
For starting the Quick Microwave function
- ⑤ Touch display  
For displaying information and for operation
- ⑥ Proximity sensor (MotionReact)  
For turning on the oven interior lighting and the display when approached, and to dismiss the audible signal when movement is detected
- ⑦ *Back* sensor button  
To go back a step
- ⑧ *Timer* sensor button  
To activate or deactivate timers or alarms
- ⑨ *Light* sensor button  
For switching the oven interior lighting on and off

### **On/Off button**

The  On/Off button is recessed and reacts to touch.

Use this button to turn the oven on and off.

### **Proximity sensor (MotionReact)**

The proximity sensor detects when you approach the touch display, e.g., with your hand or body.

If you have activated the corresponding settings, you can turn on the oven interior lighting, turn on the oven, or acknowledge the audible signals (see “Settings – Proximity sensor (MotionReact)”).

# Control panel

## Sensor buttons

The sensor buttons react to touch. Every tap of a sensor button is confirmed with an audible keypad tone. You can turn this keypad tone off by selecting the [Volume | Keypad Tone | Off](#) setting.

If you want the sensor buttons to respond even when the oven is turned off, select the [Display | QuickTouch | On](#) setting.

Sensor button	Function
<i>Remote</i>	<p>If you want to control the oven from your mobile device, you must have the Miele@home system, turn on the <a href="#">Remote Control</a> setting, and tap this sensor button. The sensor button then lights up and the MobileStart function is available.</p> <p>As long as this sensor button is illuminated, you can control the oven via your mobile device (see “Settings – Miele@home”).</p>
<i>Minute +</i>	<p>Use this sensor button to start the <a href="#">Quick Microwave</a> function. The cooking process runs with the maximum power level (level 7) and a cooking duration of 1 minute (see section “Quick Microwave”). Touching the sensor button repeatedly increases the cooking duration in increments.</p> <p>This function can only be used when no other cooking processes are in use.</p>
<i>Back</i>	<p>Depending on which menu you are in, this will take you back a level or back to the main menu.</p>
<i>Timer</i>	<p>If a menu appears on the display or if a cooking process is in progress, you can use this sensor button to set a timer (e.g., when boiling eggs) or an alarm (a specific time) at any point (see “Alarm + timer”).</p>
<i>Light</i>	<p>Select this sensor button to turn the oven interior lighting on and off.</p> <p>Depending on the setting selected, the oven interior lighting turns off after 15 seconds or remains constantly turned on or off.</p>

## Touch display

The sensitive surface of the touch display can be scratched by pointed or sharp objects, e.g., pens.

Only touch the display with your fingers.

Make sure that water cannot get behind the touch display.

The touch display is split into multiple areas.

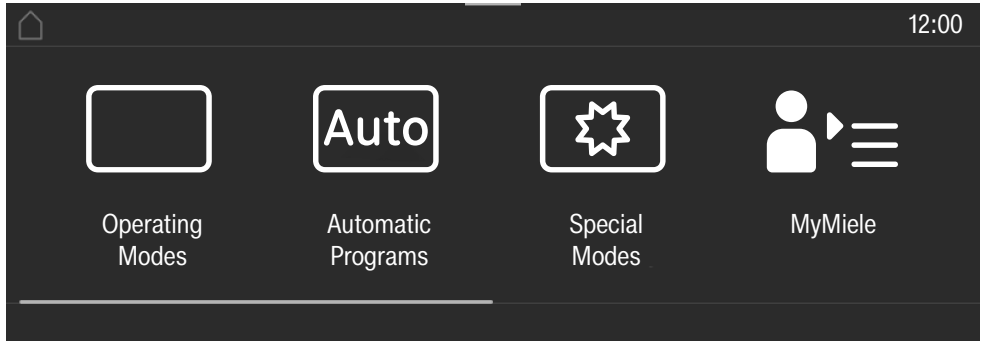

The menu path appears on the left of the **header**. The individual menu options are separated by a vertical line. ... I indicates that there are more menu options available if the menu path can no longer be displayed because there is not enough space on the display.

If you tap a menu name in the header, the display will switch to that menu. To switch to the start screen, tap .

The time of day is shown on the right of the header. You can set the time of day by tapping the display.

Additional symbols may also appear, e.g., SuperVision .

At the top of the header, there is an orange line where you can drag down the pull-down menu. This allows you to turn settings on or off during a cooking process.

The current menu and menu options are shown in the **center** of the display. You can scroll to the right or left by swiping your finger across the display to the right or left. Tap a menu option to select it (see “Using the appliance”).

The operation fields that appear in the **footer** vary according to the menu that is selected; e.g., Timer, Save or OK.

# Control panel

---

## Symbols

The following symbols may appear on the display:

Symbol	Meaning
	This symbol indicates that there is additional information and advice about using the appliance. Select <i>OK</i> to confirm the information.
	This indicates that there are more menu options available, which are not visible because there is not enough space on the display.
	Alarm
	Timer
	Some settings, e.g., display brightness and signal tone volume, are selected using a segment bar.
	The system lock or sensor lock is on (see “Settings – Safety”). The controls are locked.
	Core temperature when using the probe
	Remote control (only appears if you are in the Miele@home system and have selected the Remote Control   On setting)
	SuperVision (only appears if you are in the Miele@home system and have selected the SuperVision   SuperVision display   On setting)



You operate the oven via the touch display by tapping the menu option you want.

Each time you tap a possible option, the relevant characters (word and/or symbol) will light up **orange**.

Fields for confirming an operating step are highlighted in **green** (e.g., *OK*).

## Selecting a menu option

- Tap the field or value you want on the display.

## Scrolling

You can scroll left or right.

- Swipe across the screen. To do this, place your finger on the touch display and swipe it in the desired direction.

The bar at the bottom shows you where you are in the current menu.

## Exiting a menu

- Tap the *Back* sensor button or tap the ... I symbol in the menu path.
- Tap the  symbol to switch to the start screen.

Entries made before this which have not been confirmed with *OK* will not be saved.

## Changing a value or setting

### Changing a setting in a list

The current setting is highlighted in orange.

- Tap the desired setting.

The setting is now saved. This will take you back to the previous menu.

### Entering numbers with the roller

- Swipe the roller up or down until the desired value is displayed in the center.
- Confirm with *OK*.

The changed number is now saved.

### Entering numbers using the numerical keypad

- Tap on the value that is in the middle of the numerical keypad.

The numerical keypad appears.

- Tap the required numbers.

As soon as you enter a valid value, *OK* will turn green.

Use the arrow to delete the last entered number.

- Confirm with *OK*.

The changed number is now saved.

### Changing the setting with a segment bar

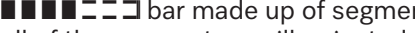
Some settings are represented by a  bar made up of segments. If all of the segments are illuminated, the maximum value is selected.

If none of the segments are illuminated or if only one is, the minimum value is selected or the setting is turned off altogether (e.g., audible signals).

- Tap the corresponding segment on the segment bar to change the setting.
- Select *On* or *Off* to turn the setting on or off.
- Confirm your selection with *OK*.

The setting is now saved. This will take you back to the previous menu.

# Using the appliance

---

## Entering letters

Letters are entered using a display keyboard. It is best to select short names.

- Tap the letters or characters you want.

**Tip:** You can add a line break for longer program names using the ↵ symbol.

- Tap **Save**.

The name is now saved.

## Displaying the context menu

In some menus you can display a context menu, e.g., to rename **Favorites** or to move entries under **MyMiele**.

- For example, tap a **Favorite** and keep your finger on it until the context menu opens.
- To close the context menu, tap an area of the display located outside of the menu window.

## Moving entries

You can change the order of **Favorites** or entries under **MyMiele**.

- For example, tap a **Favorite** and keep your finger on it until the context menu opens.
- Select **Move**.
- Keep your finger on the highlighted field and drag it to the location you want.

## Displaying the pull-down menu

During a cooking program, you can turn settings such as **Booster** or **Preheat** and the **WiFi** function on or off.

- Use the orange line under the header to drag the pull-down menu down.
- Select the setting you want to change.  
Active settings are highlighted in orange. Depending on the selected color scheme, inactive settings are highlighted either in black or white (see “Settings – Display”).
- To close the pull-down menu, drag it back up to the top or tap an area of the display located outside of the menu window.

## Displaying Help

Context-sensitive help is available for certain functions. In this case, **Help** appears in the bottom line.

- Tap **Help** to display information in text and pictures.
- Tap **Close** to return to the previous menu.

## Activating MobileStart

- Select the *Remote* sensor button to activate **MobileStart**.

The *Remote* sensor button lights up. You can operate your oven remotely with the Miele app.

Directly operating on the oven takes priority over operating it via the remote control function on the app.

You can use **MobileStart** as long as the *Remote* sensor button is lit up.

A list of the models described in these operating and installation instructions can be found on the back page.

## Data plate

The data plate located on the front frame of the oven is visible when the door is open.

The data plate states the model number, the serial number, and connection data (voltage, frequency, and maximum rated load).

Have this information available if you need to contact Miele so that any issues can be rectified as quickly as possible.

## Scope of delivery

- Operating and installation instructions for using the oven and microwave functions
- Precision probe
- Screws for securing the oven to the cabinet niche
- Various accessories

## Standard and optional accessories

This oven is supplied with a glass tray, a wire rack, and a food probe.

All accessories and cleaning agents and care products in these instructions are designed to be used with Miele Ovens.

These can be ordered from the Miele web store, Miele Customer Service, or from your Miele dealer.

When ordering, please have the model identifier of your oven ready along with the desired accessories.

### Glass tray

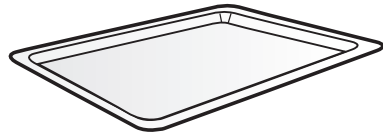

The glass tray is suitable for use with all operating modes.

The glass tray can be damaged by large temperature fluctuations. Do not place the hot glass tray on a cold surface, such as a tiled or granite countertop. Use a suitable mat or pot rest.

- **Always** use the glass tray with the Microwave  operating mode, even if you use it as a shelf for smaller dishes.
- The maximum load for the glass tray is 17.5 lb (8 kg).

## Features

### Wire rack with non-tip safety notches

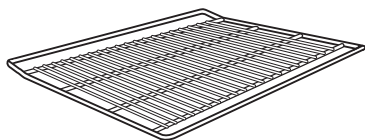

The wire rack is **not** suitable for use with the Microwave  operating mode. You can use the wire rack for all other operating modes which use or do not use microwave power.

 Danger of injury caused by hot surfaces.

The wire rack gets hot during cooking processes.

Use pot holders when placing food in the appliance or removing it and when working in the hot oven cavity.

The oven and wire rack can be damaged by the possible creation of sparks.

Do not use the wire rack for cooking processes with the Microwave  operating mode.

Do not place the wire rack on the oven floor. Place it on one of the shelf levels.

### Using the wire rack

The wire rack has non-tip safety notches. These prevent it being pulled right out when it only needs to be pulled out partially.

If you insert the wire rack the wrong way round, the non-tip safety mechanism is not guaranteed.

When pushing the wire rack back in, always ensure that the safety notches are at the **back** of the oven.

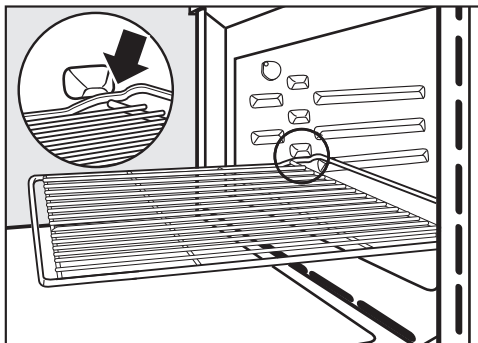



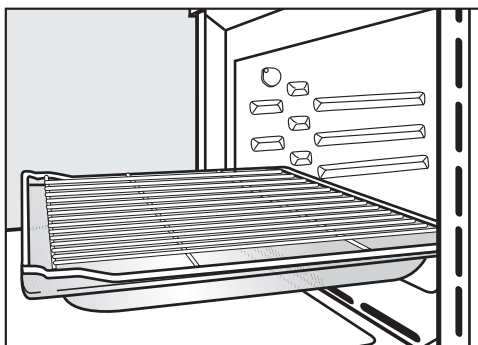

- To remove the wire rack, lift it upwards slightly at the front when the safety notches connect with the sides of the oven.



- It is recommended to use the wire rack together with the glass tray when cooking items on the rack which might drip. Only in this case should the safety notches be at the front.
- The maximum load for the wire rack is 17.6 lb (8 kg).

## Round baking pans

Round baking trays can suffer damage when subjected to microwaves.

Do not use round baking trays with the Microwave , Combi Auto Roast , Combi Conv Bake/Combi Conv Roast , Combi Broil , or Combi Conv Broil  operating modes.



The **solid round baking pan HBF 27-1** is suitable for cooking pizzas, flat cakes made with yeast, or whisked mixtures, sweet and savory tarts, baked desserts, flat bread, and can also be used for frozen cakes and pizzas.

The **perforated round baking and AirFry pan HBFP 27-1** can be used for the same purposes as the **perforated Gourmet baking and AirFry tray HBBL 71**.

The enameled surface of both bakeware pans has been treated with PerfectClean.

- Insert the wire rack and place the round baking pan on the wire rack.

## Probe

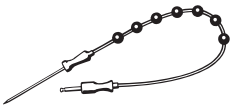

Using the probe enables you to accurately monitor the temperature during the cooking process (see "Roasting – Probe").

## HUB Gourmet Casserole Dishes HBD Gourmet Casserole Dish lids

Gourmet Casserole Dishes and their lids can suffer damage when subjected to microwaves. Metal reflects the microwaves which can create sparks and the microwaves are not absorbed by the metal.

Only use the casserole dishes and their lids for cooking processes with operating modes which **do not use** microwave power.

Insert the wire rack in shelf level 1 and place the Gourmet Casserole Dish on the wire rack.

The surface of the Gourmet Casserole Dishes has a non-stick coating and is suitable for induction cooktops.

Gourmet Casserole Dishes are available in different depths. The width and the height are the same.

Suitable lids are available separately. Please quote the model designation when ordering.

**Depth:**  
**8 1/2" (22 cm)**

HUB 62-22

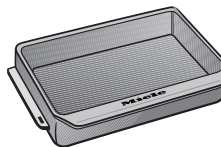

HBD 60-22

**Depth:**  
**13 3/4" (35 cm)\***

HUB 62-35

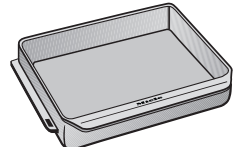

HBD 60-35

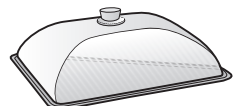
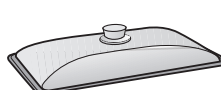

- \* The casserole dish cannot be used in conjunction with this lid in ovens with 3 shelf levels because the total height would exceed the height of the oven cavity.

# Features

---

## Safety features

- **System lock**   
(see “Settings – Safety”)
- **Sensor lock**  
(see “Settings – Safety”)
- **Cooling fan**  
(see “Settings – Cooling fan run-on”)
- **Safety shut-off**  
An operating mode which does not use microwave power can be started without selecting a cooking duration. To prevent continuous use and avoid the risk of fire, the oven will switch itself off automatically after a certain time has elapsed following the last operation, depending on the operating mode and temperature selected.

## PerfectClean treated surfaces

PerfectClean surfaces have very good non-stick properties making them exceptionally easy to clean.

Food can be easily removed from these surfaces. Soiling from baking and roasting can also be easily removed from these surfaces.

However, do not use ceramic knives as these will scratch the PerfectClean surface.

Read the instructions in “Cleaning and care of the oven” to retain the benefits of the non-stick properties and easy cleaning.

PerfectClean treated surfaces:

- Oven cavity
- Wire rack
- Round perforated baking and AirFry tray
- Round baking pan

## Miele@home

Your oven is equipped with an integrated WiFi module.

To use this feature, you will need:

- A WiFi network
- The Miele app
- A Miele user account. You can create a user account via the Miele app.

The Miele app will guide you as you connect your oven to your home WiFi network.

Once your oven is connected to your WiFi network, you can use the app to carry out various activities, such as:

- Call up information on the operating status of your oven
- Retrieve information on cooking processes that are in progress
- Stop cooking programs that are in progress

Connecting your oven to your WiFi network will increase energy consumption, even when the oven is turned off.

Make sure that the signal of your WiFi network is sufficiently strong in the place where your oven is installed.

## Availability of the Wi-Fi connection

The Wi-Fi connection shares a frequency range with other appliances (including microwave ovens and remote control toys). This can cause sporadic or even complete connection failures. Therefore, the availability of featured functions cannot be guaranteed.

## Miele@home availability

The ability to use the Miele app depends on the availability of the Miele@home service in your country.

The Miele@home service is not available in every country.

For information about availability, please visit [www.miele.com](http://www.miele.com).

## Miele App

The Miele App is available to download free of charge from the Apple App Store® or from the Google Play Store™.



# Before first use

---

## Basic settings

You must make the following settings before starting up for the first time. You can change these settings again at a later time (see “Settings”).

 Risk of injury caused by hot surfaces.  
The oven gets hot during operation.  
For safety reasons, only use the oven when it has been fully installed.

The oven will turn on automatically when it is connected to the electrical supply.

## Setting the language

- Select the desired language.

If you have accidentally selected a language that you don't understand, proceed as described in “Settings – Language ”.

## Setting the location

- Select the required location.

## Setting up Miele@home

Set up Miele@home? will appear on the display.

- To set up Miele@home immediately, select *Continue*.
- To set it up at a later date, select *Skip*. See “Settings – Miele@home” for information on setting up at a later date.

- To set up Miele@home immediately, select the connection method you want to use.

You will then be guided by the display and the Miele app.

## Setting the date

- Set the day, then the month, and finally the year.
- Confirm with *OK*.

## Setting the time

- Set the time of day in hours and minutes.
- Confirm with *OK*.

## Setting the voltage

 The set voltage variant must match the voltage of the domestic electrical supply in order to avoid the risk of damage to the oven.  
Confirm the voltage before setting. If in any doubt, consult a qualified electrician.

- Select the voltage variant.
- Confirm with *OK*.

## Completing the commissioning process

- Follow any further instructions on the display.

The appliance is now ready for use.





### Heating the oven for the first time

New ovens may have a slight odor when they are heated up for the first time. This can be eliminated by heating the empty oven for at least an hour.

Ensure that the kitchen is well ventilated while the appliance is being heated up for the first time. Close doors to other rooms to prevent the odor spreading throughout the house.

- Remove any adhesive labels or protective films from the ovens and accessories.
- Take all accessories out of the oven cavity and clean them (see “Cleaning and care”).
- Before heating the oven up, wipe the interior with a damp cloth to remove any dust or bits of packaging that may have accumulated in the oven cavity.
- Turn the oven on using the  On/Off button.

The main menu will appear.

- Select Operating Modes .
- Select Convection Bake .

350°F (160°C) will appear as a recommended value.

The oven heating, lighting, and cooling fan will turn on.

- Set the highest possible temperature.
- Confirm with *OK*.

Heat up the oven for at least an hour.

- After at least an hour, turn the oven off with the  On/Off button.

### Cleaning the oven cavity after heating it up for the first time

 Danger of injury caused by hot surfaces.

The oven gets hot during operation. You could burn yourself on the heater elements and the oven cavity.





Allow the heater elements and oven cavity to cool before manual cleaning.

- Clean the oven cavity with warm water and liquid dish soap, applied with a soft sponge or microfiber cloth.
- Dry all surfaces with a soft cloth.

Leave the oven door open until the oven cavity is completely dry.

# Settings

## Settings overview

Menu option	Available settings
Language 	...   deutsch   english   ... Location
Time	Display On*   Off   Night dimming Clock type Analog*   Digital Clock format 24 h   12 h (am/pm)* Set
Date	
Lighting	On "On" for 15 seconds* Off
Start screen	Main menu* Operating modes Automatic Programs Special Modes Favorites MyMiele
Display	Brightness  Color scheme Bright   Dark* QuickTouch On   Off*
Volume	Buzzer Tones  Keypad Tone  Welcome Melody On*   Off

\* Factory default

Menu option	Available settings
Units of Measurement	Weight g   lb*   lb/oz Temperature °C   °F*
Quick Microwave	Power Level Duration
Popcorn	Duration
Booster	On* Off
Recommended temperatures	
Recommended power levels	
Cooling fan run-on	Time controlled Temperature controlled*
MotionReact	Switch the light on during cooking program*   always on   Off Switch the appliance on On   Off* Acknowledge buzzer On*   Off
Safety	System Lock  On   Off* Sensor Lock On   Off*
Furniture front recognition	On Off*
Miele@home	Activate Deactivate Connection status Set up again Reset Set up
Remote Control	On* Off

\* Factory default

# Settings

Menu option	Available settings
SuperVision	SuperVision display On   Off* Display in standby On*   Only if there is a fault Appliance list Display this Appliance   Buzzer Tones
RemoteUpdate	On* Off
Electrical version	208V / 60Hz 220V / 60Hz 240V / 60Hz
Calibrate temperature	
Software version	
Legal information	Open Source Licenses
Showroom Program	Demo Mode On   Off*
Factory default	Appliance settings Favorites MyMiele Recommended power levels Recommended temperatures

\* Factory default

## Opening the “Settings” menu

In the  Settings menu, you can personalize your oven by adapting the factory default settings to suit your requirements.

From the main menu:

- Select  Settings.
- Select the setting you want.



You can check settings or change them.

You cannot change settings while a cooking process is in progress.

## Language

You can set your language and location.

After selecting and confirming your choice, the language you have selected will appear on the display.

**Tip:** If you have accidentally selected a language that you don't understand, select  in the main menu. Follow the  symbol to get back to the Language  submenu.

## Time

### Display

Select how you want the time of day to show on the display when the oven is turned off:

- On  
The time is always visible on the display.  
If you also select the Display | QuickTouch | On setting, all sensor buttons will react to touch straight away and the proximity sensor will automatically detect when you approach the display.  
If you also select the Display | QuickTouch | Off setting, the oven has to be turned on before it can be used.

- Off  
The display appears dark to save energy. The oven has to be turned on before you can use it.
- Night dimming  
To save energy, the time only shows on the display between 5:00 a.m. and 11:00 p.m. The display remains dark at all other times.

### Clock type

The time of day can be displayed as Analog (with a clock face) or Digital (h:min) format.

With the digital display, the date is also shown.

### Clock format

The time of day can be displayed in the 24 or 12-hour format (24 h or 12 h (am/pm)).

### Set

Set the hours and the minutes.

**Tip:** If no cooking program is in progress, tap the time in the header to change it.

If there is a power failure, the current time of day will reappear once the power has been restored. The time of day is saved for approx. 150 hours.

If the oven has been connected to a WiFi network and signed into the Miele app, the time will be synchronized based on the location setting in the Miele app.

### Date

Set the date.

# Settings

---

When the oven is turned off, the date will only appear on the display if the Time | Clock type | Digital setting has been selected.

## Lighting

- On  
The oven interior lighting is turned on during the entire cooking process.
- "On" for 15 seconds  
The oven interior lighting turns off 15 seconds after a cooking process has begun. Press the *Light* sensor button to turn the oven interior lighting on again for 15 seconds.
- Off  
The oven interior lighting is turned off. Press the *Light* sensor button to turn the oven interior lighting on for 15 seconds.

## Start screen

The oven is set at the factory for the main menu to appear when the oven is turned on. You can change this default setting so that, for instance, the operating modes or MyMiele settings appear on the start screen (see "MyMiele").

This new start screen will then appear when the oven is next turned on.

Select the *Back* sensor button or follow the path in the header to get to the main menu.

## Display

### Brightness

The display brightness is represented by a segment bar.

- ■■■■■■■■  
Maximum brightness
- ■■■■■■■  
Minimum brightness

### Color scheme

Choose between a light or dark color scheme for the display.

- Bright  
The display has a light background with dark characters.
- Dark  
The display has a dark background with light characters.

### QuickTouch

Select how the sensor buttons and the proximity sensor should respond when the oven is turned off:

- On  
If you have also selected the Time | Display | On or Night dimming setting, the sensor buttons and the proximity sensor will also respond when the oven is turned off.
- Off  
Regardless of the Time | Display setting, the sensor buttons and the proximity sensor only respond when the oven is turned on, as well as for a certain amount of time after turning it off.

## Volume

### Buzzer Tones

If audible signals are turned on, an audible signal will sound when the set temperature is reached and at the end of a set time.

The volume of the audible signals is represented by a segment bar.

- ■■■■■■■■  
Maximum volume

- □□□□□□  
Audible signals are switched off

### Keypad Tone

The volume of the tone that sounds each time you tap a sensor button is represented by a segment bar.

- ■■■■■■■■  
Maximum volume

- □□□□□□  
Keypad tone is turned off

### Welcome Melody

The melody that sounds when you tap the  On/Off button can be turned on or off.

## Units of Measurement

### Weight

For automatic programs, you can set the weight of food in grams (g), pounds (lb), or pounds/ounces (lb/oz).

### Temperature

You can set the temperature in Celsius (°C) or Fahrenheit (°F).

## Quick Microwave

For an immediate start of the microwave, a microwave power level of 7 and a cooking duration of 1 minute are preset.

- Power Level  
You can select a microwave power level from 1 through 7.
- Duration  
The maximum cooking duration that can be set depends on the microwave power level selected:  
Power level 1 through 3: maximum 10 minutes  
Power level 4 through 7: maximum 5 minutes

## Popcorn

For an immediate start of the microwave for preparing popcorn, a microwave power level of 6 and a cooking duration of 2:50 minutes are preset. These settings match the manufacturer's instructions on most bags of microwave popcorn.

The maximum cooking duration that can be set is 4 minutes.

The microwave power level is set and cannot be modified.

## Booster

The **Booster** function is used to quickly preheat the oven.

- On  
The **Booster** function is automatically turned on during the preheating phase of a cooking program. The browning/broiling element, ring heating element, and fan all preheat the oven compartment to the required temperature at the same time.

# Settings

## - Off

The **Booster** function is turned off during the preheating phase of a cooking program. Only the heating elements for the selected operating mode are used to preheat the oven compartment.

You can also use the pull-down menu to turn the **Booster** function on or off for a cooking program.

## Recommended temperatures

If you often cook with temperatures that differ from the default, the recommended temperatures can be changed.

After you select this menu option, a list of operating modes will appear on the display.

- Select the operating mode you want to use.

The recommended temperature will appear together with the range within which it can be changed.

- Change the recommended temperature.
- Confirm with *OK*.





Changing the recommended temperature also affects the corresponding operating mode which uses microwave power.

## Recommended power levels

If you often cook with microwave power levels that differ from the default, it makes sense to change the default temperatures.

You can change the default power levels for the **Microwave**  operating mode and for the operating modes which use microwave power.

After selecting this menu option, a list of operating modes will appear in the display together with their default power levels.

- Microwave :  
Power levels 1 through 7
- Combi Auto Roast , Combi Conv Bake/Combi Conv Roast , Combi Broil , and Combi Conv Broil :  
Power levels 1 through 3

- Select the operating mode you want to use.
- Change the default power levels.
- Confirm with *OK*.

## Cooling fan run-on

The cooling fan will continue to run for a while after the oven has been turned off to prevent any humidity building up in the oven, on the control panel, or in the cabinet carcass.

- Temperature controlled  
The cooling fan turns off when the temperature in the oven drops below approx. 160°F (70°C).
- Time controlled  
The cooling fan turns off after a period of about 25 minutes.

Condensation can damage the cabinet carcass and the countertop. This could lead to corrosion of the appliance.

When keeping food warm in the oven, increases to the **Time controlled** setting can lead to condensation in the control panel and moisture on the countertop and cabinet doors.

Do not adjust the **Time controlled** setting and try not to leave food in the warm oven.



## Proximity sensor (MotionReact)

The proximity sensor detects when you approach the touch display, e.g., with your hand or body.

If you want the proximity sensor to respond even when the oven is turned off, select the **Display | QuickTouch | On** setting.

### Switch the light on

- during cooking program  
As soon as you approach the touch display during a cooking process, the oven interior lighting turns on. The oven interior lighting automatically turns off again after 15 seconds.
- always on  
As soon as you approach the touch display, the oven interior lighting turns on. The oven interior lighting automatically turns off again after 15 seconds.
- Off  
The proximity sensor does not respond when you approach the touch display. Press the *Light* sensor button to turn the oven interior lighting on for 15 seconds.

### Switch the appliance on

- On  
If the time is displayed, the oven will turn on and the main menu will appear as you approach the touch display.
- Off  
The proximity sensor does not respond when you approach the touch display. Turn the oven on using the  On/Off button.

## Acknowledge buzzer

- On  
As soon as you approach the touch display, the audible signals turn off.
- Off  
The proximity sensor does not respond when you approach the touch display. Turn the audible signals off manually.

## Safety

### System Lock

The system lock prevents the oven from being turned on inadvertently.

You can still set an alarm and a timer, as well as use the MobileStart function when the system lock is active.

The system lock will remain activated even after a power failure.

- On  
The system lock is now active. If you want to use the oven, touch  for at least 6 seconds.
- Off  
The system lock is now deactivated. You can use the oven as normal.

### Sensor Lock

The sensor lock prevents the cooking program from being turned off by mistake or settings from being changed. Once activated, the sensor lock prevents the sensor buttons and fields on the display from working for a few seconds after a program has been started, with the exception of the  On/Off button.

- On  
The sensor lock is active. Touch *OK* for at least 6 seconds to deactivate the sensor lock for a short period of time.

# Settings

---

- Off  
The sensor lock is not active. All sensor buttons react to touch as normal.

## Furniture front recognition

- On  
Furniture front recognition is activated. Using the proximity sensor, the oven automatically detects whether the cabinet door is closed.  
If the cabinet door is closed, the oven turns off automatically after a certain period.
- Off  
Furniture front recognition is deactivated. The oven does not detect whether the cabinet door is closed.

If the oven is installed behind a cabinet door, the oven, cabinet niche, and the floor can be damaged by the build-up of heat and moisture behind the closed cabinet door.  
Always leave the cabinet door open when you are using the oven.  
Leave the cabinet door open until the oven has cooled down completely.

**Tip:** Turn off furniture front recognition if you want to use the Sabbath Program.

## Miele@home

The oven is a Miele@home-compatible domestic appliance with SuperVision functionality.  
Your oven is equipped ex-works with a WiFi communication module and is suitable for wireless communication.

There are a number of ways of connecting your oven to your WiFi network. We recommend connecting your oven to your WiFi network with the help of the Miele app or via WPS.

- Activate  
This setting is only visible if Miele@home is deactivated. The WiFi function is reactivated.
- Deactivate  
This setting is only visible if Miele@home is activated. Miele@home remains set up; the WiFi function is turned off.
- Connection status  
This setting is only visible if Miele@home is activated. The display shows information such as the WiFi reception quality, network name, and IP address.
- Set up again  
This setting is only visible if a WiFi network has already been set up. Reset the network settings and set up a new network connection straight away.
- Reset  
This setting is only visible if a WiFi network has already been set up. The WiFi function is deactivated and the connection to the WiFi network will be reset to the factory default. You must set up a new connection to the WiFi network to be able to use Miele@home.  
Reset the network settings if you are disposing of or selling your oven, or if you are putting a used oven into operation. This is the only way to ensure that all personal data has been removed and the previous owner will no longer be able to access the oven.

## - Set up

This setting is only visible if no connection to the WiFi network has been set up yet. You must set up a new connection to the WiFi network to be able to use Miele@home.

## Remote Control

If you have installed the Miele app on your mobile device, have access to the Miele@home system, and have activated the remote control function (On), you can use the MobileStart function to retrieve information on oven cooking programs that are in progress or to end a program in progress.

### Activating MobileStart

- Select the *Remote* sensor button to activate MobileStart.

The *Remote* sensor button lights up. You can operate your oven remotely with the Miele app.

Directly operating on the oven takes priority over operating it via the remote control function on the app. You can use MobileStart as long as the *Remote* sensor button is lit up.

## SuperVision

The oven is a Miele@home-compatible appliance with SuperVision functionality for monitoring other domestic appliances in the Miele@home system.

The SuperVision function cannot be activated until the Miele@home system has been set up.

## SuperVision display

- On  
The SuperVision function is turned on. The  symbol will appear in the top right-hand corner of the display.
- Off  
The SuperVision function is turned off.

## Display in standby

The SuperVision function is also available when the oven is in standby. However, the time-of-day display must be turned on (Settings | Time | Display | On).

- On  
Active domestic appliances that are signed on to the Miele@home system are always displayed.
- Only if there is a fault  
Only faults on active domestic appliances are displayed.

# Settings

---

## Appliance list

All domestic appliances signed on to the Miele@home System are displayed. Once you have selected an appliance, you can access further settings:

- Display this Appliance
  - On  
The SuperVision function for this appliance is turned on.
  - Off  
The SuperVision function for this appliance is turned off. The appliance is still signed on to the Miele@home system. Faults are displayed, even if the SuperVision function for the appliance has been turned off.
- Buzzer Tones  
You can select whether the audible signals are turned on (On) or turned off (Off) for this appliance.

## RemoteUpdate

The RemoteUpdate menu option is only displayed and can only be selected if the requirements for using Miele@home have been met (see “Before using for the first time – Miele@home”).

The RemoteUpdate function is used for updating the software in your oven. If an update is available for your oven, it will automatically download it. Updates will not be installed automatically. They must be initiated manually.

If you do not install an update, you can continue to use your oven as usual. However, Miele recommends installing updates.

## Activating/deactivating

The RemoteUpdate function is activated as standard. Available updates will be downloaded automatically but will only be installed if you initiate installation manually.

Deactivate RemoteUpdate if you do not want any updates to be downloaded automatically.

## Running a RemoteUpdate

Information about the content and scope of an update is provided in the Miele app.

A message will appear on your oven display if a software update is available. You can install the update immediately or postpone this until later. When the oven is turned on again, you will be reminded about the update.

Deactivate RemoteUpdate if you do not want to install the update.

The update may take several minutes.

Please note the following information about the RemoteUpdate function:

- You will only receive a message when an update is available.
- Once an update has been installed, it cannot be undone.
- Do not turn the oven off during the update. Otherwise, the update will be aborted and will not be installed.
- Some software updates can only be carried out by Miele Customer Service.

## Electrical version

You can set the voltage variant. The setting must correspond to the voltage of your domestic electrical supply.

## Calibrate temperature

You can change the temperature in increments in all operating modes and automatic programs so that it is higher or lower in the oven compartment than displayed.

The temperature calibration is represented by a bar with seven segments.



If all of the segments are filled, the oven compartment temperature is much higher than displayed. If one segment is filled, the oven compartment temperature is much lower than displayed.

## Software version

The software version menu option is for use by Miele Technical Service. You do not need this information for domestic use.

- Confirm with *OK*.

## Legal information

You can find an overview of the integrated open-source components under Open Source Licenses.

- Confirm with *OK*.

## Showroom Program

This function enables the oven to be demonstrated in dealer showrooms without heating up. Do not activate this setting for domestic use.

## Demo Mode

If you have Demo mode activated, Demo mode is active. The appliance will not heat up will appear when you turn on the oven.

- On  
Touch *OK* for at least 4 seconds to activate Demo mode.
- Off  
Touch *OK* for at least 4 seconds to deactivate Demo mode. You can use the oven as normal.

## Factory default

- Appliance settings  
Any settings that have been altered will be reset to the factory default settings.
- Favorites  
All Favorites will be deleted.
- MyMiele  
All MyMiele entries will be deleted.
- Recommended power levels  
Microwave power levels which have been changed will be reset to the factory default settings.
- Recommended temperatures  
Any recommended temperatures that have been changed will be reset to the factory default settings.

# Alarm + Timer

---

Using the *Timer* sensor button, you can set a timer (e.g., for boiling eggs) or an alarm for a specific time.

Two alarms, two timers, or an alarm and a timer can be set simultaneously.

## Using the Alarm function

The  alarm can be used to specify a particular time for an audible signal to sound.

### Setting the alarm

If the *Display | QuickTouch | Off* setting is selected, you will need to turn the oven on before setting the alarm. The alarm time will then appear on the display when the oven is turned off.

- Select the *Timer* sensor button.
- Select  Alarm.
- Set the time for the alarm.
- Tap *Close* to confirm.

When the oven is turned off, the alarm time and  will appear instead of the time of day.

If you are cooking at the same time or if you are in a different menu, the alarm time and  will appear in the top right-hand corner of the display.

At the specified time for the alarm,  will flash on the display next to the time and an audible signal will sound.

- Select the *Timer* sensor button or the set alarm time on the display.

The audible signal will stop and the symbols on the display will go out.

## Changing an alarm

- Select the alarm on the display or select the *Timer* sensor button and the alarm you want.

The set alarm time will appear on the display.

- Set the new time for the alarm.
- Tap *Close* to confirm.

The adjusted alarm time is now saved and will appear on the display.

## Deleting an alarm

- Select the alarm on the display or select the *Timer* sensor button and the alarm you want.

The set alarm time will appear on the display.

- Select *Delete*.
- Tap *Close* to confirm.

The alarm is deleted.

## Using the Timer function

The  timer can be used to time other activities in the kitchen, e.g., boiling eggs.

The timer can also be used at the same time as a cooking program for which the start and finish times have been set (e.g., as a reminder to stir the food or add seasoning, etc.).

- The maximum timer duration that can be set is 59 minutes and 59 seconds.

## Setting the timer

If you have selected the `Display | QuickTouch | Off` setting, you will need to turn the oven on before setting the timer. The timer can then be seen counting down on the display when the oven is turned off.

Example: you want to boil some eggs and set a timer of 6 minutes and 20 seconds.

- Select the *Timer* sensor button.
- Select  `Timer`.
- Set the required timer duration.
- Tap `Close` to confirm.

When the oven is turned off, the timer duration counts down on the display and  appears instead of the time of day.

If you are cooking at the same time or if you are in a different menu, the timer duration and  will appear in the top right-hand corner of the display.

At the end of the timer duration,  will flash, the time will start counting up, and an audible signal will sound.

- Select the *Timer* sensor button or the required timer on the display.

The audible signal will stop and the symbols on the display will go out.

## Changing the timer

- Select the timer on the display or select the *Timer* sensor button and then the timer duration you want.

The set timer duration will appear.

- Set a new timer duration.
- Tap `Close` to confirm.

The changed timer duration is now saved and will count down in minutes. Timer durations of less than 10 minutes will count down in seconds.

## Deleting the timer

- Select the timer on the display or select the *Timer* sensor button and then the timer duration you want.





















The set timer duration will appear.

- Select `Delete`.
- Tap `Close` to confirm.

The timer is deleted.





## Main and submenus

As different countries have different preferences when it comes to preparing food, the temperatures in °F and °C may not match. The temperatures are defined as they are specified in the table.

Menu	Recommended value	Range
Operating Modes 		
Convection Bake 	350°F (160°C)	85–475°F (30–250°C)
Convection Roast 	375°F (170°C)	85–475°F (30–250°C)
Microwave 	7	1–7
Surround 	400°F (180°C)	85–475°F (30–250°C)
Combination Modes 		
Combi Conv Bake/ Combi Conv Roast 	3 325°F (160°C)	1–3 85–450°F (30–220°C)
Combi Conv Broil 	3 350°F (200°C)	1–3 200–400°F (100–200°C)
Combi Broil 	3  3 	1–3  1–3 
Combi Auto Roast 	3 350°F (160°C)	1–3 200–400°F (100–200°C)
Intensive 	350°F (170°C)	125–450°F (50–220°C)
Auto Roast 	350°F (160°C)	200–450°F (100–230°C)
Bake 	350°F (190°C)	200–400°F (100–200°C)
Maxi Broil 	3	1–3
Convection Broil 	350°F (200°C)	200–475°F (100–220°C)
Automatic Programs 		



## Main and submenus

Menu	Recommended value	Range
Special Modes 		
Popcorn	6	–
Defrost	–	–
Dehydrate	200°F (90°C)	175–225°F (80–100°C)
Reheat	–	–
Warm-up Cookware	175°F (80°C)	125–225°F (50–100°C)
Proof	100°F (35°C)	85–125°F (30–50°C)
Slow Roasting	225°F (100°C)	175–250°F (80–120°C)
Sabbath Program		
Surround	350°F (180°C)	120–475°F (50–250°C)
Bake	350°F (180°C)	120–475°F (50–250°C)
Keep warm	175°F (75°C)	125–200°F (60–90°C)
MyMiele  		
Favorites 		
Settings 		

# Microwave operation

## How it works

The oven contains a magnetron that converts electrical energy into electromagnetic waves (microwaves). These microwaves are distributed evenly throughout the oven compartment and are also reflected by the metal walls inside the oven.

The microwaves penetrate the food from all sides. Food consists of many molecules. When subjected to microwave energy, these molecules (particularly the water molecules) start to oscillate. This heats the food from the outside to the inside. The more water a food contains, the faster it is reheated or cooked.

## Advantages of the microwave oven

- Food can generally be cooked with little or no liquid or cooking oil.
- The times for defrosting, reheating, or cooking are shorter than with a cooktop or oven.
- Vitamins, minerals, natural color, and taste of the food are generally retained.

If the oven is used without food or the food is loaded incorrectly when using the Microwave  operating mode or operating modes that use microwave power, the oven can become damaged.

**Always** use the glass tray with the Microwave  operating mode, even if you use it as a shelf for smaller dishes.

## Suitable dishware

In order for microwaves to reach the food, they must be able to penetrate the dishware being used. Microwaves can pass through porcelain, glass, cardboard, and plastics, but not metal. Therefore, do not use metal containers or dishware that contains metal. Metal reflects the microwaves which can create sparks and the microwaves are not absorbed by the metal.

 Danger of injury from increased pressure in sealed containers or bottles

Pressure can build up when reheating food or drinks in sealed containers or bottles, which can cause them to explode.

Never cook or reheat solid or liquid food in sealed containers or bottles. Open containers beforehand and, with baby bottles, remove the screw top and teat.

 Risk of fire due to using unsuitable dishware for operating modes which use microwave power.

Dishware which is not suitable for use in microwave ovens can be badly damaged and cause damage to the oven.

Only use microwave-safe dishware for operating modes which use microwave power.

The material and shape of dishware used affect reheating and cooking durations.

Heat distribution is more even in round and oval-shaped flat containers. Food is reheated more evenly in these containers than in square ones.

## Suitable dishware

 Fire hazard due to flammable materials.

Disposable containers made out of plastic, paper, or other flammable materials can ignite, causing damage to the oven.

Do not leave the oven unattended when reheating or cooking food in disposable containers made of plastic, paper, or other flammable materials.

You can use the following dishware and materials:

- Heat-resistant glass and ceramic glass  
Exception: crystal glass as it contains lead and may crack.
- Porcelain
  - Without metallic decoration  
Metallic decoration (e.g., gold rims or cobalt blue) can cause sparking.
  - Without hollow knobs and handles  
Moisture can gather in hollow knobs and handles. When the moisture evaporates, pressure can build up and the item can explode.
- Unpainted stoneware and stoneware with underglaze paints

 Danger of injury caused by hot dishware.





Stoneware can get hot.  
Use pot holders when using stoneware.

- Plastic dishware and disposable plastic containers with the Microwave  operating mode

**Tip:** To protect the environment, avoid the use of disposable containers.

Plastic dishware must be heat-resistant to a minimum of 230°F (110°C). Otherwise, the plastic may melt and fuse with the food.

Only use plastic dishware with the Microwave  operating mode.

Do not use plastic dishware with the Combi Auto Roast , Combi Conv Bake/Combi Conv Roast , Combi Broil , or Combi Conv Broil  operating modes.

- Microwave-safe plastic dishware  
Special plastic dishware designed for use in microwave ovens is available from retail outlets.
- Styrofoam dishware  
For briefly heating food.
- Plastic boiling bags  
For cooking and reheating. They should be pierced before use. The holes allow the steam to escape. This prevents a build-up of pressure from forming and the bag from bursting. There are also special bags available for steam cooking which do not need to be pierced. Please follow instructions given on the packet.
- Roasting bags and tubes  
Please follow the manufacturer's instructions.









 Risk of fire due to metal parts.

Metal parts such as metal clips or plastic and paper ties that have wire running through them can heat flammable materials until they burn.

Do not use metal clips or plastic and paper ties containing wire.

## Microwave operation

**Tip:** Metal tins are less suitable for operating modes which use microwave power because the metal reflects the microwaves. The microwaves only reach the cake from above, which extends the baking duration. If you use metal tins, place the tin on the glass tray so that it cannot touch the oven walls. If sparks form, do not reuse the tin for operating modes which use microwave power.

- The **supplied** wire rack is only suitable for cooking processes with the Combi Auto Roast , Combi Conv Bake/Combi Conv Roast , Combi Broil , and Combi Conv Broil  operating modes, as well as for operating modes which do not use microwave power (placed on one level).
- Metal baking tins for baking with the Combi Auto Roast , Combi Conv Bake/Combi Conv Roast , Combi Broil , and Combi Conv Broil  operating modes as well as for operating modes which do not use microwave power
- Aluminum foil trays without lids for defrosting and reheating ready meals  
The food is only heated from the top. If you remove the food from the aluminum foil container and transfer it to dishware suitable for use in a microwave oven, the heat distribution will generally be more even.

Using aluminum foil trays and aluminum foil can cause crackling and sparks.

Therefore, place aluminum foil trays on the glass tray and not on the wire rack.

Aluminum foil and aluminum foil trays must not touch the oven compartment walls and must remain at least 3/4" (2 cm) from the walls at all times.

- Metal skewers or clips  
The size of the cut of meat must be much larger than the metal skewers and clips.

## Unsuitable dishware

Moisture can collect in the hollow spaces on dishware and lids with hollow handles or knobs. When the moisture evaporates, pressure can build up and the item can explode. If the hollow recess is sufficiently ventilated, the item can be used.

Do not use dishware with hollow knobs or handles for cooking.

Do **not** use the following dishware and material:

- Wire racks (including the supplied wire rack) are **not** suitable for use with the Microwave  operating mode.
- Metal containers
- Aluminum foil  
Exception: for even defrosting, reheating, or cooking of unevenly shaped cuts of meat, e.g., poultry, small pieces of aluminum foil may be used to cover thin parts for the last few minutes of the process.
- Metal clips or plastic or paper ties containing wire
- Plastic containers where the aluminum lid has not been completely removed
- Crystal glass
- Utensils and dishware with metallic decoration (e.g., gold rims, cobalt blue)
- Dishware with hollow handles
- Plasticware made of melamine  
Melamine absorbs microwave energy and gets hot.  
When purchasing plasticware, make sure that it is suitable for use in a microwave oven.
- Wooden dishes  
Water contained in wood evaporates during the cooking process. This causes the wood to dry and crack.

## Testing dishware

Unsuitable dishware can cause sparks or crackling noises in microwave operation. If you are not sure whether glass, porcelain, or stoneware dishware is suitable, test the dishes.

This test cannot be used to check whether items with hollow knobs or handles are suitable for use.

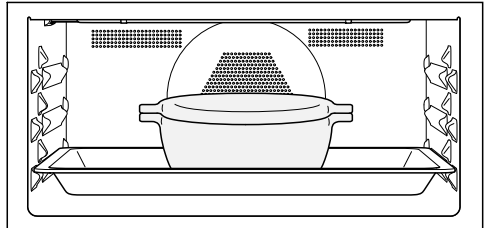

- Place the empty dishware in the middle of the glass tray and insert the tray in shelf level 1.
- Close the door.
- Select the Microwave  operating mode.
- Set the highest microwave power level (level 7) and a cooking duration of 30 seconds.
- Start the process.
- Observe the dishware during the entire duration.
- Immediately open the door if there are sparks or crackling noises.

If there are sparks or if you can hear crackling noises, the tested dishware is not suitable for microwave use.

# Microwave operation

## Cover

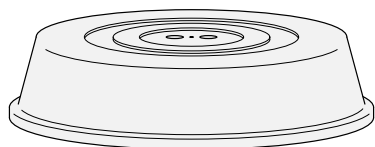



**Tip:** Covers are available from retail outlets.

- A cover prevents too much steam escaping, especially when cooking foods which need longer to cook.
- It speeds up the heating process of the food.
- It prevents food from drying out.
- It helps keep the oven cavity clean.

- Use a glass or plastic cover suitable for microwave use for cooking processes with the Microwave  operating mode.





Alternatively, use a cling film suitable for use in a microwave oven. Heat can cause normal cling film to melt and fuse with the food.

The cover can withstand temperatures of up to 320°F (110°C). At higher temperatures (e.g., in the Maxi Broil  or Combi Conv Bake/Combi Conv Roast  operating modes), the plastic may distort and fuse with the food.

Only use a cover for the Microwave  operating mode.

The cover should not form a seal with the container. If the container has a narrow diameter, the steam may not be able to escape. The cover could get too hot and start to melt.

Use containers with a sufficiently large diameter.

- Do **not** use a cover for heating or reheating the following types of food:
  - food coated in breadcrumbs
  - food which requires a crisp finish, e.g., toast
  - food which is to be heated with the Combi Auto Roast , Combi Conv Bake/Combi Conv Roast , Combi Broil , or Combi Conv Broil  operating modes

If you place food directly on the floor of the oven when using the Microwave  operating mode, the oven can become damaged.

When using the Microwave  operating mode, place the glass tray on level 1 and **always** place containers such as cups and baking tins on the glass tray.

- Turn the oven on.

The main menu will appear.

- Place the food in the oven compartment.
- Select Operating Modes .
- Select the operating mode you want to use.

The operating mode will appear in the display. Depending on the operating mode, the recommended power level, recommended temperature, and the cooking duration will appear in the display.

- Change the recommended values for the cooking process and set the cooking duration if required.

You can change the recommended values later by selecting the relevant value or Timer.

- Touch *OK* to start the cooking process for operating modes which **do not use** microwave power.
- Touch *Start* to start the cooking process for operating modes which **use** microwave power.

The set values appear and the cooking process duration counts down in the display for all operating modes.

If you have set a temperature, you will see the temperature increasing. An audible signal will sound when the set temperature is reached for the first time.

The oven stops generating microwave power when you interrupt the cooking process with *Stop* or open the door. You can continue the cooking process with *Start*.

- After the cooking process, select *Finish* or *Close* (depending on the operating mode).
- Take the food out of the oven compartment.
- Turn the oven off.

## Changing values and settings for a cooking program

Depending on the operating mode, as soon as a cooking program is in progress, you can change the values or settings for this program.

Depending on the operating mode, you can change the following settings:

- Temperature
- Power Level
- Duration
- Ready at
- Start at
- Booster
- Preheat
- Crisp function

# Operation

## Changing the temperature and core temperature

Via Settings | Recommended temperatures, you can permanently adjust the recommended temperature to suit your cooking preferences.

The  core temperature only appears if you are using the probe (see “Roasting – Probe”).

- Tap the temperature display.
- Change the temperature and the  core temperature as required.
- Confirm with *OK*.

The cooking program will resume with the new target temperatures.

## Changing the microwave power level

You can permanently reset the default power level to suit your cooking preferences by selecting Settings | Recommended power levels.

- The set microwave power level will appear in the display.
- Change the microwave power level.
- Select *Start*.

The cooking process continues to run with the modified microwave power level.

## Setting additional durations

Cooking results can be adversely affected if there is a long delay between the food being placed in the oven and the start of cooking. Fresh food can change color and even spoil. When baking, the cake mixture or dough can dry out, and the raising agents can lose their effectiveness. Select as short a time as possible until the start of the cooking process.

You have placed the food in the oven compartment, selected an operating mode and the required settings such as the temperature.

By entering *Duration*, *Ready at* or *Start at*, you can automatically turn the cooking process off or on and off.

- *Duration*  
Enter the required cooking duration for the food. The oven heating will turn off automatically once the cooking duration has elapsed. The maximum cooking duration that can be set depends on the operating mode that you have selected.
- *Ready at*  
Specify when you want the cooking process to finish. The oven will turn off automatically at the time you have set.
- *Start at*  
This function will only appear in the menu if you have set a *Duration* or *Ready at* time. With *Start at*, you have to specify when you want the cooking process to start. The oven will turn on automatically at the time you have set.
- Select  or *Timer*.
- Set the required times.
- Confirm with *OK*.

## Changing set durations

- Select , the duration, or *Timer*.
- Select the time you want and change it.
- Confirm with *OK*.

These settings will be deleted in the event of a power failure.

## Deleting the set cooking durations

- Select , the duration, or *Timer*.
- Select the time you want.



- Select Delete.
- Confirm with *OK*.

If you delete Duration, the set durations for Ready at and Start at are also deleted.

If you delete Ready at or Start at, the cooking program will start using the cooking duration set.

## Interrupting a cooking process in the Microwave operating mode

You can interrupt a cooking process when using the Microwave  operating mode and pause the cooking duration.

While the cooking duration is counting down, Stop appears in the bottom right of the display.

- Select Stop.

The cooking process is interrupted and the cooking duration is paused.

Start is highlighted in green.

- Select Start.

The cooking process resumes and the cooking duration continues to count down.

## Canceling a cooking program

If you cancel a cooking program, the oven heating and lighting will turn off. Any cooking durations set will be deleted.

## Canceling a cooking program without a set cooking duration

- Select Finish.

The main menu will appear.

## Canceling a cooking program with a set cooking duration

- Select Cancel.

Cancel program? will appear.

- Select Yes.

The main menu will appear.

## Preheating the oven



The Booster function is used to quickly preheat the oven cavity in some operating modes.

The Preheat function can be used with any operating mode (except Microwave ) and has to be switched on separately for each cooking process. If you have set a cooking duration, it will only start to count down when the target temperature is reached and you have placed the food in the oven.

The oven cavity only needs to be preheated in a few cases.

- You can place most dishes in the cold oven cavity to make use of the heat produced during the heating-up phase.

- Preheat the oven when cooking the following food with the following operating modes:







- dark bread dough and beef sirloin joints and fillet with the Convection Bake/Convection Roast  and Surround  operating modes
- cakes and pastries with a short cooking duration (approx. 30 minutes or less) as well as delicate items (e.g., sponge) with the Surround  operating mode (without the Booster function)

# Operation

## Booster

The Booster function is used to quickly preheat the oven.

This function is turned on as the factory default setting for the following operating modes (Settings | Booster | On):

- Convection Bake 
- Convection Roast 
- Surround 
- Auto Roast 
- Combi Conv Bake 
- Combi Conv Roast 
- Combi Auto Roast 

If you set a temperature above 210°F (100°C) and the Booster function is turned on, a rapid preheating phase heats the oven compartment to the set temperature. The browning/broiling element and the ring heating element come on together with the fan.

Delicate items (e.g., sponge or cookies) will brown too quickly on the top if the Booster function is used. Turn off the Booster function for these items.

### Turning Booster on or off for a cooking program

If you have selected the Booster | On setting, you can turn the function off separately for a cooking program.

On the other hand, you can also turn on the function separately for a cooking program if you have selected the Booster | Off setting.

Example: You have selected an operating mode and the required settings such as the temperature. You want to turn off the Booster function for this cooking program.

- Drag down the pull-down menu.

Booster is highlighted in orange.

- Select Booster.

Depending on the color scheme, Booster is highlighted in either black or white.

- Close the pull-down menu.

The Booster function is turned off during the preheating phase. Only the heating elements for the selected operating mode are used to preheat the oven compartment.

## Preheat

The oven compartment only needs to be preheated in a few cases.

You can place most dishes in the cold oven compartment to make use of the heat produced during the preheating phase.

If you have set a cooking duration, it will only start to count down when the target temperature is reached and you have placed the food in the oven.

Start the cooking process immediately without delaying the start time.

The Preheat function is not available with the Microwave  operating mode.

### Turning Preheat on

The Preheat function can be used with any operating mode and has to be turned on separately for each cooking program.

Example: You have selected an operating mode and the required settings such as the temperature. You want to turn on the Preheat function for this cooking program.

- Drag down the pull-down menu.

Depending on the color scheme, Preheat is highlighted in either black or white.

- Select Preheat.

Preheat is highlighted in orange.

- Close the pull-down menu.

The following message will be displayed with a time: Place food in oven at . The oven compartment is heated to the set temperature.

- As soon as you are prompted to do so, place the food in the oven.
- Confirm with *OK*.

## Crisp function

It is a good idea to use the Crisp function function (moisture reduction) when cooking food which has a moist topping, e.g., quiche, pizza, tray bakes with fresh fruit toppings, or muffins.

Poultry in particular gets a nice crisp skin with this function.

### Turning Crisp function on

The Crisp function function can be used with any operating mode and has to be turned on separately for each cooking program.

You have selected an operating mode and the required settings such as the temperature.

You want to turn on the Crisp function function for this cooking program.

- Drag down the pull-down menu.

Depending on the color scheme, Crisp function is highlighted in either black or white.

- Select Crisp function.

Crisp function is highlighted in orange.

- Close the pull-down menu.

The Crisp function function is turned on.

## Changing the operating mode

You can change to another operating mode during a cooking program.

- Tap the symbol for the selected operating mode.
- If you have set a cooking duration, confirm the *Cancel program?* message with *Yes*.
- Select the new operating mode.

The new operating mode will appear on the display with its corresponding recommended values.

- Set the values for the cooking program and confirm with *OK*.

## Quick Microwave

---

This function can only be used when no other cooking processes are in use. Always use the glass tray.

### Quick Microwave

If you select the *Minute +* sensor button, the oven starts with a set microwave power level and cooking duration, e.g., to reheat a drink.

The maximum microwave power level of 7 and a cooking duration of 1 minute are preset.

You can change the microwave power level and the cooking duration. The maximum cooking duration that can be set depends on the microwave power level selected (see section “Settings – Quick Microwave”).

- Select the *Minute +* sensor button. Touching the sensor button repeatedly increases the cooking duration in increments.

The time left will appear in the display.

You can interrupt the cooking process at any time with *Stop*, or cancel it by selecting the *Back* sensor button.

At the end of the cooking process, *Ready* appears in the display and an audible signal sounds.

- Select *Close*.

The main menu will appear.

With the wide range of automatic programs, you can achieve excellent results with ease.

## Categories

The automatic programs  are sorted into categories to provide a better overview. Simply select the appropriate automatic program for the type of food you are cooking and follow the instructions on the display.

## Using automatic programs

- Select Automatic Programs .

A list will appear.

- Select the food category you want.

The automatic programs available for the category selected will then appear.

- Select the automatic program that you want to use.
- Follow the instructions on the display.

Some automatic programs will prompt you to use the probe. Read the information under “Roasting – Probe”. Core temperatures cannot be changed for automatic programs.

**Tip:** Use  Info to display information such as how to place or turn the food depending on the cooking program.

## Usage notes

- After cooking, allow the oven compartment to cool down to room temperature again before starting a automatic program.
- Some automatic programs require a preheating phase before food can be placed in the oven. A prompt will appear on the display indicating when this needs to be done.
- Some automatic programs require liquid to be added during the cooking process. You will be prompted by a message on the display when this needs to be done (e.g., for adding liquid).
- The duration quoted for automatic programs is an estimate. It may increase or decrease depending on the program. The duration, in particular with meat, will vary depending on the initial temperature of the food.
- When you use the probe, the cooking duration will depend on when the core temperature is reached.
- If by the end of a automatic program the food is not cooked enough for your taste, select *Continue cooking* or *Continue baking*. Conventional heating will then be used for 3 minutes to continue cooking or baking the food.

# Automatic Programs

---

## Search

(Depending on language)

Under Automatic Programs, you can search by the name of the categories and the automatic programs.

This search is a full-text search and can also be used to search for parts of words.

From the main menu:

- Select Automatic Programs .

The category list will appear on the display.

- Select Search.
- Use the keyboard to type in the search text, e.g., "Bread".

The number of hits will be shown in the footer.

If no match is found or if there are more than 40 matches, the hits field will be deactivated and you will need to change the search text.

- Select XX hits.

The categories and automatic programs found will then appear.

- Select the automatic program you want, or the category and then the automatic program you want.

The automatic program will start.

- Follow the instructions on the display.

This section provides information on the following applications:

- Popcorn
- Defrost
- Dehydrate
- Reheat
- Warm-up Cookware
- Proof
- Slow Roasting
- Sabbath Program
- Keep warm
- Cooking
- Canning
- Frozen food/ready meals

### Popcorn

If you select the Popcorn program, the oven starts with a set microwave power level and cooking duration.

Microwave power level 6 and a cooking duration of 2:50 minutes are preset. These settings match the manufacturer's instructions on most bags of microwave popcorn.

The maximum cooking duration that can be set is 4 minutes. The microwave power level is set and cannot be modified (see section "Settings – Popcorn").

■ Select Special Modes .

■ Select Popcorn.

The time left will appear in the display.

You can interrupt the cooking process at any time with *Stop*, or cancel it by selecting the *Back* sensor button.

Disposable containers made out of paper or other flammable materials can ignite, causing damage to the oven.

Do not leave the oven unattended during the cooking process and make sure you follow the instructions on the packaging.

At the end of the cooking process, *Ready* appears in the display and an audible signal sounds.

■ Select *Close*.

The main menu will appear.



# Special Modes

---

## Defrost

Gentle defrosting of frozen food means that the vitamins and minerals are generally retained.

■ Use one of the following operating modes and Special Modes:

- Special Modes  | Defrost  
Select a category and the weight for the food.
- Operating Modes  | Microwave   
Set the microwave power level and the defrosting duration.

Always observe USDA/CFIA food safety guidelines.

 Risk of infection from bacteria. Bacteria such as salmonella can cause life-threatening food poisoning. It is particularly important to observe food hygiene rules when defrosting fish and meat, and in particular when defrosting poultry. Do not use the liquid produced during defrosting. Process the food as required as soon as it has been defrosted.

## Tips

- Place the food to be defrosted on the glass tray without its packaging.
- For defrosting poultry, use the glass tray with the wire rack placed on top of it. This way the frozen food will not be lying in the defrosted liquid.
- Meat, poultry, or fish does not need to be fully defrosted before cooking. Defrost until the food has started to thaw. The surface will then be sufficiently thawed to take herbs and seasoning.



## Using the Defrost Special Mode

Use the “Defrost” mode to gently defrost frozen food.

Only use dishware that is microwave safe.

- Select Special Modes .
- Select Defrost.

A list will appear.

- Select the desired food category.
- Enter the weight of the frozen food.

You can start the defrosting process immediately or delay the start and display the individual actions and cooking stages.

- Follow the instructions on the display.

### Tips

- Use **i** Info to display information such as when to turn the frozen food, depending on the cooking process.
- If the frozen food is not defrosted properly by the end of the defrosting process, select **Cont. Keep warm**. The frozen food will continue to be heated for 3 minutes.
- After the defrosting process has ended, select **Save** to save the settings for the selected category and weight as a Favorite (see “Favorites”).

## Using the Microwave operating mode

Instead of the Special Mode, you can use the Microwave  operating mode for defrosting. Set the microwave power level and the defrosting duration.



The time required depends on the nature of the food, its initial temperature, and the amount to be cooked. Take note of the standing times.

Only use dishware that is microwave safe.

- Select Operating Modes .
- Select Microwave .
- Depending on the type of food, set the microwave power level and the defrosting duration specified in the chart.
- In general you are advised to select the middle duration.
- Place the food on the glass tray on shelf level 1 in the oven cavity.

## Special Modes

### Defrosting with the Microwave operating mode

Food to be defrosted	Quantity		 [min]	 [min] <sup>1</sup>
Butter	1/2 lb (250 g)	1	8–10	5–10
Milk	4 1/4 c (1000 ml)	4	12–16	10–15
Sponge cake (3 slices)	Approx. 0.6 lb (300 g)	2	4–6	5–10
Fruit cake (3 slices)	Approx. 0.6 lb (300 g)	2	6–8	10–15
Butter cake (3 slices)	Approx. 0.6 lb (300 g)	2	6–8	5–10
Cream cake (3 slices)	Approx. 0.6 lb (300 g)	1	4–4:30	5–10
Yeast rolls, puff pastries (3 pieces)	Approx. 0.6 lb (300 g)	2	6–8	5–10

 Microwave power level,  defrosting time,  standing time

<sup>1</sup> Allow food to stand at room temperature. This standing time allows the heat to spread evenly throughout the food.





## Dehydrate





Dehydrating or drying is a traditional method of preserving fruit, certain vegetables, and herbs.

It is important to check that fruit and vegetables are fresh, ripe and unbruised before they are dehydrated.

- Prepare the food for drying by cutting it up, and peeling and coring it if necessary.
- Depending on how big it is, distribute the food for drying as evenly as possible over the rack or glass tray in a single layer.
- Dry on a maximum of 2 levels at the same time.  
Place the food for drying on shelf levels 1+2.  
If you are using both the rack and glass tray, insert the glass tray below the rack.
- Select Special Modes .
- Select Dehydrate.
- Alter the recommended temperature if necessary and then set the time.
- Follow the instructions on the display.
- Turn the food being dried on the glass tray at regular intervals.

The drying times are longer for whole or halved food.

Food for drying		°F [°C]	⌚ [h]
Fruit		140-160 (60-70)	2-8
Vegetables		130-150 (55-65)	4-12
Mushrooms		115-125 (45-50)	5-10
Herbs*		85-95 (30-35)	4-8

-  special mode/operating mode,
-  temperature,  drying time,
-  special mode Dehydrate,
-  operating mode Surround

\*When drying herbs, always use the glass tray on shelf level 2 and use the Surround  operating mode, as the fan is switched on in the Dehydrate special mode.

- Reduce the temperature if condensation begins to form in the oven.

## Removing the dried food

 Risk of injury caused by hot surfaces.

The oven gets hot during operation. You could burn yourself on the heating elements, oven compartment, or accessories. Use pot holders when removing the food from the oven.

- Allow the fruit or vegetables to cool down after dehydrating.

Dried fruit must be completely dry, but also soft and elastic. Juice should not escape when cut.

- Store dried food in sealed glass jars or cans.

# Special Modes

## Reheat

It is essential that the information in “IMPORTANT SAFETY INSTRUCTIONS – Correct use” is observed.

 Danger of injury caused by hot food.

If food for babies and children is heated at too high a temperature, they can burn themselves.

Only heat food for babies and children for 30–60 seconds at microwave power level 4.

After heating food, especially food for babies and small children, stir the food or shake the container and taste the food so that children do not get burned.

 Danger of injury from increased pressure in sealed containers or bottles.

Pressure can build up during reheating in sealed containers or bottles, causing them to explode.

Never cook or reheat food or liquids in sealed containers or bottles. Open containers beforehand and with baby bottles, the screw top and teat must be removed.

Danger of injury caused by hot liquids.

When heating food, and in particular liquids, using the

Microwave  operating mode, the boiling point may be reached without the typical bubbles being produced. The liquid does not boil evenly throughout.

This boiling delay can result in the liquid boiling over explosively. Take care when taking the container out of the oven, as the hot liquid can cause severe scalding. Under certain circumstances, the pressure can be so high that the door opens automatically.

Stir liquids well before heating or cooking.

After heating, wait at least 20 seconds before removing the container from the oven.

In addition, you can place a glass rod or similar item, if available, in the container during the heating process.

## Using the Reheat Special Mode

This program is designed for reheating food.

The time required depends on the nature of the food, its initial temperature, and the amount to be cooked. For example, food taken straight from the refrigerator takes longer to reheat than food which has been kept at room temperature. Take note of the standing times.

Only use dishware that is microwave safe.

Always cover food when reheating it, except when reheating meat/fish coated in breadcrumbs.

- Place the food that is to be reheated on the glass tray with a cover.
  - Select Special Modes .
  - Select Reheat.
- A list will appear.
- Select the desired food category.
  - Enter the weight of the food.
  - Follow the instructions on the display.

 Danger of burning due to hot surfaces.

The oven gets hot during operation. You could burn yourself on the heater elements, oven cavity, or accessories. Condensation may accumulate on the bottom of the dishware.

Use pot holders when working in the hot oven cavity and when removing the dishware.

During the standing time, the temperature is distributed evenly in the food.



- After reheating, allow the food to stand at room temperature for a few minutes to enable the heat to spread evenly throughout the food.

## Tips

- Always cover food when reheating it, except when reheating meat/fish coated in breadcrumbs.
- Use  Info to display information such as when to turn or stir the food, depending on the cooking process. Stir the food from the outside towards the middle, as food heats more quickly from the outside.
- If the food is not hot enough at the end of the program, select Cont. Keep warm. The food will continue to be heated for 3 minutes.
- After the program has finished, select Save to save the settings for the selected category and weight as a Favorite (see “Favorites”).

## Special Modes

### Reheating with the Microwave operating mode

Drink/ Food	Quantity		 [min]	 <sup>1</sup> [min]
Drinks (drinking temperature 140-150°F (60-65°C))	1 cup/1 glass (8 oz/200 ml)	7	00:50-1:10	—
Baby bottle (milk) <sup>2</sup>	Approx. 8 oz (200 ml)	4	00:50-1:00 <sup>3</sup>	1
Food for babies and children <sup>3</sup>	1 jar (8 oz/200 g)	4	00:30-1:00	1
Sliced meat with sauce <sup>3</sup>	8 oz (200 g)	5	3:00-5:00	1
Side dishes <sup>3</sup>	1/2 lb (250 g)	5	3:00-5:00	1

 Microwave power level,  cooking duration,  standing time

- <sup>1</sup> Allow food to stand at room temperature. This standing time allows the heat to spread evenly throughout the food.
- <sup>2</sup> A boiling delay can be avoided by stirring liquids before reheating them. After heating, wait at least 20 seconds before removing the container from the oven. In addition, you can place a glass rod or similar item, if available, in the container during the heating process.
- <sup>3</sup> The durations apply to food with an initial temperature of approx. 40°F (5°C). For food not normally refrigerated, durations apply to food at room temperature of approx. 105°F (20°C).  
With the exception of baby food and delicate whisked sauces, food should be heated to a temperature of 155-165°F (70-75°C).

## Warm-up Cookware

Preheating the dishware means that food does not cool down as quickly.

Use heat-resistant dishware.

- Place the wire rack on shelf level 1 and place the dishware to be heated on it. Depending on the size of the dishware, you can also place it on the oven floor.
- Select Special Modes .
- Select Warm-up Cookware.
- Alter the recommended temperature if necessary and then set the time.
- Follow the instructions on the display.



**Danger of injury caused by hot surfaces.**

The oven gets hot during operation. You could burn yourself on the heater elements, oven cavity, or accessories. Condensation may accumulate on the bottom of the dishware. Use pot holders when removing dishware.

## Proof

This program is designed specifically for proofing dough.

- Select Special Modes .
- Select Proof.
- If necessary, adjust the recommended temperature and set the cooking duration.
- Follow the instructions on the display.

## Keep warm

You can keep food warm in the oven for several hours.

In order to maintain the quality of food, select the shortest possible time.

- Select Special Modes .
- Select Keep warm.
- Place the food to be kept warm in the oven and confirm with *OK*.
- Alter the recommended temperature if necessary and then set the time.
- Follow the instructions on the display.

# Special Modes

---

## Slow Roasting

The Slow Roasting method is ideal for cooking beef, pork, veal, or lamb when you want a tender result.

Always observe USDA/CFIA food safety guidelines.

First briefly sear the meat on all sides at a high temperature on the cooktop in order to seal it.

Then place the meat in the preheated oven compartment where the low temperature and long cooking duration will cook it to perfection and ensure it is very tender.

The meat will relax. The juices inside will start to circulate evenly throughout the meat to reach the outer layers.

This gives very tender and succulent results.

- Only use lean meat which has been correctly seasoned and trimmed. Bones should be removed before cooking.
- For searing, use a suitable cooking oil or fat that can withstand high temperatures (e.g., clarified butter, vegetable oil).
- Do not cover meat during the cooking process.

The cooking duration takes approx. 2–4 hours depending on the weight and size of the meat and how well you want it cooked.

- As soon as the cooking process has finished, you can carve the meat straight from the oven. It does not need to rest.
- You can leave the meat in the oven to keep warm until you serve it. This will not affect results in any way.

- Serve on preheated plates with very hot sauce or gravy to prevent it cooling down too quickly. The meat is at an ideal temperature to eat straight away.



## Using the Slow Roasting Special Mode

Observe the information under “Roasting – Precision Probe”.

- Select Special Modes .
- Select Slow Roasting.
- Follow the instructions on the display. Place the necessary accessories in the oven compartment for the preheating phase.
- Set the temperature and the core temperature.
- While the oven is preheating, sear the meat on all sides on the cooktop.

 Danger of burning due to hot surfaces.

The oven gets hot during operation. You could burn yourself on the heating elements, oven compartment, or accessories.



When the oven is hot, use pot holders to insert, remove, or turn food, as well as when adjusting the oven shelves, etc.

- **Once** Insert the probe and place food in the oven appears on the display, place the seared meat on the wire rack and insert the probe so that the metal tip is fully in the center of the meat.
- Close the door.

At the end of the program, Ready will appear on the display and an audible signal will sound.

## Using the Surround operating mode

Use the glass tray with the wire rack placed on top of it.  
Turn off the Booster function for the preheating phase.

- Place the glass tray with a wire rack on shelf level 1.
- Select Operating Modes .
- Select the Surround  operating mode and a temperature of 210°F (100°C).
- Turn off the Booster function via the pull-down menu.
- Preheat the oven with the glass tray and the wire rack inside for approx. 15 minutes.
- While the oven is preheating, sear the meat on all sides on the cooktop.

 Danger of burning due to hot surfaces.

The oven gets hot during operation. You could burn yourself on the heater elements, oven cavity, or accessories. Use pot holders when placing food in the appliance or removing it and when working in the hot oven cavity.

- Place the seared meat on the wire rack.
- Reduce the temperature to 195°F (90°C).
- Continue cooking the meat until it is done.

## Special Modes

### Cooking durations/core temperatures

Always observe USDA/CFIA food safety guidelines.

Meat	Cooking duration	Core temperature
Beef tenderloin, approx. 2.2 lbs (1 kg) - rare - medium - well done	60–80 min 75–85 min 110–130 min	113–119°F (45–48°C) 129–135°F (54–57°C) 145–151°F (63–66°C)
Prime rib, approx. 2.2 lbs (1 kg) - rare - medium - well done	70–80 min 105–115 min 130–140 min	113–119°F (45–48°C) 129–135°F (54–57°C) 145–151°F (63–66°C)
Pork tenderloin, approx. 0.75 lbs (350 g)	70–90 min	145–156°F (63–69°C)
Gammon joint*, approx. 2.2 lbs (1 kg)	140–160 min	145–151°F (63–66°C)
Veal tenderloin, approx. 2.2 lbs (1 kg) - pink - medium - well done	45–55 min 75–85 min 90–100 min	113–119°F (45–48°C) 129–135°F (54–57°C) 145–151°F (63–66°C)
Saddle of veal*, approx. 2.2 lbs (1 kg) - pink - medium - well done	75–85 min 100–130 min 130–140 min	113–119°F (45–48°C) 129–135°F (54–57°C) 145–151°F (63–66°C)
Saddle of lamb*	40–60 min	129–151°F (54–66°C)

\* Boneless

## Sabbath Program

The Sabbath Program and Yom-Tov Special Modes help to support religious observance.

The oven heats up to the temperature you have set and maintains this temperature for a maximum of 24 hours (Sabbath Program) or 76 hours (Yom-Tov).

- Turn off Cabinet door front recognition.
- Select Special Modes .
- Select Sabbath Program.
- Select the Special Mode you want.
- Select the operating mode you want to use.

You will not be able to start the Special Mode if you have set a timer or alarm.

- Set the temperature.
- Select Start.

The name of the Special Mode and the set temperature will appear on the display.

The oven heating will turn on around 30 seconds after you have closed the door.

The oven interior lighting will remain on during the entire cooking period.

Sabbath Program or Yom-Tov and the set temperature will appear permanently on the display.

The time of day will not appear. The proximity sensor will not respond, and neither will any of the sensor buttons (except for the  On/Off button).

The message Do not open the door will appear.

After around 1 hour, this information will turn off from time to time. You can open the door when this message is **not** shown.

- Place the food in the oven.

The Sabbath Program Special Mode ends after 24 hours. The display will not change.

In both Special Modes, the oven turns off automatically after 76 hours.

- If you want to end the Special Mode prematurely, turn off the oven using the  On/Off button.

Once a Special Mode has started, it cannot be changed or saved under Favorites.

## Special Modes

---

### Cooking

It is essential that the information in “IMPORTANT SAFETY INSTRUCTIONS – Correct use” is observed.

Food with a thick skin or peel, such as tomatoes, sausages, potatoes, and eggplant can burst when heated or cooked.

Pierce or score the skin of these foods several times to allow steam to escape.

Eggs heated in their shell can burst, even after they have been removed from the oven.



Eggs can only be cooked in their shells in a specially designed egg-boiling device. Do not reheat hard-boiled eggs using the Microwave  operating mode.

If possible, use the probe to monitor the temperature when cooking (see “Roasting – Probe”).





Set the core temperature:

- fish: at least 158°F (70°C)
- poultry: at least 185°F (85°C)

### Tips

- Turn, separate, or stir the food several times. Stir the food from the outside towards the middle, as food heats more quickly from the outside.
- Use only dishware that is suitable for use in a microwave and oven when using operating modes which use microwave power.
- If possible, use MasterChef for cooking.
- Never use a lid with the Combi Conv Broil  and Combi Broil  operating modes, as the food will not brown.
- Select microwave power level 6 in the Microwave  operating mode to start cooking and then continue cooking at power level 4.

## Cooking with the Microwave operating mode

Soups/stews Vegetables	 [g]	Level 6  [min]	+	Level 4  [min]	 <sup>1</sup> [min]
Stew	1500	10	+	20	1
Soup	1500	11	+	24	1
Peas	500	5	+	10	2
Peas (frozen)	450	5	+	12	2
Carrots	500	5	+	10	2
Broccoli florets	500	6	+	8	2
Broccoli (frozen)	450	5	+	11	2
Cauliflower florets	500	6	+	10	2
Kohlrabi batons	500	3	+	8	2
Asparagus	500	5	+	8	2
Leeks	500	5	+	8	2
Leeks (frozen)	450	5	+	8	2
Peppers, cut into strips	500	5	+	10	2
Beans, green	500	4	+	12	2
Brussels sprouts	500	5	+	12	2
Brussels sprouts (frozen)	450	5	+	10	2
Mixed vegetables (frozen)	450	5	+	12	2

 Weight,  cooking duration,  standing time

<sup>1</sup> Allow food to stand at room temperature. This standing time allows the heat to spread evenly throughout the food.

## Special Modes

### Canning

 Risk of infection from bacteria. The spores of the botulinum bacterium are not sufficiently killed by canning legumes and meat only once. Toxins may form which can lead to serious poisoning. These spores are only destroyed by canning the food again. After they have cooled down, **always** reheat legumes and meat a second time within 2 days.



 Risk of injury from increased pressure in sealed cans. Canning food and heating it up in closed containers results in an increase in pressure which can cause them to explode. Do not use cans for canning or reheating food.

Always observe USDA/CFIA food safety guidelines.

### Preparing fruit and vegetables

The instructions are for a maximum of 5 jars with a capacity of 0.5 L each.

Only use jars that are specifically designed for canning:

- Convection Bake : bottling jars with a screw cap
- Microwave : microwave-safe bottling jars with glass lids, sealed with clear adhesive tape

- Only use undamaged jars and rubber rings.
- Rinse the jars with hot water before canning and fill them up to a maximum of 3/4" (2 cm) below the rim.
- After filling the jars, clean the outside of the rims with a clean cloth and hot water.
- Seal the jars with clear adhesive tape. Do not use any metal clips as they cause sparks when used with the Microwave  operating mode.
- Insert the glass tray on shelf level 1 and place the jars on it.

### Using the Convection Bake operating mode

- Select the Convection Bake  operating mode and a temperature of 320-340°F (160–170°C).
- Wait until bubbles rise evenly in the jars.



Then reduce the temperature to prevent the contents from boiling over.

## Canning fruit and vegetables

- Set the specified post-canning warming temperature as soon as bubbles are visible in the jars, then leave the jars in the warm oven for the time specified.

## Canning vegetables

- As soon as bubbles are visible in the jars, set the specified canning temperature and cook the vegetables for the time specified.
- After canning, set the specified post-canning warming temperature, then leave the jars in the warm oven for the time specified.

		
Fruit	-/-	85°F (30°C) 25–35 min
Pickling cucumbers	-/-	85°F (30°C) 25–30 min
Red beets	250°F (120°C) 30–40 min	85°F (30°C) 25–30 min
Beans (green or yellow)	250°F (120°C) 90–120 min	85°F (30°C) 25–30 min

 Canning temperature and time once bubbles are visible in the jars

 Post-canning warming temperature and time

## Using the

## Microwave operating mode

- Select the Microwave  operating mode and microwave power level 6.
- Wait until bubbles rise evenly in the jars. This takes about 3 minutes per jar. With 5 jars, therefore, it takes 15 minutes.



Then reduce the microwave power level to prevent the contents from boiling over.

## Canning fruit and vegetables

- Switch the oven off as soon as bubbles are visible in the jars. Then leave the jars in the warm oven cavity for the time specified.

## Canning vegetables

- As soon as bubbles are visible in the jars, set the specified microwave power level and cook the vegetables for the time specified.
- Switch the oven off after bottling and then leave the jars in the warm oven cavity for the time specified.

		
Fruit	-/-	25–35 min
Pickling cucumbers	-/-	25–30 min
Beets	Level 4 20–30 min	25–30 min
Beans (green or yellow)	Level 4 20–30 min	25–30 min

 Microwave power level and bottling time, as soon as bubbles are visible

 Continued warming time

# Special Modes

---

## Removing the jars after canning



Risk of injury caused by hot surfaces.

The jars will be very hot after canning. Use oven mitts when removing the jars from the oven.

- Take the jars out of the oven.
- Cover the jars with a towel and leave to set for approx. 24 hours in a draft-free area.
- After they have cooled down, **always** reheat beans and meat a second time within 2 days.
- Remove the fasteners from the jars and make sure all jars are closed properly when storing them.

Either boil open jars again or store them in a cool place and consume the preserved fruit or vegetables immediately.

- Check the jars during storage. If jars have opened during storage or if the screw cap is bulging and does not make a popping noise when opened, dispose of the contents.

## Frozen food/ready meals

### Tips for cakes, pizza, and baguettes

- Bake cakes, pizza, and baguettes on parchment paper on the wire rack.
- Use the lowest temperature recommended by the manufacturer.

### Tips for French fries, croquettes, and similar items

- Bake these frozen products on parchment paper on the glass tray.
- Use the lowest temperature recommended by the manufacturer.
- Turn several times during cooking.

### Preparing frozen food/ready meals

Handling and cooking food correctly is essential for maintaining good health.

Cakes, pizzas, and French fries should be cooked until golden, not dark brown.

- Select the operating mode and temperatures recommended on the food's packaging.
- Preheat the oven.
- Place the food in the preheated oven on the shelf level recommended on the packaging.
- Check the food at the end of the shortest time recommended on the packaging.





Under MyMiele  , you can save frequently used applications.

It is particularly useful with the automatic programs as you do not need to work through every menu level in order to start a program.



**Tip:** You can also set menu options that you have entered in MyMiele to appear on the start screen (see “Settings – Start screen”).

## Adding entries

You can add up to 20 entries.

- Select MyMiele  .
- Select Add entry.

You can select options from the following categories:



- Operating modes
- Automatic Programs  **Auto**
- Special Modes  
- Favorites  

- Confirm with *OK*.

The selected subitem and its respective symbol will appear in the list.



- Proceed as described for more entries. Only options that have not yet been selected are available for selection.

## Deleting entries

- Select MyMiele  .
- Touch the entry you want to delete and keep your finger on it until the context menu appears.
- Select Delete.

The entry will then be removed from the list.

## Moving entries

- Select MyMiele  .
- Touch the entry you want to move and keep your finger on it until the context menu appears.
- Select Move.

An orange border will appear around the entry.

- Move the entry.

The entry will now appear in the position you want it in.

## Favorites

---

You can create and save up to 20 of your own programs.

- You can combine up to 10 cooking stages to accurately program your favorite or most frequently used recipes. In each cooking stage, you can select settings such as the operating mode, temperature, and cooking duration or core temperature.
- You can specify the shelf level(s) for the food.
- You can enter a program name for your recipe.

When you next select the program, it will start automatically.

There are different ways of creating a Favorite:

- When an automatic program finishes running, save it as a separate program.
- After running a program with a set duration, save it.

Then name the program.

### Creating a Favorite

- Select Favorites .
- Select Create program.

You can now specify the settings for the first cooking stage.

Follow the instructions on the display:

- Select and confirm the settings.

If you select the Preheat function, use **Add** to add another cooking stage where you set a cooking duration. Only then can you save or start the program.

All settings for the first cooking stage have now been set.

More cooking stages can be added, for example, if you would like to add another operating mode to follow the first.

- If additional cooking stages are required, select **Add** and proceed as for the first cooking stage.
- When you have finished setting the cooking stages, select **Set shelf level**.
- Select the level(s) you want.
- Confirm with **OK**.

If you want to check the settings or to change them at a later stage, tap the cooking stage in question.

- Select **Save**.
- Enter the program name using the keyboard.

You can add a line break for longer program names using the **↵** symbol.

- Once you have entered the program name, select **Save**.

A message will appear on the display confirming that the name has been saved.

- Confirm with **OK**.

You can start the saved program immediately, delay the start, or change the cooking stages.

## Starting Favorites

- Place the food in the oven cavity.
- Select Favorites .
- Select the program you want to use.

Depending on the program settings, the following menu options will appear on the display:

- Start now  
The program will start immediately. The oven heating will turn on immediately.
  - Ready at  
You can set the time at which the cooking program should end. The oven will turn off automatically at the time you have set.
  - Start at  
You can set the time at which the cooking program should start. The oven will turn on automatically at the time you have set.
  - Display cooking stages  
A summary of your settings will appear on the display.
  - Display actions  
The required actions, e.g., placing the food in the oven, will appear on the display.
- Select the menu option you want.
  - Confirm the message regarding which shelf level to use with *OK*.

The selected program will begin automatically right away or at the time set.

Use  Info to display information such as how to place or turn the food depending on the cooking process.

- At the end of the program, select Close.

## Changing cooking stages

Cooking stages in an automatic program that have been saved under a different name cannot be changed.

- Select Favorites .
- Touch the program you want to change and keep your finger on it until the context menu appears.
- Select Change.
- Select the cooking stage that you want to change or *Add* to add another cooking stage.
- Select and confirm the settings.
- If you want to start the modified program without changing it, select *Start*.
- Select *Save* when you have changed all the settings.

A message will appear on the display confirming that the name has been saved.

- Confirm with *OK*.

The saved program has been changed and you can start it immediately or delay the start.

# Favorites

---

## Renaming Favorites

- Select Favorites .
- Touch the program you want to change and keep your finger on it until the context menu appears.
- Select Rename.
- Change the program name using the keyboard.

You can add a line break for longer program names using the  symbol.

- Once you have changed the program name, select Save.

A message will appear on the display confirming that the name has been saved.

- Confirm with *OK*.

The program has now been renamed.

## Deleting a Favorite

- Select Favorites .
- Touch the program you want to delete and keep your finger on it until the context menu appears.
- Select Delete.
- Confirm the query with *Yes*.

The program is deleted.

Go to Settings | Factory default | Favorites to delete all Favorites at the same time.

## Moving Favorites

- Select Favorites .
- Touch the program you want to move and keep your finger on it until the context menu appears.
- Select Move.

An orange border will appear around the entry.

- Move the program.

The program will now appear in the position you want it in.

Handling and cooking food correctly is essential for maintaining good health.

Cakes, pizzas, and French fries should be cooked until golden, not dark brown.

Always observe USDA/CFIA food safety guidelines.

## Tips for baking

- Set a cooking duration. If used for baking, do not delay the start for too long. Otherwise the cake mixture or dough will dry out, and the raising agents will lose their effectiveness.
- Avoid using bright, thin-walled pans made from a shiny material as they give an uneven or poor browning result. In certain unfavorable conditions, the food will not cook properly.
- Place cakes in rectangular bakeware on the wire rack with the longer side across the width of the oven for optimum heat distribution and even results.
- Line the glass tray with parchment paper before placing chips, croquettes, and similar types of food on it.

## Selecting the temperature

- Select the suggested temperature in general.

Choosing a baking temperature higher than those recommended may reduce the cooking time, but will lead to uneven browning and unsatisfactory cooking results.

## Selecting the cooking duration

- Check whether the food is cooked shortly before the end of the specified cooking duration. Stick a wooden skewer into the food.

If it comes out clean without any batter/dough on it, the food is done.

## Notes on the operating modes

You can find an overview of all the operating modes with their recommended values in “Main and submenus”.

### Using Automatic Programs

- Follow the instructions on the display.

### Using Convection Bake

You can use any type of bakeware made of heat-resistant material.

Because the blower distributes the heat around the oven cavity straight away, you can use a lower temperature than you would with the Surround  operating mode.

Use this operating mode if you are baking on multiple shelf levels at the same time.

- 1 shelf level: place cakes in baking tins on shelf level 1.
- 1 shelf level: place flat items (e.g., cookies, tray cakes) on shelf level 2.
- 2 shelf levels: depending on the height, place the food on shelf levels 1+3 or 2+3.

### Using Surround

Dark metal, enamel, or aluminum bakeware with a matte finish, as well as heat-resistant glass, ceramic, and coated bakeware can be used.

# Baking

---

Use this operating mode for cooking traditional recipes. If using an older recipe or cookbook, set the oven temperature 20°F (10°C) lower than that recommended. This will not change the cooking duration.

- Place cakes in baking tins on shelf level 1.
- Place flat items (e.g., cookies, tray cakes) on shelf level 2.

## Using Intensive

You can use any type of bakeware made of heat-resistant material.

Use this operating mode for baking cakes with moist toppings.

Do **not** use this operating mode for baking thin cookies.

- Place cakes in baking tins on shelf level 1.

## Using Combi Conv Bake

Use heat-resistant baking tins suitable for microwave use (see “Microwave operation – Suitable dishware”), such as heat-resistant glass or ceramic dishes, as these allow microwaves through them.

The Combi Conv Bake  operating mode is particularly suitable for baking dough which requires a longer cooking duration, such as rubbed in, beaten mixtures and yeast recipes.

If you use this operating mode, the cooking duration is shortened.

- Place the glass tray on shelf level 1.
- Place the baking tin on the glass tray.

**Tip:** Metal tins are less suitable for operating modes which use microwave power because the metal reflects the microwaves. The microwaves only reach the cake from above, which extends the cooking duration. If you use metal tins, place the tin on the glass tray so that it cannot touch the oven walls. If sparks form, do not reuse the tin for operating modes which use microwave power.

Always observe USDA/CFIA food safety guidelines.

## Tips for roasting

- **Preheating** the oven is only required when roasting beef sirloin and fillet. Preheating is generally not necessary.
- Use a **closed cooking container** for roasting meat, such as a roasting dish. The meat will stay succulent. The oven cavity will also stay cleaner than when roasting on the wire rack. It ensures that enough stock remains for making gravy.
- If you are using a **roasting bag**, follow the instructions on the packaging.
- If you are using the **wire rack** or an **open cooking container** for roasting, you can add a little fat or oil to very lean meat or place a few strips of streaky bacon on the top.
- **Season** the meat and place in the cooking container. Dot with butter or brush with oil or cooking fat. For large lean cuts of meat (4.5–6.5 lbs/2–3 kg) and fatty poultry, add about 1/2 cup (1/8 liter) of water to the dish.
- Do not add too much liquid during cooking as this will hinder the **browning** process. Browning only occurs towards the end of the cooking duration. Remove the lid about halfway through the cooking duration if you want a more intensive browning result.
- At the end of the program, take the food out of the oven, cover it, and leave to **stand** for about 10 minutes. This helps retain the juices when the meat is sliced.

- For a crisp finish, baste **poultry** 10 minutes before the end of the cooking duration with slightly salted water.

## Selecting the temperature

- As a general rule, select the temperature given in the corresponding recipe.
- For large pieces of meat, do not choose a temperature that is too high. The roasting process will take longer, but the meat will cook through evenly and the skin or crackling will not be too thick.

## Selecting the cooking duration

- Check whether the food is cooked shortly before the end of the specified cooking duration.



## Tips

- For frozen meat, increase the cooking duration by approx. 10 minutes per lb (20 minutes per kg).
- Frozen meat weighing less than approx. 3.3 lb (1.5 kg) does not need to be defrosted before roasting.

# Roasting

## Notes on the operating modes

You can find an overview of all the operating modes with their recommended values in “Main and submenus”.



Use the Bake  operating mode towards the end of the cooking duration to brown the base of the food. Do not use the Intensive  operating mode for roasting as the juices will become too dark.

## Using Automatic Programs

- Follow the instructions on the display.

## Using Convection Roast or Auto Roast

These operating modes are suitable for roasting meat, fish, and poultry that needs to be well browned, as well as roast beef and fillet.

The Convection Roast  operating mode allows you to use a lower temperature than you would with the Surround  operating mode, because the heat is immediately distributed throughout the oven cavity.

With the Auto Roast  operating mode, the oven cavity initially heats to the highest temperature in this operating mode for searing. As soon as this temperature has been reached, the oven automatically drops the temperature back down to the preselected cooking temperature (continued roasting temperature).

- For roasting, use dishware with heat-resistant handles such as an oven dish, roasting pan, terracotta dish, or a heat-resistant glass dish.
- Place the wire rack with the food on shelf level 1.

## Using Combi Conv Roast or Combi Auto Roast

These operating modes are **not** suitable for roasting delicate cuts of meat such as sirloin joints or fillet. The center would be too well cooked before the exterior is browned.

Use the Combi Conv Roast  operating mode for rapid reheating and cooking of food while browning it at the same time. This operating mode saves the most time and energy.

Use the Combi Auto Roast  operating mode for searing using a high temperature to start with, then continue cooking with a lower temperature.

If you use operating modes which use microwave power, the cooking duration is shortened.

- Dishware must be suitable for use in a microwave oven, must be heat-resistant, and must not have metal lids (see “Microwave operation – Suitable dishware”).
- Place the wire rack together with the glass tray or the glass tray on shelf level 1.



## Probe

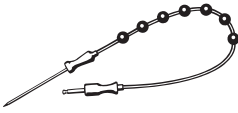

The food probe allows you to monitor the cooking process simply and reliably.

### How it works

The metal tip of the food probe must be fully inserted into the center of the food all the way to the handle. There is a temperature sensor in the metal tip which measures the core temperature of the food during the cooking process. The rise in the core temperature reflects the extent to which the food is cooked. You can program the core temperature to be lower or higher, depending on whether you want your meat to be rare, medium, or well done.







The core temperature can be set up to 210°F (99°C). Information on food and respective core temperatures can be found in the cooking charts at the end of this book.

The cooking duration will be similar for cooking processes with or without the food probe.

### When to use the probe

Some automatic programs and Special Modes will prompt you to use the probe.

You can also use the probe with Favorites and with the following operating modes:

- Auto Roast 
- Convection Roast 
- Surround 
- Microwave 
- Combi Auto Roast 
- Combi Conv Roast 

### Important usage notes

- You can place the meat in a pot, on the wire rack, or on the glass tray, depending on the operating mode selected.
- The metal tip of the probe must be fully inserted into the center of the food so that the temperature sensor reaches more or less to the core.
- When cooking poultry, insert the metal part into the thickest part of the breast. You can find the thickest part of the breast by pressing the area with your thumb and index finger.
- The metal tip must not touch any bone or be inserted in areas with a lot of fat. Fatty tissue and bones can cause the probe to turn off early.
- When using aluminum foil or roasting bags, insert the probe through the foil/bag into the center of the food. You can also place meat inside the bag or foil with the probe already inserted. Be sure to follow the instructions provided by the manufacturer of the roasting bag or aluminum foil.

# Roasting

## Using the probe

- Fully insert the metal tip of the probe into the center of the meat all the way to the handle.

If you are cooking several pieces of meat at the same time, insert the probe into the largest piece of meat.

- Place the food in the oven.

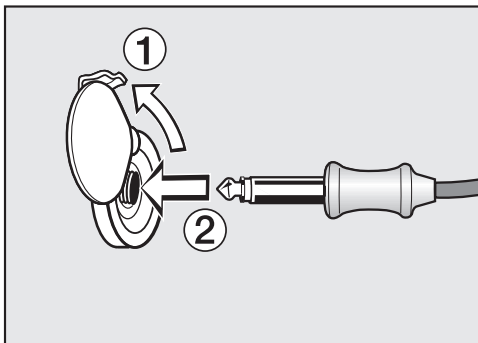

- Insert the plug of the probe into the socket until you feel it engage.
- Close the door.
- Select an operating mode or automatic program.
- Set the temperature and the core temperature if necessary.

Core temperatures cannot be changed for automatic programs.

Follow the instructions on the display.

The cooking program finishes as soon as the core temperature is reached.

**⚠ Risk of injury caused by hot surfaces.**

The probe can get hot. You could burn yourself on it.

Use pot holders when removing the probe from its socket.

## Delaying the start of a cooking program with probe

You can also delay the start of the cooking program to a later time.

- Select Start at.

You can estimate approximately when the food will be ready as the duration of the cooking program is about the same as if you were cooking food without using the probe.

You cannot set Duration and Ready at because the total cooking duration is determined by when the set core temperature is reached.

## Time-left display

If the temperature set for a cooking process is above 285°F (140°C), the estimated duration remaining (time left) will appear on the display.

The time left is calculated from the cooking temperature selected, the set core temperature, and the progress of the core temperature as it rises.

The time left first shown is an estimate. As the cooking process continues, the time left is revised continuously, and a more accurate figure is shown.

The time left will be deleted if the cooking temperature or core temperature is changed or if a different operating mode is selected. If the door is opened for a longer time, the time left will be recalculated.

 Risk of injury caused by hot surfaces.

If you broil with the door open, the hot air will escape from the oven before it has been cooled by the cooling fan. The control elements will get hot.



Broil with the oven door closed.

Always observe USDA/CFIA food safety guidelines.

## Tips for broiling



- Preheating is necessary when broiling. For preheating, select an operating mode which **does not use** microwave power. Preheat the browning/broiling element for approx. 5 minutes with the door closed.
- Add a little oil to lean meat if necessary. Do not use other types of fat as they can easily burn and cause smoke.
- Clean fish in the normal way. To enhance the flavor, season with a little salt. You can also drizzle the fish with lemon juice.
- It is generally best to broil on the wire rack.
- To broil, brush the wire rack with oil and then place the food on the wire rack.

## Selecting the temperature



Select the temperature for the Convection Broil  and Combi Conv Broil  operating modes.

- As a general rule, select the lower temperature given in the chart. If higher temperatures are used than those specified, the meat will brown on the outside, but will not be properly cooked through.

## Selecting the broiling setting

Select between levels 1–3 for the Maxi Broil  and Combi Broil  operating modes.

- If you are broiling thicker foods further away from the broiling element, select **level 1**.
- If you desire a lighter, golden finish, on gratins for example, select **level 2**.
- If you are quickly broiling thinner foods closer to the broiling element, select **level 3**.

Set the microwave power level , the broiling level , and the cooking duration.

# Broiling

## Selecting the cooking duration

- Broil thinner cuts of meat/slices of fish for approx. 6–8 minutes per side. It is best to broil food of a similar thickness at the same time so that the cooking durations do not vary too much.
- Broil thicker pieces for about 7–9 minutes per side.
- When broiling rolled meat, allow approx. 10 minutes per 1/2" (1cm) diameter.
- Check whether the food is cooked shortly before the end of the specified cooking duration.

**Tip:** If the surface of a thicker cut of meat is browned but the center is still raw, move the food to a lower level or reduce the temperature and continue broiling. This will stop the surface from becoming too dark.

## Notes on the operating modes

You can find an overview of all the operating modes with their recommended values in “Main and submenus”.

The plastic on the probe can melt at very high temperatures.  
Do not use the probe when using the broiling operating modes.  
Do not store the probe in the oven compartment when it is not being used.

If you use operating modes which use microwave power, the cooking duration is shortened.

## Using Convection Broil or Combi Conv Broil

These operating modes are suitable for broiling thicker food, such as chicken. We generally recommend a temperature setting of 425°F (220°C) for thinner types of food and 350–400°F (180–200°C) for thicker cuts.

- Place the wire rack on shelf level 1 or 2 depending on the height of the food.

## Using Maxi Broil or Combi Broil

These operating modes are suitable for broiling thin cuts of meat and browning food.

- Place the wire rack on shelf level 2 or 3 depending on the height of the food.

# Cleaning and care of the oven

 Danger of injury caused by hot surfaces.

The oven gets hot during operation. You could burn yourself on the heater elements, oven cavity, or accessories. Allow the heater elements, oven cavity, and accessories to cool before manual cleaning.

 Risk of injury due to electric shock.

The steam from a steam cleaning appliance could reach live electrical components and cause a short circuit. Never use a steam cleaner for cleaning.

All surfaces could be discolored or damaged if unsuitable cleaning agents are used. The oven front is particularly susceptible to damage from oven cleaners.

All surfaces are susceptible to scratching. Scratches on glass can lead to breakage in some circumstances.

Remove all cleaning agent residues immediately.

Stubborn soiling may damage the oven.

Once the oven has cooled, clean the oven cavity, the inside of the door, and the door seal. Waiting too long to clean the oven will make it much more difficult to clean.

Operating a damaged oven can result in microwave leakage and present a hazard to the user.

Check the door and door seal for any sign of damage. If any damage is seen, the oven should not be used again. Contact Miele.

## Unsuitable cleaning agents

To avoid damaging the surfaces of your appliance, do not use:

- cleaning agents containing soda, ammonia, acids, or chlorides
- cleaning agents containing descaling agents on the front
- abrasive cleaning agents (e.g., powder cleaners and cream cleaners)
- solvent-based cleaning agents
- stainless steel cleaning agents
- dishwasher cleaners
- glass cleaners
- cleaning agents for ceramic glass cooktops
- hard, abrasive brushes or sponges (e.g., pot scourers, brushes, or sponges which have been previously used with abrasive cleaning agents)
- eraser sponges
- sharp metal scrapers
- steel wool
- spot cleaning with mechanical cleaning agents
- stainless steel spiral pads

# Cleaning and care of the oven

---

If soiling is allowed to sit for any length of time, it may become impossible to remove. If items are used frequently without being cleaned, it may become very difficult to clean them.  
It is therefore best to remove any soiling immediately.

Only the glass tray is dishwasher proof.

**Tip:** Soiling caused by spilled fruit juices and cake mixtures is best removed while the oven is still warm. Use caution and make sure the oven is not too hot.

To make it easier to clean the oven:

- Lower the browning/broiling element.
- To neutralize odors in the oven compartment, put a container of water with some lemon juice in the oven and heat for a few minutes.

## Removing normal soiling

Moisture inside the oven can cause damage.

Do not use too much water on the cloth or sponge and do not let water or any other liquid find its way into any oven cavity openings.

## Removing normal soiling

- Remove normal soiling immediately with warm water, liquid dish soap, and a clean sponge or a clean, damp microfiber cloth.
- Remove all cleaning agent residues thoroughly with clean water. This is particularly important for any parts with a PerfectClean finish, as cleaning agent residues will impair the non-stick function.
- After cleaning, wipe the surfaces dry using a soft cloth.

## Cleaning the probe

Do not put the probe into water or clean it in the dishwasher as this will damage it.

Clean the probe with a damp cloth only.

# Cleaning and care of the oven

## Removing stubborn soiling

Spilt fruit and roasting juices may cause lasting discoloration or matte patches on surfaces. This discoloration will not affect the properties of the surface finish. Do not attempt to remove these stains. Clean them following the instructions given here.

- Moisten stubborn soiling with a solution of hot water and washing-up liquid and leave to soak for a few minutes.
- If necessary, the scouring pad on the back of a washing-up sponge can be used to remove the soiling after the soaking time.

## Using oven cleaners

- Very stubborn soiling on PerfectClean surfaces can be cleaned using Miele Oven Cleaner. This cleaner must only be applied to cold surfaces.

If the oven spray gets into gaps and openings, a strong odor is generated during subsequent cooking processes.

Do not spray the oven cleaner onto the ceiling of the oven.

Do not spray the oven cleaner into the gaps and openings of the oven cavity walls and rear wall.

- Leave the oven cleaner to work according to the instructions on the packaging.

Oven cleaners from other manufacturers must only be used in a cold oven and not left on for longer than a maximum of 10 minutes.

- If necessary, you can use the scouring pad on the back of a non-scratching dish sponge to remove the soiling after the holding time.
- Remove all cleaning agent residues thoroughly with clean water.
- Dry all surfaces with a soft cloth.

## Lowering the browning/broiling element

If the ceiling of the oven is badly soiled, the browning/broiling element can be lowered to make cleaning easier. Clean the ceiling of the oven regularly with a damp cloth or a dish sponge.

 Danger of injury caused by hot surfaces.

The oven gets hot during operation. You could burn yourself on the heater elements, oven cavity, or accessories. Allow the heater elements, oven cavity, and accessories to cool before manual cleaning.

The oven cavity floor can be scratched by the falling nut. Place a cloth or similar item over the oven floor to protect it.

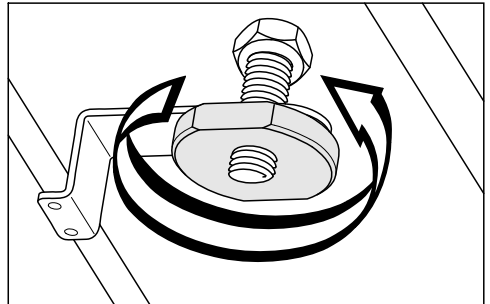

- Unscrew the nut.

## Cleaning and care of the oven

---

Take care not to damage the browning/broiling element.  
Do not use force when lowering the browning/broiling element.

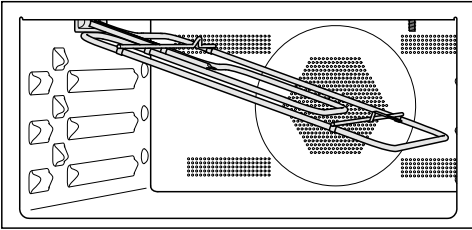

- Carefully lower the browning/broiling element.

The liner on the ceiling of the oven can be damaged.  
Do not use the abrasive side of the dishwashing sponge to clean the ceiling of the oven.

The LED on the ceiling of the oven can be damaged.  
Do not clean the LED if possible.

- Clean the ceiling of the oven with a damp cloth or a soft sponge.
- After cleaning, raise the browning/broiling element gently back up again.
- Replace the nut and tighten it securely.







## Frequently asked questions

Many malfunctions and faults that can occur in daily operation can be easily remedied. You can save time and money in many cases, as you do not need to contact Miele Customer Service.

Information to help you rectify faults yourself can be found at [www.miele.com/service](http://www.miele.com/service).



The following tables are designed to help you to find the cause of a malfunction or a fault and to resolve it.

Problem	Possible cause and solution
<b>The display is dark.</b>	You have selected the Time   Display   Off setting. When the oven is turned off, the time-of-day display is dark. <ul style="list-style-type: none"> <li>■ As soon as the oven is turned on, the main menu will appear. If you want the time of day to be displayed constantly, select the Time   Display   On setting.</li> </ul>
	There is no power to the oven. <ul style="list-style-type: none"> <li>■ Check that the oven's electrical plug is correctly inserted in the socket and that the circuit breaker has been switched to on.</li> <li>■ Check if the breaker has tripped. If it has, contact a qualified electrician or Miele Customer Service.</li> </ul>
<b>The audible signal does not sound.</b>	The audible signals are deactivated or set at too low a volume. <ul style="list-style-type: none"> <li>■ Turn on the audible signals or increase the volume with Settings   Volume   Buzzer Tones.</li> </ul>
<b>The oven does not heat up.</b>	Demo mode is activated. You can select menu options on the display and sensor buttons, but the oven heating does not work. <ul style="list-style-type: none"> <li>■ Deactivate Demo mode by selecting Settings   Showroom Program   Demo Mode   Off.</li> </ul>
<b>System Lock  appears on the display when the oven is turned on.</b>	The  system lock is activated. <ul style="list-style-type: none"> <li>■ You can deactivate the system lock for a cooking program by touching the  symbol for at least 6 seconds.</li> <li>■ If you want to permanently deactivate the system lock, select the Safety   System Lock    Off setting.</li> </ul>

## Frequently asked questions

Problem	Possible cause and solution
<p><b>You cannot start a cooking process.</b></p>	<p>If you are cooking with microwave power, the door may be open.</p> <ul style="list-style-type: none"> <li>■ Check whether the door is closed properly.</li> </ul>
	<p>If you are cooking with microwave power, the power level or cooking duration is not selected.</p> <ul style="list-style-type: none"> <li>■ Check whether a microwave power level and a duration have been selected.</li> </ul>
	<p>If you are cooking with an operating mode which uses microwave power, not all of the required settings have been entered.</p> <ul style="list-style-type: none"> <li>■ Check whether a microwave power level, a cooking duration, and a temperature have been selected.</li> </ul>
<p><b>The sensor buttons or the proximity sensor do not respond.</b></p>	<p>You have selected the <b>Display   QuickTouch   Off</b> setting. When this is activated, the sensor buttons and proximity sensor do not respond when the oven is turned off.</p> <ul style="list-style-type: none"> <li>■ As soon as the oven is turned on, the sensor buttons and the proximity sensor will respond. If you want the sensor buttons and the proximity sensor to respond even when the oven is turned off, select the <b>Display   QuickTouch   On</b> setting.</li> </ul>
	<p>The settings for the proximity sensor are turned off.</p> <ul style="list-style-type: none"> <li>■ Change the settings for the proximity sensor by selecting <b>Settings   MotionReact</b>.</li> </ul>
	<p>The proximity sensor is defective.</p> <ul style="list-style-type: none"> <li>■ Contact Miele Customer Service.</li> </ul>
	<p>The oven is not connected to the domestic electrical supply.</p> <ul style="list-style-type: none"> <li>■ Make sure that the plug is correctly inserted in the socket and that the socket switch has been switched to on.</li> <li>■ Check if the breaker has tripped. If it has, contact a qualified electrician or Miele Customer Service.</li> </ul>
	<p>If the display does not respond, there is a fault with the controls.</p> <ul style="list-style-type: none"> <li>■ Touch and hold the  <b>On/Off</b> button until the display turns off and the oven restarts.</li> </ul>

## Frequently asked questions

Problem	Possible cause and solution
Power failure -Program cancelled <b>appears on the display.</b>	<p>There has been a brief power failure. This has caused the current cooking process to stop.</p> <ul style="list-style-type: none"> <li>■ Turn the oven off and then back on again.</li> <li>■ Restart the cooking process.</li> </ul>
12:00 <b>appears on the display.</b>	<p>There was a power failure for more than 150 hours.</p> <ul style="list-style-type: none"> <li>■ Reset the date and time.</li> </ul>
Maximum operating duration reached <b>appears on the display.</b>	<p>The oven has been operating for an unusually long time. This has triggered the safety shut-off.</p> <ul style="list-style-type: none"> <li>■ Confirm with <i>OK</i>.</li> </ul> <p>The oven is now ready to use again.</p>
Fault <b>and a fault code not listed here appear on the display.</b>	<p>A fault has occurred that you cannot resolve.</p> <ul style="list-style-type: none"> <li>■ Contact Miele Customer Service.</li> </ul>
<b>If the door is opened during a cooking process using the Microwave  operating mode, the oven stops making noise.</b>	<p>This is not a fault. If the door is opened during a cooking process using the Microwave  operating mode, the door contact switch will switch off microwave power and switch the cooling fan to a lower speed.</p>
<b>You can hear a noise after a cooking program.</b>	<p>The cooling fan remains turned on after a cooking program (see “Settings – Cooling fan run-on”).</p>
<b>An abnormal sound can be heard when the oven is operating in microwave mode.</b>	<p>A metal dish has been used during a cooking process using microwave power.</p> <ul style="list-style-type: none"> <li>■ Check if there are sparks caused by using metal dishes (see “Microwave operation – Suitable dishware”).</li> </ul>
	<p>The food was covered with aluminum foil during a cooking process using microwave power.</p> <ul style="list-style-type: none"> <li>■ If it is, remove the foil.</li> </ul>
	<p>The wire rack was used during a cooking process using microwave power.</p> <ul style="list-style-type: none"> <li>■ Always use the glass tray when using the oven with microwave power.</li> </ul>
<b>The oven has turned itself off.</b>	<p>To save power, the oven turns off automatically if a button is not pressed after a certain amount of time or after a cooking program has ended.</p> <ul style="list-style-type: none"> <li>■ Turn the oven back on.</li> </ul>

## Frequently asked questions

Problem	Possible cause and solution
<p><b>The cake/cookies are not baked properly.</b></p>	<p>A different temperature than that given in the recipe was used.</p> <ul style="list-style-type: none"> <li>■ Select the temperature required for the recipe.</li> </ul>
	<p>The ingredient quantities are different from those given in the recipe.</p> <ul style="list-style-type: none"> <li>■ Check if you have amended the recipe. The addition of more liquid or more eggs will make a wetter mixture which will take longer to cook.</li> </ul>
<p><b>The browning is uneven.</b></p>	<p>You selected the wrong temperature or shelf level.</p> <ul style="list-style-type: none"> <li>■ There will always be a slight unevenness. If browning is very uneven, check whether you selected the correct temperature and shelf level.</li> </ul>
	<p>The material or color of the bakeware is not suitable for the operating mode selected. Light-colored, shiny, or thin-walled pans are less suitable. These reflect the oven's heat, which means that the heat does not penetrate to the food effectively, resulting in uneven or poor browning.</p> <ul style="list-style-type: none"> <li>■ Dark, matte baking pans are best for baking.</li> </ul>
<p><b>The food is not sufficiently heated or is not cooked at the end of a set duration when using the Microwave  operating mode.</b></p>	<p>Check whether the cooking process using microwave power has been interrupted and has not been restarted.</p> <ul style="list-style-type: none"> <li>■ Restart the cooking process to ensure the food is heated or cooked properly.</li> </ul>
	<p>When cooking or reheating with microwave power, the time set was too short.</p> <ul style="list-style-type: none"> <li>■ Check that the correct duration is selected for the microwave power level. The lower the microwave power level, the longer the duration required.</li> </ul>

## Frequently asked questions

Problem	Possible cause and solution
<p><b>Food has cooled down too quickly after being reheated or cooked using microwave power.</b></p>	<p>In the microwave, food begins to cook from the outside first, the inside of the food relying on the slower conduction of heat. If food is cooked at a high microwave power level, it is possible that the heat may not have reached the center of the food, so it is hot on the outside but cold in the centre. During the standing time, the heat is transferred to the center of the food.</p> <ul style="list-style-type: none"> <li>■ When reheating food with different densities, such as with menu cooking, it is sensible to start with a low microwave power level and select a longer reheating duration.</li> </ul>
<p><b>The oven interior lighting turns off after a short time.</b></p>	<p>You have selected the Lighting   “On” for 15 seconds setting.</p> <ul style="list-style-type: none"> <li>■ If you want the oven interior lighting to remain on during the entire cooking program, select the Lighting   On setting.</li> </ul>
<p><b>The oven interior lighting is off or does not turn on.</b></p>	<p>You have selected the Lighting   Off setting.</p> <ul style="list-style-type: none"> <li>■ Press the <i>Light</i> sensor button to turn the oven interior lighting on for 15 seconds.</li> <li>■ If required, select the Lighting   On or “On” for 15 seconds setting.</li> </ul> <p>The oven interior lighting is faulty.</p> <ul style="list-style-type: none"> <li>■ Contact Miele Customer Service.</li> </ul>

## Customer Service

---

Information to help you rectify faults yourself and about Miele spare parts can be found at [www.miele.com/service](http://www.miele.com/service).

### Contact in the event of a fault

In the event of a fault which you cannot remedy yourself, please contact your Miele dealer or Miele Customer Service.

You can book a Miele Service Call online at [www.miele.com/service](http://www.miele.com/service).  
Contact information for Miele Customer Service can be found at the end of this document.

Please quote the model identifier and serial number of your appliance (SN) when contacting Miele Customer Service. Both pieces of information can be found on the data plate.

This information is given on the data plate, which is visible on the front frame of the oven when the door is fully open.

### Appliance warranty and product registration

You can register your product and/or view the manufacturer's warranty terms and conditions for Miele appliances and vacuum cleaners at [www.mieleusa.com](http://www.mieleusa.com).

### Disposal of the packing material

The cardboard box and packing materials protect the appliance during shipping. They have been designed to be biodegradable and recyclable.

Ensure that any plastic wrappings, bags, etc. are disposed of safely and kept out of the reach of children. Danger of suffocation!

### Disposal of your old appliance

Electrical and electronic appliances contain valuable materials. They also contain certain substances, compounds and components which were essential for the proper functioning and safe use of the equipment. Handling these materials improperly by disposing of them in your household waste can be harmful to your health and the environment. Therefore, please do not dispose of your old appliance with regular household waste and follow local regulations on proper disposal.



Consult with local authorities, dealers or Miele in order to dispose of and recycle electrical and electronic appliances. Miele assumes no responsibility for deleting any personal data left on the appliance being disposed. Please ensure that your old appliance is kept away from children until removal. Observe safety requirements for appliances that may tip over or pose an entrapment hazard.

# Installation

## Installation dimensions H 7840 BM

The example shows installation in a 30" niche with trim kit EBA 7xxx.

### Installation in a tall or base cabinet

Miele Ovens can be installed flush or proud. Discuss your requirements with your architect, kitchen designer, and installer.

More installation drawings are available on the Miele website.

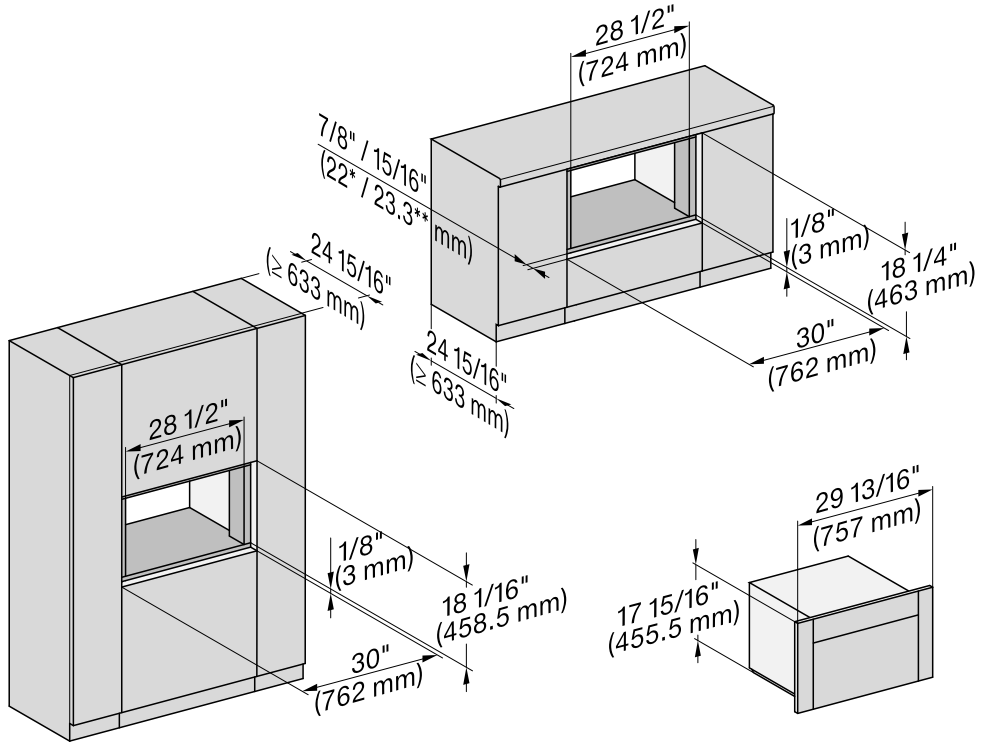

\* Oven with glass front

\*\* Oven with metal front



Side view

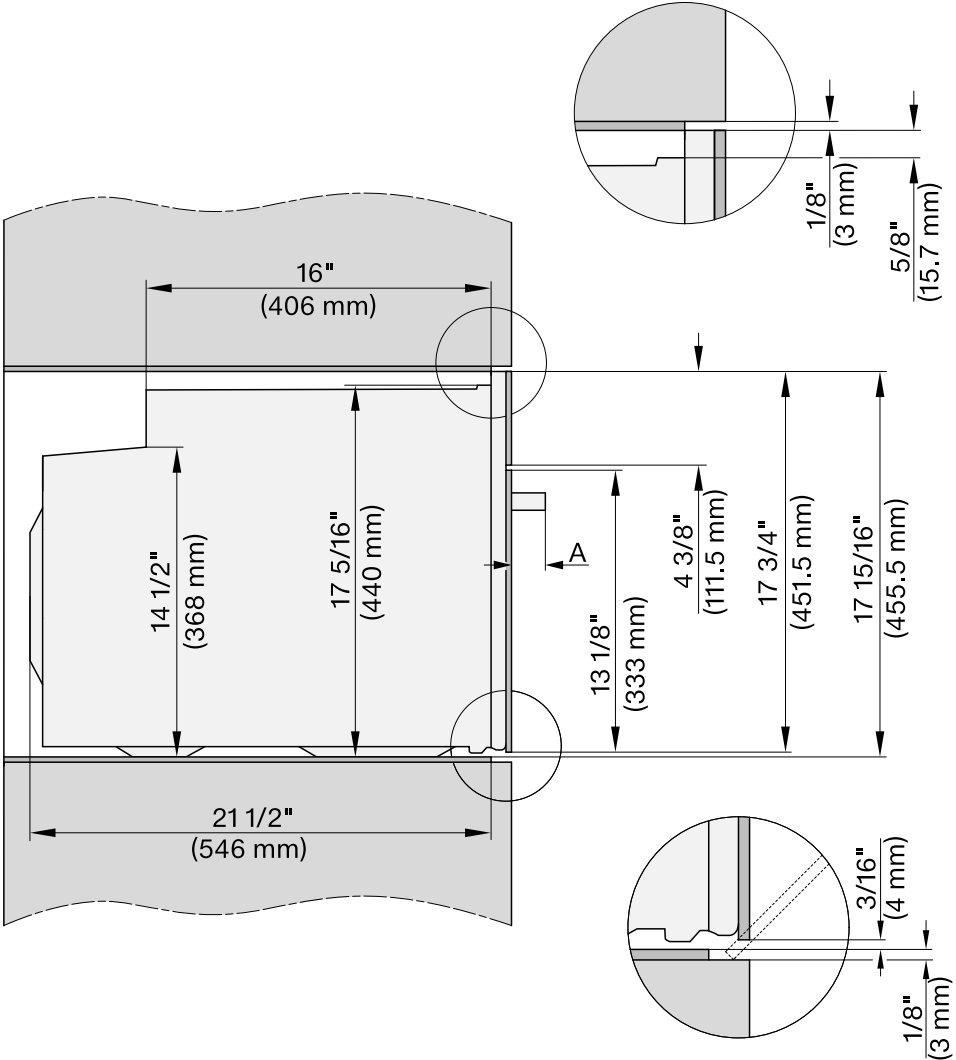

A H 78xx: 17/8" (47 mm)

# Installation

## Connections and ventilation

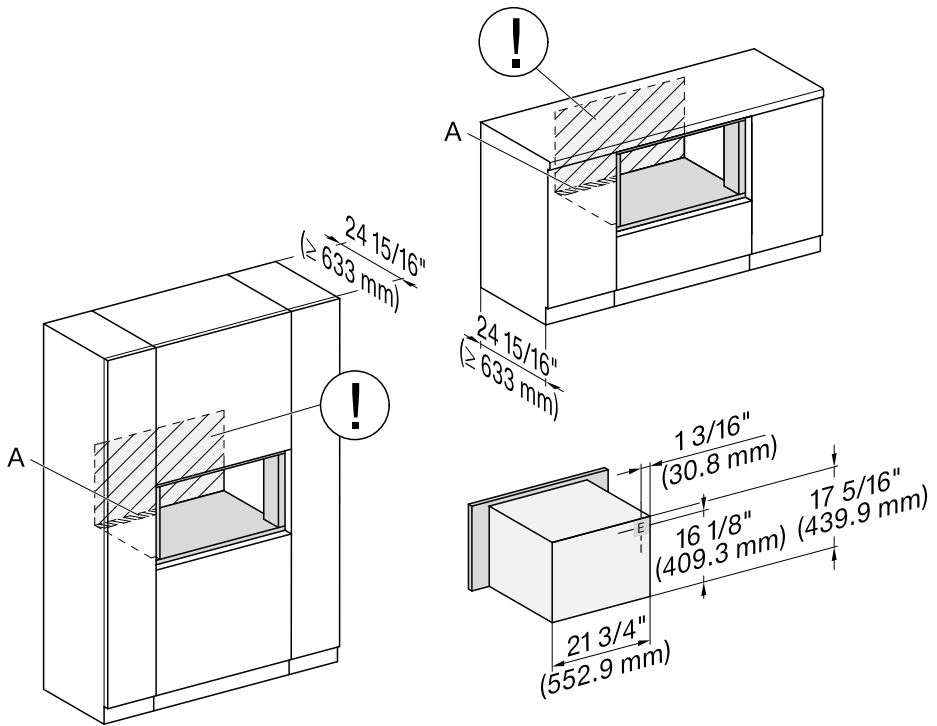

- A** Cutout  $4'' \times 28 \frac{3}{8}''$  ( $100 \text{ mm} \times 720 \text{ mm}$ ) in the base of the kitchen cabinet for power cord and ventilation
- ① The outlet for the electrical connection should be accessible, e.g., in an adjacent kitchen cabinet. If the electrical connection is behind the oven, the kitchen cabinet needs to be deeper than specified.
- E** Electrical connection

## Installation dimensions H 7770 BM, H 7870 BM

### Installation in a tall or base cabinet

Miele Ovens can be installed flush or proud. Discuss your requirements with your architect, kitchen designer, and installer.

More installation drawings are available on the Miele website.

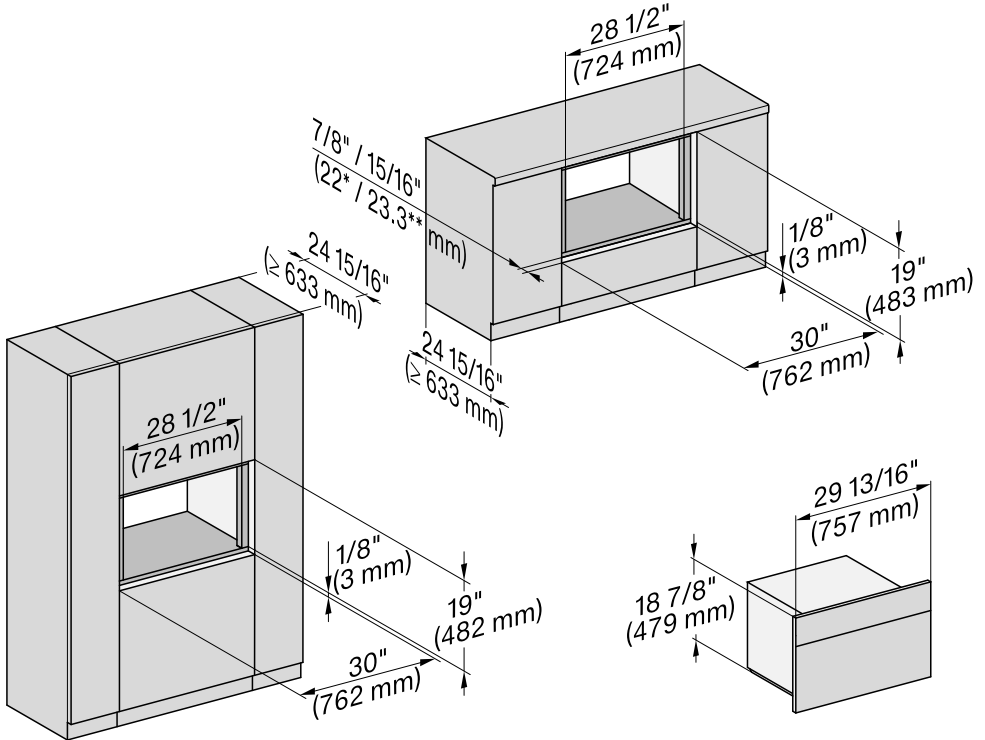

\* Oven with glass front

\*\* Oven with metal front

# Installation

## Side view

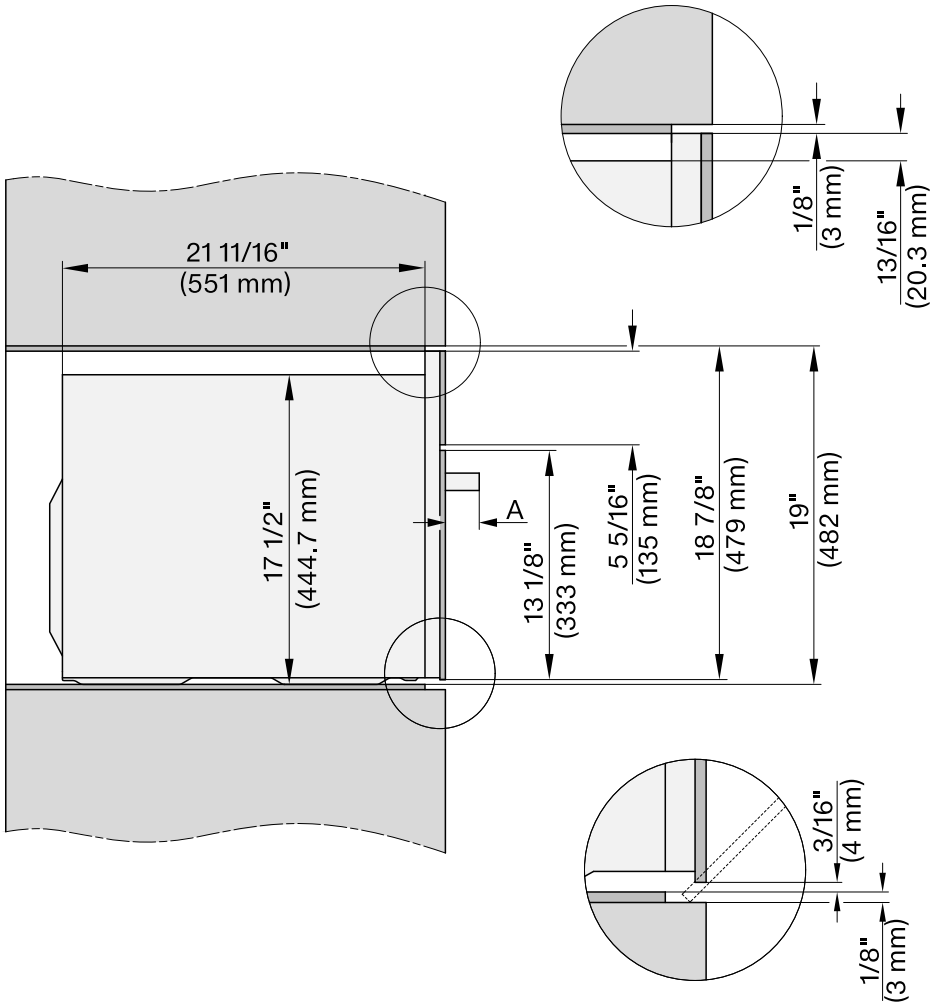

- A** H 77xx: 2  $\frac{1}{2}$ " (64 mm)  
H 78xx: 1  $\frac{7}{8}$ " (47 mm)

## Connections and ventilation

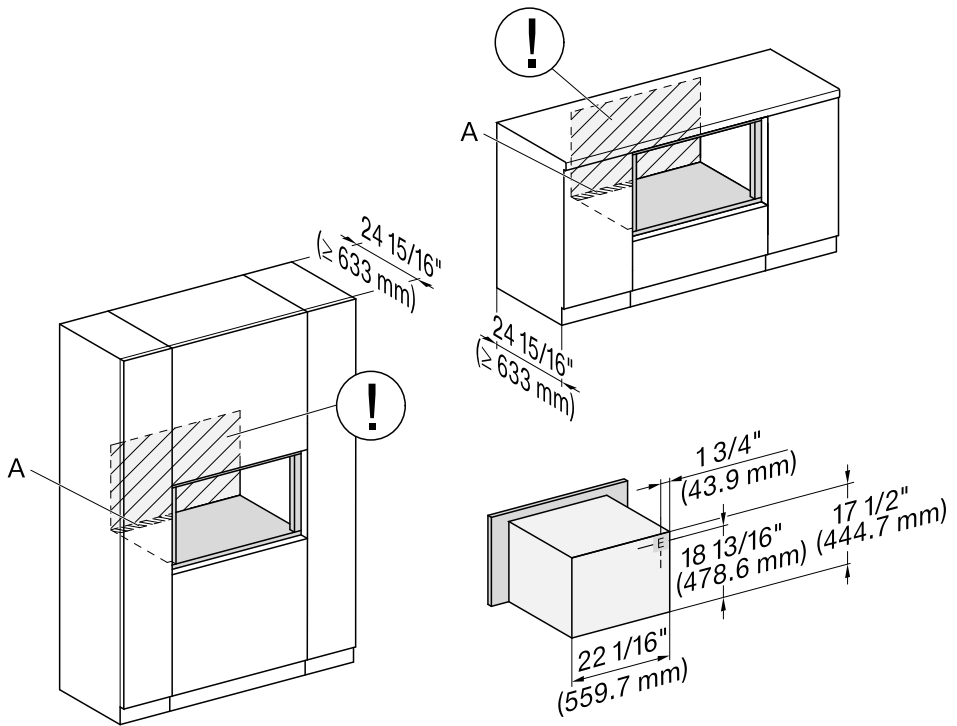

- A** Cutout  $4'' \times 28 \frac{3}{8}''$  ( $100 \text{ mm} \times 720 \text{ mm}$ ) in the base of the kitchen cabinet for power cord and ventilation
- ⓘ The outlet for the electrical connection should be accessible, e.g., in an adjacent kitchen cabinet. If the electrical connection is behind the oven, the kitchen cabinet needs to be deeper than specified.
- E** Electrical connection

# Installation

## Installing and removing the oven

For safety reasons, only use the oven when it has been fully installed.

Do not open the door when the oven is on the floor. This could damage the door.

Do not open the door until the oven has been installed inside the housing unit.

## Fixing the handle (depending on model)

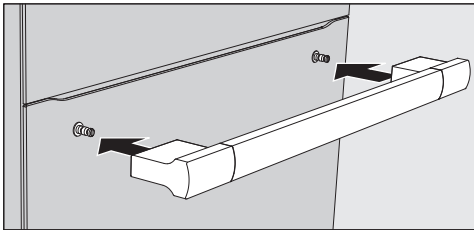

- Install the handle on the pins.

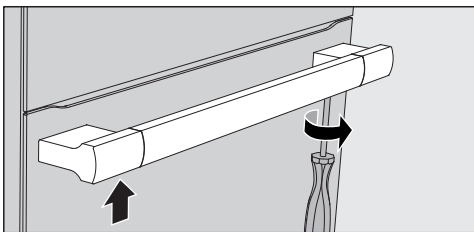

- Tighten the four screws with the screwdriver supplied.

## Securing the oven in the housing unit

- Connect the oven to the power supply.

Do not carry the oven by the door handle. This could damage the door. Use the carry handles on the side of the housing to lift the appliance.

- Push the oven into the housing unit far enough for you to be able to remove the carry handles.

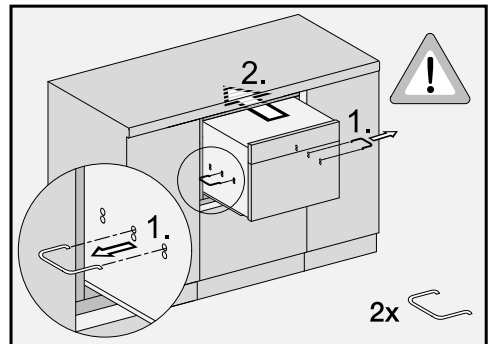

- Remove the carry handles (1.). Keep the carry handles in case the oven needs to be moved again in the future.
- Push the oven all the way into the housing unit and align it in the center of the unit (2.).

- Open the door.

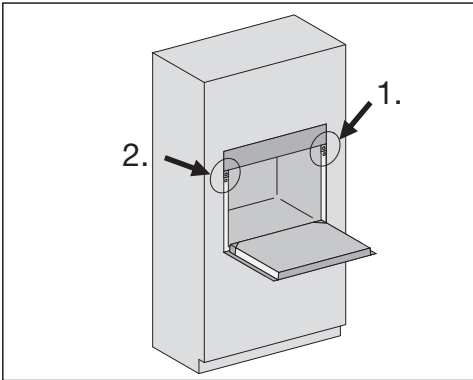

- Insert the bolt into the mounting aid and tighten it in the cabinet niche. **Do not** use a cordless screwdriver.

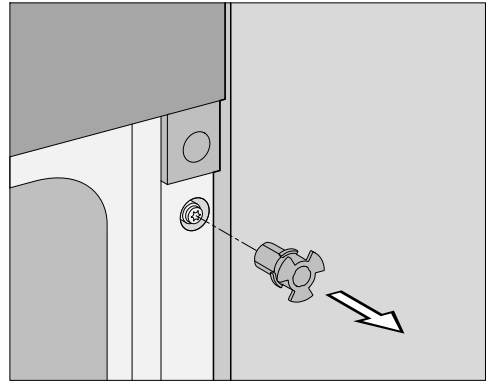

- Remove the mounting aid.

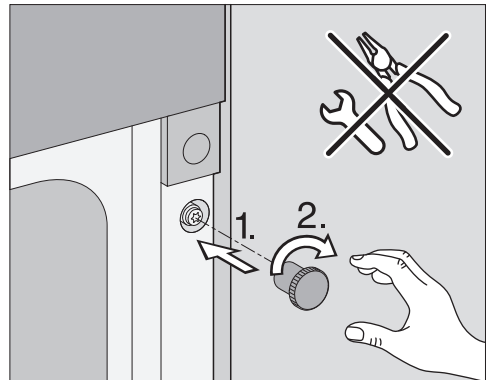

- Insert the mounting aid into the hole in the front frame.

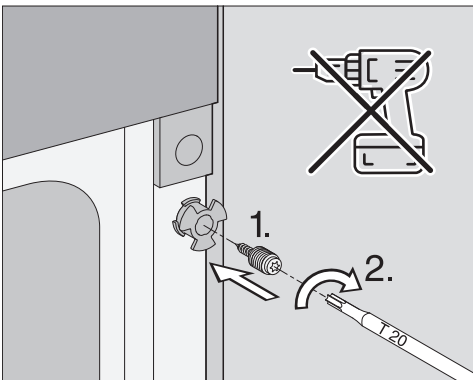

- Screw the knurled nut onto the bolt by hand to fix the oven in the cabinet niche.

The door may be damaged if the knurled nuts protrude from the front frame.  
Make sure that the knurled nuts are flush with the front frame after installation.

- Repeat this process for the other side.

# Installation

## Taking the oven out of the housing unit

- Open the door.
- Unscrew the knurled nuts and bolts from the front frame (see “Securing the oven in the housing unit”).  
Keep these parts in case the oven needs to be installed again in the future.

 Risk of injury caused by dropping the appliance.

The oven can tip forward and cause serious injuries if the carry handles are inserted into the holes at the back.

Always insert the carry handles into the holes at the **front** of the side wall.

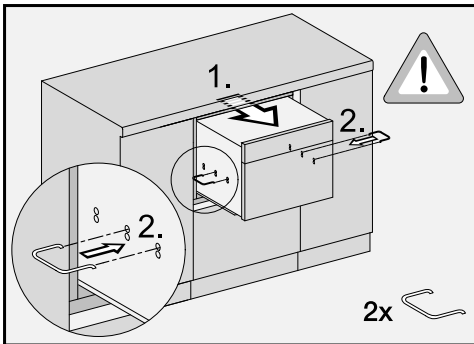

- Pull the oven out of the housing unit until the holes for the carry handles are visible (1.).
- Insert the carry handles into the holes at the **front** at the top of the side walls on each side of the oven (2.).

Do not carry the oven by the door handle. This could damage the door. Use the carry handles on the side of the housing to lift the appliance.

- Take the oven out of the housing unit.
- Disconnect the oven from the power supply.



## Electrical connection

 Risk of injury due to electric shock.

During installation, maintenance, and repair work, the oven must be completely disconnected from the power supply:

Disconnect the oven from the power supply by tripping the breakers, or unplugging the power cord from the outlet. To do this, pull the plug not the cord.

 Risk of injury.

Installation, repairs, and other work by unqualified persons could be dangerous. Miele cannot be held liable for unauthorized work.

Installation, maintenance, and repairs must only be carried out by a Miele authorized technician.

The connection data (voltage and frequency) on the data plate of the oven must match the power supply in order to avoid the risk of damage to the oven.

Compare this before connecting the appliance to the power supply. If in any doubt, consult a qualified electrician.

For safety reasons, the oven may only be used when it has been fully installed.

The power cord plug must be inserted into a suitable outlet that has been installed and grounded in compliance with all applicable local codes.

**WARNING: THIS APPLIANCE MUST BE GROUNDED**

**Installer: Please pass these instructions on to the customer.**

# Installation

---

## Electrical connection

The oven is equipped with a power cord approx. 6 ft (1.8 m) long with a 4-pin NEMA 14-30P plug for connection to a power supply with:

- 2NAC 208 V, 30 A, 60 Hz
- or
- 2NAC 240 V, 30 A, 60 Hz

Temporary or permanent operation on an autonomous power supply system or a power supply system that is not synchronized with the grid power supply (e.g., island networks, back-up systems) is possible. A prerequisite for operation is that the power supply system complies with the specifications of EN 50160 or an equivalent standard. The function and operation of the protective measures provided in the domestic electrical installation and in this Miele product must also be maintained in isolated operation or in operation that is not synchronized with the grid power supply, or these measures must be replaced by equivalent measures in the installation. As described, for example, in the current version of VDE-AR-E 2510-2.

You can set the voltage variant (see “Settings – Electrical version”).

**KEEP THE OPERATING AND INSTALLATION INSTRUCTIONS IN A SAFE PLACE.**

## Supplier's Declaration of Conformity 47 CFR § 2.1077 Compliance Information

### Microwave Function

**Unique Identifier:** Miele Model:  
H 7840 BM, H 7770 BM or H 7870 BM

### Responsible Party

Miele, Inc.  
National Headquarters  
9 Independence Way  
Princeton, NJ 08540  
Phone: 800-843-7232  
Fax: 609-419-4298  
www.mieleusa.com

**FCC Compliance Statement:** This device complies with Part 18 of the FCC Rules.

Regarding radiological health this product complies with DHHS rules 21 CFR Subchapter J.

### IC Compliance Statement:

This device complies with **CAN ICES-001 (B) / NMB-001 (B)**

## Radio Module

This device contains the following WiFi module:

FCC ID	2AC7Z-EK057
IC ID	21098-EK057
Frequency band	2.412 GHz – 2.462 GHz
Maximum transmitting power	< 0.2 W

### Compliance Statement

This device complies with Part 15 of the FCC Rules and contains licence-exempt transmitter(s)/receiver(s) that comply with Innovation, Science and Economic Development Canada's licence-exempt RSS Standard(s).

Operation is subject to the following two conditions:

- (1) this device may not cause harmful interference, and
- (2) this device must accept any interference received, including interference that may cause undesired operation.

The construction of the device assures that the FCC/IC exposure limits are verifiably met using the integrated radio module.

### Warning!

Any changes or modifications to this unit not expressly approved by the party responsible for compliance could void the user's authority to operate the equipment.

# Copyrights and licenses

---

Miele uses their own and third party software which is not subject to any so-called open source license for the operation and control of the device/appliance. This software/these software components are protected by copyright. The copyright powers of Miele and third parties have to be respected.

Furthermore, this device/appliance contains software components which are distributed under open source license conditions. Please refer to [Settings | Legal information | Open source licenses](#) in the device/appliance for the open source components contained therein, together with the corresponding copyright notices, copies of the licensing conditions valid at the time, and any further information. The liability and warranty provisions of the open source licensing conditions as stated therein apply only in relation to the respective rights holders.

In particular, the device/appliance contains software components licensed by the copyright holders under the GNU General Public License, Version 2, or the GNU Lesser General Public License, Version 2.1. For a period of at least 3 years from the date of purchase or delivery of the device/appliance respectively, Miele offers to provide you or third parties with a machine-readable copy of the source code of the Open Source components contained in the device/appliance and licensed under the terms of the GNU General Public License, Version 2, or the GNU Lesser General Public License, Version 2.1, on a data carrier (CD-ROM, DVD or USB stick). Please contact us via e-mail ([info@miele.com](mailto:info@miele.com)) or the below postal address and state the product name, the serial number and the date of purchase to obtain this source code.

Miele & Cie. KG  
Open Source  
GTZ/TIM  
Carl-Miele-Straße 29  
33332 Gütersloh

Please note the limited warranty in favor of the rights holders under the terms of the GNU General Public License, Version 2, and the GNU Lesser General Public License, Version 2.1:

*This program is distributed in the hope that it will be useful, but WITHOUT ANY WARRANTY, without even the implied warranty of MERCHANTABILITY of FITNESS FOR A PARTICULAR PURPOSE. See the GNU General Public License and GNU Lesser General Public License for more details.*

## Copyrights and licenses for the communication module

---

For the purpose of operating and controlling the communication module, Miele uses proprietary or third-party software that is not covered by open source licensing terms. This software/ these software components are protected by copyright. The copyrights held by Miele and third parties must be respected.

This communication module contains software components which are distributed under open source license conditions. The open source components contained in the appliance along with the corresponding copyright notices, copies of the licensing terms valid at the time, and any additional information can be accessed locally via *http://<IP address>/Licenses*. The liability and warranty arrangements for the open source licenses displayed in this location only apply in relation to the respective rights holders.



Please have the model and serial number  
of your appliance available when  
contacting Customer Service.

---

## **U.S.A.**

**Miele, Inc.**

### **National Headquarters**

9 Independence Way  
Princeton, NJ 08540  
[www.mieleusa.com](http://www.mieleusa.com)

### **Customer Support**

Phone: 888-99-MIELE (64353)  
[info@mieleusa.com](mailto:info@mieleusa.com)

### **International Headquarters**

Miele & Cie. KG  
Carl-Miele-Straße 29  
33332 Gütersloh  
Germany

## **Canada**

**Importer**  
**Miele Limited**

### **Headquarters and Miele Centre**

161 Four Valley Drive  
Vaughan, ON L4K 4V8  
[www.miele.ca](http://www.miele.ca)

### **Customer Care Centre**

Phone: 1-800-565-6435  
905-532-2272  
[customercare@miele.ca](mailto:customercare@miele.ca)

H 7840 BM, H 7770 BM, H 7870 BM

en-US, CA

M.-Nr. 11 900 090 / 07