

GRS600AV

GE® 30" Slide-In Electric Convection Range with No Preheat Air Fry and EasyWash™ Oven Tray

Dimensions and Installation Information (in Inches)

Receptacle Locations: Locally approved flexible service cord or conduit must be used because terminals are not accessible after range installation. See shaded area in drawing for location of electrical outlet box. Recommended outlet locations allow range to be installed directly against rear wall.

Note: This appliance has been approved for 0" spacing to adjacent surfaces above the cooktop. However, a 6" minimum spacing to surfaces less than 15" above the cooktop and adjacent cabinet is recommended to reduce exposure to steam, grease splatter and heat.

Installation Information: Before installing, consult installation instructions for current dimensional data and additional requirements.

KW Rating	
240V	13.2
208V	9.9
Breaker Size	
240V	40 Amps†
208V	40 Amps†

†**Note:** Check local codes for required breaker size.

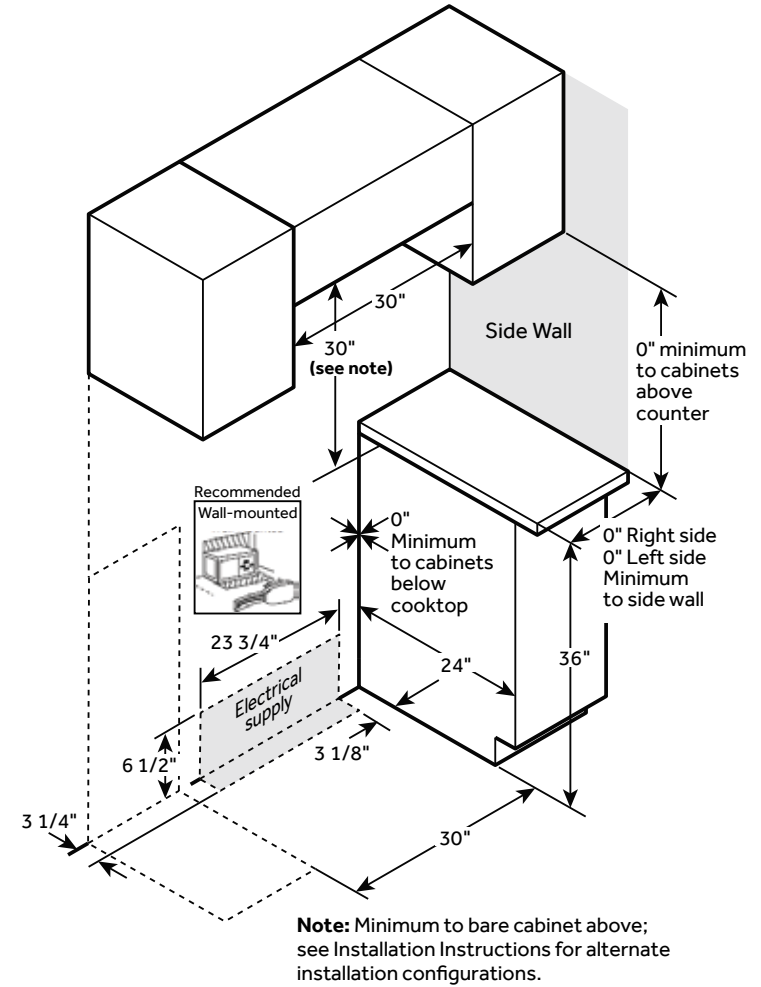
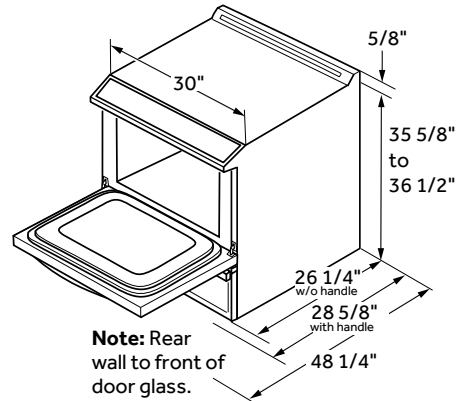

For answers to your Monogram, Café™, GE Profile™ or GE Appliances product questions, visit our website at geappliances.com or call GE Answer Center® Service, 800.626.2000.



All GE Appliances ranges are equipped with an Anti-Tip device. The installation of this device is an important, required step in the installation of the range.



GRS600AV

GE® 30" Slide-In Electric Convection Range with No Preheat Air Fry and EasyWash™ Oven Tray

Features and Benefits

EasyWash™ Oven Tray – Oven cleaning is easier than ever with the EasyWash™ Oven Tray. This enameled tray is easily removed and rinsed clean in the sink or, for bigger messes, guaranteed to fit in all GE Appliances dishwashers.

Built-In WiFi – Built-in WiFi and the SmartHQ™ app give you oven control functions like remote preheat, the ability to monitor and change oven temperature, turn off your oven and more!

No Preheat Air Fry – No preheat air frying is a great way to get crispier versions of your favorite foods in less time.

Slide-In Range – Easily upgrade your kitchen with this new slide-in range that is guaranteed to fit into your existing space.

No Preheat Fresh Reheat – This no preheat mode is USDA MyPlate-Certified and perfect for reheating healthy leftovers from the night before, the to-go box from your favorite restaurant or restoring foods to ideal crispiness, saving you time and delivering delicious results.

No Preheat Pizza – Specifically designed to cook your frozen pizza perfectly, this no preheat option is a time saver and a great way to get dinner on the table fast.

Express Preheat – Get food on the table quicker thanks to a fast preheat oven. In just 7 minutes*, you have a perfectly preheated oven. *Preheats oven in just 7 minutes, bake mode to preheat beep, 350 degrees, one standard rack.

9"/6" Power Boil™ Burner – Easily adjust to any size pot or pan with a convertible 6" and 9" element that makes it easy to boil water faster.

12"/9" Power Boil™ Burner – Use this Power Boil™ burner as a 12" or 9" element for rapid heat and flexibility on all sized cookware.

Convection – Cook and brown foods more evenly with convection cooking that uses a rear fan to circulate hot air.

Fifth Element Warming Zone – A convenient low-heat warming zone provides perfect temperature control for foods on the cooktop.

Steam Clean – Leave your EasyWash™ Oven Tray inside to use the steam clean oven function. Save time and effort by steam-cleaning the oven after use without the need for special water, kits, or extra steps.

Hidden Bake Element – Enjoy a clean and sleek interior that eliminates hard-to-reach areas thanks to a concealed oven element.

Oven Storage Drawer – This model features a removable oven storage drawer that offers the perfect place to store cookware and other kitchen accessories.

Model GRS600AVWW – White

Model GRS600AVES – Slate

Model GRS600AVFS – Fingerprint Resistant Stainless Steel

Model GRS600AVDS – Black Slate



Guaranteed Fit

Replace your old 30" free-standing range with a new 30" slide-in model. GE slide-in ranges are guaranteed for an exact fit or GE Appliances will pay up to \$300 toward modifications. Visit geappliances.com for more info.

