

## PROPANE CONVERSION INSTRUCTIONS

### ⚠️ WARNING Explosion Hazard

Death or serious injury can result from failure to follow these instructions.

- Service by a qualified service technician only.
- Shut off gas supply and disconnect power before servicing.
- Reconnect all grounding devices after service.
- Replace all parts and panels before operating.

### ⚠️ ADVERTENCIA Riesgo de Explosión

Se podrá producir la muerte o daños graves como resultado de no seguir estas instrucciones.

- El servicio técnico deberá ser realizado por un técnico calificado del servicio únicamente.
- Cierre el suministro de gas y desconecte la corriente antes de realizar el servicio técnico.
- Vuelva a conectar todos los dispositivos de conexión a tierra luego de realizar el servicio técnico.
- Vuelva a colocar todas las piezas y paneles antes del uso.

The pressure regulator and the burner orifices are set for natural gas. To use propane gas, the regulator and burner orifices must be converted.

If converting back to natural gas from propane, follow these instructions to convert the regulator, cooktop and oven burners, as well as cooktop low flame setting to the natural gas setup. The NG orifice table at the end of the instructions will aid in identifying the proper location for NG orifices.

**⚠️ WARNING** Do not operate the cooktop or oven burners of this range when using propane (bottled) gas before converting the pressure regulator and burner orifices for propane gas use. Failure to do so could cause high flames and toxic fumes which can result in serious injury.

**⚠️ ADVERTENCIA** No utilice la superficie de cocción ni los quemadores del horno de esta estufa al usar gas propano (embotellado) antes de convertir los orificios del regulador de presión y de los quemadores para uso con gas propano. Si no se cumple con esto, se podrán producir llamas altas y humos tóxicos que podrán ocasionar lesiones graves.

The propane (LP) orifices for the cooktop and oven burners are shipped in the literature package.

### NOTICE:

Save the propane (LP) kit with orifices and instructions for future conversions that may need to occur.

## TOOLS REQUIRED:

- Adjustable wrench
- Socket wrench with 1/2" socket and extension
- Phillips head screwdriver
- Torx driver: T20 (Some models only)
- Flat bladed screwdriver (blade approximately 3/32" across)
- Nut drivers: 1/4" and 9/32" or 7mm
- Masking tape

To adjust your range for use with propane gas, follow these instructions:

1. Disconnect all electrical power, at the main circuit breaker or fuse box.
2. Shut off the gas supply to the range by closing the manual shut-off valve.

## CONVERTING THE PRESSURE REGULATOR

The pressure regulator is located on the back of the unit in the lower, left-hand corner of the range as viewed from the back.

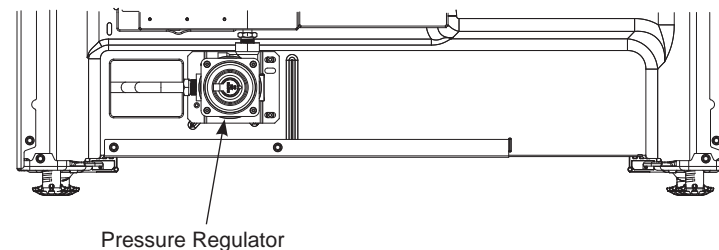

A. If this is your regulator:

1. Use an adjustable wrench to unscrew the hex-nut cap from the pressure regulator.
2. Completely remove the protective plastic cap off the threaded metal cap.

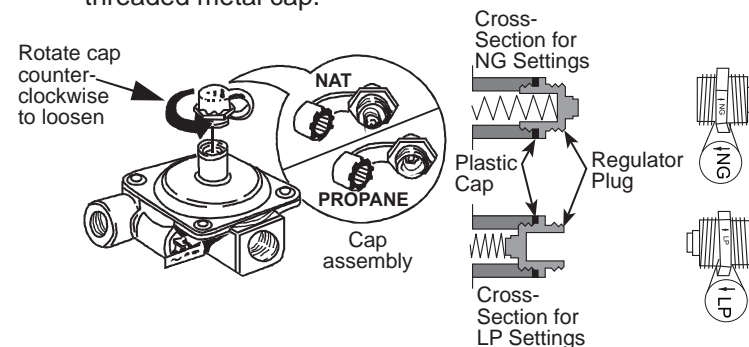

3. Turn the metal cap over and reinstall on regulator so the hollow end faces outward. Ensure plastic washer from cap is in between regulator and cap and LP label is pointing toward the regulator as shown.
4. Screw the hex-nut cap back into the regulator. **(Do not over tighten)**

B. If this is your regulator:

1. Use an adjustable wrench to unscrew the hex-nut cap from the pressure regulator.
2. Turn the plastic cap 1/4 turn to disassemble.

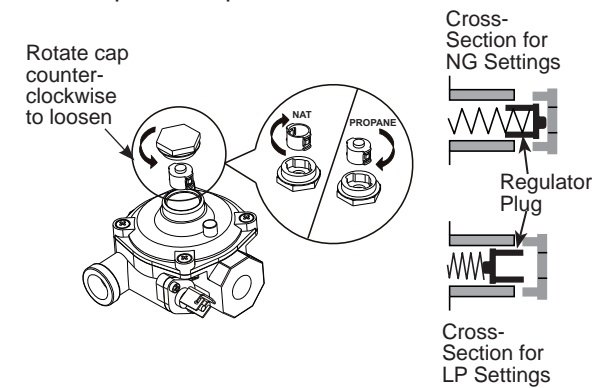

3. Turn the plastic cap over and hook it into the slots. Rotate cap 1/4 turn to reassemble. The type of gas to be used should now be visible on the top of the cap.
4. Screw the hex-nut cap back onto the pressure regulator.

## CONVERTING THE COOKTOP BURNERS

A. Remove the top grates, burner caps and burner heads.

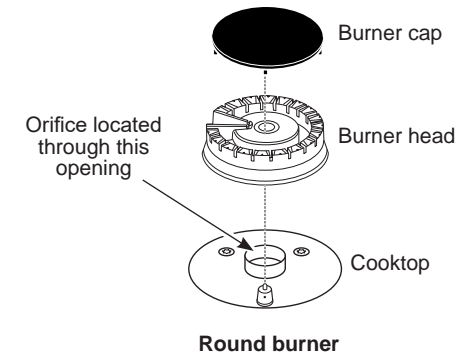

B. Use a 7mm or 9/32" nut driver to remove the top burner orifices by rotating the driver counterclockwise. Applying masking tape to the end of the nut driver will help hold the orifice in the driver when changing out the orifices. These orifices are accessed through the burner opening in the cooktop.

### NOTICE:

Save these orifices for future conversion back to natural gas.

C. Remove the propane orifices from the kit provided. The propane orifices have the letter "L" on the top. To aid in identifying the proper location for the propane orifices during conversion from Natural Gas to Propane Gas, color codes have been added to the side or top of the orifice. See the chart below.

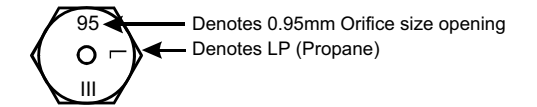

BURNER OUTPUT RATINGS: BTU/HR				
Propane Gas 10" W.C.P.				
BURNER	BTU RATE	ORIFICE SIZE (mm)	COLOR	MARKING
LF	15,000	1.14	Orange/Silver	114L
LR	5,000	0.66	Red/Yellow	66L
RF	9,500	0.92	Orange/Light Blue	92L
RF*	15,000	1.14	Orange/Silver	114L
RR	9,500	0.92	Orange/Light Blue	92L
C	8,000	0.84	Brown/Green	84L
Broil*	5,500	0.69	None	069L
Bake	12,000	1.07	None	L042

\*For GGF600 and GGS600 models

D. Using a 7mm or 9/32" nut driver, install the propane (LP) orifices in their precise locations

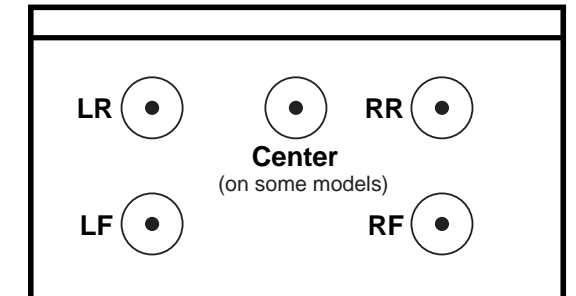

To prevent leakage, make sure the orifice spuds are securely screwed into the gas supply tubes.

- E. Reassemble the cooktop burners with the burners sitting level on the cooktop and the caps flat on the burner. Ensure burner cap pins are not in the stability chamber of the burner (wedge shaped opening).
- F. Place the old orifice spuds into the kit bag along with these instructions, and keep kit with literature package for possible future conversion.

## CHECK SURFACE BURNERS

Push and turn a knob to the LITE position. A clicking sound indicates proper operation of the ignition system. When lighting any burner, sparks will appear at all burners but gas flows from only the one selected. Once air is purged from the supply line, burner should light within 4 seconds. After burner lights, rotate the knob out of the LITE position. Try each burner in succession until all burners have been checked.

### Quality of Flames

Determine the quality of flames visually. Normal burner flames should look like (A) or (B).

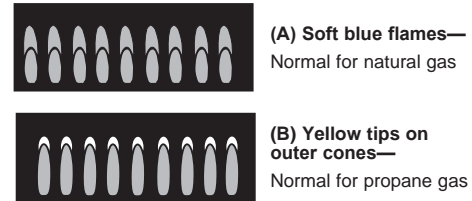

Long, bright yellow flames are not normal. Normal flames may show signs of an orange tint when well heated or signs of flickering orange due to particles in the gas or air.

## ADJUSTING LOW FLAME SETTING ON COOKTOP BURNERS

Low flow settings are set for Natural Gas and should be adjusted for Propane (LP) per the instructions below.

Low setting adjustments must be made with other burners in operation on a medium setting. This procedure prevents the low flame from being set too low, resulting in the flame being extinguished when other burners are turned on.

A. Turn on all surface burners to medium setting.

B. Turn the knob on the burner being adjusted to “LO”.

C. Remove the knob and insert a small, flat blade screwdriver into the valve shaft as shown. Turn clockwise as far as possible while maintaining a stable flame. Repeat for all valves.

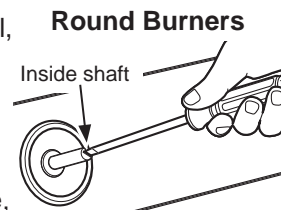

D. If flame appears too low or unstable, slowly turn adjustment screw counterclockwise until a stable flame exists for each burner.

E. Additionally, for each burner being adjusted, quickly open and close the oven door while observing the flame. If flame is extinguished, turn adjustment screw counterclockwise for a larger flame. Repeat door openings until flame is stable.

## CONVERTING THE OVEN BURNERS

### NOTICE:

This product cannot be converted to propane by adjusting the oven orifices. The orifices must be replaced for propane.

### NOTICE:

Take special care not to damage the glow bar when removing the burner.

### BAKE BURNER ORIFICE

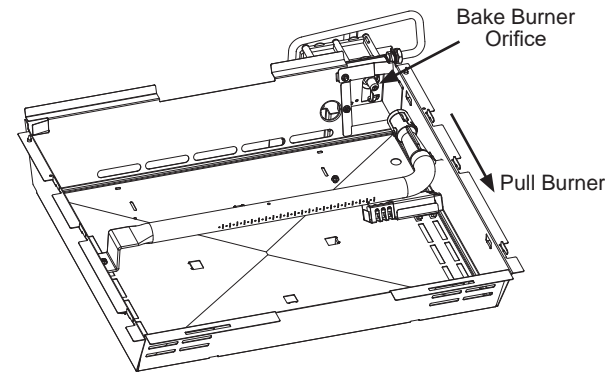

1. Remove oven racks, door and oven bottom. Some models may secure the oven bottom with a T20 screw in the front.
2. The bake burner orifice is on the gas valve located at the back of the cavity behind the burner. Remove the glowbar shield, flame spreader and bake burner by removing three 1/4" hex screws.
3. Lift the burner off the orifice and apply 1/2" socket on an extension to the hex base of the orifice. Loosen the orifice by turning counter-clockwise and remove.

### NOTICE:

Save these orifices for future conversion back to natural gas.

4. Select the propane bake orifice from the kit and install it on the gas valve. Tighten until snug. Replace bake burner and secure with screw.

### BROIL BURNER ORIFICE (On models equipped with a gas broil burner)

1. Remove the 1/4" hex screw securing the broil burner and allow it to hang down free of the broil orifice.
2. Apply a 1/2" wrench to the hex base of the orifice. Loosen the orifice by turning counter-clockwise and remove.
3. Select the propane broil orifice from the kit and install it on the broil elbow. Tighten until snug.
4. Replace the broil burner over the orifice and replace the screw securing the burner.

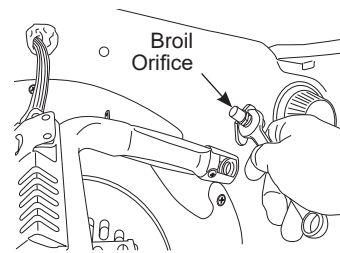

## CHECK OVEN BURNERS

The air shutter should not have to be adjusted when converting the unit unless there is an unusual flame observation from the directions below. The following table can be used for reference.

BURNER	AIR SHUTTER SETTING FOR PROPANE	AIR SHUTTER SETTING FOR NG
Bake	0.350"	0.350"
Broil	0.250"	0.250"

Oven burner flame must be observed with the oven bottom and flame spreader removed and the door closed to properly check flame characteristics

1. As you watch the flame with the oven door closed, check the following through the oven door window.
  - a. For Natural Gas, if the flames are yellow, open the air shutter more.
  - b. If the flames blow away or flutter from the burner, close the air shutter slightly.
2. Turn bake burner off. (On some models) Repeat with broil burner.

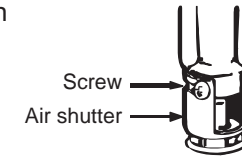

### ⚠ WARNING

If you attempt to measure the inner cone of the flame, please use caution: burns could result.

### ⚠ ADVERTENCIA

Si intenta medir el cono interno de la llama, por favor tenga cuidado: se podrán producir quemaduras.

3. Checking the flame size:

It should be approximately 1/2" to 3/4" long for the bake and broil burners.

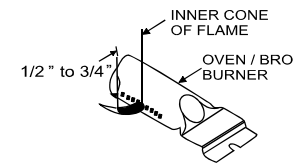

The combustion quality of the burner flames needs to be determined visually.

**NOTE: If burner flames look like (A), further air shutter adjustment to the bake burner is required. Normal burner flames should look like (B) or (C), depending on the type of gas you use. With propane gas, some yellow tipping on the outer cones is normal.**

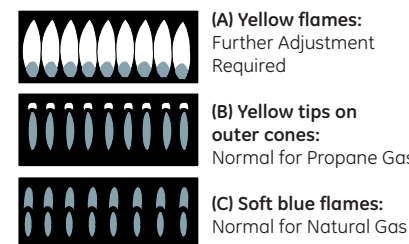

Foreign particles in the gas line may cause an orange flame at first, but this will soon disappear.

4. When all adjustments are made, and the results are satisfactory:
  - a. Retighten the air shutter screws.
  - b. Ensure burner is screwed down and glow bar position has not moved.
  - c. Replace the glowbar shield and flame spreader.
  - d. Replace the oven bottom.

### NOTICE:

Once the conversion is complete and confirmed, fill out the propane sticker and include your name, organization and date conversion was made. Apply the sticker to the range near the regulator to alert others in the future that this appliance has been converted to propane. If converting back to natural gas from propane, please remove the sticker so others know the appliance is set to use natural gas.

## ADDITIONAL INFORMATION

### BURNER OUTPUT RATINGS: BTU/HR

NG (Natural) Gas 5" W.C.P.

BURNER	BTU RATE	ORIFICE SIZE (mm)	COLOR	MARKING
LF	15,000	1.78	Brown	178N
LF**	18,000	1.98	Purple	198N
LR	5,000	1.01	White/Purple	101N
RF	9,500	1.36	Green	136N
RF*	15,000	1.78	Brown	178N
RR	9,500	1.36	Green	136N
C	8,000	1.26	None	126N
Broil*	6,000	1.07	None	107N
Bake	14,000	1.65	None	1.65

\* For GE GGF600 and GGS600

\*\*For GE GGS600

