

FRIGIDAIRE

GALLERY



30" Front Control Electric Range with Total Convection

Electric Range

Available Products: GCFE3060BD, GCFE3060BF

Available Colors: Black Stainless Steel, Stainless Steel

Version: 04/23

Product Specifications

Cooktop

Bridge Element	Yes
Bridge Element Location	Left
Cooking Surface Type	Smooth
Element On Indicator Light	Yes
Hot-Surface Indicator Light	Yes

Cooktop Performance

Right Front Element Burner Size	9"
Right Rear Element Burner Size	6"
Left Front Element Burner Size	7"
Left Rear Element Burner Size	7"
Right Front Element Burner	3,200 Watts
Right Rear Element Burner	1,200 Watts
Left Front Element Burner	1,800 Watts
Left Rear Element Burner	1,800 Watts
Center Rear Element Burner	100 Watts
Keep Warm Burner Location	Center Rear

Cooking Controls Function

Change between Continuous Bake Setting or 12-Hour Energy Saving Feature	Yes
Delayed Bake	Yes
Program Fahrenheit or Celsius	Yes
Silent Control Panel	Yes

Drawer

Drawer Handle Style	Integrated
Drawer Type	Storage

Display

Control Location	Front
Display Interface Color	White
Display Type	Capacitive Touch

Dimensions and Volume

Minimum Height	35 3/8"
Maximum Height	36 3/8"
Width	30"
Depth	26"
Depth With Door 90° Open	47 5/16"
Depth With Handle	28 1/2"
Oven Interior Height	21 1/4"
Oven Interior Width	25 3/16"
Oven Interior Depth	19 7/8"
Oven Capacity	6.2 Cu. Ft.

Installation

Adjustable Leveling Legs	Yes
--------------------------	-----

For planning purposes only. We reserve the right to change specifications or discontinue models without notice. Refer to Product Installation Guide for detailed installation instructions on the web at [frigidaire.com / frigidaire.ca](http://frigidaire.com/frigidaire.ca) Electrolux Major Appliances, N.A.

USA • 10200 David Taylor Drive • Charlotte, NC 28262 • Charlotte, NC 28262 • 1-877-4electrolux (1-877-435-3287) • frigidaire.com
CANADA • 5855 Terry Fox Way • Mississauga, ON L5V 3E4 • 1-800-265-8352 • frigidaire.ca

Cooking Controls

Air Fry	Yes
Air Sous Vide	Yes
Bake	Yes
Bake Time	Yes
Bread Proof	Yes
Broil	Yes
Clock	Yes
Convection Bake	Yes
Convection Convert	Yes
Convection Roast	Yes
Cook Time	Yes
Cooktop Lockout	Yes
Dehydrate	Yes
Delay Clean	Yes
Delay Start	Yes
Door Lock	Yes
Hot Surface	Yes
Keep Warm	Yes
Kitchen Timer	Yes
Light	Yes
Lockout	Yes
Multi-Stage Cooking	Yes
My Favorite	Yes
No Preheat	Yes
Off	Yes
On / Off (for each element)	Yes
Oven Indicator Light	Yes
Oven Light	Yes
Oven Lock	Yes
Perfect Turkey	Yes
Preheat	Yes
Probe	Yes
Self Clean	Yes
Set Clock	Yes
Slow Cook	Yes
Start	Yes
Start Time	Yes
Steam Bake	Yes
Steam Clean	Yes
Steam Roast	Yes
Temperature Display	Yes
Timer On / Off	Yes
User Preferences	Yes

Oven

Bake Element	2,600 Watts
Bake Element Pass	4
Bake Element Type	Hidden
Broil Element	4,000 Watts
Broil Element Pass	6
Cleaning System	Yes
Convection	Yes
Convection Element	3,800 Watts
Convection Type	Total
Number of Convection Fans	1
Number of Rack Positions	8
Oven Interior Color	Midnight Black
Oven Light Quantity	2
Oven Light Type	Halogen
Oven Light Watts	40 Watts
Rack Position Type	Embossed
Rack Type 1	Flat
Rack Type 1 Quantity	2

Certifications and Approvals

ADA Compliant	Yes
Star-K Certification	Yes

Controls

Control Lock	Yes
Sabbath Mode	Yes

Exterior

Backlit Knobs	Yes
---------------	-----

Electrical Specifications

Connected Load @ 240V	13 kW
Minimum Circuit Required	40 Amps
Voltage Rating	240 V

General Specifications

Frigidaire Fit Promise	Yes
Prop 65 Label	Yes
Warranty - Labor	1 Year
Warranty - Parts	1 Year

Safety Certifications and Approvals

UL Listed	Yes
RoHS	Yes

Installation Diagram

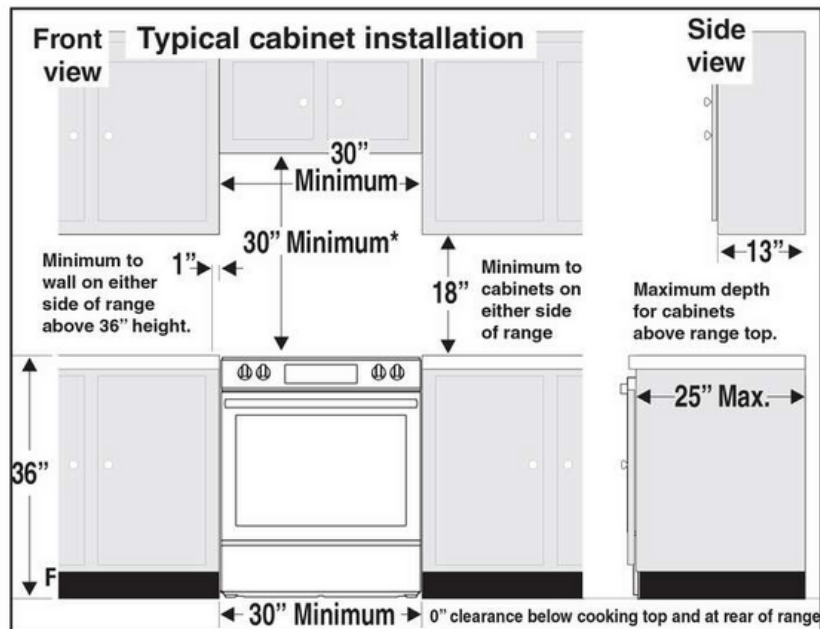

Fig. 1

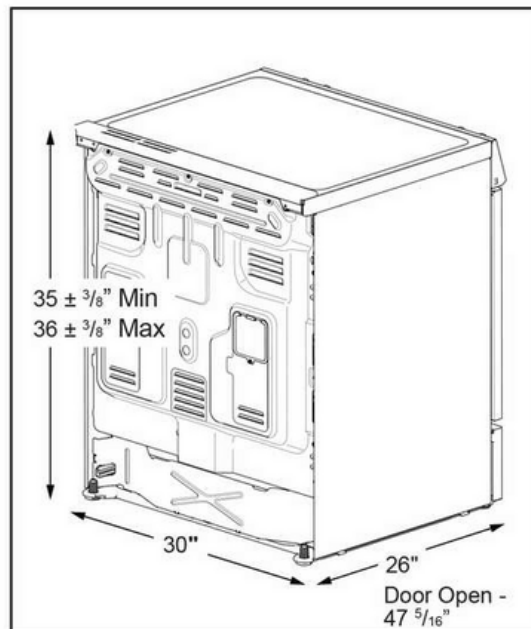

Fig. 2

*30" (762 mm) MINIMUM CLEARANCE BETWEEN THE TOP OF THE COOKING SURFACE AND THE BOTTOM OF AN UNPROTECTED WOOD OR METAL CABINET; OR 24" (610 mm) MINIMUM WHEN BOTTOM OF WOOD OR METAL CABINET IS PROTECTED BY NOT LESS THAN 1/4" (6 mm) FLAME RETARDANT MILLBOARD COVERED WITH NOT LESS THAN NO. 28 MSG SHEET STEEL, 0.015" (0.4 mm) STAINLESS STEEL, 0.024" (0.6 mm) ALUMINUM OR 0.020" (0.5 mm) COPPER. 0" (0 mm) CLEARANCE IS THE MINIMUM FOR THE REAR OF THE RANGE. FOLLOW ALL DIMENSION REQUIREMENTS PROVIDED ABOVE TO PREVENT PROPERTY DAMAGE, POTENTIAL FIRE HAZARD, AND INCORRECT COUNTERTOP AND CABINET CUTS.

TO ELIMINATE THE RISK OF BURNS OR FIRE BY REACHING OVER HEATED SURFACE UNITS, CABINET STORAGE SPACE LOCATED ABOVE THE SURFACE UNITS SHOULD BE AVOIDED. IF CABINET STORAGE IS TO BE PROVIDED, THE RISK CAN BE REDUCED BY INSTALLING A RANGE HOOD THAT PROJECTS HORIZONTALLY A MINIMUM OF 5" (127 mm) BEYOND THE BOTTOM OF THE CABINETS.

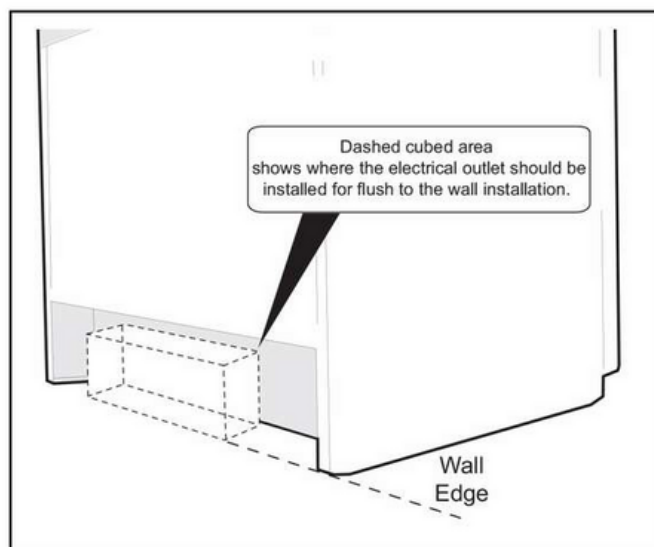

Fig. 3