

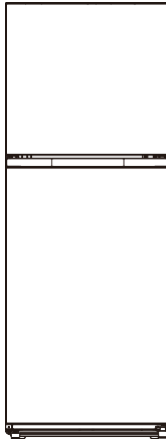

TWO-DOOR REFRIGERATOR WITH TOP FREEZER



Models: FF1142PL

User Manual

BEFORE USE, PLEASE READ AND FOLLOW ALL SAFETY RULES AND OPERATING INSTRUCTIONS.

Write Model and Serial Numbers here:

Model No.: _____

Serial No.: _____

**Felix Storch, Inc.
An ISO 9001:2015 registered
company
770 Garrison Ave
Bronx, New York 10474
www.summitappliance.com**

Contents

Safety information and warnings	2	Cleaning and care	15
Installing your new appliance	7	Helpful tips	17
Description of the appliance	12	Troubleshooting	19
Control Panel	13	Disposal of the appliance	20
Using your appliance	14		



Safety information and warnings

For your safety and correct usage, before installing and first using the appliance, read this user manual carefully, including its hints and warnings. To avoid unnecessary mistakes and accidents, it is important to make sure that all people using the appliance are thoroughly familiar with its operation and safety features. Save these instructions and be sure that they remain with the appliance if it is moved or sold, so that anyone using it throughout its life, will be properly informed on its usage and safety notices.

Safety for children and others who are vulnerable people

This appliance can be used by children aged from 8 years and above and persons with reduced physical, sensory, or mental capabilities or lack of experience and knowledge if they have been given supervision or instruction concerning the use of the appliance in a safe way and understand the hazards involved. Children shall not play with the appliance. Cleaning and user maintenance shall not be made by children without supervision.

This appliance is not intended for use by persons (including children) with reduced physical, sensory, or mental capabilities, or lack of experience and knowledge unless they have been given supervision or instruction concerning the use of the appliance by a person being responsible for their safety. Children should be supervised to ensure that they do not play with the appliance.

- Keep all packaging away from children as there is the risk of suffocation.
- If you are discarding the appliance, pull the plug out of the socket, cut the connection cable (as close to the appliance as you can), and remove the door to prevent children playing from suffering an electric shock or from closing themselves inside it.
- If this appliance, featuring a magnetic door seal, is to replace an older appliance having a spring lock (latch) on the door or lid, be sure to make the spring lock unusable before you discard the old appliance. This will prevent it from becoming a death trap for a child.

GENERAL SAFETY



- **WARNING** —This appliance is intended to be used in household and similar applications such as
 - staff kitchen areas in shops, offices, and other working environments.
 - farmhouses and hotels, motels, and other residential-type environments.
 - bed and breakfast type environments.
 - catering and similar non-retail applications.
- **WARNING** — Do not store explosive substances such as aerosol cans with a flammable propellant in this appliance.
- **WARNING** — If the supply cord is damaged, it must be replaced by the manufacturer, its service agent, Refrigerants, or similarly qualified persons in order to avoid a hazard.
- **WARNING** — Keep ventilation openings, in the appliance enclosure or in the built-in structure, clear of obstruction.
- **WARNING** — Do not use mechanical devices or other means to accelerate the defrosting process, other than those recommended by the manufacturer.
- **WARNING** — Do not damage the refrigerant circuit.
- **WARNING** — Do not use extension cords or ungrounded (two-prong) adapters.
- **WARNING**- This appliance is CFC- and HFC-free and contains small quantities of Isobutane (R600a) which is environmentally friendly, but flammable. It does not damage the ozone layer, nor does it increase the greenhouse effect. Care must be taken during transportation and setting up of the appliance so that no parts of the cooling system are damaged. Leaking coolant can ignite and may damage the eyes.
- In the event of any damage:
 - Avoid open flames and anything which creates a spark,
 - Disconnect from the power supply,
 - Air the room in which the appliance is located for several minutes and
 - Contact the Service Department for advice.
- The more coolant there is in an appliance, the larger the room it should be installed in. In the event of a leakage, if the appliance is in a small room, there is the danger of combustible gases building up.
- For every ounce of coolant at least 325 cubic feet of room space is required. The amount of coolant in the appliance is stated on the data plate inside the appliance. It is hazardous for anyone other than an Authorized Service Person to carry out servicing or repairs to this appliance.
- Take serious care when handling, moving, and using the appliance to avoid either damaging the refrigerant tubing or increasing the risk of a leak.
 - Replacing component parts and servicing shall be done by factory-authorized service personnel, so as to minimize the risk of possible ignition due to incorrect parts or improper service.
 - **WARNING** — Do not use electrical appliances inside the food storage compartments of the appliance, unless they are of the type recommended by the manufacturer.

- **WARNING** — The refrigerant and insulation blowing gas are flammable. When disposing of the appliance, do so only at an authorized waste disposal center. Do not expose to flame.
- **WARNING** —When positioning the appliance, ensure the supply cord is not trapped or damaged.
- **WARNING** —Do not place multiple portable outlets or portable power supplies at the rear of the appliance.

Refrigerant

The refrigerant isobutene (R600a) is contained within the refrigerant circuit of the appliance, a natural gas with a high level of environmental compatibility, which is nevertheless **flammable**. During transportation and installation of the appliance, ensure that none of the components of the refrigerant circuit are damaged.

WARNING — Refrigerators contain refrigerant and gases in the insulation. Refrigerant and gases must be disposed of professionally as they may cause eye injuries or ignition. Ensure that the tubing of the refrigerant circuit is not damaged prior to proper disposal.

It is hazardous for anyone other than an Authorized Service Person to service this appliance.



Caution: Risk of fire

-Do not store products that contain flammable propellants (e.g., spray cans) or explosive substances in the appliances.

Should the refrigerant circuit be damaged:

- Avoid open flames (candles, lamps, etc.,) and other sources of ignition.
- Thoroughly ventilate the room in which the appliance is situated.



Electrical safety

1. The power cord must not be lengthened.
2. Make sure that the power plug is not crushed or damaged. A crushed or damaged power plug may overheat and cause a fire.
3. Make sure that you can access the main plug of the appliance.
4. Do not pull the main cable.
5. If the power plug socket is loose, do not insert the power plug. There is a risk of electric shock or fire.
6. You must not operate the appliance without the interior lighting lamp cover.
7. The refrigerator must be connected to a power supply of single-phase alternating current of 110~115V/60Hz. If a fluctuation in voltage in the user's district is so large that the voltage exceeds the above scope, for safety's sake, be sure to apply an A.C. Automatic voltage regulator of more than 350W to the refrigerator. The refrigerator must be plugged into a special power outlet instead of a common one with other electric appliances. Its plug must match the socket with a grounded wire.

Daily use

- Do not store flammable gas or liquids in the appliance, there is a risk of an explosion.
- Do not operate any electrical appliances in the appliance (e.g., electric ice cream makers, mixers etc.).
- When unplugging always pull the plug from the mains socket, do not pull on the cable.
- Do not place hot items near the plastic components of this appliance.
- Do not place food products directly against the air outlet on the rear wall.
- Store pre-packed frozen food in accordance with the frozen food manufacturer's instructions.
- The appliance manufacturers' storage recommendations should be strictly adhered to. Refer to relevant instructions for storage.
- Do not place carbonated or fizzy drinks in the freezer compartment as it creates pressure on the container, which may cause it to explode, resulting in damage to the appliance.
- Frozen food can cause frost burns if consumed straight from the freezer compartment.
- Do not place the appliance in direct sunlight.
- Keep burning candles, lamps, and other items with bare flames away from the appliance so that do not set the appliance on fire.
- The appliance is intended for keeping food stuff and/or beverages in normal households as explained in this instruction booklet. You should take care when moving it as the appliance is heavy.
- Do not remove nor touch items from the freezer compartment if your hands are damp/wet, as this could cause skin abrasions or frost/freezer burns.
- Never use the base, drawers, doors, etc. to stand on or as supports.
- Frozen food must not be refrozen once it has been thawed out.
- Do not consume ice popsicles or ice cubes straight from the freezer as this can cause freezer burn to the mouth and lips.
- To avoid items falling and causing injury or damage to the appliance, do not overload the door racks or put too much food in the crisper drawers.



Warning

- To Risk of child entrapment. Before you throw away your old refrigerator or freezer:
- Take off the doors.
- Leave the shelves in place so that children cannot easily climb inside.

Care and cleaning

- Before maintenance, switch off the appliance and disconnect the mains plug from the mains socket.
- Do not clean the appliance with metal objects, steam cleaners, ethereal oils, organic solvents, or abrasive cleansers.
- Do use a plastic scraper instead of a sharp object to remove frost from the appliance.

Installation — Important!

- For the electrical connection, carefully follow the instructions given in

this manual. Unpack the appliance and check if there are damages to it.

- Do not connect the appliance if it is damaged. Report possible damages immediately to the place you bought it. In this case, retain packing.
- It is advisable to wait at least four hours before connecting the appliance to allow the oil to flow back into the compressor.
- Adequate air circulation should be around the appliance, a lack of circulation leads to overheating. To achieve sufficient ventilation, follow the instructions relevant to installation.
- Wherever possible the back of the product should not be too close to a wall to prevent the risk of a fire, follow the instructions relevant to installation.
- The appliance must not be located close to radiators or cookers.
- Make sure that the power plug is accessible after the installation of the appliance.

Service

- Any electrical work required to do the servicing of the appliance should be carried out by a qualified electrician or competent person.
- This product must be serviced by an authorized Service Center, and only genuine spare parts must be used.

NOTE: Children aged from 3 to 8 years are allowed to load and unload refrigerating appliances.

CALIFORNIA CARB/SNAP DISCLOSURE

This product uses eco-friendly hydrocarbon refrigerant and fully complies with California CARB regulations.

However, we are required by California Law to provide the following disclosure statement in every product sold in California.

"This equipment is prohibited from use in California with any refrigerants on the 'List of Prohibited Substances' for that specific end-use, in accordance with California Code of Regulations, title 17, section 95374. This disclosure statement has been reviewed and approved by Felix Storch, Inc. and Felix Storch, Inc. attests, under penalty of perjury, that these statements are true and accurate."

This product does **not** use any refrigerants on the 'List of Prohibited Substances'"

Installing your new appliance

Before using the appliance for the first time, read the following:

WARNING!

For proper installation, this refrigerator must be placed on a level surface of hard material that is the same height as the rest of the flooring. This surface should be strong enough to support a fully loaded refrigerator.

The rollers, which are not castors, should be only used for forward or backward movement.

Moving the refrigerator sideways may damage your floor and the rollers.

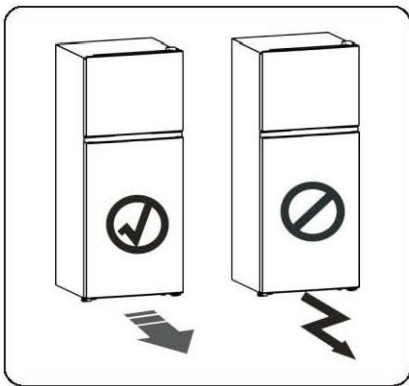

Ventilation of appliance

In order to improve the efficiency of the cooling system and save energy, it is necessary to maintain good ventilation around the appliance for the dissipation of heat. For this reason, sufficient clear space should be available around the refrigerator.

NOTE: It is recommended that there be 50mm of space from the back to the wall, at least 100mm from its top, at least 50mm from its side to the wall, and a clear space in front to allow the doors to open 125°. As shown in the following diagrams.

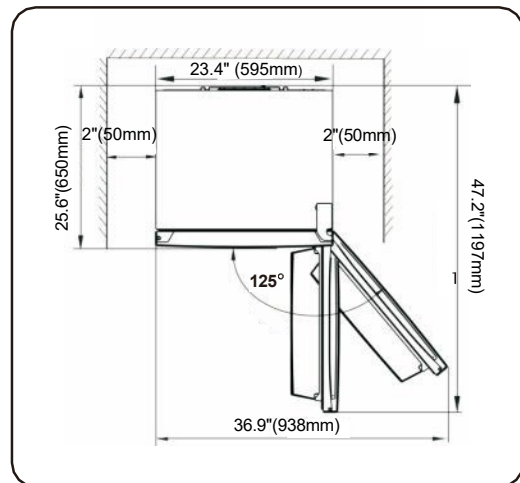
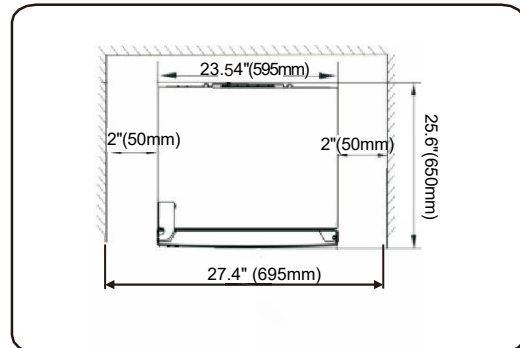
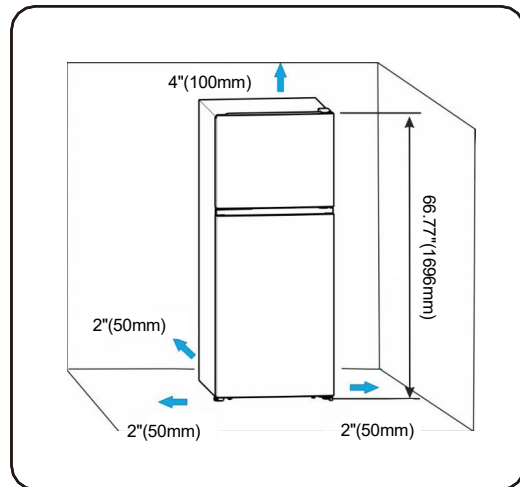

NOTE:

- This appliance performs well within the climate class from SN to T as shown in the table below. It may not work properly if left at a temperature above or below the indicated range for a long period.

Climate class	Ambient temperature
SN	+10°C to +32°C
N	+16°C to +32°C
ST	+16°C to +38°C
T	+16°C to +43°C



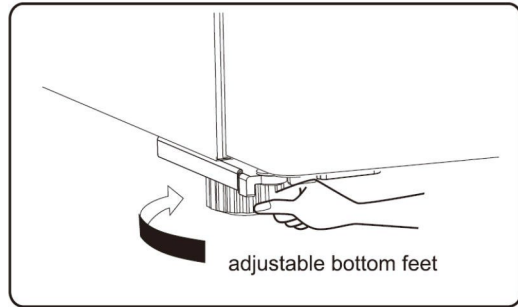
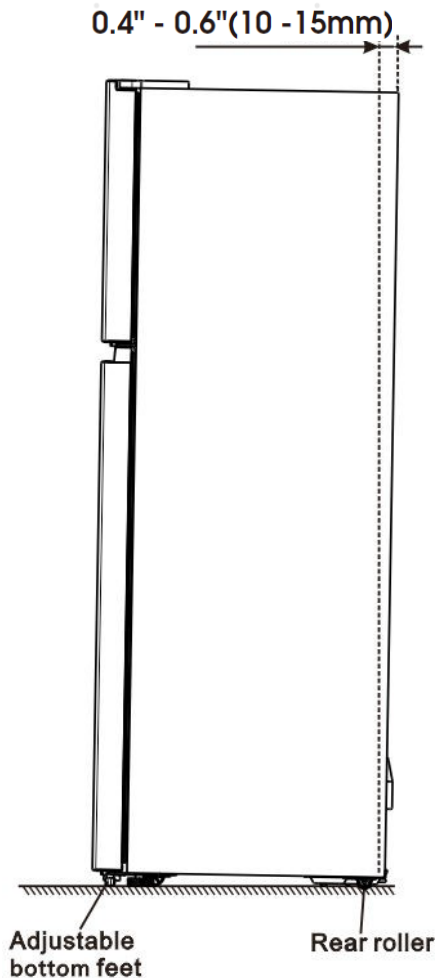

- Install your appliance in a dry place to avoid a high amount of moisture.
- Keep the appliance out of direct sunlight, rain, or frost. Keep the appliance away from heat sources such as stoves, fires, or heaters.

Leveling the appliance

- For appropriate leveling and air circulation in the lower rear section of the appliance, the bottom feet may need to be adjusted. You can adjust them manually by hand or by using a suitable spanner.
- To allow the doors to self-close, tilt the top backward by 10-15mm.

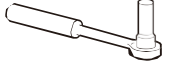
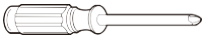

Tools you will need

	
8mm socket wrench	Cross-shaped screwdriver
	
Thin-blade screwdriver	Monkey wrench
	
	8mm wrench

Note: Before you start lay the refrigerator on its back in order to gain access to the base, you should rest it on soft foam packaging or similar material to avoid damaging the backboard of the refrigerator.

Reversing the door

The side at which the door opens can be changed, from the right side (as supplied) to the left side, if the installation site requires it.

Warning! When reversing the door, the appliance must not be connected to the electrical grid. Ensure that the plug is removed from the outlet.

1. Stand the refrigerator upright.

Open the upper door to take out all door racks (to avoid rack damage) and then close the door.

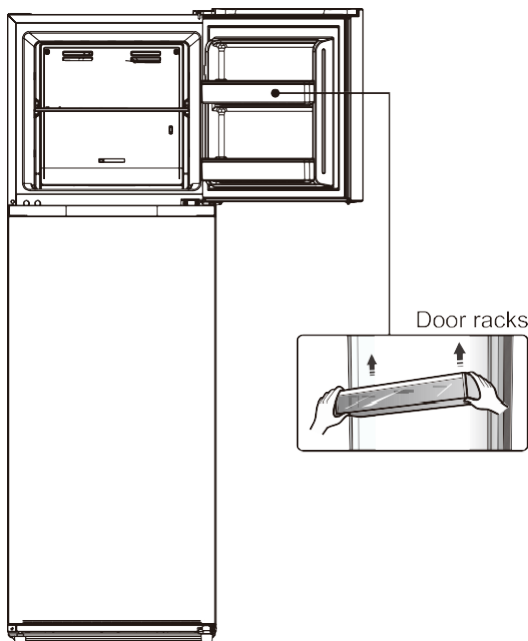

2. Stand the refrigerator upright, first remove the screw cover ① and loosen the screw ② and unscrew the upper hinge over ③ which is at the top right corner of the refrigerator, and use a putty knife or thin-blade screwdriver to prize the screw hole cover ④ which is at the top left corner of the refrigerator.

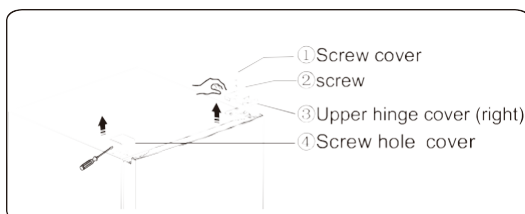

3. Unscrew the flange screws ① which are used for fixing the right upper hinge part ②. Lift the upper door and place it on a padded surface to prevent it from scratching.

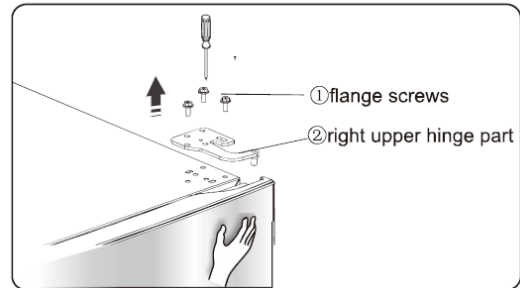

Note: Please hold the upper door by hand during step 3 to prevent door dropping.

4. Remove the upper door and place it on a smooth surface with the panel facing upwards. Loosen the screws ②, detach part ①, then screw in part ① on the left side.

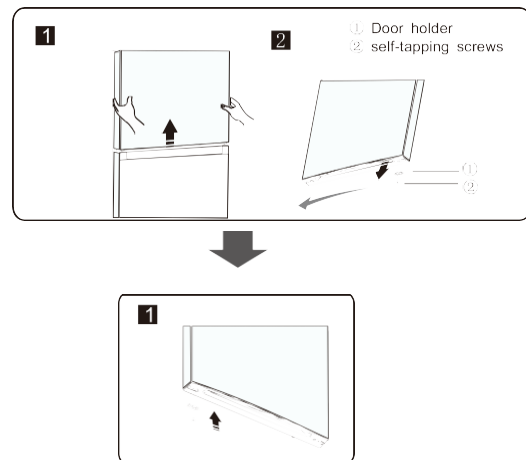

5. Loosen the screws used to hold the middle hinge and remove the middle hinge. Then, remove the lower door.

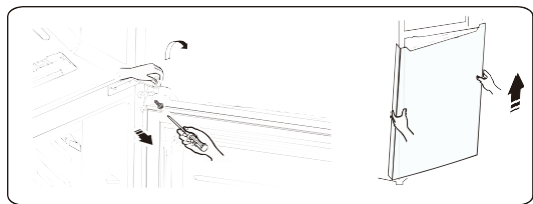

6. Place the lower door on a smooth surface with its panel upwards. Loosen screws ②, and detach part ①. Then install part ① to the corresponding position on the left side together with screws ②.

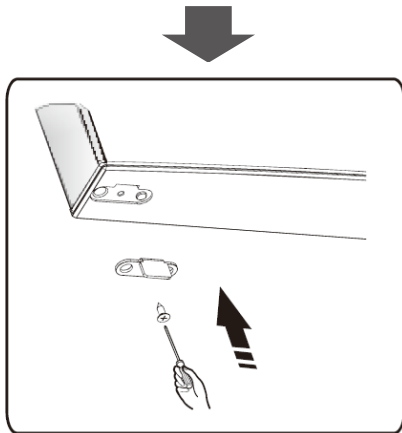
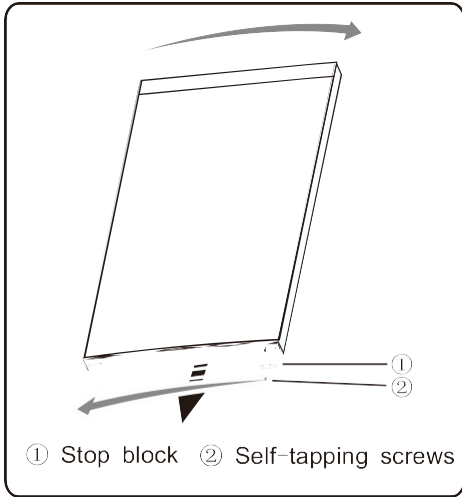

7. Change screw hole covers on middle cover plate from left to right (as shown in figure below).

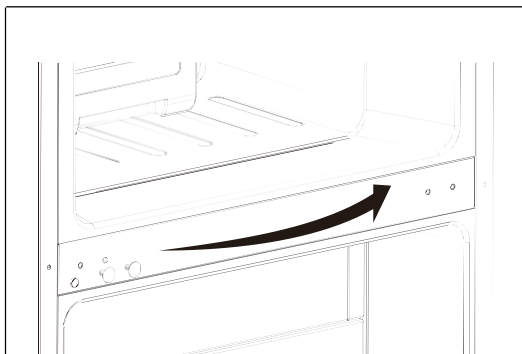

8. Place refrigerator flatwise, remove Part ③ and then loose screws ④. Remove part ② and part ①.

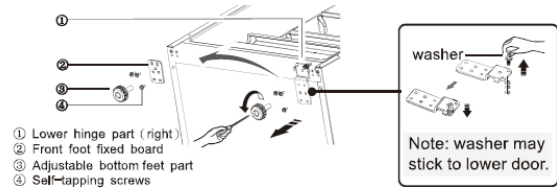

9. Screw out lower hinge, change it to the near hole site, and then screw up and mount washer.

10. Remount it as shown in step 8, move part ① and part ② to the right, and then affix them with screws ④. Finally, install part ③.

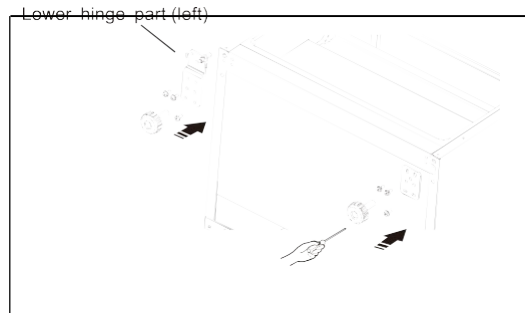

11. Move the lower door and adjust its position to align the lower hole and upper hinge axis. Turn the middle hinge by 180, move the washer on the axis to the upper side, adjust the middle hinge to the appropriate position, and then install it.

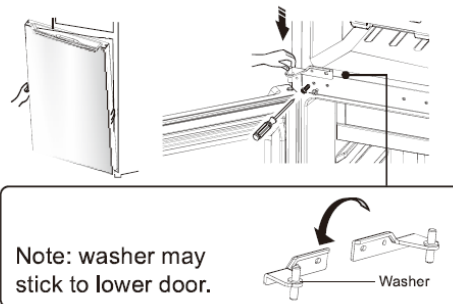

12. Unscrew the upper hinge axis, turn the upper hinge over, and affix the axis to it. Then place it on the side for use.

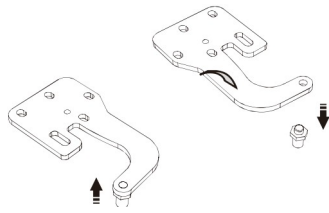

13. If reinstalled correctly, it should look similar to step 2. Move the upper hinge cover ③ to the left and affix it with screws ② and then install the screw cover ①. Finally, move the screw hole cover ④ to the right.

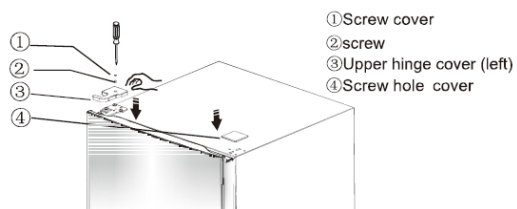

14. Open the upper door, mount the door racks and then close it.

Description of the appliance

Location of Parts

1. Freezer vents
2. Freezer shelf
3. Freezer temperature control
4. Refrigerator vents
5. Refrigerator temperature control
6. Refrigerator shelf
7. Crisper cover
8. Crisper
9. Adjustable bottom feet
10. Freezer door gasket
11. Freezer door
12. Freezer door rack
13. Refrigerator door gasket
14. Door switch
15. Upper door rack
16. Lower door rack
17. Refrigerator door

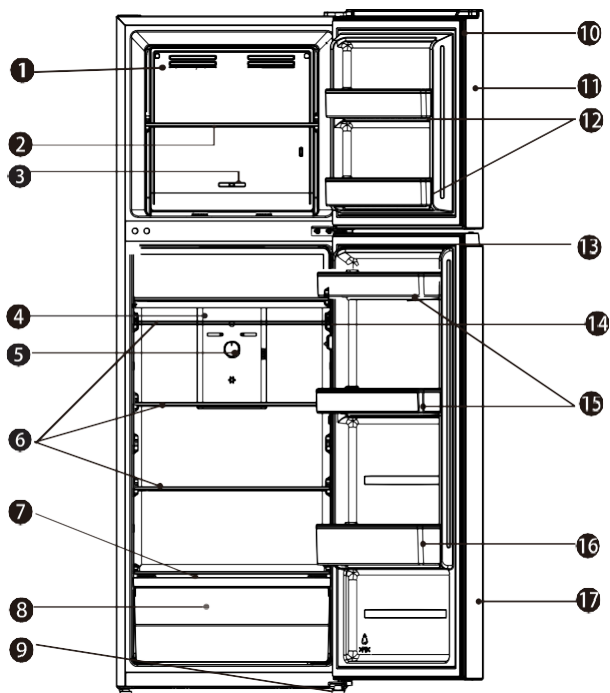







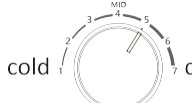

Note !

- Due to our commitment to continuous product improvement, all specifications are subject to change without notice.
- To get the best energy efficiency out of this product, please place all shelves, drawers, and baskets in their intended position as shown in the illustration above.

Control panel

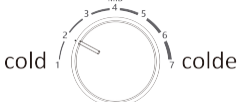
Please read the recommended temperature settings below. The temperature of the compartments inside the refrigerator can be adjusted by using the control panel. Use the refrigerator as you normally would and set the regulator in the middle position.

Temperature Setting Recommendation		
Condition	Freezer compartment	Refrigeration compartment
Summer (Higher than 90°F)	 <p>Set the temperature at approx. 1/4 from the left, set in the middle position to make the ice</p>	 <p>Set on 5~6</p>
Normal	 <p>Set the temperature to the halfway mark.</p>	 <p>Set on the middle position</p>
Winter (Under 54°F)	 <p>Set the temperature at approx. 3/4 from the left.</p>	 <p>Set on 6~7</p>
Settings Not Recommended		
Compartment	Setting	Effect
Freezer		It may cause the freezer compartment temperature increases.
Freezer		It may cause the refrigeration compartment temperature increases
Refrigeration	 <p>Set on 1~2</p>	It may cause the freezer compartment temperature to increase.
Refrigeration	 <p>Set on 7</p>	It may lead to more energy consumption.

NOTE:

Do not place too much food directly against the air outlet of the temperature sensor in the refrigerator compartment, as it affects the sensor and the unit will not be able to operate correctly.

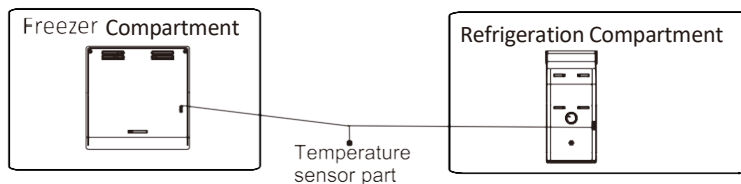

Using your appliance

Your appliance comes with the accessories shown in the **Location of Parts** section of this manual, this part of the manual will provide further information about them. We recommend that you read through it carefully before using the appliance

Door Rack

- It is suitable for the storage of eggs, canned liquid, bottled drinks, packed food, etc. Do not place too many heavy things on the racks.
- The small rack on the lower door can be placed at different heights according to your needs. Please take food out of the shelf before lifting vertically to reposition it.

Ensure that drink bottles are not left in the freezer for a longer time than recommended as freezing liquid may cause the bottle to break.

Shelf in Refrigerator

1. There are shelves in the refrigerator compartment, and they can be taken out to be cleaned.



2. The crisper is suitable for the storage of vegetables and fruit, etc.



Freezer

The freezer compartment is suitable for storage of foods required to be frozen, such as meat, and ice.

CAUTION! Do not close the refrigerator door when installing a deep bracket, it may damage the unit.

Cleaning and care

For hygienic reasons the appliance (including exterior and interior accessories) should be cleaned regularly (at least every two months.)

WARNING!

The appliance must not be connected to the power source during cleaning as there is a danger of electrical shock! Before cleaning, switch the appliance off and remove the plug from the outlet.

Exterior cleaning

Wipe the control panel with a clean, soft cloth.

- Spray water onto the cleaning cloth instead of spraying directly on the surface of the appliance. This helps ensure an even distribution of moisture to the surface.
- Clean the doors, handles, and cabinet surfaces with a mild detergent and then wiped dry with a soft cloth.

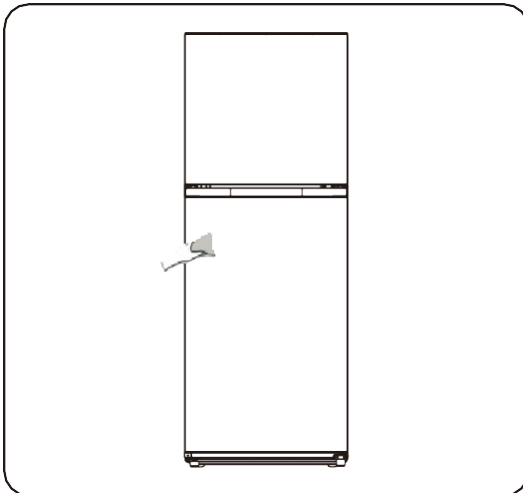

Caution!

- Do not use sharp objects as they are likely to scratch the surface.
- Do not use Thinner, Car detergent, Clorox, ethereal oil, abrasive cleaners, or an organic solvent such as Benzene for cleaning. They may damage the surface of the appliance and may cause a fire.

Interior cleaning

You should regularly clean the appliance interior. Wipe the inside of the refrigerator freezer with a weak solution of bicarbonate of soda, and then rinse with warm water using a wrung-out sponge or cloth. Wipe completely dry before putting back the shelves and baskets. Thoroughly dry all surfaces and removable parts before putting them back into place.

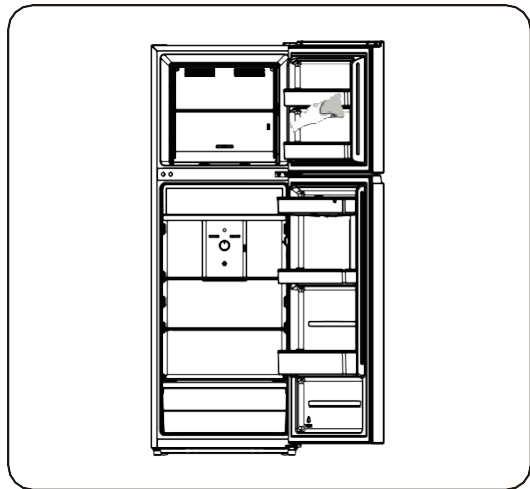

Although this appliance automatically defrosts, a layer of frost may occur on the freezer compartments interior walls if the freezer door is opened frequently or kept open too long. If the frost is too thick, make sure the freezer is nearly empty and proceed as follows:

1. Remove existing food and accessories baskets, unplug the appliance from the outlet, and leave the doors open. Ventilate the room thoroughly to accelerate the process.
2. When defrosting is complete, clean your freezer as described above.

CAUTION!

Do not use sharp objects to remove frost from the freezer compartment. Only after

the interior is completely dry should the appliance be switched back on and plugged back into the mains socket.

Door seals cleaning

Be sure to keep door seals clean. Sticky food and drinks can cause seals to stick to the cabinet and tear when you open the door. Clean the seal with a mild detergent and warm water. Rinse and dry it thoroughly after cleaning.

CAUTION! Only after the door seals are completely dry should the appliance be powered on.

Replacing the LED light:

WARNING!

Replacing the lightbulbs

The lightbulbs must not be replaced by the user. If the lightbulbs are damaged, contact the customer helpline at **(718) 893-3900** or visit our <https://www.summitappliance.com/support>.

To replace the LED light, follow the steps below:

1. Unplug your appliance.
2. Remove the light cover by pushing it up and out.
3. Hold the LED cover with one hand and pull it with the other hand while pressing the connector latch.
4. Replace the LED light and snap it correctly in place.
5. Reinstall the light cover.

Helpful tips

Energy saving tips:

We recommend that you follow the tips below to save energy.

- Try to avoid keeping the door open for long periods in order to conserve energy. Ensure the appliance is away from any sources of heat (Direct sunlight, electric oven, or cooker, etc.)
- Do not set the temperature colder than necessary.
- Don't store warm food or evaporating liquid in the appliance.
- Place the appliance in a well-ventilated, humidity-free, room. Please refer to Installing your new appliance chapter.
- If the diagram shows the correct combination for the drawers, crisper, and shelves, do not adjust the combination as this is designed to be the most energy-efficient configuration.

Tips for fresh food refrigeration

- Do not place hot food directly into the refrigerator or freezer, the internal temperature will increase resulting in the compressor having to work harder and will consume more energy.
- Cover or wrap the food, particularly if it has a strong flavor.
- Place food properly so that air can circulate freely around it.

Tips for refrigeration:

- **Meat (All Types):** Wrap in polythene food wrap and place on the glass shelf above the vegetable drawer. Always follow food storage times and expiration dates suggested by manufacturers.

- **Cooked food, cold dishes, etc.:**

They should be covered and may be placed on any shelf.

- **Fruit and vegetables:**

They should be stored in the special drawer provided.

Butter and cheese:

Should be wrapped in airtight foil or plastic film wrap.

Milk bottles:

Should have a lid and be stored in the door racks.

Tips for freezing:

- During the initial set-up or after a long period without being used, let the appliance run for at least 2 hours on the higher settings before putting food in the compartment.
- Prepare food in small portions so it can be rapidly and completely frozen and to make it possible to subsequently thaw only the quantity required.
- Wrap up the food in aluminum foil or polyethylene food wraps which are airtight,
- Do not allow fresh, unfrozen food to touch the food which is already frozen to avoid a rise in temperature of the latter.
- Frozen products, if consumed immediately after removal from the freezer compartment may cause frost burns to the skin.
 - It is recommended to label and date each frozen package in order to keep track of the storage time.

Tips for the storage of frozen food:

- Ensure that frozen food has been stored correctly by the food retailer
- Once defrosted, food will deteriorate rapidly and should not be re-frozen. Do not exceed the storage period indicated by the food manufacturer.

Switching off your appliance:

If the appliance needs to be switched off for an extended period, the following steps should be taken to prevent mold on the appliance.

1. Remove all food.
2. Remove the power plug from the electrical outlet.
3. Clean and dry the interior thoroughly.
4. Ensure that all the doors are wedged open slightly to allow air to circulate.

To avoid the cross-contamination of food, observe the following instructions:

- Regularly clean surfaces that come in contact with food and accessible drainage systems.
- Store raw meat and fish in suitable containers in the refrigerator, so that it does not make contact with or drips onto other food.

Compartments	Target Storage temp. [°C]	Food that should be stored in the compartment:
Refrigerator	2~8	Eggs, cooked food, packaged food, fruits and vegetables, dairy products, cakes, Drinks, and other foods which should or cannot be frozen.
Freezer	≤-18	Seafood (fish, shrimp, shellfish), freshwater aquatic products, and meat products (recommended time is 3 months – nutrition values and taste decrease with time), suitable for frozen fresh food.
	≤-18	Seafood (fish, shrimp, shellfish), freshwater aquatic products, and meat products (recommended time is 3 months – nutrition values and taste decrease with time). Not suitable for freezing fresh food.
	≤-12	Seafood (fish, shrimp, shellfish), freshwater aquatic products, and meat products (recommended time is 2 months – nutrition values and taste decrease with time). Not suitable for freezing fresh food.
	≤-6	Seafood (fish, shrimp, shellfish), freshwater aquatic products, and meat products (The recommended time is 1 month – nutrition values and taste decrease with time). Not suitable for freezing fresh food.
	-6~0	Fresh pork, beef, fish, chicken, and some packaged processed foods, etc. (It is recommended you eat these within the same day, preferably no later than 3 days). Seafood (less than 0 for 15 days, it is not recommended to store above 0°C).
	-2~+3	Fresh/frozen pork, beef, fish, chicken, freshwater aquatic products, etc. (It can be stored for 7 days below 0°C. But above 0°C it is recommended it is consumed no later than 2 days).
Fresh Food	0~+4	Fresh pork, beef, fish, chicken, cooked food, etc. (Recommended to eat within the same day, preferably no more than 3 days).
Wine	+5~+20	Red wine, white wine, sparkling wine, etc.

NOTE: Please store foods according to the compartments or the target storage temperature of your products.

- If the refrigerator is going to be left empty for long periods of time, switch it off, defrost it, clean it, dry it, and leave the door open to prevent mold from developing within the appliance.
- Food should be packed in bags before being placed in the refrigerator, and liquids need to be packed in bottles or in capped containers to avoid spillage.

Troubleshooting

If you experience a problem with your appliance or are concerned that the appliance is not functioning correctly, please refer to the table below before calling for service:

Problem	Possible Cause & Solution
Appliance is not working correctly	Check whether the power cord is plugged into the power outlet properly.
	Check the fuse or circuit of your power supply and replace it if necessary.
	It is normal that the freezer is not operating during the defrost cycle, or for a short time after the appliance is switched on to protect the compressor.
Odors from the compartments	The interior may need to be cleaned.
	Some food, containers, or wrapping cause odors.
Noise from the appliance	<p>The sounds below are normal:</p> <ul style="list-style-type: none"> - Compressor running noises. - Air movement noise from the small fan motor in the freezer compartment or other compartments. - Gurgling sounds like water boiling. - Popping noise during automatic defrosting. - Clicking noise before the compressor starts.
	<p>The noises below are unusual, and you may need to check and act:</p> <ul style="list-style-type: none"> - The cabinet is not level. - The back of the appliance touches the wall. - Bottles or containers falling or rolling.
The motor runs continuously	<p>It is normal to frequently hear the motor; it will need to run more in the following circumstances:</p> <ul style="list-style-type: none"> - Temperature setting is set colder than necessary. - Large quantity of warm food has recently been stored within the appliance., - The temperature outside the appliance is too high. - Doors are kept open too long or too often. - Right after the initial installation of the appliance or if it has been switched off for a long time.
A layer of frost in the compartment	Check that the air outlets are not blocked by food and ensure that the food placed within the appliance will allow sufficient ventilation. Ensure that the door is fully closed. To remove the frost, please refer to the “ Cleaning and Care ” section of this manual.

The temperature inside is too warm	You may have left the doors open too long or too frequently, or the doors are kept open by some obstruction; or the appliance was installed with insufficient clearance at the sides, back, and top
The temperature inside is too cold	Increase the temperature by following the “controls panel” chapter.
Doors can't be closed easily	Check whether the top of the refrigerator is tilted back by 10- 15mm to allow the doors to self-close, or if something inside is preventing the doors from closing.

If you have checked the table above and find that you still need help with your refrigerator or freezer, call our Customer Service facility at **800-932-4267** between 9:00 AM and 5:00 PM ET or visit: www.summitappliance.com/support. We will do our best to answer your questions.

Disposal of the appliance

It is prohibited to dispose of this appliance as household waste.

Packaging materials

Packaging materials with the recycle symbol are recyclable. Dispose of the packaging into a suitable waste collection container to recycle it.

Before disposal of the appliance

2. Pull out the mains plug from the mains socket.
3. Cut off the power cord and discard with the mains plug

Warning! Refrigerators contain refrigerant and gases in the insulation. Refrigerants and gases must be disposed of professionally as they may cause eye injuries or ignition. Ensure that the tubing of the refrigerant circuit is not damaged prior to proper disposal.

Correct Disposal of this product	
	<p>This symbol on the product or in its packing indicates that this product may not be treated as household waste. Instead, it should be taken to the appropriate waste collection point for the recycling of electrical and electronic equipment. By ensuring this product is disposed of correctly, you will help prevent potential negative consequences for the environment and human health, which could otherwise be caused by the inappropriate waste handling of this product. For more detailed information about the recycling of this product, please contact your local council your household waste disposal service, or the shop where you purchased the product.</p>

LIMITED WARRANTY

ONE-YEAR LIMITED WARRANTY

Within the 48 contiguous United States, for one year from the date of purchase, when this appliance is operated and maintained according to instructions attached to or furnished with the product, warrantor will pay for factory-specified parts and repair labor to correct defects in materials or workmanship. Service must be provided by a designated service company. Outside the 48 states, all parts are warranted for one year from manufacturing defects. Plastic parts, shelves and cabinets are warranted to be manufactured to commercially acceptable standards and are not covered from damage during handling or breakage.

5-YEAR COMPRESSOR WARRANTY

1. The compressor is covered for 5 years.
2. Replacement does not include labor.

ITEMS WARRANTOR WILL NOT PAY FOR:

1. Service calls to correct the installation of your appliance, to instruct you how to use your appliance, to replace or repair fuses or to correct wiring or plumbing.
2. Service calls to repair or replace appliance light bulbs or broken shelves. Consumable parts (such as filters) are excluded from warranty coverage.
3. Damage resulting from accident, alteration, misuse, abuse, fire, flood, acts of God, improper installation, installation not in accordance with electrical or plumbing codes, or use of products not approved by warrantor.
4. Replacement parts or repair labor costs for appliances operated outside the United States.
5. Repairs to parts or systems resulting from unauthorized modifications made to the appliance.
6. The removal and reinstallation of your appliance if it is installed in an inaccessible location or is not installed in accordance with published installation instructions.

DISCLAIMER OF IMPLIED WARRANTIES – LIMITATION OF REMEDIES

CUSTOMER'S SOLE AND EXCLUSIVE REMEDY UNDER THIS LIMITED WARRANTY SHALL BE PRODUCT REPAIR AS PROVIDED HEREIN. IMPLIED WARRANTIES, INCLUDING WARRANTIES OF MERCHANTABILITY OR FITNESS FOR A PARTICULAR PURPOSE, ARE LIMITED TO ONE YEAR. WARRANTOR SHALL NOT BE LIABLE FOR INCIDENTAL OR CONSEQUENTIAL DAMAGES. SOME STATES DO NOT ALLOW THE EXCLUSION OR LIMITATION OF INCIDENTAL OR CONSEQUENTIAL DAMAGES, OR LIMITATIONS ON THE DURATION OF IMPLIED WARRANTIES OF MERCHANTABILITY OR FITNESS, SO THESE EXCLUSIONS OR LIMITATIONS MAY NOT APPLY TO YOU. THIS WARRANTY GIVES YOU SPECIFIC LEGAL RIGHTS AND YOU MAY ALSO HAVE OTHER RIGHTS, WHICH VARY FROM STATE TO STATE.



WARNING: This product can expose you to chemicals including Nickel (Metallic) which is known to the State of California to cause cancer.

For more information go to www.P65Warnings.ca.gov

Note: Nickel is a component in all stainless steel and some other metallic compositions.

Felix Storch, Inc.
An ISO 9001:2015 registered company
770 Garrison Ave
Bronx, New York 10474
www.summitappliance.com

SUMMIT®

For parts and accessory ordering,
troubleshooting, and helpful hints,
visit:

www.summitappliance.com/support