

## F 2672 Vi MasterCool™ freezer

For high-end design and technology on a large scale.



- Push2open for convenient door-opening assistance
- Light floods the interior thanks to LED elements – BrilliantLight
- Ice and cooled-water dispensers for maximum convenience
- Convenient control thanks to color touch display MasterSensor

EAN: 4002516323143 / Material number: 11503550 / Old Material Number: 37267201USA

<b>Appliance category</b>	
Freezer	•
<b>Construction type</b>	
Built-in	•
Built-in integrated	•
Door hinge side	Left
Can be installed side-by-side	•
<b>Design</b>	
Lighting	BrilliantLight
<b>Control panel</b>	
Ice/water dispenser	•
Networking with Miele@home	•
NoFrost	•
IceMaker with mains water connection	•
Push2open	•
FullAccess	•
EasyClean	•
MaxLoad hinge	•
<b>Control</b>	
Electronic temperature display and control	MasterSensor
Independent temperature control of fridge and freezer compartments	No
SuperFrost	•
No. of temperature zones	1
Sabbath mode	•
Eco mode	•
<b>Fridge / Fridge compartment</b>	
Door baskets – small	1
Door baskets – large	3
<b>Freezer/Freezer compartment</b>	
Number of shelves	2
Number of freezer baskets	2
<b>Efficiency and sustainability</b>	
Energy Star Qualified	•
<b>Safety</b>	
Lock function	•
Acoustic door alarm	•
Acoustic temperature alarm, freezer section	•
Optical door alarm	•
Optical temperature alarm	•
<b>Technical data</b>	
Niche width in inches (mm), min.	24 1/8 (610)
Niche width in inches (mm), max.	24 1/8 (610)
Niche height in inches (mm), min.	84 1/8 (2134)
Niche height in inches (mm), max.	84 1/8 (2134)
Niche depth in in.(mm)	24 7/8 (629)
Appliance width in in.(mm)	23 3/4 (603)
Appliance height in in.(mm)	83 3/4 (2125)
Appliance depth in in.(mm)	24 (608)
Weight in lbs.(kg)	316 (143.3)

## F 2672 Vi MasterCool™ freezer

For high-end design and technology on a large scale.



EAN: 4002516323143 / Material number: 11503550 / Old Material Number: 37267201USA

Type of mounting	Fixed door
Maximum fridge compartment door front weight in lbs. (kg)	150 (68)
Storage time in case of fault in h	10
Current consumption in milliampere (mA)	4000
Voltage in V	110-120
Fuse rating in A	10
Number of phases	1
Frequency in Hz	60
Wire length in ft (m)	9 (3.0)
Replacing bulbs	Customer Service

### Available display languages

Available display languages via MultiLingua

bahasa malaysia, dansk, deutsch, eesti, english, english (AU), english (CA), english (GB), english (US), español, français, français (CA), français (FR), hrvatski, italiano, latviesu, lietuviu, magyar, nederlands, norsk, polski, portuguis, русский, română, slovenčina, slovenščina, srpski, suomi, svenska, türkçe, українська, čeština, ελληνικά,

F 2672 Vi  
MasterCool™ freezer  
For high-end design and technology on a large scale.

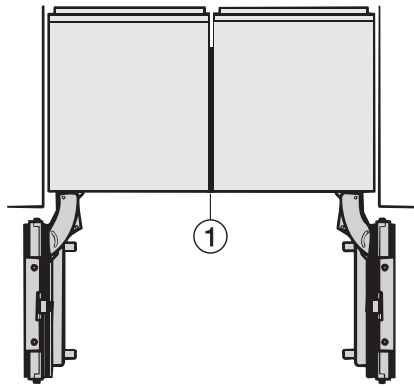

Side-by-side, MasterCool, without partition wall, with heating mat (Sketch) (with footnote)

1) Heating mat KSK 2001 (EU, AUS, CN) or KSK 2002 (US, CA, MX, BR)

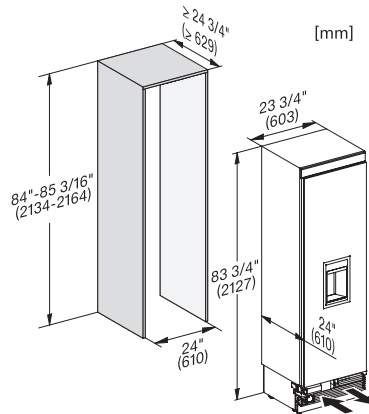

F2672Vi, F2662Vi, F2671Vi, F2661Vi, installation, MasterCool (installation drawings)

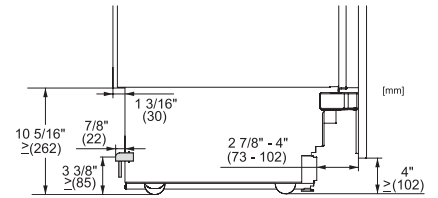

Sideview, MasterCool, Sketch

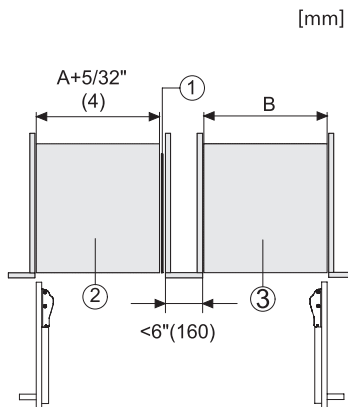

Side-by-Side, MasterCool, footnote, installation drawings

1. KSK 2001/2002, 2. Device A, 3. Device B, A = niche device A, B = niche device B

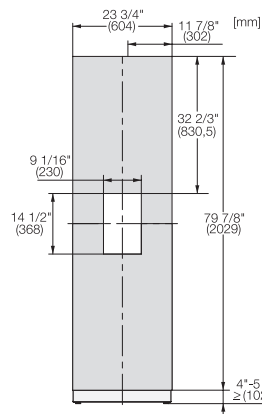

KFP2445ed/cs, KFP2444ed/cs, Front panel, Front dimensions, MasterCool, installation drawings

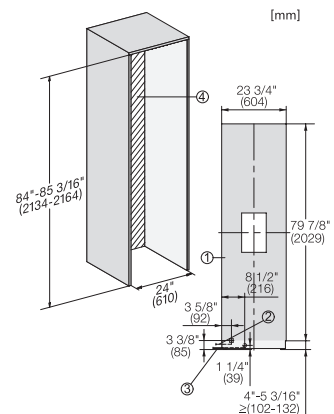

F2672Vi, F2672SF, F2662Vi, F2671Vi, F2671SF, F2661Vi, MasterCool, installation, installation drawings

1. View from the front, 2. Mains Connection cable, L = 3000 mm (118 inch), 3. Water inlet position, L = 2000mm (not for KON USA), 4. No water/ELT connections permitted in this area