

Super Combo

ALL-IN-ONE COMBO WASHER ⊕ DRYER

Model: 5500

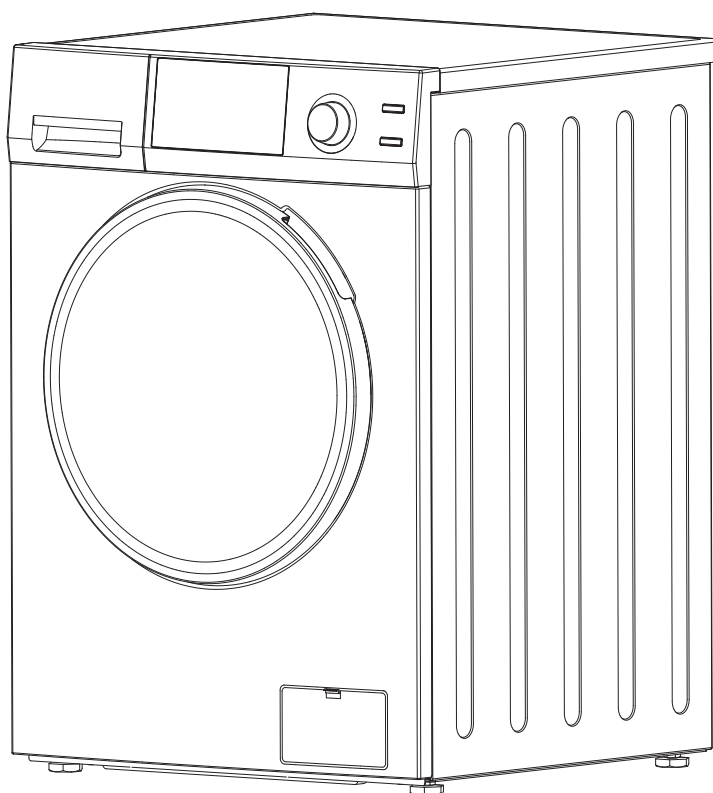

OWNER'S MANUAL

Please read the instructions carefully and keep for future reference. Information may be updated from time to time so please refer to the website for the latest version of the manual.

TABLE OF CONTENTS

**Please read the Owner's Manual carefully before using your
ALL-IN-ONE COMBO WASHER ⊕ DRYER**

Introduction	1
Warranty	2
Technical Data	5
Important Safety Instructions.....	6
Helpful Hints	7
Pre-installation	7
Diagram of the Combo	8
Installation Instructions.....	9
Unpacking and Leveling	10
Electrical	11
Plumbing	13
Ventilation	14
Built-In, Recessed, Closet, Alcove Installation	15
Program Selection Chart	16
Operating Instructions	17
Control Panel	18
Display Panel	19
Understanding Fabric Care Label	20
Maintenance	21
Stain Removal Chart	22
Troubleshooting	24
Diagnostic Menu	25

INTRODUCTION

Congratulations on your new Super Combo! In addition to its contemporary design, this is a highly sophisticated engineered product that will give you many years of satisfaction.

Here are some of the best reasons for buying your Super Combo

1. **Space Saving**

By combining the two functions of washer and dryer in one unit, the space taken for the second unit, i.e. separate dryer, is saved.

2. **Placement Options**

The Washer⊕Dryer's sleek and compact size design makes it a perfect appliance for any kitchen or laundry room.

3. **Water & Energy Saving**

New automatic water level feature determines the amount of water required based on quantity of clothes which helps save water. Also this appliance is engineered to provide valuable energy savings e.g., LED display goes off after 5 mins to save energy.

4. **Better Clothing Appearance**

This Washer⊕Dryer has no agitator to damage your clothes so they look better and last longer.

5. **Specialized Wash Programs**

There are special wash programs for Sanitize, Allergen, Winterize etc.

6. **Refresh Function**

The refresh function keeps your clothes warm and fluffy always.

7. **Flexible Drying option**

With the option to change from a Ventless Dry (Condensing) system to a Vented Dry, you can decide on the ideal dry system depending on availability of a venting outlet and weather.

8. **High spin speed**

With a high spin speed of 1400 rpm, more water is extracted, allowing improved dry times.

9. **Easy Operation**

This appliance is simple to use as a washer or as a dryer – or it can go seamlessly from wash to the dry functions.

10. **Sensor Dry**

This function automatically selects the ideal dry level to make sure your clothes are dried with utmost perfection based on wash cycle used.

11. **Lint Free Maintenance**

Since the machine has a self-cleaning pump, this appliance needs no cleaning of lint after drying. Instead, there is a convenient coin trap.

12. **Portability**

The appliance can be permanently installed or made portable with the installation of the portability kit (Accessory Part #1070 sold separately) where needed.

WARRANTY INFORMATION

Your appliance is protected by this warranty under normal, personal, family or household use for 1 Year Parts & Labor and limited commercial use (90 days) in USA and Canada.

WARRANTY

Consolidated Brands undertakes to the consumer / owner to repair or, at our option, to replace any part of this product which proves to be defective in workmanship or material under normal personal, family or household use, in USA and Canada, for a period of one year parts & labor from the date of original purchase. For commercial use, the product is warranted for a period of 90 days.

During this period, we will provide all labor and parts necessary to correct such defect, free of charge, if the appliance has been installed and operated in accordance with the written instructions provided with the appliance. Ready access to the appliance, for service, is the responsibility of the consumer / owner. If a unit is installed in a closet or cabinet, it should be removed by the consumer / owner, for access by service technicians. If this is not done, there will be an extra charge.

EXCLUSIONS

In no event shall Consolidated Brands be liable for incidental or consequential damages or for damages resulting from external causes such as abuse, operation misuse, neglect, alterations, normal wear and tear, incorrect voltage or acts of God. This warranty does not cover service calls which do not involve defective workmanship, damage due to other products while combined use with this product or materials covered by this warranty. Accordingly, diagnosis and repair costs for a service call which does not involve defective workmanship or materials will be the responsibility of the consumer / owner.

Most work is covered. The defining factor is, has the machine malfunctioned (Consolidated Brands is responsible) or has the customer omitted or done something to cause malfunction (customer is responsible). Some states do not allow the exclusion or limitation of incidental or consequential damages, so the above limitation or exclusion may not apply to you.

You can register your warranty by either of the following methods:

1. Scan the QR Code
2. Online at: ApplianceDesk.com/Warranty

QR Code



1. Open Smart Phone
2. Open Camera
3. Scan QR Code
4. Click the Link

WARRANTY SERVICE

This warranty is given by:

Consolidated Brands
10222 Georgibelle Drive, Suite 200,
Houston, TX 77043-5249

Customer Service: **Appliance Desk**
Phone / Text: 1-800-776-3538
Email: Service@ApplianceDesk.com
Web: www.ApplianceDesk.com
Business hours: 9:00 am to 5:00 pm weekdays

THE FOLLOWING WORK ARE NOT COVERED UNDER WARRANTY:

A) Installation

1. Non-removal of shipping bolts, causing vibration / internal damage.
2. Non-adjustment of feet to level machine, causing vibration / internal damage.
3. Non-removal of exhaust vent plate at the back while using Venting Dry mode, causing excess heat and resulting in damage to internal components.
4. Not conforming to minimum space requirements for built-in installation, causing excess heat and resulting in damage to internal components.
5. Using incorrect length of venting i.e. more than 10 feet unless used with a booster exhaust fan.
6. Installation in a corrosive environment.
7. Incorrect water pressure i.e., below 7.25 psi or above 145 psi.
8. Incorrect water inlet hose installation (use only factory supplied hoses with metric threads on the L-shaped side to fit water valve).

B) Maintenance

1. Non-cleaning of coin trap for debris, causing the unit to not drain out water and resulting in drain pump malfunction.
2. Non-cleaning of exhaust fan and exhaust hose for lint, causing the unit to not dry properly.
3. Improper maintenance (such as, but not limited to, scale build-up, freeze damage, or vent blockage).

C) Damage

1. Breakage of cosmetic parts e.g., door handle, knob.

D) Other

1. Accident, abuse, or misuse.
2. Using solvents to clean the machine or wash clothes, causing damage.
3. Misapplication of this product e.g., use in a non-household / commercial environment.
4. Any other cause not due to defects in materials or workmanship.
5. Problems or damage due to fires, flooding, electrical surges, freezing or any acts of God.
6. Any damage caused by poor water quality.
7. Operating the appliance with anything other than potable water at all times.
8. Force majeure.

California Proposition 65

WARNING: This product contains chemical known to the State of California to cause cancer and birth defects or other reproductive harm.

Warranty Limitations

1. If a unit is located more than 25 miles away, there will be a trip charge.
2. If a unit is in a remote area more than 75 miles away, the machine should be taken to the technician's workshop.
3. If the unit is installed in a 5th wheel RV, in a location behind the axle, it will not be covered under warranty.
4. All repairs or replacements are warranted only for the remainder of the original warranty period.
5. If a return or replacement is required, allow 3-4 weeks to process.
6. Replacement units will be delivered with curbside delivery only.
7. We may require the return of products or parts to our warranty department for which the shipping charges are to be pre-paid by the consumer / owner.
8. Charges may be incurred if warranty coverage is not applicable.
9. Service would be provided from Monday to Friday between normal business hours.

GENERAL

Since it is the responsibility of the consumer / owner to establish the warranty period by verifying the original purchase date, Consolidated Brands recommends that a receipt, delivery slip or some other appropriate payment record be kept for that purpose. This warranty gives you specific legal rights, and you may also have other rights which vary from state to state.

All rights reserved. Manual subject to change without notice.

TECHNICAL DATA

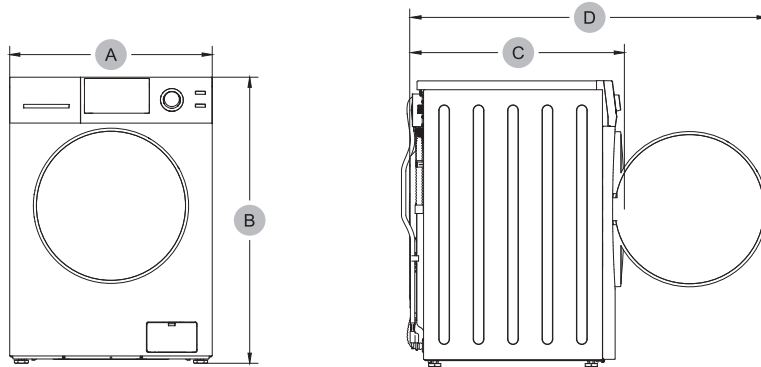

Type		Front loading washer-dryer combo
Model		5500
Dimensions (inches / cm)	A. Width	23.6 / 60
	B. Height-overall	33.5 / 85
	C. Depth	24.8 / 63
	D. Depth with door open	41.3 / 105
Rated voltage		110-120V / 60Hz 13A
Water pressure (psi / Mpa)		7.25 - 145 / 0.05 - 1.00
Wash capacity (lb / kg)		18 / 8.0
Dry capacity (lb / kg)		Max. 9 / 4.0
Net weight (lb / kg)		190 / 86
Spin revolution		Max. 1,400 rpm
Power consumption (W)	Washing	120 W
	Spin	500 W
	Wash heater	1,000 W
	Dry heater	1,300 W
Inlet and Drain Hose length		6 Feet
Power cable length		6 Feet



Intertek

4007606

US N° 4007606 CANADA

The ETL Listed Mark is the legal equivalent to the UL and CSA Listed Marks

Note: All rights reserved.
Designs, Specifications and Manual subject to change without notice.

IMPORTANT SAFETY INSTRUCTIONS



Your Combo Washer ⊕ Dryer has been built in compliance with safety regulation to protect you and your family.

WARNING – To reduce the risk of fire, electric shock, or injury to persons when using your appliance, follow basic precautions, including the following:

1. Read all instructions before using the appliance.
2. Do not wash or dry articles that have been previously cleaned in, washed in, or spotted with gasoline, dry-cleaning solvents, other flammable or explosive substances, as they emit vapors that could ignite or explode.
3. Do not allow children to play on or in the appliance. Close supervision of children is necessary when the appliance is used near children.
4. Before the appliance is removed from service or discarded, remove the door.
5. Do not reach into the appliance if the tub or drum is moving.
6. Do not install or store this appliance where it will be exposed to the weather.
7. Do not tamper with controls.
8. Do not repair or replace any part of the appliance or attempt any servicing unless specifically recommended in the user-maintenance instructions or in published user-repair instructions that you understand and have skills to carry out.
9. Do not add gasoline, dry-cleaning solvents, or other flammable or explosive substances to the wash water. These substances give off vapors that could ignite or explode.
10. Under certain conditions, hydrogen gas may be produced in a hot water system that has not been used for 2 weeks or more. **HYDROGEN GAS IS EXPLOSIVE.** If the hot water system has not been used for such a period, before using a washing machine or combination washer-dryer, turn on all hot water faucets and let the water flow from each for several minutes. This will release any accumulated Hydrogen.
11. Do not use fabric softeners or products to reduce static unless recommended by the manufacturers of the fabric softener product.
12. Do not use heat to dry articles containing foam rubber or similarly textured rubber-like materials.
13. Check the Coin Trap every few months to remove any coins, buttons or similar size objects.
14. For vented washer-dryers keep the exhaust opening and surrounding areas free from accumulation of lint, dust, and dirt.
15. Do not place items exposed to cooking oils in your dryer. Item contaminated with cooking oils may contribute to a chemical reaction that could cause a load to catch fire.
16. To reduce the risk of fire due to contaminated loads, the final part of a tumble dryer cycle occurs without heat (cool down period). Avoid stopping a tumble dryer before the end of the drying cycle unless all items are quickly removed and spread out so that the heat is dissipated.

SAVE THESE INSTRUCTIONS

SAFETY

 CAUTION 	The model number and the serial number are on the label affixed to the back of the unit. These numbers are also available on the front of the cabinet behind the door.
RISK OF ELECTRIC SHOCK DO NOT OPEN	You should note the model and serial numbers of this unit in the space provided. Retain this booklet as a permanent record of your purchase to aid in identification in the event of theft.
CAUTION: TO REDUCE THE RISK OF ELECTRIC SHOCK, DO NOT REMOVE COVER (OR BACK). NO USER SERVICEABLE PARTS INSIDE. REFER SERVICING TO QUALIFIED SERVICE PROFESSIONALS.	MODEL No: _____ SERIAL No: _____

HELPFUL HINTS

1. Your Washer⊕Dryer spins at a high 1400 rpm spin speed, which will extract more water especially from absorbent fabrics and reduce the degree of dampness as the machine goes into the drying mode. This will cut down on your drying time.
2. **FABRIC SOFTENER:** After the wash cycle, the clothes can get stuck to the sides of the drum. USING LIQUID FABRIC SOFTENER WILL CAUSE THE CLOTHES TO UNSTICK IMMEDIATELY AND TUMBLE IN THE DRY CYCLE. THIS HELPS TO DRY CLOTHES FASTER AND CAUSES LESS WRINKLES.
3. **OVERLOADING:** The drum has a capacity of 19 lbs. The drum should be loaded only to 2/3 of its capacity otherwise it reduces air flow and causes increase in dry time.
4. **DRYING:**
 - A) Condensing - Since there is no external exhaust system, the moisture content remains in the machine. Frequently when it seems the clothes are damp, it is actually the remaining moisture (like dew). Take clothes out and they will dry within a few minutes.
 - B) Venting - It uses hot air to dry the clothes.
5. **USE HIGH EFFICIENCY (HE) DETERGENT:** By using High Efficiency (HE) detergent, you are preventing suds from entering the condensing chamber. When suds enter the condensing chamber, the particles can clog up the chamber and the fan blower. Over time, this reduces drying efficiency and may require the fan blower (impeller) to be cleaned. For this and all other front-loading/horizontal-axis units, Front Loading detergents go a long way to improve the efficiency of the units.
6. **SORTING:** When sorting laundry always take into consideration the quantity and type of fabric contained in the load. Highly absorbent fabrics such as those used in towels or jeans will absorb more water and become very heavy when saturated. If you notice that your clothes are taking longer than usual to dry you may be overloading the machine, or washing too many highly absorbent articles in a single load.

PRE-INSTALLATION

1. The unit must be installed on a strong leveled surface in a protected, dry and well-ventilated area, with a power and water supply of sufficient capacity and a sufficient outlet in close proximity.
2. Installation on Carpet or Wood increases vibrations.
 - Carpets – place on light carpet only.
 - Wood – brace floor with screws and place additional sheets of plywood before installation.
3. This unit's installation and grounding should be done in accordance with local codes by a qualified installer. "Installation Instructions" are included in this manual for the Installer's reference.
4. The unit should be plugged into a properly grounded three (3) prong electrical outlet of 110V/60Hz with minimum 15 Amps, It should not be controlled by a wall switch or pull cord which might be turned off accidentally.

DIAGRAM OF THE COMBO WASHER ⊕ DRYER

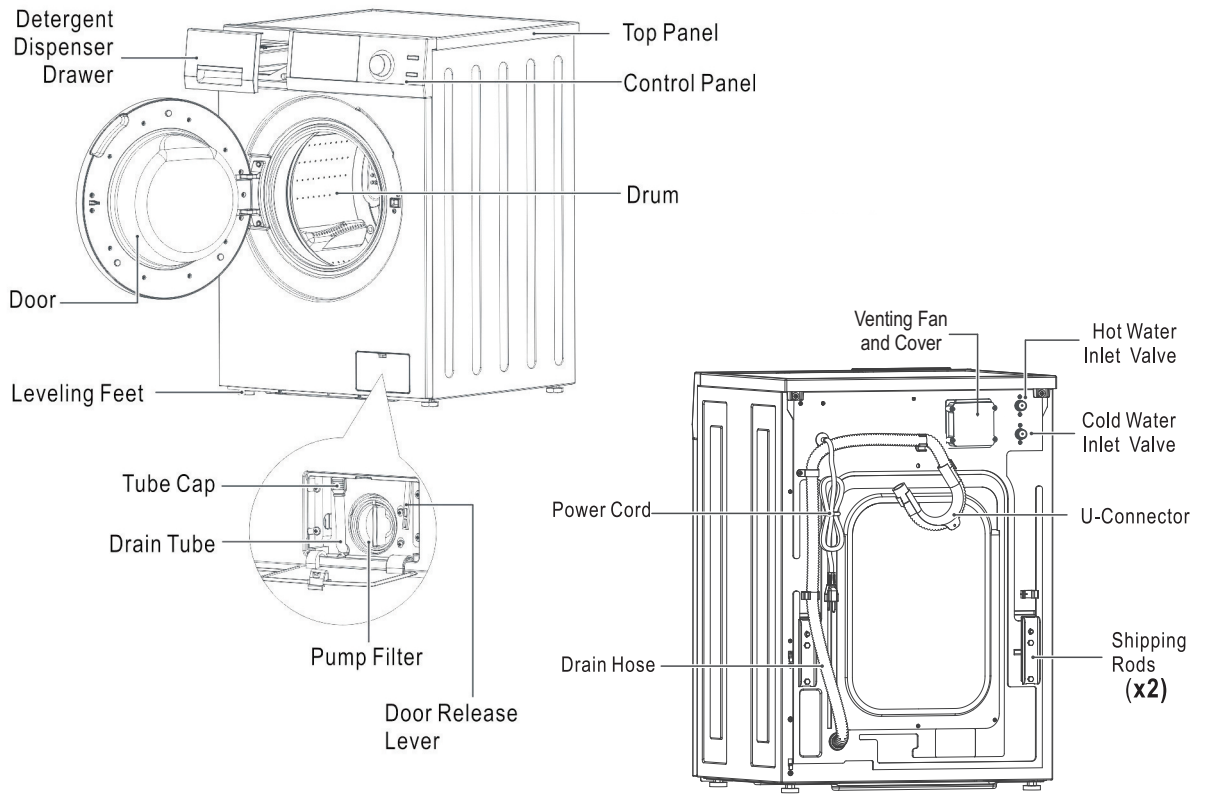

Factory supplied accessories

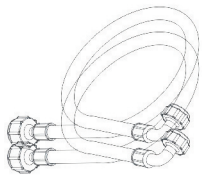

Water Inlet Hoses



U-Connector
(For drain hose)

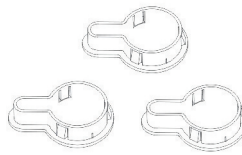

Blanking Caps - 3
(To cover shipping bolts hole)



Vent Adapter
(To connect vent hose to exhaust fan)

INSTALLATION INSTRUCTIONS

Handling

Please handle the machine carefully and use appropriate means while lifting and moving the machine so that it does not get damaged. Do not drag the machine on your floor. Do not hold on to protruding parts when lifting.

Disposing of the packing

The shipping package has protected your new appliance on its way to your home. All packaging materials are non-polluting and recyclable. Please dispose of packing material according to local environmental regulations.

DANGER

Keep children away from the shipping carton and packing components. Danger of suffocation from plastic foil and folding cartons.

Disposing of your old appliance

Old Appliances are not worthless trash! Valuable raw material can be recycled from old appliances. To prevent children from locking themselves in the appliances, remove the door. Please dispose of your old appliance according to local environmental regulations.

Factory - supplied equipment

Inside the drum there is a packet of accessory parts supplied with your appliance. Check that all the accessory parts supplied for your model are there. If any parts are missing contact customer service.

Any residual moisture inside the drum is due to the final testing which every appliance undergoes before leaving the factory.

Installation area

DANGER

Appliance stability is very important otherwise washing machine could "wander" during the spin cycles.

The installation area must be solid and even. Soft floor surfaces such as carpets or surfaces with foam backing are not suitable.

DANGER

Do not install the appliance outdoor or in an area exposed to freezing condition. frozen hoses can tear / burst.

If the appliance is located in a room which will be exposed to temperatures below freezing point, or if it is located in a cabin that is being shutdown for the winter, any residual water in the pump or water inlet hoses must be drained.

Removing the shipping rods

CAUTION

The shipping rods must be removed before using the appliance for the first time and must be retained for any future transport. (e.g when moving)

UNPACKING, LEVELING & POSITIONING

Remove the packing and check that the Super Combo is undamaged. If you have any doubt, do not use the Super Combo and call Customer Service. Keep all packing parts (plastic bag, foam rubber, screws, etc.) out of the reach of children since they could be dangerous.

Important: The inside of the Super Combo consists of a free floating drum that is affixed with shipping bolts at the back of the cabinet during transport (Fig.1). The power cord can be accessed by removing the shipping bolts (Fig. 2 & 3). Close the holes left open by the bolts with the caps provided (Fig. 4).

It is important for the machine to be perfectly level. For this reason, the machine is fitted with adjustable feet used for leveling the machine before use (Fig. 5).

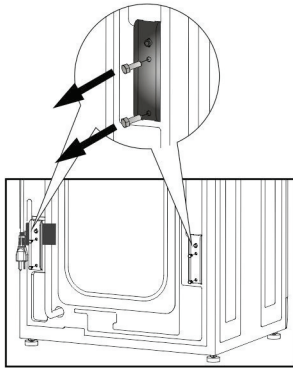

Fig.1

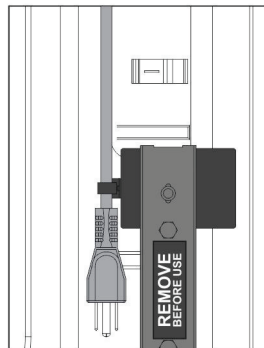

Fig.2

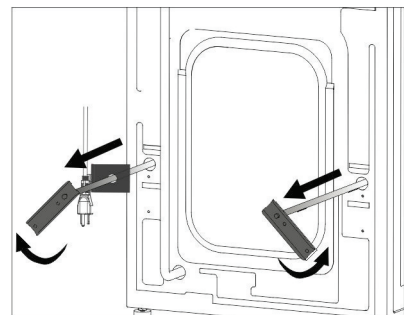

Fig.3

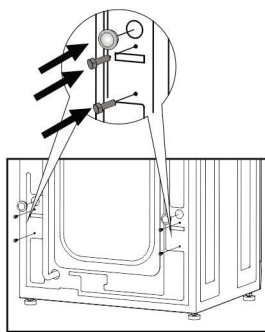

Fig.4

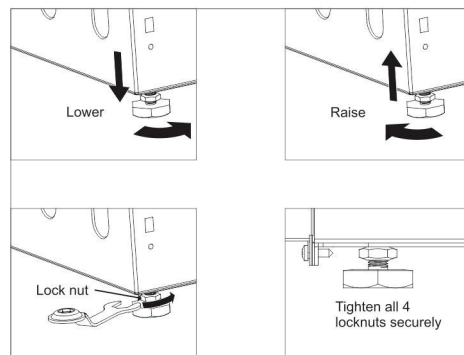

Fig. 5

! NOTE

- Save the bolt assemblies for future use. To prevent damage to internal components, DO NOT transport the washer-dryer combo without reinstalling the shipping bolts.
- Failure to remove shipping bolts and retainers may cause severe vibration and noise, which can lead to permanent damage to the combo.
- The cord is secured to the back of the combo by a clamp with a shipping bolt to help prevent operation with shipping bolts in place.
- An adjustable wrench or 17mm open end wrench is required when loosen or tighten the leveling feet.

CONNECTION

Connect the plug to a power outlet - 110V/60Hz with minimum 15 Amps. Make sure that the voltage and frequency available correspond with those stated on the serial number plate located on the machine. Do not use adaptors or extension cords since they could result in overheating and burn out.

POWER SUPPLY

This Washer⊕Dryer must be connected to an individual circuit identical to the one specified on the rating plate of the loading port protected by fuses or circuit breaker conforming to local codes.

GROUNDING

This appliance must be grounded. In the event of malfunction or breakdown, grounding will reduce the risk of electric shock by providing a path of least resistance for electric current. This appliance is equipped with a power cord having an equipment-grounding conductor and a grounding plug. The plug must be plugged into an appropriate outlet that is properly installed and grounded in accordance with all local codes and ordinances.

WARNINGS

- Improper connection of the equipment-grounding conductor can result in a risk of electric shock. Check with a qualified personnel or service representative if you are in doubt as to whether the appliance is properly grounded.
- Do not modify the plug provided with the appliance: if it will not fit the outlet, have a proper outlet installed by a qualified electrician.

Note: If the electrical power supply does not meet the specifications listed above, please call a licensed electrician.

Dryer can be used in Ventless or Vented mode



Icon for Ventless



Icon for Vented

VENTLESS (CONDENSING) DRY

Use dryer in Ventless Mode:

1. ENSURE METAL VENT COVER (1) IS INSTALLED OVER EXHAUST FAN AS SHOWN IN FIG.8
2. Power on the machine
3. Press "Dry Only" button to set the machine on drying cycle.
4. Hold Vented/Ventless button for 5 seconds
5.  symbol will appear on the screen which confirms that the machine is in Ventless mode.
6. Press START to run dryer in Ventless mode.

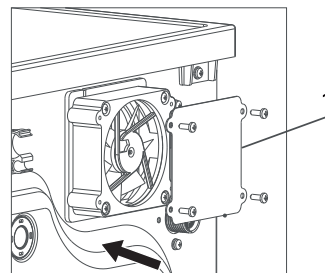



Fig.8

Ventless dry (condensing) uses cold water to dry the clothes. The cold water mixes with the hot air in a condensing chamber within the machine. Please ensure the cold water faucet is open during ventless dry mode.

Note: Slight condensation can occur at soap dispenser and will evaporate. This is a normal feature.

VENTED (HOT AIR) DRY

Use dryer in Vented mode:

1. ENSURE METAL VENT COVER OVER THE EXHAUST FAN IS REMOVED.
2. Press "Dry Only" button to set the machine on drying cycle.
3. Hold Vented/Ventless button for 5 seconds.
4.  symbol will appear on the screen which confirms that the machine is in vented mode.
5. Press START to run dryer in vented mode.

Connecting the dryer vent duct

For venting function the machine vents the moist hot air out of the unit and requires a vent hose (standard 4" diameter) to be installed.

Vent hose adapter is provided along with the machine which needs to be installed on exhaust fan, with screws provided for vent cover.

To install the vent hose, attach the vent hose (2) onto the vent hose adapter (1) as shown in Fig.9

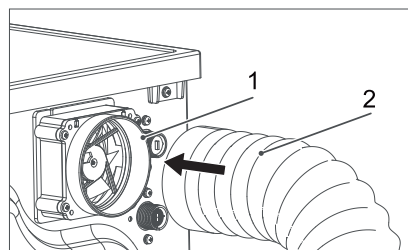

Fig.9

INSTALLATION INSTRUCTIONS FOR EXHAUST



IMPORTANT: Installation and service must be performed by a qualified installer. Please have a qualified service agent install your dryer.

NOTE: The **WARNING** and **IMPORTANT** instructions appearing in his manual are not meant to cover all possible conditions and situations that may occur. It must be understood that common sense and being careful are factors that **CANNOT** be built into the Washer-Dryer. These factors **MUST BE** supplied by the persons installing, maintaining, or operating the dryer.

CONNECTING TO THE WATER FAUCET

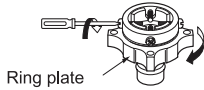

1. Unscrew the adapter ring plate and the 4 adapter retaining screws.

Guide plate

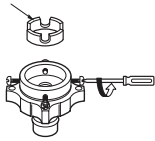

2. Remove the guide plate if the tap is too large to fit the adapter.

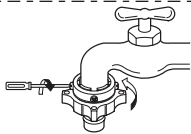

3. Push the adapter onto the end of the tap so that the rubber seal forms a watertight connection. Tighten the adapter ring plate and the 4 screws.

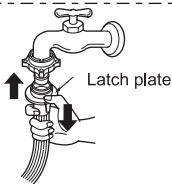

4. Pull the connector latch plate down, push the inlet hose onto the adapter, and release the connector latch plate. Make sure the adapter locks into place.

CONNECTING TO THE MACHINE

Make sure that there are no kinks in the hose and that they are not crushed. (Fig.6)



NOTE

After connecting inlet hose to water tap, turn on the water taps to flush out foreign substances (dirt, sand or sawdust) in the water lines. Let water drain into a bucket and check the water temperature.



NOTE

After completing connection, if water leaks from the hose, repeat the same steps. Use the most conventional type of faucet for water supply. In case the faucet is square or too big, remove the spacing ring before inserting the faucet into the adaptor.

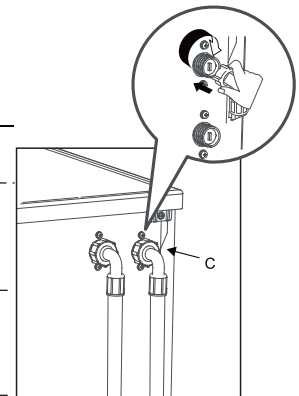

Fig.6

CONNECTING THE DRAIN HOSE

Connect the drain hose to a drain duct (with internal diameter of at least 1.6") or place it for drainage in to a sink or a tub, ensuring that there are no kinks or bends. The free end must be at a height of 24" - 40" from the floor. The hose can be held in place using the white plastic clamp on the upper part of the back panel.

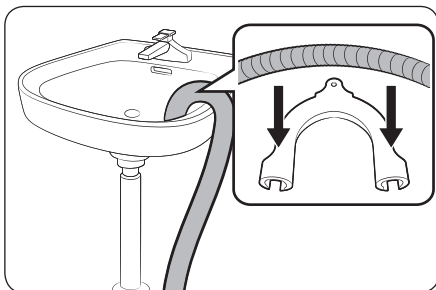

Fig.7

Height difference between the installation location of the washing machine and the drainage point:
Minimum 24" to Maximum 40"

- Attach water drain hose to U-Connector.
- Hook the U-Connector over the side or stand pipe (Fig 7.)
- When the water is being drained, check that the water flow out of the hose is adequate.

WARNINGS

MAXIMUM LENGTH OF THE VENT HOSE IS 10 FEET WITH THE 0.5 AMPS ORIGINAL EXHAUST FAN. USING LONGER VENT HOSE MAY DAMAGE INTERNAL COMPONENTS. FOR LONGER VENT HOSE USE 1.5 AMPS EXHAUST FAN, WHICH IS AVAILABLE AS AN ACCESSORY.

DUE TO RISK OF FIRE USE ONLY METALLIC DUCT (RIGID OR FLEXIBLE).

Never use flexible duct inside the dryer.

Do not terminate exhaust in a chimney, range hood, gas vent, floor or attic. The combination of lint and grease could create a fire hazard or damages.

Provide an access for inspection and cleaning the exhaust system at least once a year.

EXHAUST SYSTEM CHECK LIST HOOD OR WALL CAP

Terminate in a manner to prevent back drain or entry of birds or other wildlife.

Termination should present minimal resistance to the exhaust air flow and should require little or no maintenance to prevent clogging.

Wall caps must be installed at least 12" above ground level or any other obstruction with the opening pointed down.

If roof vents or louvered plenums are used, they must be equivalent to a 4" dampened wall cap in regard to resistance to air flow. Prevention of back drafts and regular maintenance are required to prevent clogging.

SEPARATION OF TURNS

Separate all turns by at least 3 feet (1 meter) of straight duct, including distance between last turn and dampened wall cap. If two turns must be closer than 3 feet (1 meter) deduct 10 feet (3 meters) from the maximum length.

URNS OTHER THAN 90°

One turn of 45° or less may be ignored.

Two 45° turns should be treated as one 90°.

Each turn over 45° should be treated as one 90°.

For each 90° turn, deduct 33 feet (10 meters) from maximum length.

SEALING OF JOINTS

All joints should be tight to avoid leaks. The male end of each section of duct must point away from the dryer.

Do not assemble the duct work with fasteners that extend into the duct. They will serve as a collection point for lint.

Duct joints can be made air and moisture-tight by wrapping the overlapped joints with duct tape.

INSULATION

Duct work which runs through an unheated area or is near an air conditioning duct, should be insulated to reduce condensation and lint build up and be sloped down toward outdoors.

NOTE: Never install screen inside exhaust duct.

WARNING: THIS MACHINE MUST BE EXHAUSTED OUTDOORS WHEN OPERATED IN THE VENTING MODE. THIS IS TO PREVENT LARGE AMOUNTS OF LINT AND MOISTURE FROM ACCUMULATING AND TO MAINTAIN DRYING EFFICIENCY.

ATTENTION: IN VENT DRY MODE, THE EXHAUST FAN AND EXHAUST DUCT SHOULD BE CLEANED ONCE A YEAR.

SPECIAL INSTALLATION REQUIREMENTS

MINIMUM CLEARANCE OTHER THAN ALCOVE OR CLOSET INSTALLATION

Minimum clearances to combustible surfaces: 2" (5 cm) clearance both sides and 3" (7.5 cm) rear.

BUILT-IN, RECESSED, CLOSET AND ALCOVE INSTALLATION

The Combo Washer-Dryer may be installed in a built-in, recessed area, closet or alcove.

The installation spacing is in inches and is the minimum acceptable.

Other installation must use the minimum dimension indicated.

Minimum clearance between dryer cabinet and adjustment walls are: 2" either side and 3" front and rear.

Minimum vertical space from floor to overhead cabinets, etc. is 52" (132 cm).

Closet door must be louvered or otherwise ventilated and must contain a minimum of 60 sq. in. of open area equally distributed. If this closet contains both washer and a dryer, doors must contain a minimum 120 sq. in. of open area equally distributed.

No other fuel-burning appliance shall be installed in the same closet with dryer.

- ★ Additional clearances for wall, door and floor molding may be required.
- ★ ★ Additional space is needed when an external exhaust elbow is used.

NOTE: If a door is installed that potentially encloses the unit while running, the door must allow for a minimum of 20 sq. in. of air free movement. There must also be a 1" additional space in front of the unit to the closed door and 1" from the back of the unit to the wall. Additional spacing should be considered for easy installation, servicing and compliance with all applicable local, state and federal codes.

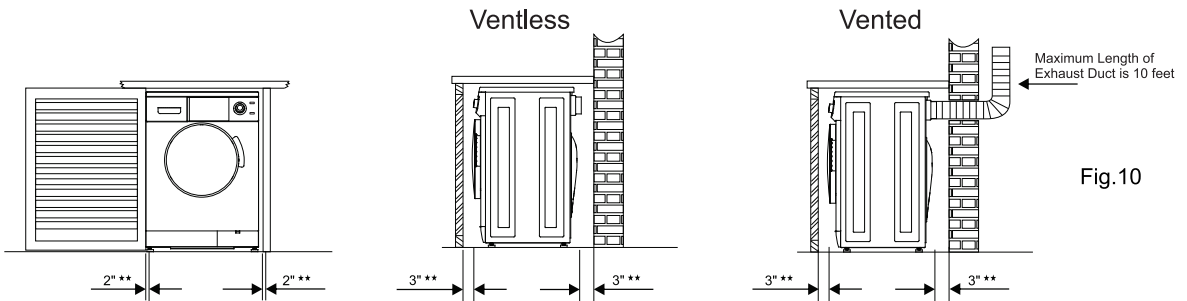

ADA COMPLIANCE

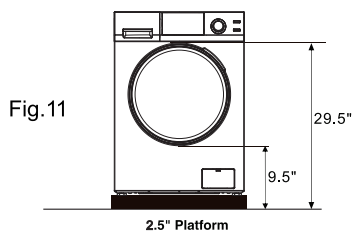

Use 2.5" height platform to make the machine ADA compliant.

PROGRAM SELECTION CHART

1. WASH & DRY, WASH ONLY, DRY ONLY

Wash Programs	Description of Load	Wash Features <small>Water Temp/Spin rpm/Duration</small>	Drying Heat & Approx Time
1. NORMAL	Mixed Clothes (Shirts, Trousers etc)	Warm / 1200 / 51 mins	Max heat - 1300W 90 mins
2. Prewash+Heavy	Thick cottons	Cold+Hot / 1400 / 75 mins	Max heat - 1300W 120 mins
3. Heavy	Cottons (Towels, Jeans etc)	Hot / 1400 / 61 mins	Max heat - 1300W 120 mins
4. ECO	Cottons Blends	Cold / 800 / 31 mins	Max heat - 1300W 80 mins
5. Quick 20	Light fabrics	Cold / 1200 / 20 mins	Max heat - 1300W 80 mins
6. Delicate	Silk, Polyester etc	Cold / 800 / 36 mins	Max heat - 750W 80 mins
7. Wool	Woolens	Cold / 500 / 36 mins	Tumble only NO HEAT
8. Quiet 60 dB	Mixed Cottons	Cold / 800 / 31 mins	Max heat - 1300W 80 mins
9. Allergen	Bed Sheets etc	Hot / 1200 / 59 mins	Max heat - 1300W 120 mins
10. Sanitize	Mixed Cottons	Hot / 1200 / 69 mins	Max heat - 1300W 120 mins

2. DRY CYCLES

Refresh Dry - 12 mins cycle blowing hot air onto the clothes before folding.

Time Dry 60 - 60 mins dry cycle.

3. OTHER CYCLES:

Rinse/Spin - 12 mins Spin cycle at 1000 RPM.

Winterize - 2 minute cycle to winterize your appliance. (follow procedure on page 18)

Self-Clean - 9 mins cycle at 90° to clean the inner drum and tub of the machine

OPERATING INSTRUCTIONS

1. Ensure the Combo Washer⊕Dryer is turned off. (Power Indicator light should be off).
2. Separate clothes by type, color and degree of soiling.
3. For small items such as socks, children's garments and small towels please use a **Washing Net Bag**.
4. Load clothes of the selected type loosely into the drum.
If you are using Wash Only cycle, you can fill the drum.
If you are using Wash + Dry cycle, please do not load clothes more than 2/3 full.
5. Close the Washer⊕Dryer door. You will hear a click when it is correctly closed.
Use Front Load detergent, as per direction.
Add detergent to Dispenser A.
You can add fabric softener in Dispenser B & pre-wash detergent and bleach in Dispenser C (Fig.12)

Detergent Dispenser

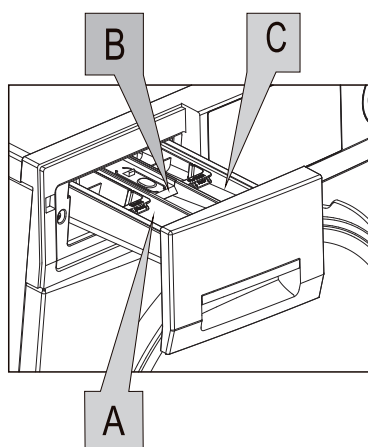

Dispenser A:
Detergent for main wash

Dispenser B:
Fabric softener

Dispenser C:
Detergent for pre-wash and bleach

**The blue cups are only for liquid detergent.
Please do not add powder in these cups.**

Note: concentrated fabric softener must be diluted with a little water before being poured into the dispenser
(This prevents the overflow siphon from getting blocked)

Fig.12

Your washer/combo is designed to use a high efficiency (HE) detergent, which reduces or eliminates suds and results in more efficient washing.



WINTERIZING



How to winterize for cold weather

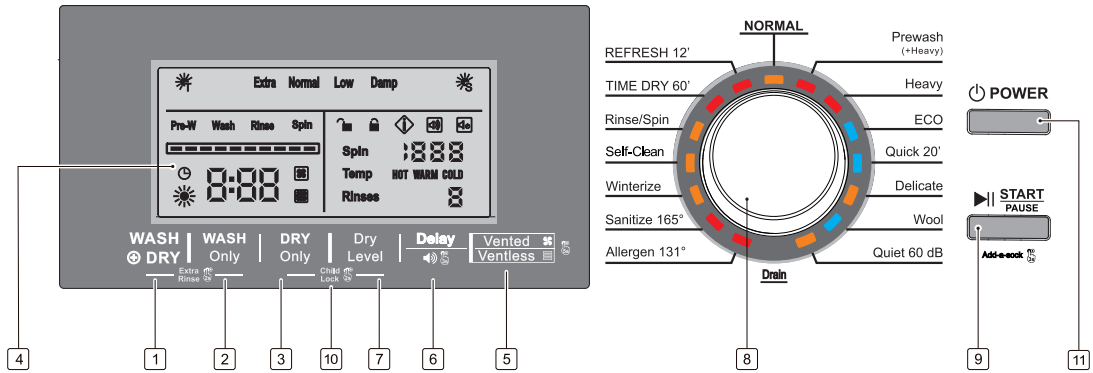

1. Pour 2 cups of RV type Antifreeze in soap dispenser.
2. Select WINTERIZE cycle on knob and press START. Machine will Rinse & Spin.
3. Open Coin trap once cycle is finished and drain out remaining water/antifreeze.
4. Shut off water at both faucets and disconnect water inlet hoses from faucets and drain.

Control Panel



Buttons Introduction

- 1 Wash ⊕ Dry To select Wash & Dry cycle together.
- 2 Wash Only To select Wash cycle only. For extra rinse, press and hold 1 + 2 together.
- 3 Dry Only To select Dry cycle only.
- 4 Color LED Display To display the selected program, such as the water selection, spin speed, remaining time, rinse times, water level and error messages. (See page 18 for details)
- 5 Vented / Ventless selection button Press this selection button for 5 seconds to select either the Vented dry mode or the Ventless dry mode. The default condition is the Ventless mode. The symbol  will be displayed if you are using the Ventless dry mode and symbol  will be displayed for Vented dry mode.
- 6 Delay and Chime (🔊) button To delay the start of the wash cycle, touch this button to select the delay time from 1 to 24 hours. Each time the Delay button is pressed, the time increases in one-hour increments. The delay time will show on the Display Panel. Then press Start and the cycle will start after the selected delay time has elapsed.

To turn the chime on  or chime off , wait until after the wash cycle has started and then press and hold the button for 5 seconds. The chime icon will illuminate showing the chime on or off selection.
- 7 Dry Level button Press this button to select the dry level for a Sensor Dry cycle. The default is Normal and you can select Extra, Low or Damp Dry.
- 8 Program Dial Turn the dial to point to one of the 13 programs depending on the load.
- 9 Start/Pause button Press this button to start or stop the selected wash program, or to view the program during a cycle.
- 10 Child Lock In order to deactivate function to the controls, to prevent altering cycle, press and hold Dry only and Dry level buttons for 5 seconds
- 11 Power Press this button to turn the machine on.

If a sensor dry cycle is selected, the symbol  will be displayed.

If a time dry cycle is selected, the symbol  will be displayed.

Display Panel Symbols

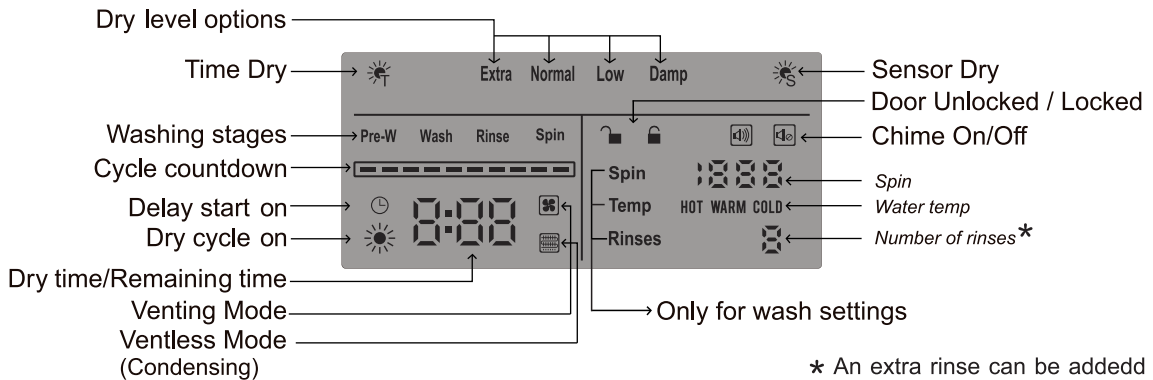

A. How to run WASH + DRY Cycle

1. Press POWER button
2. Press START

Default cycle is NORMAL - If required you can change to desired washing cycle based on type of clothes by rotating the Program Dial knob.

B. How to run WASH Only Cycle

1. Press POWER button
2. Press WASH Only button
3. Press START

Default cycle is NORMAL - If required you can change to desired washing cycle based on type of clothes by rotating the Program Dial knob.

C. How to run DRY Only Cycle

1. Press POWER button
2. Press DRY Only button
3. Press START

Default cycle is NORMAL and Sensor Dry - You can select Damp, Low or Extra for the desired dry level. You can also select Time Dry for 60 minutes.

4. At the end of the DRY cycle, if the clothes are not completely dry or if the clothes have been in the drum for some time, you can press the Refresh button to dry the clothes and prevent wrinkles.

Add-a-sock Feature

The wash program can be stopped at any time to add forgotten items to the laundry.

- Press START/PAUSE for 5 seconds.
- Door will open 2 mins after draining water so that it does not overflow.
- Load clothes. Close door.
- Press START The cycle will continue from the point it stopped

How to stop the wash cycle

- The wash program can be stopped at any time.
- Press START/PAUSE for 5 seconds
- Press POWER button for 3 seconds to turn off the machine



How to stop the dry cycle

- Press POWER button for 3 seconds to turn off the machine

How to turn on the display in energy saving mode?

- Machine display gets turned off automatically during operations to save energy.
- Press any button to turn on display during this energy saving mode

Understanding the door lock function

Pressing the start button  will lock the door  → . The wash cycle will start and will continue until the whole program is completed. The door will be locked and cannot be opened until 2 minutes after the wash cycle ends. Please do not try to force the door open. **Breakage of the door handle is not covered by warranty.**

In the drying cycles, the door can be opened when the symbol  displays on the screen.

USEFUL TIPS

Denim Alert:























Some overalls have straps with hooks that can damage the drum of your washing machine or other garments during the wash. To minimize the risk, place hooks in the pocket and fasten with safety pins.

Vacations: unplug the appliance:

It is recommended that you should unplug the machine from the socket and turn off the water supply. Leave the door ajar to allow air circulation to the drum and the door gasket area. This will prevent unpleasant odors.

UNDERSTANDING FABRIC CARE LABELS

The symbols on labels of your garments will help you in choosing the suitable wash program, the right temperature, wash cycles, and ironing methods. Please review the chart below.

Machine Wash Cycle	 Standard	 Permanent Press/ wrinkle resistant	 Delicate/ Gentle	 Hand wash	 Do not wash	 Do not wring
Water Temp.	 Hot (50°C/120°F)		 Warm (40°C/105°F)		 Cold/Cool (30°C/85°F)	
Tumble Dry	 Dry	 Normal/ Cotton Heavy Duty	 Permt Press/ wrinkle resistant	 Delicate/ Gentle	 Do not tumble dry	 Do not dry
Special Instructions	 Line dry/ Hang to dry	 Drip dry	 Dry flat	 In the shade		
Bleach Symbols	 Bleach		 No-chlorine bleach		 Do not bleach	

MAINTENANCE

Your Washer-Dryer has been designed to operate with easy maintenance.

Follow these simple maintenance procedures to obtain optimum performance:

1. Ensure that your machine was installed according to the correct installation procedures detailed in this Manual.
2. Do not use solvents either to clean the machine or to wash clothes.
3. Keep the inside of the detergent dispenser clean.

Cleaning the coin trap

- Switch off the Washer -Dryer
- Open the service flap. (bottom right corner) (Fig.13)
- Carefully unscrew the coin-trap cover. **Warning: Some residual water will flow out. (Approx. 1 Cup)** (Fig.14)
- Remove foreign objects/fluff from inside and clean the interior. (Fig.15)
- The pump impeller wheel is located behind the water filter, must be able to rotate. Remove detergent residue and fluff from the pump cover thread and pump housing.
- Insert the coin-trap cover and screw tight. (Fig.16)
- Insert and close the service flap.

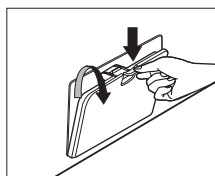

Fig.13

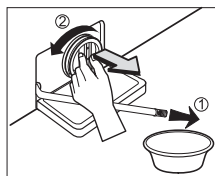

Fig.14

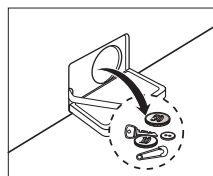

Fig.15

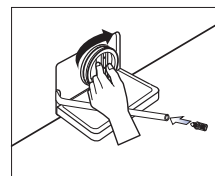

Fig.16

Cleaning the Detergent drawers and Recess

- Press release lever on the inside of the drawer and pull it out. (Fig.17)
- Remove the cap from the Fabric Softener compartment.
- Wash all of the parts under running water.
- Clean the drawer recess with a small brush. (Fig.18, Fig.19)
- Reinsert the cap (Pushing it firmly into place).
- Push the drawer back into place.
- Run a rinse program without any laundry in the drum.

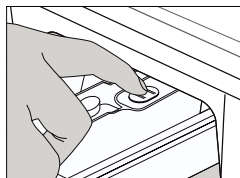

Fig.17

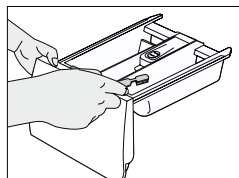

Fig.18

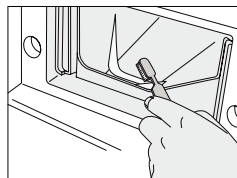

Fig.19

Cleaning the exhaust fan and duct

- If Vent Dry mode is used, clean the exhaust fan and exhaust duct at least once a year to prevent lint build-up.

STAIN REMOVAL CHART

Blood

Rinse or soak fresh stain in cold water. Work detergent into any remaining stain. Rinse. If stain persists, put a few drops of ammonia on stain and repeat detergent treatment. Rinse. If necessary bleach.

Burn Marks

Rinse or soak in cold water. Work detergent into stain. Rinse. Bleach, if necessary. Stain may be impossible to remove.

Candle Wax

Scrape off excess. Place stain between clean white blotters or several layers of facial tissues. Press with warm iron. Sponge with cleaning fluid. If dye spot remains, bleach.

Chewing Gum

Rub with ice to harden. Scrape off excess with dull blade. Sponge with cleaning fluid.

Chocolate or Cocoa

Soak 15 minutes in cold water. Rub detergent paste into stain, then rinse thoroughly. Launder in hottest water safe for fabric. If colored stain remains, sponge with hydrogen peroxide, rinse and launder.

Coffee or Tea

Soak fresh stains immediately in cold water. Then use bleach treatment with hottest water safe for fabric. Launder.

Cosmetics: eye shadow, lipstick, liquid make-up, mascara, powder, pancake make-up or rouge

Apply undiluted liquid detergent to stain, or dampen stain and rub in soap or detergent paste until thick suds are formed. Work in until stain is gone, rinse well. Repeat if necessary. If color remains, bleach if safe for fabrics.

Cream, Ice Cream or Milk

Sponge stain with cool water or soak stain in cool water for 30 minutes or longer. If stain remains, work detergent on spot then rinse. Bleach if necessary.

Deodorants and Antiperspirants

Wash or sponge stain thoroughly with warm water and detergent; rinse. If stain remains, bleach with hot sudsy water. Launder. You may be able to restore fabric color by sponging with ammonia. Rinse thoroughly.

Dye

Rinse or soak in cold water. Work detergent into stain. Rinse. If necessary, bleach. Stain is not always possible to remove. A commercial color remover may also be used.

Egg or Meat Juice

Rinse in cold water. If stain remains, sprinkle with meat tenderizer, let stand 15-20 minutes. If stain still remains, sponge with cleaning fluid or diluted bleach. Launder in hot water. The use of hot water first may set stain.

Fabric Softener Stain

Rub with bar soap until stain has lightened. Rinse thoroughly. Launder. Rubbing alcohol is sometimes effective in the color of the garment can take it. Launder. If desired, dry cleaning can be used.

Felt tip pen

Spray spot with cleaners suitable to this purpose. Sponge stain thoroughly. Rinse with cold water. Reapply cleaner if necessary.

Fruit, Wine

Soak fresh stains immediately with cool water. Then use bleach treatment with hottest water safe for fabrics. Launder.

Grass

Work detergent into stain. Sponge with denatured alcohol. Bleach, if necessary.

Grease or Oil

Scrape away excess. Rub detergent paste or a general purpose liquid household cleaner into stain, rinse with hot water. If stain remains, sponge thoroughly with a grease solvent. Dry. Repeat if necessary. To remove yellow stain, use a chlorine or oxygen bleach.

Ink

Some ball-point inks are set by water. First test a scrap of cloth. Sponge stain repeatedly with acetone, amyl acetate or rubbing alcohol. Hair spray is effective. Launder. Bleach if necessary. Use amyl acetate on triacetate, arnel, dynel and verel. Use acetone on other fabrics. NOTE: Some inks cannot be removed.

Ketchup

Scrape of excess. Soak in cold water 30 minutes. Pre-treat with a detergent paste. Launder.

Mildew

Brush off surface growth to keep mold spores from spreading. Dip article into solution of ½ cup bleach per 1 gallon (~3.8 Litres) of cool sudsy water for 5 to 10 minutes. Rinse well. Launder.

Mud

Let stain dry; then brush well. Rinse repeatedly in cool water until mud comes out. Launder. (Hot soaps suds set a red or yellow clay stain).

Mustard

Soak in hot detergent water for several hours. If stain remains, bleach.

Nail Polish

Treat while fresh, scraping or wiping off as much as possible, before it dries. Place stain face down on white paper towels. Sponge back of stain acetone (nail polish remover) or sponge with denatured alcohol and a few drops of household ammonia. Sponge stain frequently. Launder with water at temperature suitable for fabric. *Do not use acetone on acetate, arnel, dynel or rayon.*

Paint

Sponge or soak in turpentine or solvent recommended as a thinner on label. Launder.

Perfume

Rinse in cold water. Rub undiluted liquid detergent or a detergent paste into stain. Rinse. If stain remains, bleach.

Perspiration

Wash or sponge stain thoroughly with warm water and detergent paste. If perspiration has changed the color of the fabric, restore it by treating with ammonia or vinegar. Apply ammonia to fresh stains; rinse with water. Apply vinegar to old stains; rinse with water.

Rust and Iron

Apply commercial rust remover, Rinse. Or, if safe for fabric, boil stained article in solution of 4 teaspoons of cream of tartar to 2 cups of water.

Shoe Polish

Scrape off as much as possible. Pre-treat with a detergent paste; rinse. If stain persists, sponge with rubbing alcohol (1 part to 2 parts water) or turpentine. Remove turpentine by sponging again with warm detergent solution or with alcohol. Bleach if necessary.

Soft Drinks

Sponge with cold water, some stains are invisible when they have dried, but turn brown when heated and may be impossible to remove.

Tar and Asphalt

Act quickly before stain is dry. Sponge with grease solvent or turpentine. Launder.

Urine

Soak in cool water. If stain is dry, work a detergent paste into the spot then rinse. If necessary, bleach.

TROUBLESHOOTING

In most cases, when your Washer⊕Dryer fails to work, the problems arising can be easily solved without having to call for a technician. Before calling for assistance, always check these points.

Does not start

- Plug correctly inserted into the socket?
- Electricity in the house?
- Door closed properly?
- Start button pressed?
- Power button pressed?
- Washer knob in the correct position for the cycle to start?
- Do any other devices work on that particular socket?

Does not fill with water

- Hose correctly connected to the faucet?
- Water supply turned on?
- Sufficient water pressure?
- Faucet filter clean?
- Inlet hose kinked?

Continuously fills and drains water

- Is the drain hose positioned too low?
- Check that the inlet hose is not connected at a height more than 4" above the floor.

Does not drain or spin

- Does selected program incorporate water draining?
- Drain pump clogged?
- Drain hose kinked?
- Coin trap clean?

There are too many suds in the drum

- Is Front loading detergent being used? It is recommended to use Front Load detergent
- Is the correct amount of detergent being used?

Vibrates during the spin cycle

- Have all shipping bolts been removed during installation?
- Machine levelled correctly?
- Is there enough space between the machine and adjacent units?
- Is the machine loaded evenly?
- Is the machine installed on carpet or on a wooden floor?

Leaks

- Is the metal ring of the inlet hose properly attached?
- Is the detergent dispenser obstructed?
- Is the drain hose inserted correctly into the drain?

Not drying

- Is the dryer button correctly pressed for the drying cycle?
- Is drying cycle selected (Time Dry/Sensor Dry)?

Not drying efficiently

- Is the end of the drain hose under water?
- Is the drain pump obstructed?
- Is the drum overloaded?
- Is the cold water faucet open?
- Is fabric softener being used?

Condensation at soap dispenser

- Slight condensation can occur at soap dispenser and will evaporate. This is normal.

DIAGNOSTIC MENU

DIAGNOSTIC MENU		
Code	Description	Component
E1	Door open	Door Switch
E2	Drain failure	Drain Pump
E3	Water inlet failure	Inlet Valves
E4	Water overfill	Pressure Switch
E5	Motor failure	Motor +Electronic Module
E7	Washing heater failure	Washing heater
E8	Dryer Malfunction	Temp. sensor (@rear-bottom of tub)
E9	Dryer Malfunction	Temp. sensor (@front of heater housing)
E10	Water level failure	Water level sensor
E11	Dryer Malfunction	Temp. sensor (near the blow fan motor)
E12	Dryer Malfunction	Fan Motor
E13	Dryer Malfunction	Drying heater
E16	Communication between display & electronic module	Communication Cable

To Order parts : www.ApplianceDesk.com/Parts

