

Use & Care Manual

Laundry Center

EN 2

Manuel d'utilisation et d'entretien

Centre de buanderie

FR 79

Manual de uso y cuidado

Centro de lavado

SP 157



electrolux.com

 **Electrolux**

2

IMPORTANT SAFETY INFORMATION

Please Read and Save this Manual

Thank you for choosing Electrolux, our premium brand in home appliances. This *Use & Care Manual* is part of our commitment to customer satisfaction and product quality throughout the service life of your new appliance.

We view your purchase as the beginning of a relationship. To ensure our ability to continue serving you, please use this page to record important product information.

Keep a Record for Quick Reference

Purchase date

Electrolux serial number

Electrolux model number

Electrolux model series*

**The series number can be found within the Model number (example ELTE7600AW=7600 series).*

NOTE

Registering your product with Electrolux enhances our ability to serve you. You can register on-line at www.electrolux.com, by sending your Product Registration Card in the mail, or PHOTOREGISTERSM using a smart phone. See registration card for details.

Table of Contents

Important Safety Information	2
Features	9
Pre-Installation Requirements	10
Installation.....	21
Washer Controls and Settings.....	40
Dryer Controls and Settings.....	48
Washer Operating Instructions	54
Dryer Operating Instructions	58
Normal Operating Sounds	60
Stain Removal Guide.....	61
Care and Cleaning	63
Troubleshooting	68
Limited Warranty.....	77

Questions?

For toll free telephone support or on-line support in the US and Canada contact:

U.S.

1-877-4ELECTROLUX (1-877-435-3287)
www.electrolux.com

Canada

1-800-265-8352
www.electrolux.ca

**READ ALL INSTRUCTIONS BEFORE
OPERATING THIS LAUNDRY
CENTER.**

**SAVE THESE INSTRUCTIONS FOR
FUTURE REFERENCE.**

IMPORTANT SAFETY INSTRUCTIONS - GAS DRYER

 **WARNING****FIRE or explosion hazard**

Failure to follow safety warnings exactly could result in serious injury, death, or property damage.

DO NOT store or use gasoline or other flammable vapors and liquids in the vicinity of this or any other appliance.

WHAT TO DO IF YOU SMELL GAS:

- **DO NOT try to light any appliance.**
- **DO NOT touch any electrical switch; DO NOT use any phone in your building.**
- **Clear the room, building or area of all occupants.**
- **Immediately call your gas supplier from a neighbor's phone. Follow the gas supplier's instructions.**
- **If you cannot reach your gas supplier, call the fire department.**

Installation and service must be performed by a qualified installer, service agency or the gas supplier.

 **DANGER**

If using Liquid Propane (LP), STOP and install the LP kit before operating your gas dryer.



WARNING

RISK OF FIRE

- **Ensure the entire laundry center exhaust system is clean and free of lint and debris prior to the installation of your new laundry center. The entire exhaust system should be inspected and cleaned a minimum of every 18 months with normal usage. Failure to comply with cleaning your exhaust system will increase the RISK of FIRE.**
- DO NOT install the laundry center with flexible plastic or flexible foil venting material. Flexible venting materials are known to collapse, be easily crushed and trap lint. These conditions will obstruct laundry center airflow and increase the risk of fire.
- DO NOT screen the exhaust ends of the vent system, or use any screws, rivets or other fasteners that extend into the duct to assemble the exhaust system. NO screen or grate of any mesh size is allowed to cover the outdoor exhaust opening.
- Install the laundry center according to the manufacturer's instructions and local codes.
- Laundry center installation and service must be performed by a qualified installer, service agency or the gas supplier.
- The electrical service to the laundry center must conform with local codes and ordinances and the latest edition of the National Electrical Code, ANSI/NFPA 70, or in Canada, the Canadian Electrical Code CSA C22.1 part 1.
- The gas service to the laundry center must conform with local codes and ordinances and the latest edition of the National Fuel Gas Code ANSI Z223.1/NFPA 54, or in Canada, the Natural Gas and Propane Installation Code, CSA B149.1. An individual manual shutoff valve must be installed within 6 ft (1.83 m) of the laundry center in accordance with the National Fuel Gas Code, ANSI Z223.1/NFPA 54.
- The laundry center is designed under ANSI Z21.5.1/CSA 7.1 or UL 2158 - CAN/CSA C22.2 No. 112 (latest editions) for HOME USE only. This laundry center is not recommended for commercial applications such as restaurants, beauty salons, etc.
- Destroy the carton and plastic bags after the laundry center is unpacked. Children might use them to play. Cartons covered with rugs, bedspreads, or plastic sheets can become airtight chambers causing suffocation. Place all materials in a garbage container or make materials inaccessible to children.
- To reduce the risk of severe injury or death, follow all installation instructions in this manual.



WARNING

For your safety, the information in this manual must be followed to minimize the risk of fire or explosion or to prevent property damage, personal injury or loss of life. DO NOT store or use gasoline or other flammable vapors and liquids in the vicinity of this or any other appliance. This *Use & Care Manual* is not meant to cover every possible condition and situation that may occur. Common sense and caution must be practiced when installing, operating and maintaining any appliance.



WARNING

Any damage resulting from improper disassembly/assembly or installation of product is not covered by product warranty.

Important Safety Instructions

Safety Precautions

DO NOT attempt to install or operate your unit until you have read the safety precautions in this manual. Safety items throughout this manual are labeled with a Danger, Warning, or Caution based on the risk type.

Definitions

 This is the safety alert symbol. It is used to alert you to potential personal injury hazards. Obey all safety messages that follow this symbol to avoid possible injury or death.



DANGER

DANGER indicates an imminently hazardous situation which, if not avoided, will result in death or serious injury.



CAUTION

CAUTION indicates a potentially hazardous situation which, if not avoided, may result in minor or moderate injury.



WARNING

WARNING indicates a potentially hazardous situation which, if not avoided, could result in death or serious injury.



IMPORTANT

IMPORTANT indicates installation, operation or maintenance information which is important but not hazard-related.



WARNING

FIRE HAZARD

To reduce the risk of fire, electrical shock, or injury to persons when using this laundry center, comply with the warnings listed below. Failure to comply with these Important Safety Information and warnings could result in property damage, serious personal injury, or death.

Prevent Fire

- READ ALL INSTRUCTIONS BEFORE USING THE APPLIANCE.
- DO NOT wash or dry items that have been previously cleaned in, soaked in, or spotted with gasoline, cleaning solvents, kerosene, waxes, or other flammable or explosive substances. DO NOT store these items on or near the laundry center. These substances give off vapors that could ignite or explode.
- DO NOT place items exposed to cooking oils in your dryer. Items contaminated with cooking oils may contribute to a chemical reaction that could cause a load to catch fire. To reduce the risk of fire due to contaminated loads, the final part of a tumble dryer cycle occurs without heat (cool down period). Avoid stopping a tumble dryer before the end of the drying cycle unless all items are quickly removed and spread out so that the heat is dissipated.
- DO NOT dry articles containing rubber, plastic or similar materials such as bras, galoshes, bath mats, rugs, bibs, baby pants, plastic bags and pillows that may melt or burn. Some rubber materials, when heated, can under certain circumstances produce fire by spontaneous combustion.
- DO NOT operate the dryer if the lint screen is blocked, damaged or missing. Fire hazard, overheating and damage to fabrics can occur.
- DO NOT obstruct the flow of ventilating air. DO NOT stack or place laundry or throw rugs against the front or back of the laundry center.
- DO NOT spray any type of aerosol into, on or near laundry center at any time.
- DO NOT use fabric softeners or products to eliminate static unless recommended by the manufacturer of the fabric softener or product.

**WARNING****FIRE HAZARD**

Clean the lint screen before or after each load. **The interior of the dryer, lint screen housing and exhaust duct should be cleaned approximately every 18 months by qualified service professional.** An excessive amount of lint build-up in these areas could result in inefficient drying and possible fire. See *Care and Cleaning*.

**WARNING****FIRE HAZARD**

The dryer operation of a laundry center produces combustible lint. The dryer must be connected to an outdoor exhaust. Regularly inspect the outdoor exhaust opening and remove any accumulation of dust, dirt, and lint around the opening and in the surrounding area.

**WARNING**

DO NOT continue to use the laundry center if you hear squeaking, grinding, rubbing or other unusual noises. This could be a sign of mechanical breakdown and lead to fire or serious injury. **Contact a qualified technician immediately.**

- Do not wash items that have been previously cleaned in, soaked in, or spotted with gasoline, cleaning solvents, kerosene, cooking oils, waxes, or other flammable or explosive substances. Do not store these items on or near the washer. These substances give off vapors or chemical reactions that could ignite or explode.
- DO NOT put oily or greasy rags or clothing on top of the washer. These substances give off vapors that could ignite the materials.
- DO NOT add gasoline, cleaning solvents, or other flammable or explosive substances to the wash water. These substances give off vapors that could ignite or explode.
- DO NOT store or use gasoline or other flammable vapors or liquids in the

vicinity of this or any other appliance.

- Under certain conditions, hydrogen gas may be produced in a hot water system that has not been used for 2 weeks or more. HYDROGEN GAS IS EXPLOSIVE. If the hot water system has not been used for such a period, before using the washer, turn on all hot water faucets and let the water flow from each for several minutes. This will release any accumulated hydrogen gas. Hydrogen gas is flammable; DO NOT smoke or use an open flame during this time.

Failure to comply with these warnings could result in fire, explosion, serious bodily injury and/or damage to the laundry center

Protect Children

- Risk of suffocation and injury from entrapment. Do not allow children to play on or in the laundry center. Close supervision of children is necessary when the laundry center is used. As children grow, teach them the proper, safe use of all appliances.
- Destroy the carton, plastic bag and other packing materials after the laundry center is unpacked. Children might use them for play. Cartons covered with rugs, bedspreads or plastic sheets can become airtight compartments.
- Keep laundry products out of children's reach. To prevent personal injury, observe all warnings on product labels.
- Remove the laundry center doors to prevent accidental entrapment before the laundry center is removed from service or discarded.
- Failure to comply with these warnings could result in serious personal injuries.

Risk of Child Entrapment

Child entrapment and suffocation are not problems of the past. Junked or abandoned laundry centers are still dangerous – even if they will sit for “just a few days”. If you are getting rid of your old laundry center, please follow the instructions below to help prevent accidents.

We strongly encourage responsible appliance recycling/disposal methods. Contact your State/Province Energy Office, Local Electric and Water Utilities or Conservation Program Office or visit www.energystar.gov/recycle for more information on recycling your old laundry center.

Before You Throw away Your Old Laundry Center

- Remove doors
- Remove the electric power cord
- Secure all hoses and drain pipes to prevent water from leaking out and creating a slip hazard.

Prevent Injury

- To prevent shock hazard and assure stability during operation, the laundry center must be installed and electrically grounded by a qualified service person in accordance with local codes. Installation instructions are included in this manual for reference. Refer to the *installation sections* for detailed grounding procedures. If the laundry center is moved to a new location, have it checked and reinstalled by a qualified service professional.
- To prevent personal injury or damage to the laundry center, the electrical power cord of a gas dryer must be plugged into a properly grounded and polarized 3-prong outlet. The third grounding prong must never be removed. Never ground the dryer to a gas pipe. DO NOT use an extension cord or an adapter plug.
- To prevent personal injury or damage to the washer, the electrical power cord of the washer must be plugged into a properly grounded and polarized 3-prong outlet. The third grounding prong must never be removed. Never ground the washer to a gas pipe. DO NOT use an extension cord or an adapter plug.
- DO NOT use any type of spray cleanser when cleaning laundry center interior. Hazardous fumes or electrical shock could occur.
- To prevent injury, DO NOT reach into the washer or dryer if the drum is moving. Wait until the dryer has stopped completely before reaching into the drum.
- Do not operate either the washer or dryer if they are separated from one another.

Prevent Injury and Damage to the Laundry Center

To prevent serious personal injury and damage to the laundry center:

- All repairs and servicing must be performed by an authorized service provider unless specifically recommended in this use and care manual. Use only authorized factory parts. Do not separate the dryer from the washer if you are not a qualified service professional.
- DO NOT tamper with controls.
- DO NOT sit on, step on or stand on the laundry center. DO NOT rest heavy loads on top. The laundry center is not meant to support weight.
- DO NOT install or store the laundry center where it will be exposed to standing water, dripping water or outdoor weather conditions.
- Thermal limiter switches automatically turn off the motor in the unlikely event of an overheated situation. A service technician must replace the thermal limiter switch(es) after correcting the fault.
- DO NOT install on carpet. Install laundry center on a solid floor. It may be necessary to reinforce the floor to prevent vibration or movement.
- To reduce the risk of electric shock, disconnect this appliance from the power supply before attempting any user maintenance. Pressing the power button does not disconnect this appliance from the power supply.
- This laundry center is equipped with an electrical overload protector which will stop the motor if it becomes overheated.
- Do not use replacement parts that have not been recommended by the manufacture (e.g. parts made at home using a 3D printer).
- Failure to comply with these warnings could result in serious personal injuries.

**CAUTION**

Do not, under any circumstances, cut, remove, or bypass the grounding prong.

208/240V Electric Dryer

1. 10-30R 3-wire (fused 30 amp)
2. 14-30R 4-wire (fused 30 amp)

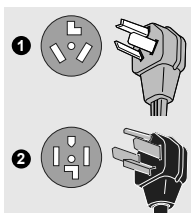
**NOTE**

UL - approved service cord must be installed on electric dryers (not provided with unit except those manufactured for sale in Canada).

120V Gas Dryer

1. Power cord with grounded prong.

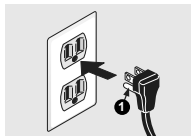
**WARNING**

Improper grounding of the washer may cause serious injury or death. Check with a licensed electrician if you are in doubt as to whether the appliance is properly grounded.

- Follow package directions when using laundry products. Incorrect usage can produce poisonous gas - resulting in serious injury or death.
- DO NOT combine laundry products for use in 1 load unless specified on the label.

**WARNING****ELECTRICAL SHOCK HAZARD**

This equipment has two connections to the power supply. Disconnect both power supply connections before servicing. Each appliance shall be connected to an individual branch circuit only. The washer and dryer must be on separate circuits.

**WARNING****HARMFUL VAPOR HAZARD**

DO NOT use or mix liquid chlorine bleach with other household chemicals such as toilet cleaners, rust removers, acids such as vinegar, or products containing ammonia. These mixtures can produce dangerous fumes which can cause serious injury or death.

**WARNING****RISK OF INJURY**

DO NOT WASH: Water resistant and water repellent clothing or other materials. Failure to follow these instructions may result in an abnormal vibrating and out-of-balance condition that could result in physical injury, property damage, and/or appliance damage.



Installation Checklist

Shipping Hardware

- Foam shipping support (under wash tub) removed and stored
- Shipping bolts and spacers removed from rear of appliance and stored
- Hole plugs (shipped in manual bag) installed in holes in backsheet

Leveling

- Washer is level, side-to-side and front-to-back
- Cabinet is sitting solid on all corners

Water Supply

- Use only new hoses and verify rubber sealing washers are installed
- HOT supply is connected to HOT inlet and COLD supply is connected to COLD inlet
- HOT and COLD water supply turned on
- No leaks present at water supply connections or appliance inlet connections - recheck in 24 hours

Drain

- Stand pipe or wall drain height minimum 24"
- Verify anti-siphon disc is attached toward end of drain hose
- Drain hose secured in place with cable tie (shipped in drum)

Exhaust Venting

- Free-flowing, clear of lint buildup
- 4 inch (102 mm) rigid metal or semi-rigid metal transition ducting of minimal length and turns
- NO foil or plastic venting material
- Approved vent hood exhausted to outdoors

Door Reversal

- Follow detailed instructions in this manual
- Test hinge and latch for function

Gas Supply (Gas Dryer)

- Manual shutoff valve present in supply
- All connections sealed with approved sealer and wrench tight
- Conversion kit for LP GAS system # PCK4200 (not included) and must be purchased separately
- Gas supply turned on
- No leaks present at all connections - check with soapy water, NEVER check with flame

240v Electric Supply (Electric Dryer)

- Approved NEMA 10-30 or 14-30 service cord with all screws tight on terminal block
- Approved strain relief installed
- Terminal access cover installed before initial operation

Water Hookup (Select Models)

- Inspect hoses for proper placement of rubber washers
- Water supply is turned on
- Check for leaks
- Steam model dryers require use of ASSEMBLY HOSE Kit #5304495002 (not included) and must be purchased separately.



















Electrical Power

- House power turned on
- Washer plugged in
- Dryer plugged in

Final Checks

- Installation instructions and Use & Care Manual read thoroughly
- Door locks and water enters drum when cycle starts
- Washer door latches and drum tumbles when cycle starts
- Dryer door latches and drum tumbles when cycle starts
- Registration card sent in

Tools and Materials Needed for Installation:

	1. Adjustable Wrench OR		7. Flat or Louvered External Vent Hood
	3/8" or 10 mm box wrench OR		8. 3 or 4 wire 240 volt cord kit (Electric Laundry center) OR
	Ratchet and Socket set		9. 4 in. rigid metal exhaust duct work OR
	2. Adjustable Pliers		4 in. semi-rigid metal exhaust duct work
	3. Carpenter's Level		10. 4 in. (10.2 cm) clamp
	4. Phillips, Flat, & Square Bit Screwdrivers		11. Gas Line Shutoff Valve (Gas Laundry center)
	5. Pipe Wrench for gas supply		12. 1/2" NPT union flare adapters (x2)
	6. LP Resistant Sealant OR		13. Flexible gas supply line (Gas laundry center)
	LP Resistant Thread Tape		14. Metal foil tape (not duct tape)

Replacement Parts in U.S. and Canada:

If replacements parts are needed for your washer, you can contact the source where you purchased your washer, call 1-877-4ELECTROLUX (1-877-435-3287) in the U.S. or 1-800-265-8352 in Canada, or visit our website, www.electrolux.com in the U.S. or www.electrolux.ca in Canada for the Electrolux Authorized Parts Distributor nearest you.

Accessories



CAUTION

Do not attempt to use a pedestal with this laundry center. Failure to use accessories manufactured by (or approved by) the manufacturer could result in personal injury, property damage or damage to the laundry center.

LP CONVERSION KIT P/N PCK4200

Gas laundry centers intended for use in a location supplied with LP must use a conversion kit prior to installation.

UNIVERSAL APPLIANCE WRENCH P/N 137019200

A Universal Appliance Wrench is available to aid in laundry center/washer/pedestal feet adjustment.



TOUCH UP PAINT PENS* Classic White Touch Up Pen - P/N 5304468812



NOTE

Hoses are not included with washer purchase.

ASSEMBLY HOSE KIT P/N 5304495002

For use in laundry center models that include a steam feature.

INLET HOSE KITS

Please call 866-233-8353 (in Canada, 800-265-8352) to explore

hose kit options that will meet your specific installation needs.



Inlet hose x2

DRAIN HOSE EXTENSION KIT P/N 137098000

In order to reach standpipe heights or distances beyond the reach of the drain hose supplied, order the Drain Hose Extension Kit

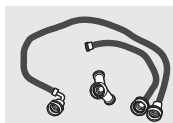

Electrical System Requirements

NOTE

Because of potentially inconsistent voltage capabilities, the use of this laundry center with power created by gas powered generators, solar powered generators, wind powered generators or any other generator other than the local utility company is not recommended.

Electrical Requirements for Electric Dryer:

CIRCUIT - Individual 30 amp. branch circuit fused with 30 amp. time delay fuses or circuit breakers. Use separately fused circuits for washer and dryer. **DO NOT** operate washer and dryer on same circuit

POWER SUPPLY - 3-wire or 4-wire, 120/240 volt, single phase, 60 Hz, Alternating Current



WARNING

FIRE HAZARD

- Failure to follow safety warnings exactly could result in serious injury, death, or property damage.
- **DO NOT** install a booster fan in dryer exhaust duct
- Install all laundry centers in accordance with the installation instructions in this manual.

NOTE

A 120/208 volt, single phase, 60 Hz, Alternating Current supply may be used on dryers marked for use on rating plate.

NOTE

The electric laundry center has been designed and certified to operate at both 240V and 208V. Drying times on a 208V power supply will, however, be approximately 20% longer than drying times on a 240V power supply. This is normal and expected behavior and applies to all drying cycles.



IMPORTANT

The laundry center is internally grounded to neutral unless it was manufactured for sale in Canada.

Only a 4-conductor cord shall be used when the appliance is installed in a location where grounding through the neutral conductor is prohibited. Grounding through the neutral link is prohibited for: (1) new branch circuit installations, (2) mobile homes, (3) recreational vehicles, and (4) areas where local codes **DO NOT** permit grounding through the neutral.

3-wire Power Supply Cord (not supplied)



3-wire receptacle (NEMA type 10-30R)

The dryer **MUST** employ a 3-conductor power supply cord NEMA 10-30 type SRDT rated at 240 volt AC minimum, 30 amp, with 3 open end spade lug connectors with upturned ends or closed loop connectors and marked for use with clothes dryers. For 3-wire cord connection instructions see "Electrical connection (non-Canada) - 3-wire cord" in Electrical Installation section.

OUTLET RECEPTACLE - NEMA 10-30R receptacle to be located so the power supply cord is accessible when the laundry center is in the installed position.

GROUNDING CONNECTION - See "Grounding requirements" in Electrical Installation section.

4-wire Power Supply Cord (not supplied)



4-wire receptacle (NEMA type 14-30R)

The dryer **MUST** employ a 4-conductor power supply cord NEMA 14-30 type SRDT or DRT (as required) rated at 240 volt AC minimum, 30 amp, with 4 open end spade lug connectors with upturned ends or closed loop connectors and marked for use with clothes dryers. For 4-wire cord connection instructions see "Electrical connection (non-Canada) - 4-wire cord" in Electrical Installation section.



NOTE

Laundry centers manufactured for sale in Canada have factory-installed, 4-wire power supply cord (NEMA 14-30).

OUTLET RECEPTACLE - NEMA 14-30R receptacle to be located so the power supply cord is accessible when the laundry center is in the installed position.

GROUNDING CONNECTION - See "Grounding requirements" in Electrical Installation section.

Electrical Requirements for Gas Dryer:

CIRCUIT - Individual, properly polarized and grounded 15 amp. branch circuit fused with 15 amp. time delay fuse or circuit breaker.

POWER SUPPLY - 2-wire, with ground, 120 volt, single phase, 60 Hz, Alternating Current

POWER SUPPLY CORD - Dryer is equipped with 120 volt 3-wire power cord.

GROUNDING CONNECTION - See "Grounding requirements" in Electrical Installation section.



WARNING

Improper grounding of the laundry center may cause serious injury or death. Check with a licensed electrician if you are in doubt as to whether the appliance is properly grounded.



CAUTION

Do not, under any circumstances, cut, remove, or bypass the grounding prong.

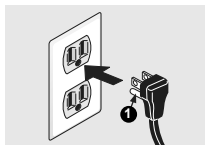

1. Power cord with grounded prong.

Gas Supply Requirements



WARNING

EXPLOSION HAZARD

Uncoated copper tubing will corrode when subjected to natural gas, causing gas leaks. Use **ONLY** black iron, stainless steel, or plastic-coated brass piping for gas supply.

1. The gas service to the laundry center must conform with local codes and ordinances and the latest edition of the National Fuel Gas Code ANSI Z223.1/ NFPA 54, or in Canada, the Natural Gas and Propane Installation Code, CSA B149.1.
2. The gas supply line should be 1/2 inch (1.27 cm) pipe.
3. If codes allow, flexible metal tubing may be used to connect your laundry center to the gas supply line. The tubing **MUST** be constructed of stainless steel or plastic-coated brass.
4. The gas supply line **MUST** have an individual shutoff valve installed in accordance with the B149.1, Natural Gas and Propane Installation Code.
5. A 1/8 inch (0.32 cm) N.P.T. plugged tapping, accessible for test gauge connection, **MUST** be installed immediately upstream of the gas supply connection to the laundry center.
6. The laundry center **MUST** be disconnected from the gas supply piping system during any pressure testing of the gas supply piping system at test pressures in excess of 1/2 psig (3.45 kPa).
7. The laundry center **MUST** be isolated from the gas supply piping system during any pressure testing of the gas supply piping system at test pressures equal to or less than 1/2 psig (3.45 kPa).
8. Connections for the gas supply must comply with the Standard for Connectors for Gas Appliances, ANSI Z21.24/CSA 6.10.

Electrical System Requirements for Washer

CIRCUIT - Individual, properly polarized and grounded 15 amp. branch circuit fused with 15 amp. time delay fuse or circuit breaker.

POWER SUPPLY - 2 wire, with ground, 120 volt single phase, 60 Hz, Alternating Current.

OUTLET RECEPTACLE - Properly grounded 3-prong receptacle to be located so the power supply cord is accessible when the washer is in an installed position.



WARNING

ELECTRIC SHOCK HAZARD

Certain internal parts are intentionally not grounded and may present a risk of electrical shock if contacted during installation. Do not contact the following parts while the appliance is energized.

- Pump
- Drive motor
- Electrical control boards
- Water valves



WARNING

ELECTRICAL SHOCK HAZARD

Improper connection of the equipment grounding conductor can result in a risk of electrical shock. Check with a licensed electrician if you are in doubt as to whether the appliance is properly grounded.



CAUTION

Do not, under any circumstances, cut, remove, or bypass the grounding prong.

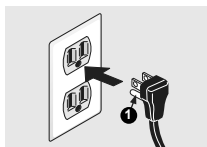

1. Power cord with grounded prong.

Grounding requirements

1. The washer **MUST** be grounded. In the event of malfunction or breakdown, grounding will reduce the risk of electrical shock by a path of least resistance for electrical current.
2. Since your washer is equipped with a power supply cord having an equipment-grounding conductor and a grounding plug, the plug **MUST** be plugged into an appropriate, copper wired receptacle that is properly installed and grounded in accordance with all local codes and ordinances or in the absence of local codes, with the National Electrical Code, ANSI/NFPA 70 (latest edition), or in Canada, the Canadian electrical code C22.1 part 1. If in doubt, call a licensed electrician. **DO NOT** cut off or alter the grounding prong on the power supply cord. In situations where a two-slot receptacle is present, it is the owner's responsibility to have a licensed electrician replace it with a properly grounded three prong grounding type receptacle.

Water Supply Requirements

Hot and cold water faucets **MUST** be installed within hose length of your washer's water inlet. The faucets **MUST** be 3/4 inch (1.9 cm) with threading for laundry hose connection. Water pressure **MUST** be between 20 and 120 psi. Pressure difference between hot and cold cannot be more than 10 psi. Your water department can advise you of your water pressure.

Drain System Requirements

1. Drain capable of eliminating 17 gallons (64.3 L) per minute.
2. A standpipe diameter of 1-1/4 in. (3.18 cm) minimum.
3. The standpipe height above the floor :
Minimum height: 24 in. (61 cm)
Maximum height: 96 in. (244 cm).

PRE-INSTALLATION REQUIREMENTS

 **NOTE**

Drain hose length is 59 in. (150 cm). For installations requiring a longer drain hose, use hose P/N 137098000, available from an authorized parts distributor.

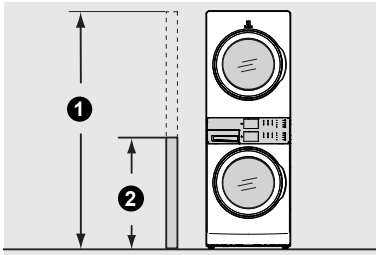

1. 96" (244cm) max.
2. 24" (61 cm) min.

 **NOTE**

For installations requiring a longer drain hose, have a qualified technician install a longer drain hose (according to your model number) available from an authorized parts distributor. For drain systems in the floor, install a siphon break kit available from your local hardware store.

Exhaust System Requirements**Duct Work Requirements**

Use only 4 inch (102 mm) diameter rigid or flexible metal duct and approved vent hood which has a swing-out damper(s) that open when the dryer is in operation. When the dryer stops, the dampers automatically close to prevent drafts and the entrance of insects and rodents. To avoid restricting the outlet, maintain a minimum of 12 inches (30.5 cm) clearance between the vent hood and the ground or any other obstruction.

 **WARNING**
FIRE HAZARD

Failure to follow these instructions can create excessive drying times and fire hazards.

The following are specific requirements for proper and safe operation of your laundry center.

 **WARNING**
FIRE HAZARD

DO NOT install a laundry center with flexible plastic or metal foil venting materials. Flexible venting materials are known to collapse, be easily crushed and trap lint. These conditions will obstruct laundry center airflow and increase the risk of fire.

If your present system is made up of plastic duct or metal foil duct, replace it with a rigid or semi-rigid metal duct. Also, ensure the present duct is free of any lint prior to installing dryer duct.

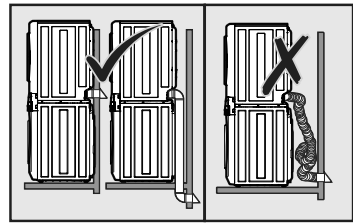
 **WARNING**
FIRE HAZARD

- A laundry center must be exhausted outdoors.
- DO NOT exhaust laundry center into a chimney, a wall, a ceiling, an attic, a crawl space or any concealed space of a building.
- A laundry center produces combustible lint. If the laundry center is not exhausted outdoors, some fine lint will be expelled into the laundry area. An accumulation of lint in any area of the home can create a health and fire hazard.
- Regularly inspect the outdoor exhaust opening and remove any accumulation of lint around the outdoor exhaust opening and in the surrounding area.

16

PRE-INSTALLATION REQUIREMENTS

The laundry center must be connected to an exhaust outdoors. **Prior to installing your new laundry center**, inspect the outdoor exhaust opening and remove any accumulation of lint around the outdoor exhaust opening and in the surrounding area.



WARNING

FIRE HAZARD

- DO NOT allow combustible materials (for example: clothing, draperies/curtains, paper) to come in contact with exhaust system. The laundry center **MUST NOT** be exhausted into a chimney, a wall, a ceiling, or any concealed space of a building which can accumulate lint, resulting in a fire hazard.
- DO NOT screen the exhaust ends of the vent system, or use any screws, rivets or other fasteners that extend into the duct to assemble the exhaust system. **No screen, grate, or guard of any mesh size is allowed to cover the exhaust opening. Lint can become caught in the screen, grate, guard, or on the screws or rivets, clogging the duct work and creating a fire hazard as well as increasing drying times.** Use an approved vent hood to terminate the duct outdoors, and seal all joints with metal foil tape. All male duct pipe fittings **MUST** be installed downstream with the flow of air.



Max. Number of 90° turns	MAXIMUM LENGTH of 4" (102 mm) Rigid Metal Duct	
	VENT HOOD TYPE	
	(Preferred)	
	4" (10.2 cm) louvered	2.5" (6.35 cm)
0	125 ft. (38 m)	110 ft. (33.5 m)
1	115 ft. (35 m)	100 ft. (30.5 m)
2	105 ft. (32 m)	90 ft. (27.5 m)
3	95 ft. (29 m)	80 ft. (24.5 m)
4	85 ft. (26 m)	70 ft. (21.5 m)



WARNING

FIRE HAZARD

- DO NOT install flexible plastic or flexible foil venting material.
- DO NOT exceed 8 ft. (2.4 m) duct length if installing semi-rigid venting.
- DO NOT use screws, rivets or other fasteners that extend into the duct to assemble the exhaust system.

Exhaust Direction

Directional exhausting can be accomplished by installing a quick-turn 90° dryer vent elbow directly to exhaust outlet of dryer. Dryer vent elbows are available through your local parts distributor or hardware store.

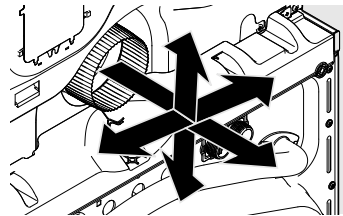

See Clearance Requirements



WARNING

FIRE HAZARD

Never exceed more than 4-90° elbows in the exhaust duct system. Exceeding the length of duct pipe or number of elbows allowed in the "MAXIMUM LENGTH" charts can cause an accumulation of lint in the exhaust system. Plugging the system could create a fire hazard, as well as increase drying times.

NOTE

90° quick-turn elbows are required to meet minimum installation depth.



WARNING

FIRE HAZARD

DO NOT install the laundry center where gasoline or other flammables are kept or stored. Installation must be a minimum of 18 inches (45.7 cm) above the floor if the laundry center is in a garage. Failure to do so can result in death, explosion, fire or burns.

In installations where the exhaust system is not described in the charts, the following method must be used to determine if the exhaust system is acceptable:

1. Connect an inclined or digital manometer between the laundry center and the point the exhaust connects to the laundry center.
2. Set the dryer timer and temperature to **air fluff** (cool down) and start the dryer.
3. Read the measurement on the manometer.
4. The system back pressure **MUST NOT** be higher than 1.0 inch of water column. If the system back pressure is less than 1.0 inch of water column, the system is acceptable. If the manometer reading is higher than 1.0 inch of water column, the system is too restrictive and the installation is unacceptable.

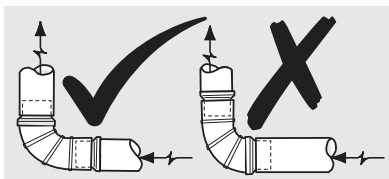

Install male fittings in the correct direction

Although vertical orientation of the exhaust system is acceptable, certain extenuating circumstances could affect the performance of the laundry center:

- Only rigid metal duct work should be used.
- Venting vertically through a roof may expose the exhaust system to down drafts causing an increase in vent restriction.
- Running the exhaust system through an uninsulated area may cause condensation and faster accumulation of lint.
- Compression or crimping of the exhaust system will cause an increase in vent restriction.
- **The exhaust system should be inspected and cleaned a minimum of every 18 months with normal usage.** The more the dryer is used, the more often you should check the exhaust system and vent hood for proper operation and that it is free of obstructions.

Manufactured or Mobile Home Installation

1. Installation **MUST** conform to current Manufactured Home Construction & Safety Standard, Title 24 CFR, Part 32-80 or the Standard For Mobile Homes, CAN/CSA-Z240 MH.
2. The laundry center **MUST** be exhausted outside (outdoors, not beneath the mobile home) using metal ducting that will not support combustion. Metal ducting must be 4 inches (10.16 cm) in diameter with no obstructions. Rigid metal duct is preferred.
3. If the laundry center is exhausted through the floor and area beneath the mobile home is enclosed, the exhaust system **MUST** terminate outside the enclosure with the termination securely fastened to a non-combustible portion of the mobile home structure.
4. Refer to previous sections in this manual for other important exhaust venting system requirements.
5. When installing a gas laundry center

into a mobile home, a provision must be made for outside make up air. This provision is to be not less than twice the area of the dryer exhaust outlet

6. Installer **MUST** anchor this gas laundry center or to the floor with approved Mobile Home Installation Kit - P/N 137067200.

Clearance Requirements



IMPORTANT

DO NOT INSTALL YOUR LAUNDRY CENTER:

- In an area exposed to dripping water or outside weather conditions. The ambient temperature should never be below 60° F (15.6° C) to maximize detergent effectiveness.
- In an area where it will come in contact with curtains, drapes, or anything that will obstruct the flow of combustion and ventilation air.
- In an area where gasoline or other flammables are kept or stored.
- On carpet. Floor **MUST** be solid with a maximum slope of 1 inch (2.5 cm). To minimize vibration or movement, reinforcement of the floor may be necessary.
- Do not install laundry center on pedestal.

Installation In a Recess or Closet

1. A laundry center installed in a recess or closet **MUST** be exhausted outdoors.
2. No other fuel burning appliance shall be installed in the same recess or closet as a gas laundry center.
3. Your laundry center needs space around it for proper ventilation. See the "Clearance Requirements" chart.
4. A minimum of 120 square inches of inlet ventilation opening to the recess or closet is required for proper air flow to the laundry center.

5. Inlet air ventilation to the recess or closet can be satisfied by adding 120 square inches of opening, equally divided at the top and bottom of the door and located 3 inches from the bottom and top of the door.

or, adding 120 square inches of ventilation openings to the top, sides or rear wall of the closet wall, if the wall is adjacent to an open room, hallway, or exterior.

or, a louvered door with equivalent air openings equaling 120 sq. inches of ventilation for the full length of the door is acceptable.

It is **NOT** approved to derive the 120 sq. inches of ventilation from the space between the door edges and the casing or the floor.

** The presence of forced heating and air-conditioning vent openings in the closet does **NOT** satisfy the 120 square inch ventilation requirement to the closet.



NOTE

To achieve an installation with 0" (0 cm) clearance for the back of the dryer (for other than straight back venting), a quick-turn 90° dryer vent elbow must be installed as described previously in this manual.

For other than straight back venting, a quick-turn 90° dryer vent elbow must be installed to achieve 0" (0 cm) installation.

Ventilation Examples

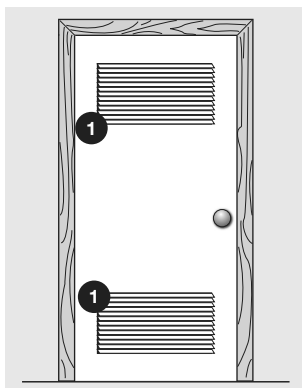

1. 120 sq inches equally divided (60 sq in.) split vent door

PRE-INSTALLATION REQUIREMENTS

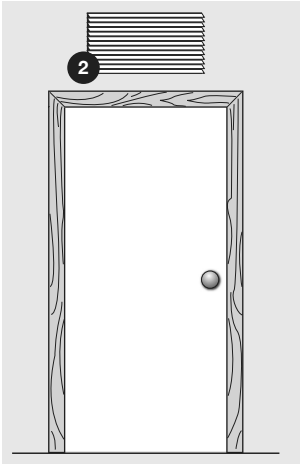

2. Solid Door with 120 sq Wall Ventilation

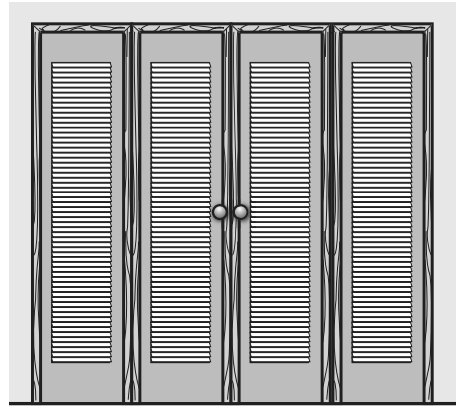

Bi-Fold louvered doors with 120 sq. in of ventilation

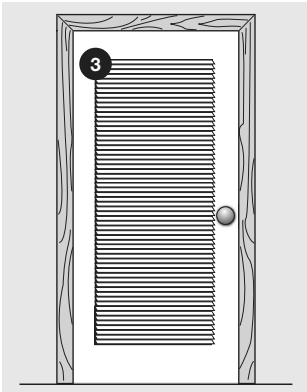

3. Louvered Door with 120 sq. Inches min. Louvered Opening

120 sq. Inches of wall venting

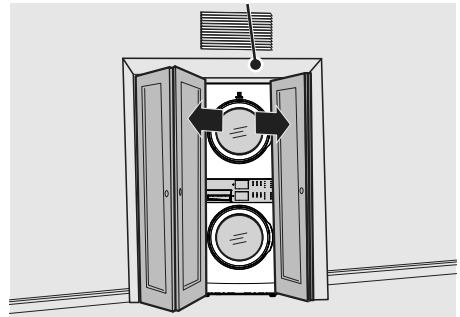

Solid Bi-Fold doors with no ventilation requires door open for 120 sq. Inches of wall venting

MIN. INSTALLATION CLEARANCES - Inches (cm)				
	Sides	Rear	Top	Front
Alcove/recess	0" (0 cm)	0" (0 cm)	0" (0 cm)	Open
Closet with door vent	0" (0 cm)	0" (0 cm)	0" (0 cm)	1" (2.5 cm)
Closet with wall vent	1" (2.5 cm)	1" (2.5 cm)	1" (2.5 cm)	1" (2.5 cm)

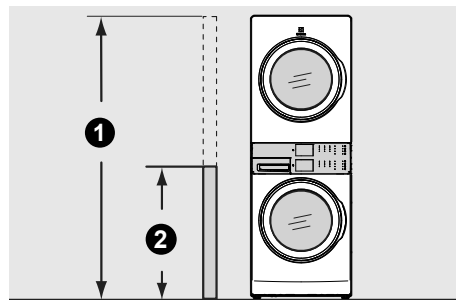

1. 96" (244cm) max.
2. 24" (61 cm) min.

Laundry Center Dimensions

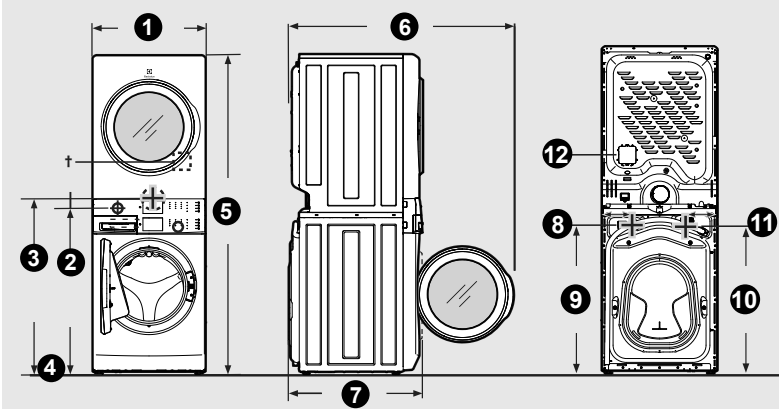

† Dryer electrical supply on rear of unit.

NOTE

- Allow minimum 36" of depth space for proper installation with 90° quick turn elbow for venting.
- Connection of water inlet hose on steam laundry center adds 3/4 in. (2 cm) to installation depth.
- Power supply cord length on washer approximately 60 inches (152.5 cm).
- Drain hose length on washer approximately 59 inches (150 cm).
- Power supply cord length on gas laundry center or electric Canadian laundry center approximately 60 inches (152.5 cm).

Laundry Center Dimensions

1. Unit width	27" (69 cm)
2. Height to gas supply pipe on rear of gas unit	39.7" (101 cm)
3. Centerline height for rear vent	41.8" (106 cm)
4. Floor line	--
5. Unit height	76.3" (194 cm)
6. Door clearance	53.9" (137 cm)
7. Unit depth	31.9" (81 cm)
8. Width distance to water connections	7.8" (20 cm)
9. Height to water connections	35.7" (91 cm)
10. Height to washer power connections	35.5" (91 cm)
11. Width distance to washer power connections	7.1" (18 cm)
12. Height to dryer electrical supply	48" (122 cm)

Unpacking the Laundry Center



CAUTION

EXCESSIVE WEIGHT HAZARD

It is best for two people to work as a team to move or lift the laundry center to avoid injury.



WARNING

Do not allow the unit to fall when tipping to remove packing materials.



IMPORTANT

Save the foam base and shipping plug to help prevent damage during any future moves.

1. Tape dryer and washer doors closed. A person must stand in front and rear of unit. Tilt unit forward. Front person must hold unit while rear person removes Styrofoam support from underneath the interior of the washing machine.

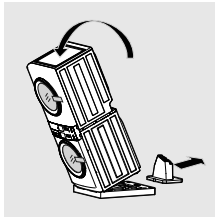

2. Return unit to original position.

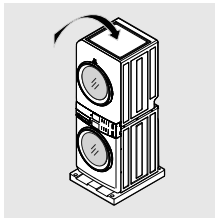

3. The people in front and rear of the unit must hold the base pad in place while walking the unit towards the rear of the Styrofoam pad until both rear feet of the unit are firm on the ground.

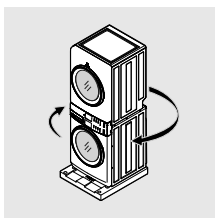

4. Maintaining a hold the unit at all times, tilt backward so the bottom rear of the unit contacts the floor. Have the rear person hold unit while the person in front person removes the Styrofoam pad from underneath the unit

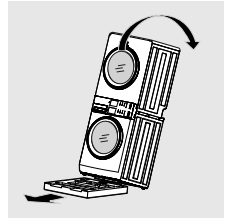

5. Tilt unit forward to standing position on floor.

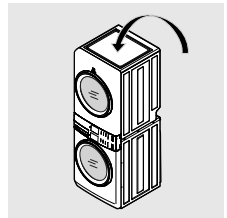

IMPORTANT

- DO NOT place the laundry center onto its back without the shipping bolts.
- DO NOT tip washer upside down onto its top or right side for any reason.



IMPORTANT

Failure to remove shipping hardware completely could result in damage to the appliance, damage to your home, or unexpected washing results.

Save all shipping bolts and spacers for future use. If the washer is to be transported at a later date, the shipping hardware must be reinstalled to help prevent shipping damage

22 INSTALLATION

Decoupling the Laundry Center (if Needed)

This Laundry Center can be disassembled in special cases, such as to aid with moving through the house and final installation or during removal. If decoupling is not necessary, skip these steps and proceed to the **Installing the Hole Plugs** section.

NOTE

The units will not work separately when disassembled and must be re-assembled when final installation is complete.

WARNING

- Disassembling this Laundry Center must be performed by a service agency or qualified installers.
- This operation requires at least 2 people to move or lift the units. Do not disassemble or repair this Laundry Center by yourself.
- Use safety protective items such as glasses, gloves, sleeves and shoes to reduce the risk of injuries.
- ALWAYS DISCONNECT BOTH POWER SUPPLIES BEFORE SERVICE OR REPAIR.

1. Use the tools listed in the Pre-Installation Requirements section of this Use & Care Manual.
2. Prepare the work area. Use protective products designed to protect the floor against water and scratches while handling the units.

3. Remove the two screws on the back of the Laundry Center to disconnect the dryer from the rear bracket. Do not remove the bracket.

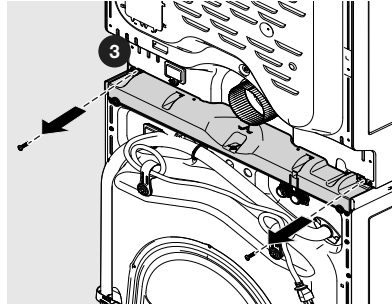

3. Rear Bracket

4. Pull the drawer out until it stops.
5. Press down firmly on the lock tab in the right rear corner of the dispenser cavity to release, then pull out the drawer.

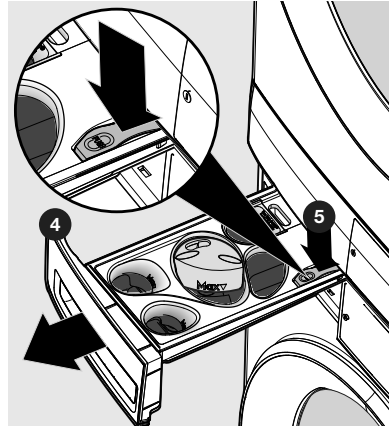

4. Dispenser Drawer

5. Lock Tab

6. Unscrew the two screws in the dispenser housing to remove.

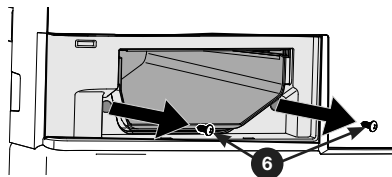

6. Dispenser screws

7. Unsnap the two plastic tabs on both sides of the control panel.
8. Remove the two screws on both sides of the control panel.

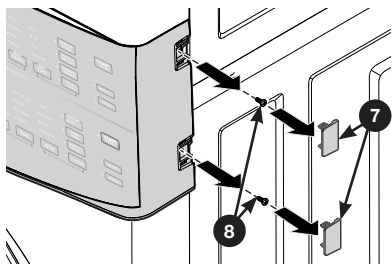

7. Plastic screw tabs
8. Control panel screws

9. Pull the control panel forward to remove.

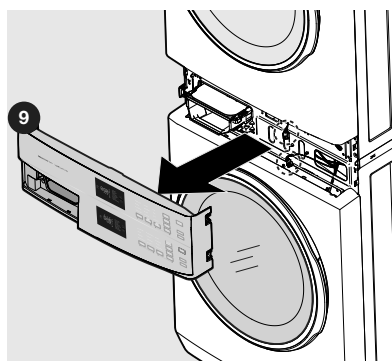

9. Control panel

10. Disconnect the washer wiring harness from the control panel.
11. Disconnect the dryer wiring harness from the control panel.

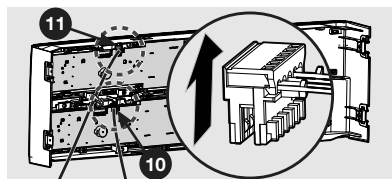

10. Washer harness
11. Dryer harness

12. Use curved-nose pliers to disconnect the dryer harness clip from the control panel.

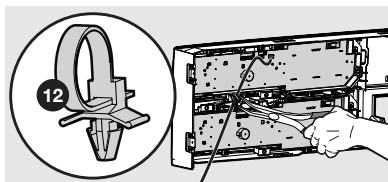

12. Dryer harness clip

13. Remove the ten screws securing the front bracket in place to disconnect the dryer from the front bracket.

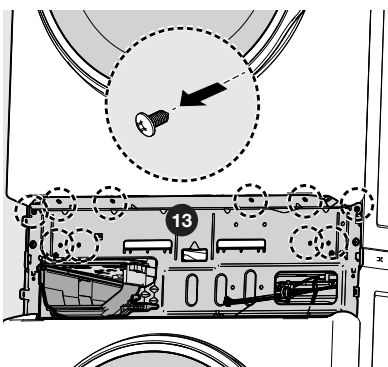

13. Front Bracket

14. With at least two persons, carefully lift the dryer and set it down on the floor.

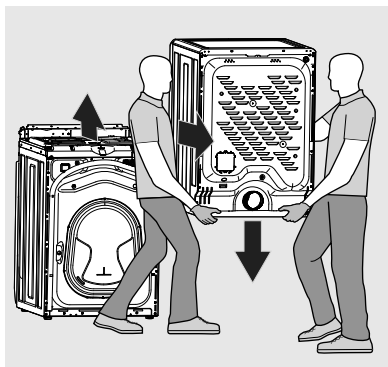

15. The laundry center can now be moved to the final installation location.
16. Reverse the steps to re-assemble the Laundry Center.

24 INSTALLATION

Removing Shipping Hardware

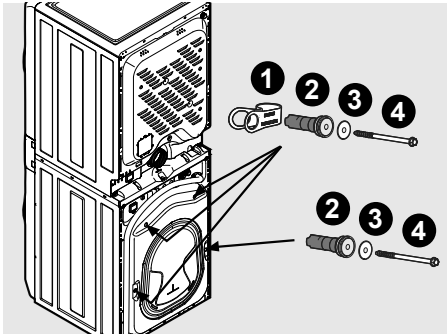

1	3 P Clamps
2	4 Black Spacers
3	4 Shims
4	4 Bolts

Installing Hole Plugs

Locate the 4 hole plugs in the small bag supplied with the laundry Center instruction manuals. Insert them in the holes in the washer back panel where the shipping hardware has been removed.

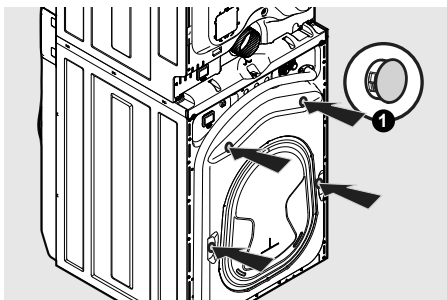

1. Hole Plug x 4

Leveling the Laundry Center

Excessive noise and vibration can be prevented by properly leveling the laundry center.

1. Place a level on top of the laundry center with the unit within 3 ft (1 m) of the final location for free standing installation.

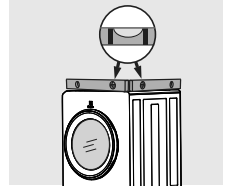

2. Use an adjustable wrench to adjust the leveling legs so the unit is stable corner-to-corner and level front-to-back and side-to-side, and.

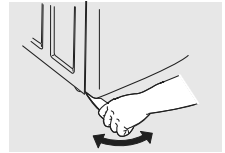

3. Press down on alternate corners and sides and feel for the slightest movement.

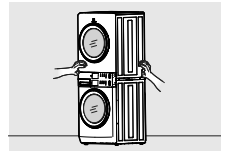

Adjust the appropriate leg(s) so the unit sits solidly on the floor on ALL four legs. Keep the leveling leg extension at a minimum for best performance of the laundry center.

Connecting the Water

1. Run some water from the hot and cold faucets to flush the water lines and remove particles that might clog the water valve screens and to determine which faucet is hot and which is cold supply.

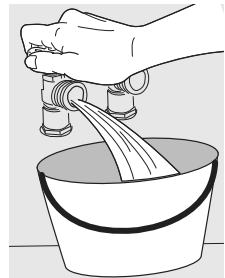

2. Check to ensure that the inlet hoses have the rubber washer firmly in place.

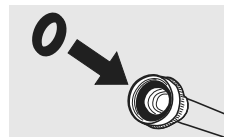

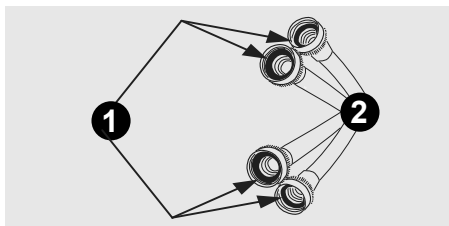

1. Rubber washers must be present
2. Use only new hoses

NOTE

Hoses are not included with Laundry Center purchase.

3. Connect the HOT inlet hose to the HOT inlet connection (red) and the COLD inlet hose to the COLD inlet connection (blue) on the laundry center.

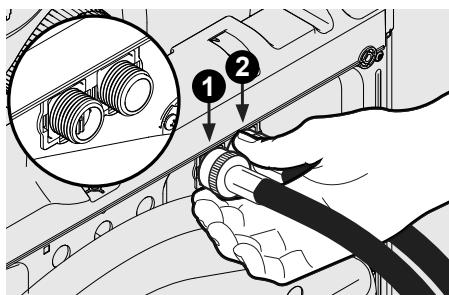

1. Cold Inlet
2. Hot Inlet

IMPORTANT

The cold water inlet will have a blue cap cover on the inlet connection and the hot water inlet will have a red cap cover on the inlet connection.

4. Tighten by hand until snug. Then tighten each supply connection another 2/3 turn with pliers. **Do not cross thread or over-tighten these connections.**

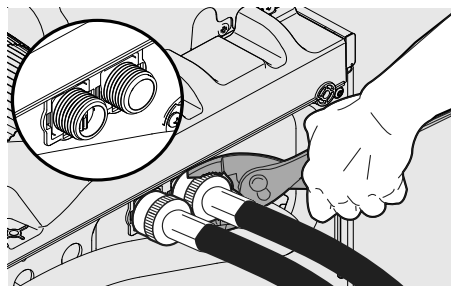

5. Connect the HOT inlet hose to the HOT water supply and the COLD inlet hose to the COLD water supply.

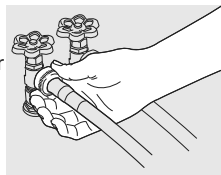

6. Tighten by hand until snug. Then tighten each supply connection another 2/3 turn with pliers. **Do not bend, kink or pinch water inlet hoses.**

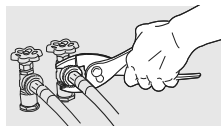

7. Turn on the water and check for leaks.

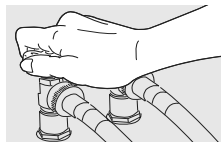

26 INSTALLATION

Connecting the Drain

1. Verify the anti-siphon disc is in place.
2. Form a "U" shape on the end of the drain hose with the hose pointed toward the drain. Place the formed end in a laundry tub or a standpipe and secure the drain hose with the cable tie (provided in the manual bag) to the standpipe, inlet hose, laundry tub, etc. so the hose does not pull out from the force of the water.

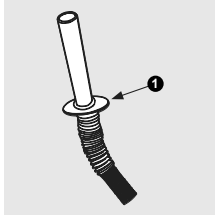

1. Anti-Siphon Disc

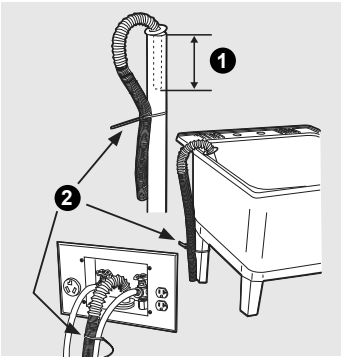

1. Insert less than 8.5" (21.5cm).
2. Cable tie

NOTE

The standpipe inside diameter must be 1-1/4" (3.2 cm) minimum. There must be an air gap around the drain hose in the standpipe. A snug hose fit can cause a siphoning action.

IMPORTANT

Check to ensure the power is off at a circuit breaker/fuse box before plugging the power cord into an outlet.

Completing the Installation

1. Plug the power cord into a grounded outlet.



WARNING

ELECTRICAL SHOCK HAZARD

Improper connection of the equipment grounding conductor can result in a risk of electrical shock. Check with a licensed electrician if you are in doubt as to whether the appliance is properly grounded.

2. Turn on the power at a circuit breaker/fuse box.
3. Carefully slide the washer to its final position. Recheck for level and rock corners for stability. See *Leveling the laundry center*. Remove and discard door tape.
4. Run the washer through a complete cycle, checking for water leaks and proper operation.
5. If you have any questions during initial operation, please review the *Troubleshooting* section before calling for service.
6. Place these instructions in a location near the washer for future reference.



NOTE

A wiring diagram and technical data sheet are located behind the control panel.

Connecting the Electrical System

The following are specific requirements for proper and safe electrical installation of your laundry center. Failure to follow these instructions can create electrical shock and/or a fire hazard.



WARNING

ELECTRICAL SHOCK HAZARD

- This appliance **MUST** be properly grounded. Electrical shock can result if the laundry center is not properly grounded. Follow the instructions in this manual for proper grounding.
- **DO NOT** use an extension cord with this laundry center. Some extension cords are not designed to withstand the amounts of electrical current this laundry center utilizes and can melt, creating electrical shock and/or fire hazard. Locate the laundry center within reach of the receptacle for the length power cord to be purchased, allowing some slack in the cord. Refer to the *Pre-Installation Requirements* section of this manual for the proper power cord to be purchased.



WARNING

ELECTRICAL SHOCK HAZARD

- A U.L.-approved strain relief must be installed onto power cord. If the strain relief is not attached, the cord can be pulled out of the dryer and can be cut by any movement of the cord, resulting in electrical shock.
- **DO NOT** use an aluminum wired receptacle with a copper wired power cord and plug (or vice versa). A chemical reaction occurs between copper and aluminum and can cause electrical shorts. The proper wiring and receptacle is a copper wired power cord with a copper wired receptacle.



NOTE

Dryers operating on 208 volt power supply will have longer drying times than dryers operating on 240 volt power supply.

The laundry center, when installed, must be electrically grounded in accordance with local codes and the National Electrical code ANSI/NFPA 70 or the Canadian Electrical Code, Part 1, CSA C22.1.

For a Grounded, Cord-connected Laundry Center:

1. The laundry center **MUST** be grounded. In the event of a malfunction or breakdown, grounding will reduce the risk of electrical shock by providing a path of least resistance for electrical current.
2. After you purchase and install a 3-wire or 4-wire power supply cord having an equipment-grounding conductor and a grounding plug that matches your wiring system, the plug **MUST** be plugged into an appropriate, copper wired receptacle that is properly installed and grounded in accordance with all local codes and ordinances. If in doubt, call a licensed electrician.
3. **DO NOT** modify the plug you've installed on this appliance. If it will not fit the outlet, have a proper outlet installed by a qualified electrician.

For a Permanently Connected Laundry Center:

The laundry center **MUST** be connected to a grounded metal, permanent wiring system; or an equipment grounding conductor must be run with the circuit conductors and connected to the equipment-grounding terminal or lead on the appliance.

Grounding Requirements - Electric Laundry Center (Canada)



WARNING

Improper grounding of the laundry center may cause serious injury or death. Check with a licensed electrician if you are in doubt as to whether the appliance is properly grounded.



CAUTION

Do not, under any circumstances, cut, remove, or bypass the grounding prong.

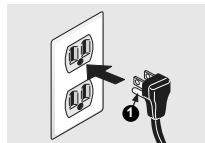

1. Power cord with grounded prong.

28 INSTALLATION

Electrical Connection (non-Canada) - 3 wire cord



3-wire receptacle
(NEMA type 10-30R)



WARNING

ELECTRICAL SHOCK HAZARD

Failure to disconnect power source before servicing could result in personal injury or even death.



WARNING

ELECTRICAL HAZARD

Label all wires prior to disconnection when servicing controls. Wiring errors can cause improper and dangerous operation. Verify proper operation after servicing.

1. Turn off power supply to outlet
2. Remove the screw securing the terminal block access cover in the lower corner on the back of the laundry center.
3. Install a UL-approved strain relief according to the power cord/strain relief manufacturer's instructions in the power cord entry hole below the access panel. At this time, the strain relief should be loosely in place.
4. Thread an UNPLUGGED, UL-approved, 30 amp. power cord, NEMA 10-30 type SRDT, through the strain relief.
5. Attach the power cord neutral (center wire) conductor to the SILVER colored center terminal on the terminal block. Tighten the screw securely.
6. Attach the remaining two power cord outer conductors to the outer, BRASS colored terminals on the terminal block. Tighten both screws securely.



WARNING

ELECTRICAL SHOCK HAZARD

DO NOT make a sharp bend or crimp wiring/conductor at connections.

7. Follow manufacturer's guidelines for firmly securing the strain relief and power cord.
8. Reinstall the terminal block cover.

Grounding Requirements - Gas Dryer

1. The dryer is equipped with a three-prong (grounding) plug for your protection against shock hazard and should be plugged directly into a properly grounded three-prong receptacle.
2. The plug must be plugged into an appropriate outlet that is properly installed and grounded in accordance with all local codes and ordinances. If in doubt, call a licensed electrician.
3. **DO NOT** modify the plug provided with this appliance. If it will not fit the outlet, have a proper outlet installed by a qualified electrician.



IMPORTANT

If moving laundry center from a 4-wire system and installing it in a 3-wire system, move the internal ground from the center terminal back to the GREEN screw next to the terminal block.

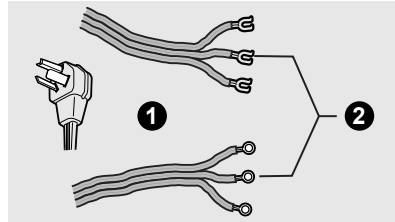

1. Rubber washers must be present.
2. Use only new hoses.

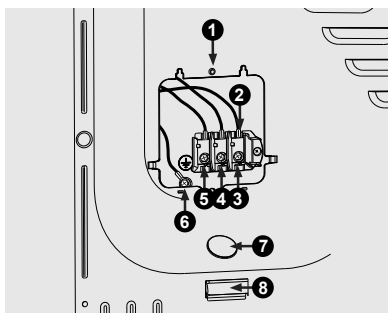

1. Access Cover Screw
2. Terminal Block
3. Line 2 (BRASS Terminal)
4. Neutral (SILVER Terminal)
5. Line 1 (BRASS Terminal)
6. Internal Ground (GREEN Screw)
7. Install UL-Approved Strain Relief Here
8. Terminal Screw Recovery Slot

NOTE

If a terminal screw falls during cord installation, it can be retrieved in the terminal screw recovery slot below the access panel.

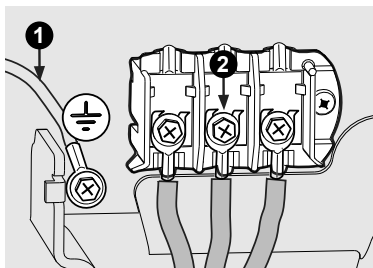

1. Internal Ground
2. Neutral Terminal

CAUTION

DO NOT remove an internal ground from a 3-wire system

Electrical Connection (non-Canada) - 4 Wire Cord



4-wire receptacle
(NEMA type 14-30R)



WARNING

ELECTRICAL SHOCK HAZARD

Failure to disconnect power source before servicing could result in personal injury or even death.



WARNING

ELECTRICAL HAZARD

Label all wires prior to disconnection when servicing controls. Wiring errors can cause improper and dangerous operation. Verify proper operation after servicing.

1. Turn off power supply to outlet.
2. Remove the screw securing the terminal block access cover in the lower corner on the back of the laundry center.
3. Install a UL-approved strain relief according to the power cord/strain relief manufacturer's instructions in the power cord entry hole below the access panel. At this time, the strain relief should be loosely in place.
4. Thread an UNPLUGGED, UL-approved, 30 amp. power cord, NEMA 14-30 type DRT or SRDT, through the strain relief.
5. Disconnect the internal (WHITE) dryer harness ground wire from the (GREEN) ground screw next to terminal block.
6. Attach the ground (GREEN) power cord wire to the cabinet with the ground (GREEN) screw. Tighten the screw securely.
7. Move the internal dryer harness ground (WHITE) wire to the terminal block and attach it along with the neutral (WHITE) power cord wire conductor to center, SILVER colored terminal on the terminal block. Tighten the screw securely.
8. Attach the RED and BLACK power cord conductors to the outer, BRASS colored terminals on the terminal block. Tighten both screws securely.

30 INSTALLATION



WARNING

ELECTRICAL SHOCK HAZARD

DO NOT make a sharp bend or crimp wiring/conductor at connections.

9. Follow manufacturer's guidelines for firmly securing the strain relief and power cord.
10. Reinstall the terminal block cover.

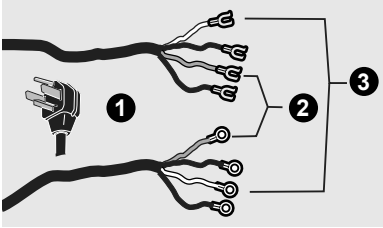

1. 30 AMP NEMA 14-30
2. Ground (GREEN wire)
3. Neutral (WHITE wire)

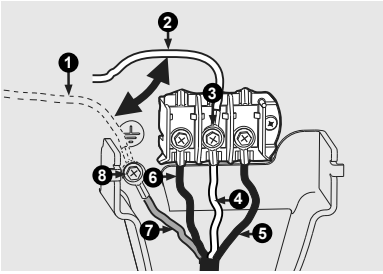

1. Internal ground (WHITE) initial location.
2. Move (WHITE) wire to neutral (SILVER) terminal for 4-wire system.
3. Neutral (SILVER Terminal)
4. WHITE neutral wire
5. BLACK or RED power wire
6. BLACK or RED power wire
7. GREEN ground wire
8. GREEN Ground screw



NOTE

If a terminal screw falls during cord installation, it can be retrieved in the terminal screw recovery slot below the access panel.

Connecting the Gas



WARNING

Adjustments to the gas burner should only be performed by qualified service personnel.

This gas laundry center comes from the factory with natural gas burner components installed. **DO NOT** operate this gas laundry center, using LP (liquid propane) gas, unless the LP gas conversion kit has been properly installed by a qualified service personnel. Improper gas installation or LP conversion kit installation could result in injury or even death.

1. Remove the shipping cap from gas pipe at the rear of the laundry center.



WARNING

DO NOT connect the laundry center to L.P. gas service without converting the gas valve. An L.P. conversion kit PN# PCK4200 (not included) **must be installed by a qualified gas technician.**

2. Connect a 1/2 inch (1.27 cm) I.D. semi-rigid or approved pipe from gas supply line to the 3/8 inch (0.96 cm) pipe located on the back of the laundry center. Use a 1/2 inch to 3/8 inch (1.27 cm to 0.96 cm) reducer for the connection. Apply an approved thread sealer that is resistant to the corrosive action of liquefied gases on all pipe connections.

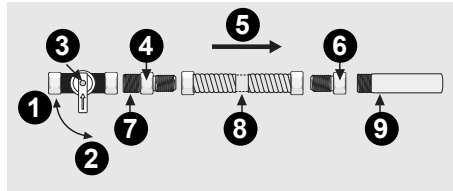

All connections must be wrench-tightened

1. Valve open position
2. Valve closed position
3. Manual Shutoff valve
4. Flare union
5. Gas flow
6. Flare union
7. Nipple
8. Flexible connector
9. Inlet pipe on back of laundry center

- Open the shutoff valve in the gas supply line to allow gas to flow through the pipe. Wait a few minutes for gas to move through the gas line.



IMPORTANT

The supply line must be equipped with an approved manual shutoff valve. This valve should be located in the same room as the laundry center and should be in a location that allows ease of opening and closing. **DO NOT** block access to the gas shutoff valve.

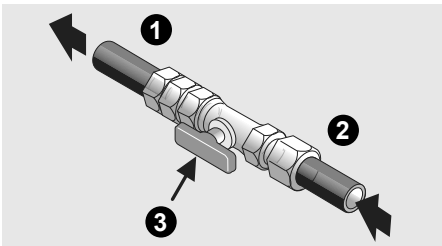

- To dryer connection
- From Gas supply
- Shutoff Valve in open position.

- Check for gas system leaks with a manometer. If a manometer is not available, test all connections by brushing on a soapy water solution.



WARNING

EXPLOSION HAZARD

NEVER test for gas leaks with an open flame.



IMPORTANT

Installation to the gas service must follow local codes and ordinances and the latest edition of the National Fuel Gas Code ANSI Z223.1/NFPA 54 or in Canada, CSA B149.1.

Connecting the Water (steam models only)



WARNING

Periodically inspect all water inlet hoses for water leaks, wear, cuts, corrosion and bulges. Replace all hoses, if any sign of the above is visible. All hoses should be replaced every 5 years to reduce the risk of hose failures.

- Rubber washer must be present and undamaged
- Cold inlet hose to washer

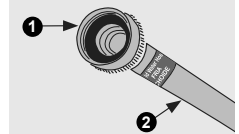

- Remove COLD inlet hose from COLD water supply and inspect for rubber washer. Replace washer if it is torn or worn out.

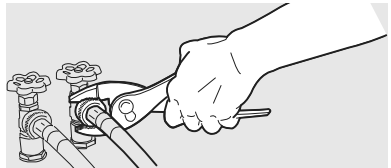

- Turn on COLD supply and run water to clear any contaminants in the line.



- Inspect hose couplings for proper placement of rubber washers. Use hoses from ASSEMBLY HOSE KIT# 5304495002 (not included).

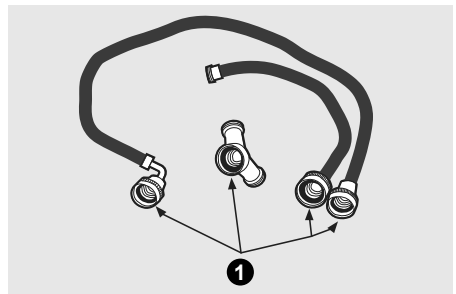

- Rubber washer must be present and undamaged.

32 INSTALLATION

- If your installation has room for the COLD water supply to accept the "Y" connector directly, thread the "Y" connector to the COLD water supply and snug it by hand; then tighten it another 2/3 turn with pliers.

NOTE

If you were able to install the "Y" connector directly to the COLD water supply, please skip to step 8.

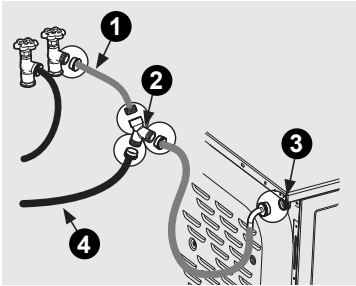

- Short hose
- "Y" connector
- Water Inlet on dryer
- Cold water supply hose to washer

- If there is not room to install the "Y" connector directly, thread the short extension hose on to the COLD water supply and snug it by hand; then tighten it another 2/3 turn with pliers.
- Thread the "Y" connector to the short extension hose and snug it by hand; then tighten it another 2/3 turn with pliers.
- Connect the COLD inlet hose for the washer to the "Y" connector and snug it by hand; then tighten it another 2/3 turn with pliers.
- Connect the straight end of the long hose from the kit to the other outlet on the "Y" connector and snug it by hand. Connect the hose's 90° coupling to the brass water inlet on the back of the laundry center and snug it by hand. Tighten each connection of the dryer inlet hose another 2/3 turn with pliers.

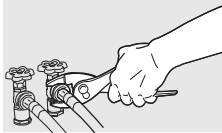

- Turn on the water and check for leaks at all connections.

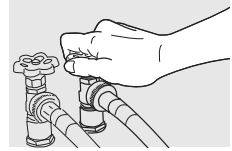

Completing the Installation

- Connect the exhaust duct to the outside exhaust system. Use of a 4" (102 mm) clamp (item A) is recommended to connect the dryer to the exhaust vent system. Use metal foil tape to seal all other joints.

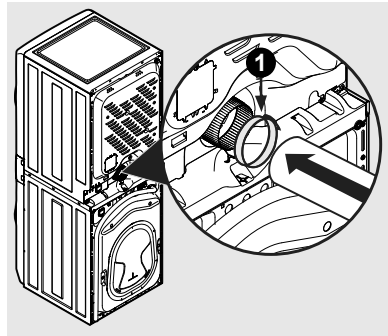

IMPORTANT

Be sure the power is off at a circuit breaker/fuse box before plugging the power cord into an outlet.

- Plug the power cord into a grounded outlet.

WARNING

Improper grounding of the laundry center may cause serious injury or death. Check with a licensed electrician if you are in doubt as to whether the appliance is properly grounded.

- 3-Wire Grounded Plug
- 4-Wire Grounded Plug

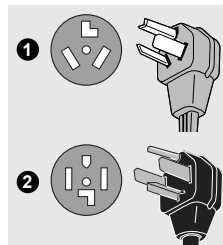



WARNING

Do not store combustible materials, gasoline, and other flammable vapors and liquids near this laundry center.

3. Turn on the power at the circuit breaker/fuse box.
4. Read the Use & Care Manual provided with the laundry center. It contains valuable and helpful information that will save you time and money.
5. If you have any questions during initial operation, please review the "Avoid Service Checklist" in your Use & Care Manual before calling for service.
6. Place these instructions in a location near the laundry center for future reference.



NOTE

A wiring diagram and technical data sheet are located behind the console.



CAUTION

Remove the door when discarding or storing your old laundry center.

Reversing the Washer Door



NOTE

Door reversibility is available on all models.

Tools Needed for Reversal:

1. Screwdriver with #2 square bit
2. Plastic knife

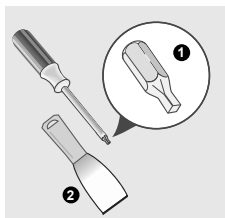

IMPORTANT

BEFORE YOU REVERSE WASHER DOOR:

1. Be sure you have adequate swing area before reversing door.
2. Gather your tools - including a screw driver with a #2 square bit and plastic knife (or small, flat prying tool that won't damage paint).
3. Protect flat work surface, such as top of washer or floor near washer, with a soft cloth or towel.
4. Be sure laundry center is unplugged from power source!

Removing Washer Door Assembly

1. Completely open the door to expose all four hinge screws.
2. Remove all four hinge screws with #2 square bit driver. Save for reinstalling later.

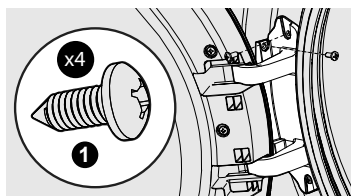

Remove 4 fine thread screws

3. Hold the door with one hand supporting the handle area and one hand supporting the hinge. While supporting the door at the hinge, press firmly with the other hand until the locating pins on the back of the hinge plate dislocate from the front panel.

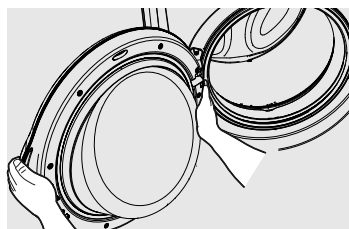

34 INSTALLATION

4. While supporting the door with one hand, pinch the tabs to release the plastic terminal cap from the hinge plate.



IMPORTANT

Take care not to pull the door away from the washer until you remove the wiring harness terminal cap.

5. Set the door face down on a flat surface protected by soft cloth or towel.
6. Release wiring harness from retainer on plastic terminal cap.

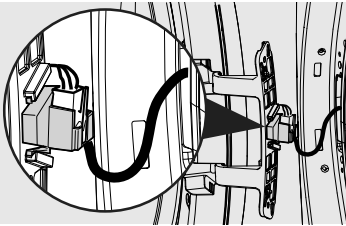

7. Then release terminal from terminal cap. Save the cap to reinstall later.

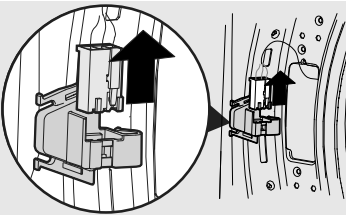

Removing Washer Door Lock and Plastic Hole Cover

1. Locate and remove both screws from door lock. Save screws for later.
2. Rotate the lock as you pull it out through the front panel. Take care not to pull too hard or too far as the lock is still attached to the wiring harness.

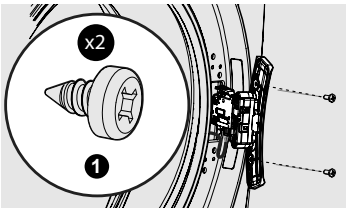

Remove coarse thread screw

3. Disconnect the wiring harness terminal from the door lock. Set the door lock aside for re-installation later.
4. Pry the bottom of the plastic hole cover upward to release it from the front panel. You may have to use a non-scratching plastic knife if you are unable to release it manually. Then, slide the cover down slightly and remove it from the front panel.

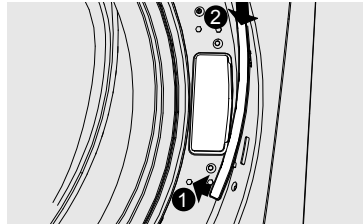

Reinstalling Washer Door Lock and Hole Cover

1. Move the plastic cover to the other side of the front panel. Position the cover so the "hook" is at the bottom. Insert hook into lower slot, slide the cover down, and press upper retention tabs into opening until they snap into place.

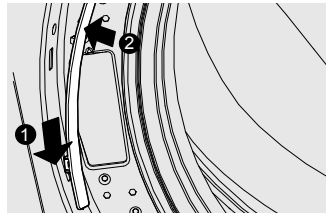

2. Insert wiring harness into door lock.
3. Insert door lock into front panel and reinstall door lock screws.

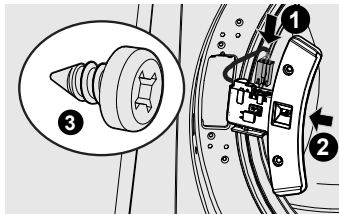

Reinstall coarse thread screw

Reversing Washer Door Assembly

1. Locate nine screws on inner door ring. Remove each and save for re-installation later. Remove inner door (with hinge) and carefully set aside.

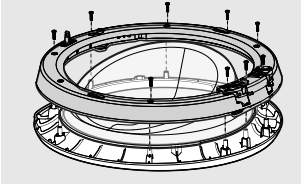

2. Lift door bowl slightly and rotate 180 degrees, setting it back onto outer door.

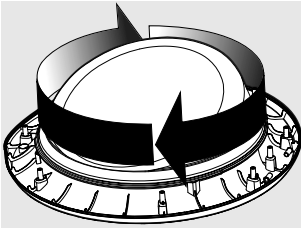

3. Make sure the alignment tabs reengage.

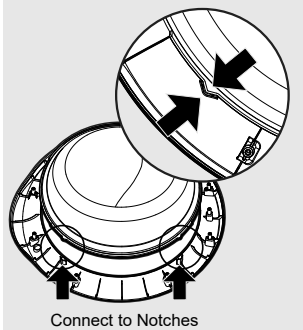

4. Reattach the inner door to the outer door using the nine screws removed earlier. See illustration, Step 1.
5. Check to verify that the scoop (wider section) of the door bowl is situated at the BOTTOM of the door.

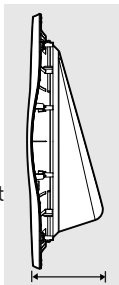

Reinstalling Washer Door Assembly

1. Insert the wiring harness terminal into the terminal cap and wrap the harness into the harness retainer.

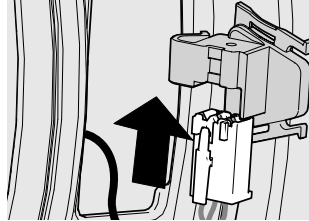

2. Slide terminal cap onto back of hinge plate until tabs snap into place.

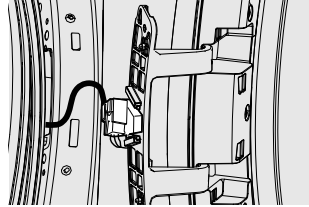

3. Insert hinge locating pins into the hole that were previously covered by the plastic hole cover. Press on the face of the hinge to snap the other locating pins into place.

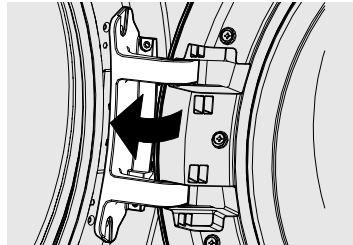

4. Reinstall all four screws removed earlier - two front screws first, then two side screws.

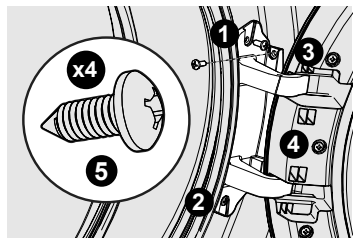

Reinstall fine thread screw

36 INSTALLATION

Verify Reversed Washer Door Operation

1. Test door for free, smooth swinging operation and secure latching when closed.
2. Verify inner door bowl is in the correct orientation with the "scoop" at the bottom.

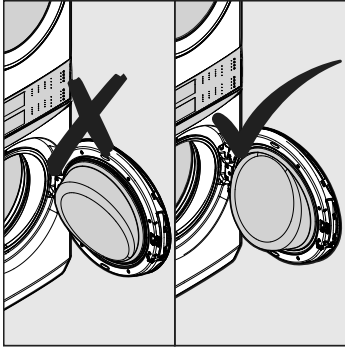

3. Plug in washer and close the door. Test correct door lock operation by starting a test cycle: lock should engage, and door should not be able to be opened until cycle is paused or canceled.

Reversing the Dryer Door



WARNING

FIRE HAZARD

Failure to Follow these instructions may result in a fire hazard. All steps must be followed.



IMPORTANT

BEFORE YOU REVERSE YOUR DRYER DOOR:

1. Be sure you have adequate swing area before reversing door.
2. Gather your tools - including a screw driver with a #2 square bit and plastic knife (or small, flat prying tool that won't damage paint).
3. Be sure laundry center is unplugged from power source!



NOTE

Door reversibility is available on all models.

Tools Needed for Dryer Door Reversal:

1. Screwdriver with #2 square bit
2. Plastic knife

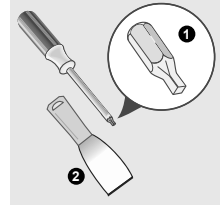

Removing Latch and Hole Plugs

1. Open the door.
2. Remove plastic hole plugs and save to reinstall later. You may have to use a non-scratching plastic knife if you are unable to dislodge the plugs manually.

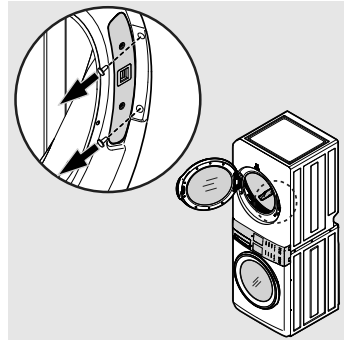

3. Remove both screws from door latch. Save latch and screws for re-installation later.

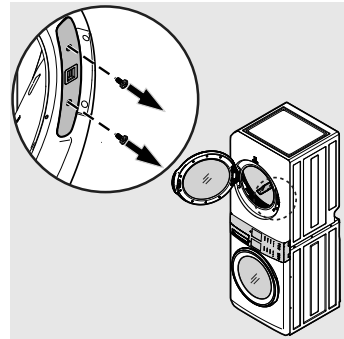

Removing Dryer Door Assembly

1. Open the door and remove screws with #2 square bit drive. Save for reinstallation.
2. Remove the door assembly and place on a cloth or towel on a flat surface.

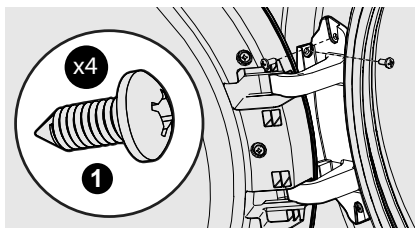

3. Remove the decorative caps from the front panel and save for reinstallation.

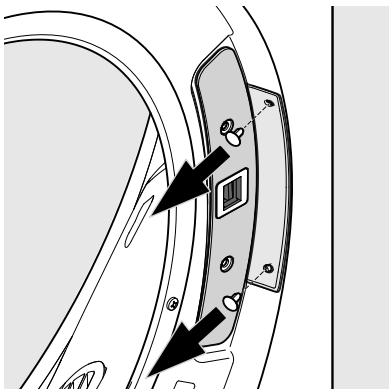
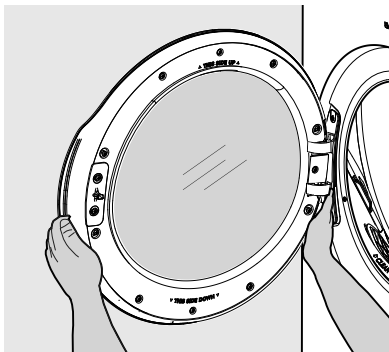

Reversing Dryer Door Assembly

1. Locate and remove the two screws securing the latch. Save the screws and latch for reinstallation.

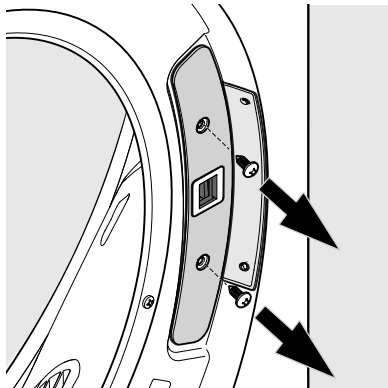

2. Locate and remove the screw holding the hinge cover. Save the screw and cover for reinstallation.

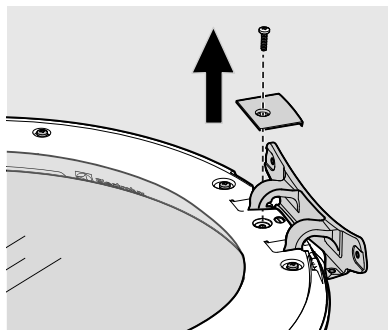

38 INSTALLATION

3. Locate and remove the two screws holding the striker. Save the screws and latch for reinstallation.

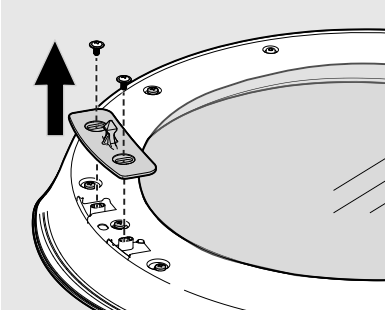

4. Remove remaining eight screws using a #2 square bit driver. Save the screws for reinstallation.

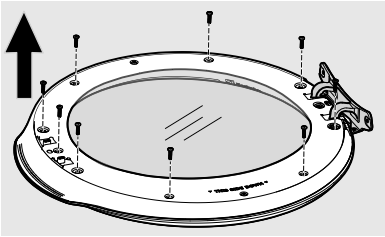

➔ IMPORTANT

Do not remove the torque screws at the twelve and 6 o'clock positions.

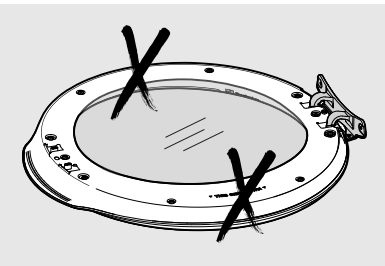

5. Lift the metal ring and rotate it 180 degrees, setting it back on the inner frame. Ensure gasket has not separated from the metal ring.

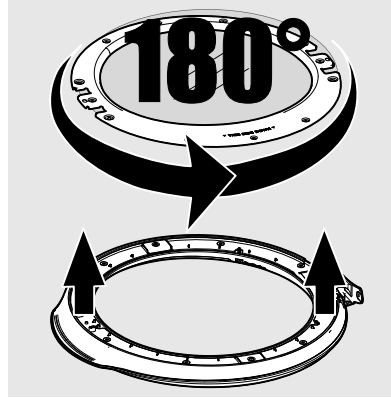

6. Make sure "THIS SIDE UP" AND "THIS SIDE DOWN" on the metal ring point in the corresponding directions.

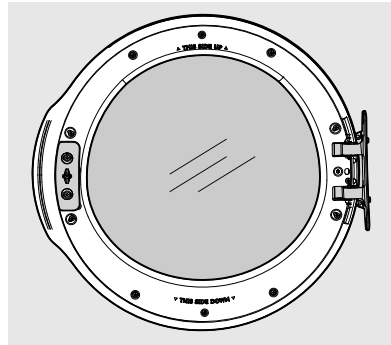

7. Reinstall all eight screws using a #2 square bit driver.

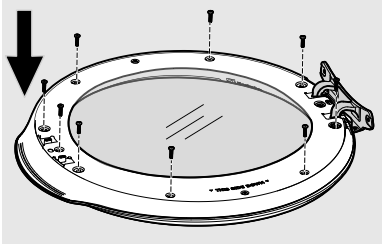

8. Verify the gasket has not separated from the metal ring. Go back to step 5 if the gasket has separated.
9. Reinstall the striker and previously removed screws.
10. Reinstall the hinge cover.

Reinstalling door Assembly

1. Rotate the door and hang the upper hook on the back of the hinge in the upper hole of the front panel.

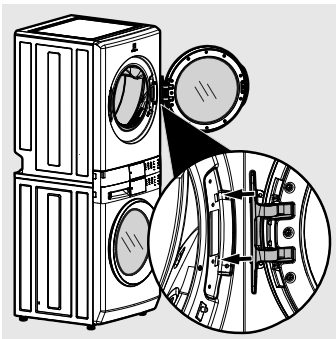

2. Reinstall and tighten all four screws removed earlier - two front screws first, then the two side screws.

Reinstalling Latch and Hole Plugs

1. Install the door latch using the previously removed screws.

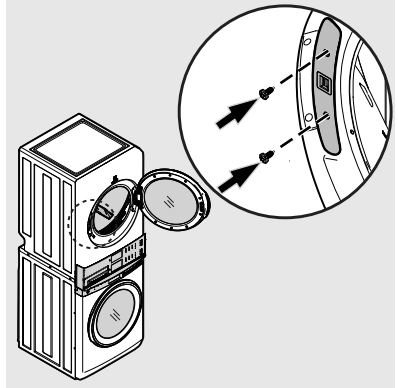

2. Reinsert the plastic hole plugs.

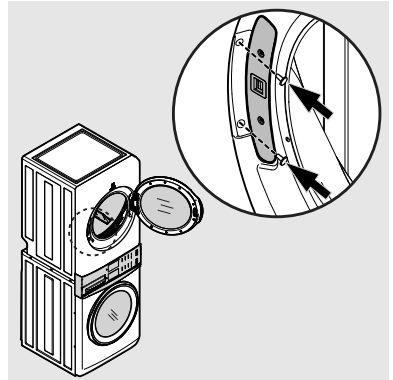

Verify Reversed Dryer Door Operation

1. Test the door for freely swinging, smooth operation and a secure latch when closed.
2. Plug in the dryer and close the door. Start a test cycle: the drum should tumble until the door is pulled open or the cycle is paused or canceled.

Settings Chart - 7300 series

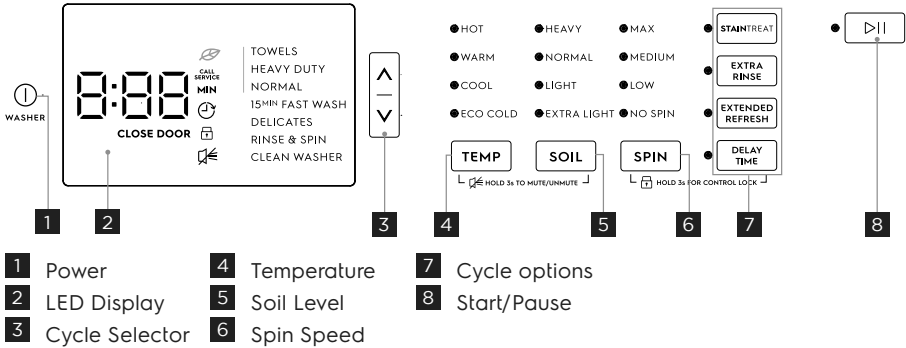

These temperature, spin speeds, soil levels and options are available with the following cycles:

CYCLE SELECTIONS

	TOWELS	HEAVY DUTY	NORMAL	15 MIN FAST WASH	DELICATES	RINSE & SPIN	CLEAN WASHER
--	--------	------------	--------	------------------	-----------	--------------	--------------

TEMP

HOT	✓	✓	✓	✓		✓	
WARM	✓	✓	✓	✓	✓	✓	
COOL	✓	✓	✓	✓	✓	✓	
ECO COLD	✓	✓	✓	✓	✓	✓	

SOIL

HEAVY	✓	✓	✓	✓	✓	✓	
NORMAL	✓	✓	✓	✓	✓	✓	
LIGHT	✓	✓	✓	✓	✓	✓	
EXTRA LIGHT	✓	✓	✓	✓	✓	✓	

SPIN

MAX	✓	✓	✓	✓		✓	
MEDIUM	✓	✓	✓	✓	✓	✓	
LOW	✓	✓	✓	✓	✓	✓	
NO SPIN	✓	✓	✓	✓	✓	✓	

OPTIONS

STAIN TREAT	✓	✓	✓	✓	✓		
EXTRA RINSE	✓	✓	✓	✓	✓	✓	
EXTENDED REFRESH	✓	✓	✓	✓	✓	✓	
DELAY TIME	✓	✓	✓	✓	✓	✓	✓
CONTROL LOCK	✓	✓	✓	✓	✓	✓	✓
MUTE/UNMUTE	✓	✓	✓	✓	✓	✓	✓

✓ = Available selections. □ = Factory presets. ■ = Non-modifiable presets.

This manual covers many models and not all cycles, options, or features listed are available on every model. Consoles shown above for reference only. Your model may differ.

Settings Chart - 7600 series

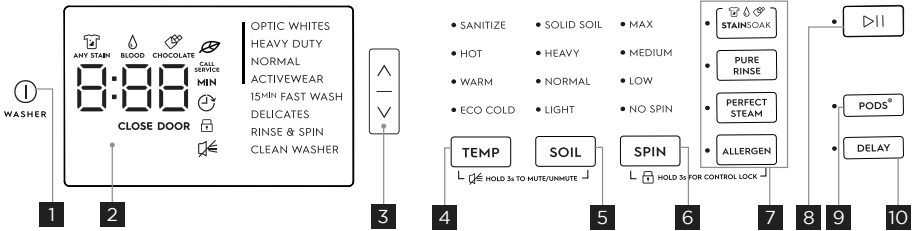

- 1** Power
- 2** LED Display
- 3** Cycle Selector
- 4** Temperature
- 5** Soil Level
- 6** Spin Speed
- 7** Cycle Options
- 8** Start/Pause
- 9** PODS®
- 10** Delay

These temperature, spin speeds, soil levels and options are available with the following cycles:

CYCLE SELECTIONS

	OPTIC WHITES	HEAVY DUTY	NORMAL	ACTIVEWEAR	15 MIN FAST WASH	DELICATES	RINSE & SPIN	CLEAN WASHER
--	--------------	------------	--------	------------	------------------	-----------	--------------	--------------

CYCLE SETTINGS	TEMP								
	SANITIZE	✓	✓	✓					
	HOT	✓	✓	✓	✓			✓	
	WARM	✓	✓	✓	✓	✓	✓	✓	
	ECO COLD	✓	✓	✓	✓	✓	✓	✓	
	SOIL								
	SOLID SOIL	✓	✓	✓	✓	✓			
	HEAVY	✓	✓	✓	✓	✓	✓	✓	
	NORMAL	✓	✓	✓	✓	✓	✓	✓	
	LIGHT	✓	✓	✓	✓	✓	✓	✓	
SPIN									
MAX	✓	✓	✓	✓	✓			✓	
MEDIUM	✓	✓	✓	✓	✓	✓	✓	✓	
LOW	✓	✓	✓	✓	✓	✓	✓	✓	
NO SPIN	✓	✓	✓	✓	✓	✓	✓	✓	
CYCLE OPTIONS	OPTIONS								
	STAINSOAK (Any Stain)	✓	✓	✓	✓	✓	✓		
	STAINSOAK (Blood)	✓	✓	✓	✓	✓	✓		
	STAINSOAK (Chocolate)	✓	✓	✓	✓	✓	✓		
	PURE RINSE	✓	✓	✓	✓	✓	✓	✓	
	PERFECT STEAM	✓	✓	✓	✓	✓	✓	✓	
	ALLERGEN	✓	✓	✓	✓	✓	✓		
	DELAY	✓	✓	✓	✓	✓	✓	✓	✓
	CONTROL LOCK	✓	✓	✓	✓	✓	✓	✓	✓
	MUTE/UNMUTE	✓	✓	✓	✓	✓	✓	✓	✓
PODS®	✓	✓	✓	✓	✓	✓	✓	✓	

✓ = Available selections. ◻ = Factory presets. ◼ = Non-modifiable presets.

Cycle Selection

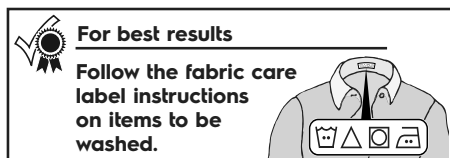

Press the **power** button to turn on the unit. Then press the cycle selector in either direction to scroll to the desired cycle and the indicator light for the selected cycle illuminates.

The estimated cycle time will appear on the LED display and indicator lights adjacent to the default settings (water temperature, final spin speed, and soil level) illuminate for the cycle selected. See *Washer Settings Chart* for the default settings for each cycle.

Cycle settings and cycle options can be changed using the **temp**, **spin** and **soil** buttons. See *Cycle Settings* and *Cycle*

Options for detailed directions and descriptions of available settings.

To change the cycle once the cycle has begun, press **power** to turn the machine off. Press **power** to turn the machine on again and select a new cycle, then press **start/pause**.

Press **start/pause** to stop the cycle.

NOTE

- Pressing the cycle selector button without first powering off and on the unit will not change the cycle.
- Selecting the PODS® setting may increase **fast wash** time by several minutes.
- Deselect **pure rinse** (7600) or **extra rinse** (7300) for a spin only cycle. Select **no spin** for a drain only cycle.

Cycles

LOAD	LOAD TYPE	CYCLE DESCRIPTION
OPTIC WHITES	White loads	<ul style="list-style-type: none"> SmartBoost action longer agitation optimized temperatures
HEAVY DUTY	Large heavily soiled loads	<ul style="list-style-type: none"> longer agitation aggressive cleaning motion higher temperatures
NORMAL	Mixed loads, cotton	<ul style="list-style-type: none"> moderate agitation moderate cleaning motion most energy efficient
ACTIVWEAR	Highly solid lightweight synthetic apparel	<ul style="list-style-type: none"> longer agitation mild cleaning motion extra rinse
TOWELS	Towels	<ul style="list-style-type: none"> long agitation higher temperatures
FAST WASH 15 min.	Small lightly soiled loads (3-5 pieces)	<ul style="list-style-type: none"> aggressive cleaning motion extra rinse
DELICATES	Small lightly soiled loads (delicate fabrics)	<ul style="list-style-type: none"> shorter agitation gentle cleaning motion lower temperatures lower spin speeds
RINSE & SPIN	Rinse and spin only (cold rinse or add fabric softener)	<ul style="list-style-type: none"> cold temperature
CLEAN WASHER	See "Care and Cleaning" section of the manual	

*All cycles not available on every model. See Settings charts

Cycle Settings

Washing Temperature

The appropriate washing temperature will automatically be indicated for the cycle selected. To change the preset temperature, press the **temp** button to scroll to the desired setting. Select a wash water temperature according to fiber content, colorfastness and soil level.

To protect your fabrics, not all temperatures are available with every cycle. If a temperature is not available for the cycle, it cannot be selected by pressing the **temp** button.

The temperature selected for the cycle will be remembered and recalled each time that cycle is selected in the future.

All wash water temperatures are automatically regulated to maximize detergent effectiveness and improve washing performance. The water heater setting and its distance from the washer, water usage in other parts of the home, and seasonally low ground water temperature in some geographic areas can affect water temperature.

sanitize (on select models)

Use the sanitize setting to clean and sanitize heavily soiled, colorfast fabrics including towels, bedding, cloth diapers, and children's clothing.

It is recommended that you set your water heater to 120°F (49°C) or higher to ensure proper performance during this cycle. If the setting is lower or the load is extra large, the cycle time may be extended.

When used with the **heavy duty, towels**, and **optic whites** cycles, the **sanitize** setting will kill 99.9% of bacteria with no carryover of bacteria between loads. No bleach or harsh chemicals are needed, but higher temperatures are required. Please check fabric care labels to prevent damage.



NOTE

The **heavy duty, towels**, and **optic whites** with **sanitize** setting cycles have been designed to meet the requirements of NSF P172 protocol for sanitization efficacy.



NSF Protocol P172
Sanitization Performance of Residential
and Commercial, Family-Sized Clothes
Washers



NOTE

If the voltage at your outlet is under 110v, the internal heater may not adequately heat the wash water. If the cycle is interrupted while the water is heating, the final temperature of the wash water may be lower and sanitation may be reduced.

The wash water is heated by an internal boost heater to a maximum of 152°F (67°C) as the load tumbles. Cold water is added to cool down the load prior to drain and spin.

As a precaution, the washer door remains locked when the water temperature reaches 130°F (55°C)



NOTE

If the wash cycle is paused or canceled while the internal drum temperature is above 130°F (55°C), the door will remain locked until it cools. You may manually perform a rinse & spin cycle to cool the internal temperature sooner.

allergen (on select models)

Removes dust mites and dander from household objects. The temperature does increase on this setting.



NOTE

The **heavy duty, optic whites** and **towels** cycles with the **allergen** option selected have been designed to meet the requirements of the NSF P351 protocol for allergen reduction efficacy. These cycles and settings will kill dust mites and eliminate at least 95% of pet dander. Since higher temperatures are required, please check fabric care labels to prevent damage.



NSF Protocol P351
Allergen Reduction Performance
of Residential and Commercial,
Family-Sized Clothes Washers

hot

Use this setting for heavily soiled white or colorfast cottons and blends.

warm

Use this setting for normally soiled white or colorfast cottons or blends.

cool (on select models)

Some warm water will automatically blend with cold tap supply to achieve a precise cold. Use this setting for lightly soiled non-colorfast items, knits, delicates, and hand washables.

eco cold

Wash and rinse temperatures are equivalent to temperature of cold tap supply. Use this selection for fabrics and colors that are prone to dye transfer. For use with cold water  detergents.

**NOTE**

The washer will ALWAYS use a small amount of HOT water to dissolve the pack when the **PODS**® option has been selected.

PODS® is a registered trademark of Procter & Gamble Company, Cincinnati OH, used under license by Electrolux.

Soil level

Adjust the wash time based on the soil level of each load. **Solid soil** (on select models), **heavy**, **normal**, **light** and **extra light** (on some models) soil levels are available.

Spin speed

Max (on select models), **high**, **medium** and **low** (on some models) spin speeds are available for each cycle. The spin speed and/or duration of final spin vary from model to model and cycle to cycle.

Increasing the spin speed will extract more water, decrease drying time and conserve energy. Decreasing the spin speed will reduce wrinkling.

Select **low** spin speed (on some models) to gently spin items that should be line dried.

Use **no spin** to omit the final spin at the end of the cycle. The load will be very wet. Remove items from the wash drum to drip dry or select a spin only cycle to remove excess water at a more convenient time. See Cycle Selection for Spin Only option.

Cycle Options

The default options for each cycle will automatically be chosen when a cycle is selected. To protect fabrics, not all options are available for all cycles. If an option is not available for a cycle, the indicator will not light.

Selecting Options

Press an option button to select the desired options for a wash cycle.



Options vary according to model.

**NOTE**

If changes to the settings or options are attempted after the cycle starts, you will hear several beeps when the buttons are pressed. To change settings or options, press **start/pause**, make the new selections and press **start/pause** again.

All settings or options selected for the cycle, except **sanitize** (on select models), **perfect steam**™ (on select models), allergen (on select models) and stain treatment options, will be remembered and recalled each time that cycle is selected in the future. To return to factory settings, press and hold **soil** and **spin** buttons at the same time and hold for **3** seconds until the confirmation signal sounds. To prevent unintentional and accidental exposure of delicate material to excess heat or unexpected steam, the **sanitize**, **perfect steam**™, **allergen**, and all stain treatment options will need to be reselected each time.

Stain Treatment Options (on select models)



Your washer is equipped with powerful stain treatment tools. Depending on your model, use one of the options below to deal with tough stains on your garments. See step 5 in the *Operating the Washer* section in this manual for details on adding stain additives to the dispenser.

StainTreat (7300 series)

Select this option to add a short initial wash period to available cycles using the stain treatment additives in the **stain soak/treat** compartment. After the stain wash phase, the load will automatically advance to the main wash cycle.

StainSoak (7600 series)

Press the Stain Soak button to select the option, then press the Stain soak button again to choose one of the following described stain types. During the wash cycle, stain treatment and detergent circulate during the agitating load for approximately 20 minutes. SmartBoost pump technology mixes the stain treatment and detergent before the washer advances to the main wash cycle.

- **Any Stain**  Recirculating wash solution will be heated by boost heater.
- **Blood**  Recirculating wash solution will NOT be heated by boost heater to prevent setting blood stains.
- **Chocolate**  Stain wash time is extended with additional heating by boost heater.

perfect steam™ (on select models)

Select this option to add approximately 20 minutes of tumbling in steam.

NOTE

- Steam may not necessarily be visible inside drum during a steam wash cycle.
- Steam may not be present during entire steam wash cycle.



IMPORTANT

- If steam is selected, rinse temperatures will be elevated.
- If the wash cycle is paused or canceled during a steam cycle, the door will remain locked until it cools. You may manually perform a rinse & spin cycle to cool the internal temperature sooner.
- During a steam cycle, steam exiting from the rear vent of the washer is normal and not cause for alarm.

Wash Cycle Options

extra rinse (on select models)

Use this option when additional rinsing is desired to remove excess dirt and detergent. It is recommended for heavily soiled loads or if household members have sensitive skin.

pure rinse (on select models)

Use this option to reduce detergent residues and fragrances that can irritate skin which rinses cleaner than the extra rinse cycle.

extended refresh (on select models)

Select **extended refresh** if you will be unable to remove the load right after the cycle is complete. The washer recognizes the load has sat too long and will do a rinse and spin to keep the load fresh for up to 12 hours. When you are ready to remove the load during the **extended refresh** segment, you must press **power** to end the cycle and open the door.

PODS® (on select models)

Select this option when using a detergent pack in a model equipped with a **PODS®** button (on select dispenser only). This option will divert the flow of water to the detergent pack compartment optimizing the detergent pack performance.

PODS® is a registered trademark of Procter & Gamble Company, Cincinnati OH, used under license by Electrolux.

Control options

7300 Series

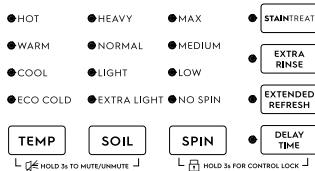

7600 Series

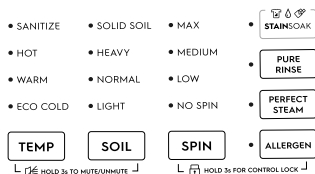
control lock 

To lock or unlock the controls between cycles:

For 7300 Series: Press **spin** and **delay time** for 3 seconds.

For 7600 Series: Press **spin** and **allergen**.

The control lock icon will show on the LED display. Use this feature to reduce the likelihood of accidental operation by children. **Washer cycles will not run when control lock is activated.**

delay time 

Use **delay** or **delay time** to delay the start of the washing cycle from 30 minutes to 12 hours. To turn on the delay time option, press **delay** or **delay time** and keep pressing to scroll through for the desired amount of time delay and press **start**. The **delay time** icon illuminates on the LED display indicating that the **delay time** option is activated. The time begins counting down on the LED display once the washer **start/pause** button is pressed.

Chime

A signal will sound at the end of each cycle (and periodically during **extended refresh**) if option is activated.

To mute or unmute the chime, press and **hold** the **temp** and **Soil** buttons for **3 sec**.

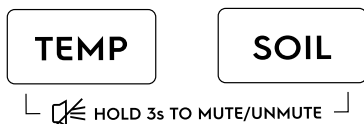
Other Features
LED Display

Icons may vary according to model.

The estimated total cycle time will be displayed when the cycle is selected. The time may increase if water pressure is low, over-sudsing occurs or the load becomes unbalanced. The approximate time remaining will be displayed during the cycle. **The eco, control lock, close door, mute (some models), and delay time will also appear on this LED display.**

Eco indicator 

The **eco** symbol will light up on the LED display to indicate that the selected combination of temperature, spin speed and options are eco friendly.

Oversuds Protection

A situation where over-sudsing has been detected by the washer will result in the washer requiring additional rinses until the suds have been cleared. Each extra rinse the washer performs to clear the suds will add approximately 5 minutes to the cycle duration. The LED will display "SU" followed by "dS" and then the remaining cycle time (0 min) for 60 seconds and then repeat. Press **cancel** to turn off the alert message. The washer will continue to perform rinse cycles until suds are dissolved.



Reversed Hose Detection

If condition is detected where the inlet hoses have been installed incorrectly (hot supply to cold inlet and cold supply to hot inlet), the washer will alert you. The LED will display "HO" followed by "SE" and then the remaining cycle time (0 min) for 60 seconds and then repeat. Acknowledge the reversed hose condition by pressing the cancel button. Shut off each water supply valve and attach each supply hose to the correct inlet connection on the washer.



Drum Light (on select models)

The drum light will come on whenever the door is opened to illuminate the drum during loading and unloading. Closing the door turns off the light. The drum light will automatically turn off if the door is left open more than 3 minutes.

Reversible Door

Your washer may be equipped with a reversible door. The door can be hinged on the right or left side.

Trapped Item Detection

If an item is detected to be trapped between the door and the door gasket, the washer will pause the cycle and play an alert chime. The LED will display a loop of "CLEAR door" as shown below until the cancel button is pressed. Press the cancel button to unlock the door and remove the trapped item, then close the door and restart the cycle.

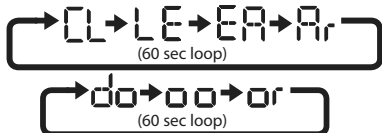

Door Stand Ventilation

Help prevent odor buildup and reduce humidity between washes by utilizing your washer's door stand ventilation feature.

Open the door, locate the stand below the door latch and rotate the stand counter-clockwise to unlock it.

NOTE

If unable to rotate the stand by hand, a coin or flat blade screw driver can be used.

The stand is spring loaded and will extend. Rotate it clockwise to lock in the extended position.

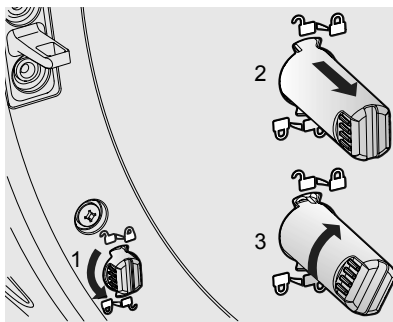

To disengage the stand, rotate to unlock, push the stand in and rotate to lock position.

NOTE

If door stand will not turn to locked position, fully turn it to unlock position and try to lock again.

48 DRYER CONTROLS AND SETTINGS

Settings Chart - 7300 series

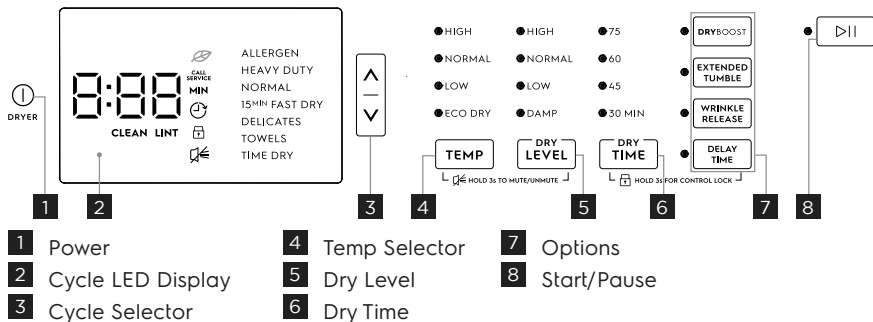

These temperature, dryness levels and options are available with the following cycles:

CYCLE SELECTIONS

	ALLERGEN	HEAVY DUTY	NORMAL	15 MIN FAST DRY	DELICATES	TOWELS	TIME DRY
--	----------	------------	--------	-----------------	-----------	--------	----------

TEMPERATURE (temp)

HIGH	■	■		■		■	■
NORMAL		■	■	■		■	■
LOW			■	■	■	■	■
ECO DRY			■	■	■		■

DRYNESS

HIGH	■	■	■			■	
NORMAL		■	■		■	■	
LOW			■		■	■	
DAMP			■		■	■	

Dry Time

75 Min							■
60 Min							■
45 Min							■
30 Min							■

OPTIONS

DRY BOOST	■	■	■	■	■	■	■
EXTENDED TUMBLE	■	■	■	■	■	■	■
WRINKLE RELEASE	■	■	■	■	■	■	■
DELAY TIME	■	■	■	■	■	■	■
CONTROL LOCK	■	■	■	■	■	■	■

✓ = Available selections. ■ = Factory presets. ■ = Non-modifiable presets.

This manual covers many models and not all cycles, options, or features listed are available on every model. Consoles shown above for reference only. Your model may differ.

Settings Chart - 7600 series

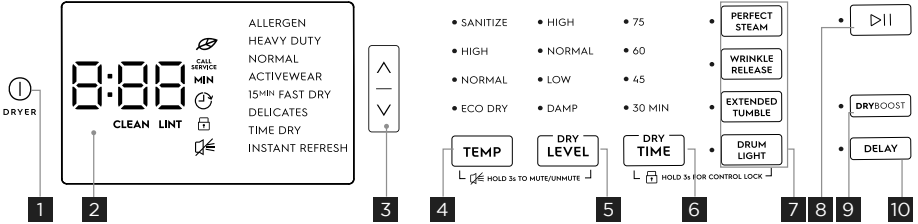

- 1** Power
- 2** Cycle LED Display
- 3** Cycle Selector
- 4** Temp Selector
- 5** Dry Level
- 6** Dry Time
- 7** Options
- 8** Start/Pause
- 9** Dry Boost
- 10** Delay

These temperature, dryness levels and options are available with the following cycles:

CYCLE SELECTIONS							
ALLERGEN	HEAVY DUTY	NORMAL	ACTIVE WEAR	15 ^{MIN} FAST DRY	DELICATES	TIME DRY	INSTANT REFRESH

TEMPERATURE (temp)								
SANITIZE	✓	✓		✓	✓		✓	
HIGH	✓	✓		✓	✓		✓	✓
NORMAL		✓	✓	✓	✓	✓	✓	
ECO DRY			✓	✓	✓	✓	✓	
DRYNESS								
HIGH	✓	✓	✓			✓		
NORMAL		✓	✓	✓		✓		
LOW		✓	✓	✓		✓		
DAMP			✓			✓		
DRY TIME								
75 Min							✓	
60 Min							✓	
45 Min							✓	
30 Min							✓	
OPTIONS								
PERFECT STEAM	✓	✓	✓	✓		✓		✓
WRINKLE RELEASE	✓	✓	✓	✓	✓	✓	✓	✓
EXTENDED TUMBLE	✓	✓	✓	✓	✓	✓	✓	✓
DRUM LIGHT	✓	✓	✓	✓	✓	✓	✓	✓
DELAY	✓	✓	✓	✓	✓	✓	✓	✓
CONTROL LOCK	✓	✓	✓	✓	✓	✓	✓	✓
DRY BOOST	✓	✓	✓	✓	✓	✓	✓	✓

✓ = Available selections. □ = Factory presets. ■ = Non-modifiable presets.

Cycle Selection

Selecting the right cycle to save energy

This dryer has been specifically designed with options to help you save energy and at the same time utilize the optimal drying setting for your clothing.

The energy efficiency rating is based on the Normal Cycle using the Normal temperature setting and the normal dryness level.

Some cycles save more energy than others. Cycles that use the least amount of heat save the most energy and display the leaf icon  on the console. Use the lowest heat setting (auto and timed dry cycles) and less dry setting (auto dry cycles) to save on energy and prevent over drying your clothing.

Press the **power** button to turn on the unit. Turn the cycle selector in either direction or repeatedly press the cycles button (depending on your model) to scroll to the desired cycle. The indicator light for the cycle selected will be illuminated and the estimated drying time for Auto Dry cycles or the actual drying time for Time Dry cycles will be displayed on the LED display screen.

Default settings and options will automatically be indicated for the cycle selected. In most cases cycle settings and options can be changed. See *Cycle Settings*, *Cycle Options*, and *Setting Charts* for more details.

To change the cycle once it has begun, press the **cancel** button before selecting a new cycle. **Turning the cycle selector ring or pressing the cycles button WILL NOT change the cycle.**

Auto dry cycles

Auto dry cycles take the guesswork out of selecting the correct drying time for each load. Moisture sensors sense the moisture level of the load as it tumbles through the heated air. With auto dry cycles, the load will automatically be dried at the selected temperature to the desired dryness level.

Auto dry cycles save time and energy and protect fabrics. When the load has reached the selected dryness level, it will continue to tumble, unheated, during a cool down period. This helps reduce wrinkling and makes items easier to handle during unloading.

NOTE

Initial cycle times for auto dry cycles are only estimates, the actual drying time may differ slightly from the time displayed.

Drying times vary depending on size and dampness of the load and fabric type. If the load is too small or almost dry, the moisture

sensors may not detect enough moisture to continue the cycle and the cycle may end after a few minutes. If this occurs, then select the **time dry** cycle to dry such loads.

Room temperature and humidity, type of installation and electrical voltage or gas pressure can also affect drying time.

NOTE

Models equipped with the **Predictive Dry** feature use the first 90 seconds of Auto Dry cycles to sense the load in the dryer. **During this 90 second period the LED display will show 3 circling lines.** When the sensing is complete, the LED display will show the remaining cycle time in minutes and accurately count down to the end of the cycle.

Timed dry cycles

The timed drying cycles allow the selection of exact drying times. The **time dry** cycle allows the option to select drying time settings ranging from **30** to **75** minutes (depending on the model). Various drying times and temperature settings can be selected when using this cycle.

The **fast dry** cycles have preset times of **15** minutes with a preset temperature of **high**.

Dryness levels will not be an available option when using either of the timed drying cycles.

WARNING

FIRE HAZARD

To avoid fire hazard, DO NOT use heat to dry items containing feathers or down, foam rubber, plastics similarly textured, rubber-like materials. Use the **time dry** cycle and the **eco dry** (no heat) setting.

Cycles

LOAD	LOAD TYPE	CYCLE PRESET
ALLERGEN	Allergen removal (not for items prone to heat damage)	<ul style="list-style-type: none"> high temperature* high dryness*
HEAVY DUTY	Large loads and durable fabrics (such as towels, jeans and overalls)	<ul style="list-style-type: none"> high temperature high/normal dryness
NORMAL	Everyday loads (cottons, linens and sheets)	<ul style="list-style-type: none"> normal temperature normal/low dryness
ACTIVWEAR (select models)	Lightweight synthetic athletic apparel (synthetic athletic fabrics and stretch fabrics)	<ul style="list-style-type: none"> eco dry temperature low dryness
TOWELS (select models)	Large loads and durable fabrics (such as towels, jeans and overalls)	<ul style="list-style-type: none"> high temperature normal dryness
15 min. FAST DRY	Small loads of 3 to 5 garments	<ul style="list-style-type: none"> high temperature
DELICATES	Knit fabrics and delicates	<ul style="list-style-type: none"> low temperature normal dryness
TIME DRY	Manually set drying time, heat and dry level for any type of load	<ul style="list-style-type: none"> normal temperature 30-75 minutes time
INSTANT REFRESH (select models)	Refresh fabrics, remove odors and reduce static by injecting steam into clothing.	<ul style="list-style-type: none"> high temperature* perfect steam™

* Settings can not be changed from preset on select models. See Cycle selections charts for details.

NOTE

It is not recommended to use fabric softener sheets with steam cycles or steam options as it may cause staining on clothes.

With exception of the **perfect steam™**, adjustments made to cycle settings and options will be remembered and recalled each time that cycle is selected in the future.

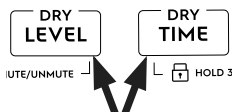

Cycle Settings

To set or change the drying temperature, dryness level, or drying time press the **temp**, **dryness** or **time dry** buttons to scroll to the desired settings. The indicator light for each setting will be illuminated when selected.

Press the dry level and dry time buttons at the same time until a tone sounds to return to factory settings.

Drying Temperature (temp)

To change the temperature, press the **temp** button to scroll to the desired setting.

NOTE

To change a cycle setting once the cycle has begun, press the **start/pause** button, make the new selection and press **start/pause** again.



For best results

Follow the fabric care label instructions on items to be dried.

sanitize (on select models)

Recommended for durable fabrics and towels. Use this selection to remove harmful bacteria from your clothing or other items where sanitization is desired. This option will kill 99.9% of bacteria using a higher temperature required to kill bacteria. Please check fabric care labels to prevent damage.

To protect your fabrics, not all temperatures or dryness levels are available with every cycle. If a temperature or dryness level is not appropriate for the cycle, it cannot be selected and will not be lit when scrolling through the settings.

52

DRYER CONTROLS AND SETTINGS

high

Recommended for most cotton fabrics.

normal

Recommended for wrinkle free, easy care, lightweight fabrics and bulky loads.

low (on select models)

Recommended for delicate fabrics.

eco dry (no heat)

This setting should only be used with a time dry cycle to dry items containing feathers, down, foam rubber, plastics or rubber-like materials; to refresh clothing, stuffed animal, pillows or blankets; and to dust draperies.

Dryness level (dry level)

To set or change the dryness level, press the **dry level** button to scroll to the desired setting.

The dryness levels include **high**, **normal**, **low**, and **damp**.

Occasionally a load may seem too damp or over-dried at the end of the cycle. Select **high** to increase drying time for similar loads in the future. Select **low** to decrease drying time for similar loads.

Select **damp** for items you wish to partially dry before hanging or ironing.

Drying time (dry time)

Manually select or change the drying time for a **time dry** cycle (on select models) by pressing the **dry time** button to scroll through the available options. Time dry options include **30**, **45**, **60** and **75** minutes (dependent on model).

All actual or predicted dry times will count down on the LED display.

Cycle options

Chose desired options. See Cycle Selection Chart.

NOTE

To change a cycle option once the cycle has begun, press the **start/pause** button, make the new selection and press **start/pause** again.

To protect your fabrics, not all options are available with every cycle. If an option is not available for a cycle, the indicator will not light



perfect steam™ (on select models) The **perfect steam™** option injects steam into the clothing prior to cool down to reduce wrinkling, ironing and static cling.



NOTE

It is not recommended to use fabric softener sheets with steam cycles or steam options as it may cause staining on clothes.

dry boost

This option increases the drying effectiveness for heavier fabrics or bulky loads by increasing the drying temperature by less than 20°F (>1°C). (Varies based on cycle selection).

leaf icon

This icon will appear on the console when the dryer is using energy efficient settings. These settings use less heat and longer cycle times to dry. The dryer will always default to the energy efficient Normal cycle with the leaf icon displayed.

wrinkle release

The **wrinkle release** option helps prevent wrinkles and tangling by tumbling the dry load without heat for 5 minutes out of every 10 minutes. The 5 minutes on and 5 minutes off is repeated for a total 45 minutes. A chime will sound after each tumble as a reminder to remove the dried load.



NOTE

When **extended tumble** and **wrinkle release options are both selected** the amount of time the load will tumble without heat will increase to a period of up to 75 minutes.

extended tumble

Select the **extended tumble** option if the dried load might not be removed promptly at the end of the cycle. The dried load will tumble continuously without heat for 30 minutes. A chime will sound periodically to remind you to remove the dried load.

delay time

Use **delay time/delay** to delay the start of the drying cycle to a time convenient to your schedule or during off-peak energy hours. The start of any cycle can be delayed for

30 minutes to 12 hours. After selecting the delay time option, use the cycle button. Press delay or delay time and keep pressing to scroll to the desired delay time and press **start**. The **delay time** icon will illuminate on the LED display to indicate the **delay time** option is activated. The delay time will begin counting down on the LED display once activated.

control lock 

To lock or unlock the controls between cycles on the 7300 series, hold the **dry time** and **delay time** buttons for 3 seconds.

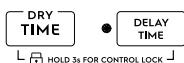

To lock or unlock the controls between cycles on the 7600 series, hold the **dry time** and **drum light** buttons for 3 seconds.

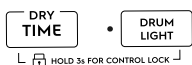

The control lock icon will show on the LED display. To unlock the controls scroll to the control lock option again and press **select**. Use this feature to reduce the likelihood of accidental operation by children. **Dryer cycles will not run when Control Lock is activated.**

chime

A signal will sound at the end of the cycle (and periodically during **extended tumble** or **wrinkle release**). To mute or unmute the chime, press and hold the **Temp** and **Dry Level** button for **3** seconds.



Other Features

LED display

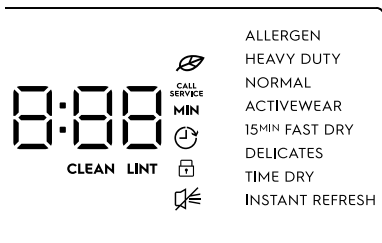

Icons may vary according to model.

The estimated cycle time, the actual time for **time dry**, or the **delay time** countdown

will be displayed when the cycle is selected. Once the cycle has started, the estimated remaining time will be displayed for the remainder of the cycle.

Models equipped with the Predictive Dry feature use the first 90 seconds of Auto Dry cycles to sense the load in the dryer. During this 90 second period the LED display shows 2 circling lines. When the sensing is complete, the LED display shows the remaining cycle time in minutes and accurately count down to the end of the cycle.

Delay time, leaf, control lock, mute icons (select models) and **CLEAN LINT** will also appear on this LED display when activated.

Drum light (on select models)

The drum light will come on whenever the door is opened to illuminate the drum during loading and unloading. Closing the door turns off the light. The drum light will automatically turn off if the door is left open more than 3 minutes. Select the **drum light** option to enable or disable the drum light.

Reversible door

The dryer is equipped with a reversible door. The door can be hinged on the right or left side.

 **NOTE**

For step-by-step instructions on door reversal, refer to the Installation sections of this guide.

LuxCare™ Lint Shield filter

The dryer is equipped with a clamshell style LuxCare™ Lint Shield filter.

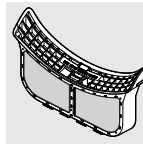

 **WARNING**

Clean the filter after every load. A **CLEAN LINT message** will appear when the unit is powered on as a reminder to clean the lint filter before starting a cycle.

 **WARNING**

Clean the filter after every load. A **CLEAN LINT message** will appear when the unit is powered on as a reminder to clean the lint filter before starting a cycle.



Operating the Washer



CAUTION

ENTRAPMENT and TIP-OVER HAZARD

DO NOT leave the door open if there are small children or pets present. An open door could entice children to hang on the door or crawl inside the washer.

STEPS	TIPS	IMPORTANT
<p>1. Sort laundry into loads that can be washed together.</p>	<ul style="list-style-type: none"> Sort by recommended cycle and water temperature. Separate white, light, and colorfast items from dark and non-colorfast items. Separate items that shed lint from items that attract lint. Casual, synthetic, knit, and corduroy items will pick up lint from towels, rugs, and bedspreads. Separate heavily soiled items from lightly soiled items. Separate lacy, sheer, loosely knit, or delicate items from durable items. 	<p>DO NOT machine wash items containing fiberglass. Small particles of fiberglass left in drum may transfer to fabrics in other loads and cause skin irritation and/or damage to fabrics.</p> <p>DO NOT wash water resistant and water repellent type clothing or other materials</p>
<p>2. Prepare items for washing.</p> 	<ul style="list-style-type: none"> Empty pockets. Brush off lint and dirt. Shake out rugs and beach towels. Close zippers, fasten hooks, button buttons, and tie strings/sashes. Remove non-washable trims and ornaments. Place delicate and small items (bras, hosiery, etc.) in a mesh bag (not included). 	<p>Mend rips and tears to prevent further damage during washing.</p> <p>Turn knit items inside out to prevent pilling.</p>
<p>3. Pretreat stains and heavy soil.</p>	<p>See stain treatment function in <i>Cycle Options</i> for your particular model or <i>Stain Removal Guide</i> for more information.</p>	
<p>4. Add laundry load to wash tub.</p> 	<ul style="list-style-type: none"> Combine large and small items in a load. Load large items first. Large items should not be more than half the total wash load. Washing single items is inefficient and may cause an out-of-balance load. Add 1 or 2 similar items to help balance load. Wash single heavy items (comforter, sleeping bag, etc.) separately. The washer can be fully loaded, but the items should not be tightly packed. The door should close easily. 	<p>DO NOT overload the washer.</p> <p>DO NOT WASH: Water resistant and water repellent clothing or other materials.</p>

STEPS	TIPS	IMPORTANT
5. Add wash products to dispenser.	<ul style="list-style-type: none"> • Water conditioners, detergent boosters and enzyme products may be added with detergent • See <i>Adding Laundry Products</i> for detailed information on the use of the product dispensers. • See <i>Adding Laundry Products</i> for detailed information on the use of various wash products (detergent, bleach, stain treatment, fabric softener, etc). 	<p>Follow manufacturer's instructions and recommendations when using wash products.</p> <p>Open and close the dispenser drawer slowly. Closing the drawer too quickly could result in early dispensing of the bleach or fabric softener.</p>
6. Select the cycle and settings for the load.	<ul style="list-style-type: none"> • See <i>Cycle Selection, Cycle Settings, and Cycle Options</i> for detailed descriptions of cycle controls. • See <i>Cycle Setting Charts</i> to determine which settings are available for each cycle. • To provide the best care, not every setting or option is available with every cycle. If a setting or option is not available for the cycle selected, the indicator will not light 	<p>Follow fabric care label instructions on items to be washed.</p> <p>Make sure that the PODS® option is selected when using models that have a separate detergent pack compartment. See <i>Adding Laundry Detergent to the Adaptive Dispenser™</i></p>
7. Start the washer.	<ul style="list-style-type: none"> • Close the door and press start/pause. The washer will not operate with the door open. "CLOSE DOOR" will be displayed as a reminder to close the door. • To add a forgotten item to the washer any time during the wash portion of the cycle, press start/pause. When the door unlocks, open the door, add the item, close the door and press start/pause to resume cycle. • To change settings or options after the cycle has begun, press start/pause, change the settings, and then press start/pause. If the cycle is not paused first, the unit will emit several beeps when the buttons are pressed but no changes to the cycle will be applied. • To change the cycle once the cycle has begun, press cancel to cancel the cycle, select the new cycle, and press start/pause to begin the new cycle. Changing a cycle selection without canceling the current WILL NOT change the cycle. • To cancel a cycle, press cancel. • A signal will sound at the end of the cycle if the chime option is not set to mute. 	<p>DO NOT force door open. As a safety measure, the door will automatically lock during the entire wash cycle. Pause or cancel the wash load to unlock the door.</p> <p>If the cycle is interrupted during spin, the door lock will not release until the tub has stopped spinning.</p> <p>If the water level is above the bottom of the door opening/flexible door gasket, the lock will not release.</p>
8. Remove items from washer when cycle has ended.	<ul style="list-style-type: none"> • Remove items when the cycle ends and place in dryer, line dry or dry flat as directed on the fabric care label. 	<p>Excess wrinkling, color transfer or odors may develop in items left in the washer after the cycle has ended.</p>

Adding Laundry Products Laundry product dispensers

Product dispenser - Adaptive Dispenser™

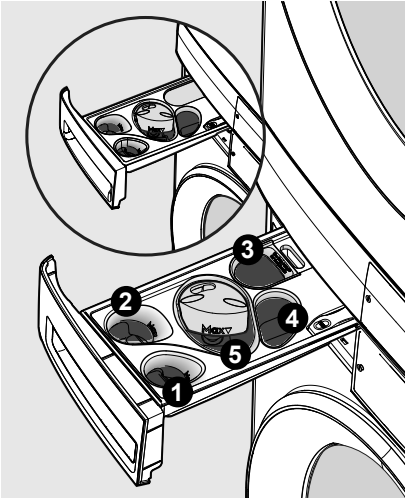

Detergent, stain treatment (on select models), liquid chlorine bleach and liquid fabric softener will be dispensed at the proper times in the cycle.

Use the cap or scoop provided by the detergent manufacturer to measure the amount recommended. Detergent dosage may need to be adjusted for water temperature, water hardness, load size and soil level.



For best results

Use a low-sudsing, high efficiency detergent to prevent over-sudsing in front load washers. Look for this symbol on the detergent label: 

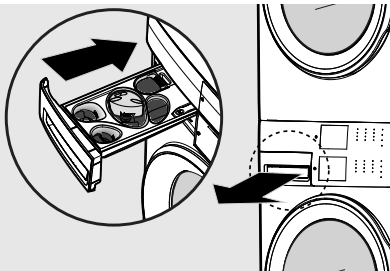

7300 Series

1. Liquid Fabric Softener
2. Liquid bleach
3. No Pods compartment on 7300 series
4. Stain Treat
5. Liquid or Powder Detergent

7600 Series

1. Liquid Fabric Softener
2. Liquid bleach
3. Detergent pack compartment*
4. Stain Soak
5. Liquid or Powder Detergent

*Max. 2 packs per load

Adding Laundry Detergent to the Adaptive Dispenser™



IMPORTANT

DO NOT mix liquids and powders.



CAUTION

Keep detergent packs away from children.

Liquid detergent

- Use the cap or scoop provided by the detergent to add recommended amount of detergent to the detergent compartment. Pour directly into the detergent cup, not over the blue cover.
- Amount of detergent may need to be adjusted for water temperature, water hardness, and load size. Follow manufacturers instructions.

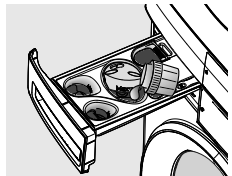

Powder Detergent

- Remove the liquid detergent cup and blue cover before adding powder detergent
- Add powder detergent directly to the powder detergent compartment

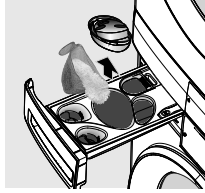

Detergent pack

For 7300 series models

Add detergent pack directly to the empty drum **BEFORE** placing laundry into the unit

- **DO NOT** place detergent packs directly into the detergent drawer. The gel coating may cause the detergent drawer to become clogged.

For 7600 series models

Add the recommended quantity of high efficiency detergent packs to the detergent pack compartment in the dispenser.

- **DO NOT** place more than two packs into the dispenser.
- When using the **fast wash** cycle, only one detergent pack should be used.

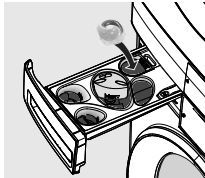

NOTE

From time to time you may see water in the **dispenser**. This is part of the normal operation of the washer.

Adding other wash products

- Color-safe bleach, water conditioner, detergent booster and enzyme products may be added with detergent
- Put liquid products in the **Main Wash - liquid detergent** compartment or powder products in the **Main Wash - powder detergent** compartment

Stain Treatment (on select models)

- For heavily soiled or stained loads, select the Stain option (on select models only - StainTreat, or StainSoak) and add the recommended amount of detergent or stain treatment to stain soak/treat compartment (on select models).
- See *Cycle Options* for information about Stain options for your model.
- See *Stain Removal Guide* in this instruction for additional suggestions.

IMPORTANT

- When using the detergent pack compartment, make sure to select the **PODS®** option before starting the load.
- Once the **PODS®** option has been chosen, the washer will retain the **PODS®** setting until manually changed.
- The washer will **ALWAYS** use a small amount of **HOT** water to dissolve the pack when the **PODS®** option has been selected.



PODS® is a registered trademark of Procter & Gamble Company, Cincinnati OH, used under license by Electrolux.

IMPORTANT

Use of multi-product (detergent plus softener) sheets or color-absorbing sheets **NOT** recommended. They could disable your machine and result in unwarranted repair costs.

Liquid chlorine bleach

- If desired, add liquid chlorine bleach to the compartment labeled **Liquid Bleach** and marked with this symbol:
- **DO NOT** fill above the **MAX** fill line.
- Add color-safe bleach with detergent

Liquid fabric softener

- If desired, pour the recommended amount of liquid fabric softener into the compartment labeled **Fabric Softener** and marked with this symbol:
- **DO NOT** fill above the **MAX** fill line.
- Use of a fabric softener-dispensing ball is not recommended in front load washers.

Operating the Dryer



WARNING

To reduce the risk of fire, electric shock or injury to persons, read the Important Safety Information in this *Use & Care Manual* before operating your dryer.



WARNING

DO NOT operate dryer without lint filter in place.



WARNING

Clean the lint filter after every load.

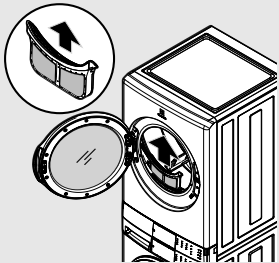
STEPS	TIPS	IMPORTANT
1. Prepare load for drying.	<ul style="list-style-type: none"> • Dry items of similar fabric, weight and construction in the same load. • Separate dark items from light-colored items. Separate items that shed lint from those that attract lint. • Check for stains which may not have been removed in washing. Repeat stain removal process and wash again before drying. Dryer heat may permanently set some stains. • Place delicate, rubber coated, or small items in a mesh bag (not included). • Be sure buckles, buttons and trim are heatproof and won't damage the drum finish. Close zippers; fasten hooks and loop fasteners. Tie strings and sashes to prevent snagging and tangling. 	<p>DO NOT machine wash items containing fiberglass. Small particles of fiberglass left in drum may transfer to fabrics in other loads and cause skin irritation and/or damage to fabrics.</p> <p>DO NOT wash water resistant and water repellent type clothing or other materials.</p>
2. Check that the lint filter is clean and in place.		<p>DO NOT operate dryer without lint filter in place.</p>
3. Load the dryer and close the door.	<ul style="list-style-type: none"> • Load items loosely. The average wet load will fill the drum 1/3 to 1/2 full. Items need room to tumble freely for even drying and less wrinkling. • If desired, place a dryer fabric softener sheet on top of the load at the beginning of the cycle. • When drying large items, dry only two or three items at a time. Fill out the load with smaller items. • For delicate or very small loads, add two or three similar items to improve tumbling action. 	<p>DO NOT overload the dryer. To save energy, time and avoid uneven drying and wrinkling avoid overloading the dryer.</p> <p>DO NOT over-dry. Over-drying can cause wrinkles, shrinkage, lint, and a build up of static electricity.</p>

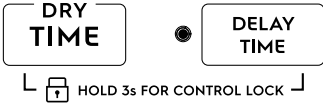
STEPS	TIPS	IMPORTANT
<p>4. Select the appropriate cycle and settings for each load.</p>	<ul style="list-style-type: none"> • See <i>Cycle Selection</i> and <i>Cycle Settings</i> for detailed descriptions of cycle controls. • See <i>Cycle Setting Charts</i> to determine which settings are available for each cycle. • To provide the best care, not every setting or option is available with every cycle. If a setting or option is not available for the cycle selected, the indicator will not light. See <i>Setting Chart</i> for information of available options for each cycle by model. • Adjustments made to most cycle settings will be remembered each time the cycle is selected in the future. When the dryer is powered on, the default cycle will be the normal cycle. Select your desired cycle and previous settings will remain. To return to factory settings, press the dry level button and the dry time button at the same time and hold until the signal sounds. See Dryer Controls and Settings. <div style="text-align: center;">  <p>DRY TIME ● DELAY TIME</p> <p>⌞ [Control Lock Icon] HOLD 3s FOR CONTROL LOCK ⌋</p> </div>	<p>Over-drying can cause wrinkles, shrinkage, lint, harshness, and a build up of static electricity.</p> <p>To prevent unintentional and accidental exposure of delicate material to excess heat or unexpected steam, the sanitize temperature setting and the perfect steam™ option will not be remembered and must be reselected each time.</p>
<p>5. Close the dryer door and start the drying cycle.</p>	<ul style="list-style-type: none"> • To start the drying cycle, close the door and press the start/pause button. • To add an item to the dryer drum, press start/pause. Add the item, close the door and press start/pause to resume the cycle. • To change settings or options after the cycle has begun, press start/pause, change the settings, and then press start/pause. If the cycle is not paused first, the unit will emit several beeps when the buttons are pressed but no changes to the cycle will be applied. • To change the cycle once the cycle has begun, press cancel to cancel the cycle, select the new cycle, and press start/pause to begin the new cycle. Changing a cycle selection without canceling the current WILL NOT change the cycle. • To cancel a cycle, press cancel. 	<p>The dryer will not operate with the door open.</p> <p>When drying a single large or bulky item, such as a comforter, pause the cycle part way through to turn the item “inside out” and maximize drying effectiveness.</p>
<p>6. Remove items when done.</p>	<ul style="list-style-type: none"> • A signal will sound at the end of the cycle if the chime option is not set to mute. • Immediately remove items when the cycle is completed and hang or fold. 	<p>See product manufacturer’s instructions.</p>
<p>7. Clean the lint filter.</p>	<ul style="list-style-type: none"> • See Care and Cleaning section of this instruction. • CLEAN LINT will be displayed at the end of the cycle as a reminder to remove lint from filter. 	<p>ALWAYS REMOVE LINT at the end of the cycle (see warning on previous page).</p>

Dryer

You may or may not hear the following sounds from the laundry center dryer:

- A. **WATER VALVE** (Steam models only.) The flow of water is controlled by electric solenoids. During operation there may be a clicking sound as the valve opens and closes to control the water flow.
- B. **SUSPENSION ROLLERS** The dryer drum is supported by a set of suspension rollers. At times there may be a thumping or rolling sound when the dryer starts. This may happen if the dryer has not been in use for a period of time, or after a heavy load has remained in the dryer drum for an extended period, creating a temporary flat spot on the edge of the roller. The noise should dissipate as the dryer operates and the flat spots smooth out.
- C. **AIR FLOW SYSTEM** Your dryer is equipped with a high volume air handling system. In some installations there may be some sounds associated with air movement throughout the dryer, including the air duct, blower, and exhaust system. This is normal and can vary with load size and type.
- D. **GAS VALVE** (Gas models only.) The flow of gas is controlled by electric solenoids. During operation there may be a clicking sound as the valve opens and closes to control the gas flow.
- E. **GAS BURNER** (Gas models only.) When the burner is operating, there may be sounds generated as the air flow mixes with the gas flame. This noise is normal and will only occur when the gas is ignited in the combustion tube.

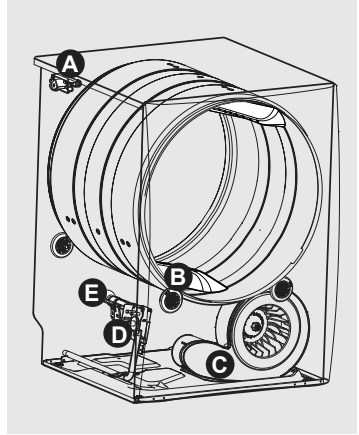

Washer

You may or may not hear the following sounds from the laundry center washer:

- F. **DRAIN HOSE** The washer has a flexible drain hose to carry water from the washer to the stand pipe of your home. You will hear water flowing into your stand pipe. This is a normal part of the operation of the washer.
- G. **WATER VALVES/DISPENSER** As water enters the dispenser system, it is common to hear a water flowing sound. This normal sound will vary slightly based on the water pressure in your home.
- H. **DOOR LOCK** Your washer is equipped with a door lock with an electric solenoid. There will be a clicking sound as the washer door is locked or unlocked.
- I. **DRAIN/RECIRCULATION PUMPS** Your washer is equipped with multiple high velocity system pumps. It is normal to hear humming and gurgling sounds as water is either pumped from the washer during the drain phase or recirculated during the prewash and wash phases. Both of these sounds are normal and indicate that your pump is functioning correctly.
- J. **HIGH SPEED MOTOR** A powerful motor is used to drive the drum to high spin speeds to extract water from your load. You will hear a sound associated with these higher spin speeds. This sound is normal and will vary slightly as the spin speed varies with load size and cycle selected.

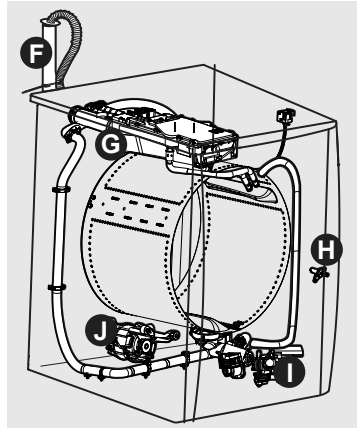

Stain Removal Procedures

To reduce the risk of fire or serious injury to persons or property, comply with the basic warnings listed below:

- Read and comply with all instructions on stain removal products.
- Keep stain removal products in their original labeled containers and out of children's reach.
- Thoroughly wash any utensils used.
- DO NOT combine stain removal products, especially ammonia and chlorine bleach. Dangerous fumes can result.
- Never wash items which have been previously cleaned in, washed in, soaked in or spotted with gasoline, dry cleaning solvents or other flammable or explosive substances because they give off vapors that could ignite or explode.
- Never use highly flammable solvents, such as gasoline, inside the home. Vapors can explode on contact with flames or sparks.

For Successful Stain Removal:

- Remove stains promptly.
- Determine the kind of stain, then follow the recommended treatment in the stain removal chart on the next page.
- To pretreat stains, use a stain treatment product, liquid detergent, or a paste made from powder detergent and water.
- Use cold water on unknown stains as hot water can set stains.
- Consult care label instructions for treatments to avoid on specific fabrics.
- Check for colorfastness by testing stain remover products on an inside seam.
- Rinse and wash items after stain removal.



WARNING

HARMFUL VAPOR HAZARD

DO NOT use or mix liquid chlorine bleach with other household chemicals such as toilet cleaners, rust removers, acids such as vinegar, or products containing ammonia. These mixtures can produce dangerous fumes which can cause serious injury or death.



For best results

Follow the fabric care label instructions on items to be washed.



Stain Removal Suggestions

STAIN	TREATMENT
Adhesive tape, gum, rubber cement	Apply ice. Scrape off excess. Place stain down on paper towels. Saturate with prewash stain remover or nonflammable dry cleaning fluid.
Baby formula, dairy products, egg	Use product containing enzymes to pretreat or soak stains. Soak for 30 minutes or more. Wash.
Beverages (coffee, tea, soda, juice, alcoholic beverages)	Pretreat stain. Wash using cold water and bleach safe for fabric.
Blood	Rinse with cold water. Rub with bar soap. Or, pretreat or soak with product containing enzymes. Wash using bleach safe for fabric.
Candle wax, crayon	Scrape off surface wax. Place stain face down between paper towels. Press with warm iron until wax is absorbed. Replace paper towels frequently. Treat remaining stain with prewash stain remover or nonflammable dry cleaning fluid. Hand wash to remove solvent. Wash using bleach safe for fabric.
Chocolate	Pretreat or soak in warm water using product containing enzymes. Wash using bleach safe for fabric.
Collar or cuff soil, cosmetics	Pretreat with prewash stain remover or rub with bar soap.
Dye transfer on white fabric	Use packaged color remover. Wash using bleach safe for fabric.
Grass	Pretreat or soak in warm water using product containing enzymes. Wash using bleach safe for fabric.
Grease, oil, tar (butter, fats, salad dressing, cooking oils, car grease, motor oils)	Scrape residue from fabric. Pretreat. Wash using hottest water safe for fabric. For heavy stains and tar, apply nonflammable dry cleaning fluid to back of stain. Replace towels under stain frequently. Rinse thoroughly. Wash using hottest water safe for fabric.
Ink	Some inks may be impossible to remove. Washing may set some inks. Use prewash stain remover, denatured alcohol or nonflammable dry cleaning fluid.
Mildew, scorch	Wash with chlorine bleach if safe for fabric or soak in oxygen bleach and hot water before washing. Badly mildewed fabrics may be permanently damaged.
Mud	Brush off dry mud. Pretreat or soak with product containing enzymes.
Mustard, tomato	Pretreat with prewash stain remover. Wash using bleach safe for fabric.
Nail polish	May be impossible to remove. Place stain face down on paper towels. Apply nail polish remover to back of stain. Repeat, replacing paper towels frequently. DO NOT use on acetate fabrics.
Paint, varnish	WATER BASED: Rinse fabric in cool water while stain is wet. Wash. Once paint is dry, it can't be removed. OIL BASED AND VARNISH: Use solvent recommended on label. Rinse thoroughly before washing.
Perspiration	Use prewash stain remover or rub with bar soap. Rinse. Wash using non chlorine bleach in hottest water safe for fabric.
Rust, brown or yellow discoloration	Use rust remover safe for fabric. DO NOT use chlorine bleach because it may intensify discoloration.
Shoe polish	LIQUID: Pretreat with a paste of powder detergent and water. PASTE: Scrape residue from fabric. Pretreat with prewash stain remover or nonflammable dry cleaning fluid. Rinse. Rub detergent into dampened area. Wash using bleach safe for fabric.
Tomato	Pretreat with prewash stain remover. Wash using fabric safe bleach.
Urine, vomit, mucus, feces	Pretreat or soak in product containing enzymes. Wash using bleach safe for fabric.
Wine	Pretreat or soak in cold water. Wash in hottest water and bleach safe for fabric.

Inside Routine Cleaning

To help prevent odors or humidity accumulation leave the door open with the door stand ventilation feature (on select models) for a few hours after use or whenever the washer is not in use.

To Refresh or Clean inside of Laundry Center

To clean and freshen the laundry center washer, run the **clean washer** cycle. Complete the cycle once a month for best results.

NOTE

Every 50 cycles, your laundry center will illuminate the clean cycle indicator to remind you to run a clean washer cycle.

To begin the cycle, select the **clean washer** cycle. Remove the **LIQUID DETERGENT** cup from the dispenser if installed. **REMOVE ALL ITEMS FROM WASH DRUM** before filling the detergent compartment with one (1) cup of liquid chlorine bleach **OR** one (1) pouch of Tide™ Washing Machine Cleaner. **DO NOT** use both. Press **start/pause** to begin.

Tide is a trademark of The Procter & Gamble Company, Cincinnati, Ohio.

IMPORTANT

Items left in laundry center washer while running the **clean washer** cycle will cause a severe out-of-balance situation that could damage the washing machine.

For best results

Immediately follow up with a rinse & spin cycle. Select max spin with no detergent or bleach to help clear any residual bleach left after the clean washer cycle.

To Clean the dispenser drawer

NOTE

Detergent and fabric softener may build up in the dispenser drawer. Residue should be removed once or twice a month.

Cleaning the compartment dispenser (7300 series)

To remove:

1. Pull the drawer out until it stops.
2. Press down firmly on the lock tab in the right rear corner of the dispenser cavity to release the drawer, then pull out the drawer to remove.

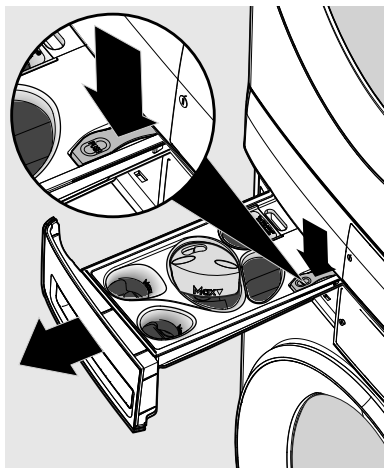

3. Remove all inserts from the drawers.
4. Rinse the drawer and inserts with hot tap water to remove traces of accumulated powders and liquids. Large amounts of fabric softener residue may indicate improper dilution or more frequent cleaning is required.
5. Use a small brush clean the drawer recess and opening. Remove all residue from the upper and lower parts of the recess.

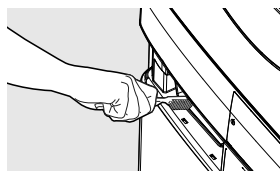

6. Replace the insert by pressing it in place until you hear a slight click.
7. Return the dispenser drawer to the laundry center.

Cleaning the Adaptive Dispenser™ (7600 Series)

1. Pull the dispenser out until it stops.
2. Press down firmly on the lock tab in the right rear corner of the dispenser cavity to release the drawer, then pull out the drawer to remove.
3. Remove the detergent cup and top cover from the dispenser drawer.
4. Remove the bottom cover from the dispenser drawer.
 - a) First, pull the two lock tabs at the rear of the dispenser drawer to unlatch the back cover.
 - b) Then, gently pull back the two clips on the front of the bottom cover to fully release it from the dispenser drawer.

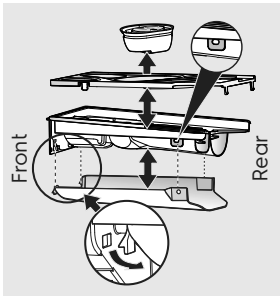

5. Rinse the dispenser drawer, covers, and detergent cup with hot tap water to remove traces of accumulated powders and liquids. Large amounts of fabric softener residue may indicate improper dilution or more frequent cleaning is required.
6. Use a small brush clean the drawer recess and opening. Remove all residue from the upper and lower parts of the recess.
7. Reassemble dispenser drawer and check to ensure that all pieces are securely in place.
8. Return the dispenser drawer to the laundry center.

Aggressive Inside Cleaning

Follow this cleaning procedure if severe odor or residue buildup have developed due to not running the **clean washer** cycle or cleaning the folds in the rubber gasket.

Cleaning Procedure: Washer Drum

Ensure the wash tub is empty. Open the detergent drawer and pour eight cups of bleach into the **Main Wash** detergent compartment. Select **clean washer** cycle as described previously in **Inside Routine Cleaning**.

Upon cycle completion inspect the interior of the washer to see if the odor/residue has been eliminated. Repeat the above procedure if any additional cleaning is required. This may take several cycles depending on the severity of the odor/residue. You may observe some remaining discoloration due to the long term effects of this residue.

Clean especially contaminated areas inside the drum, including the front rubber seal, by scrubbing with a bleach cleaner on a scrub brush, soft sponge, or towel.



IMPORTANT

Always wear rubber or latex gloves and protect floor and clothing from damage.

If odor is still left after bleach cycle(s) and bleach cleaner, open the detergent drawer and pour one (1) pouch of Tide™ Washing Machine Cleaner in detergent drawer. Select clean washer cycle as above and start the washer.



IMPORTANT

See **Inside Routine Cleaning** for future cleaning maintenance which is necessary to avoid repeating issues.

Adaptive Dispenser™ Preventative Cleaning

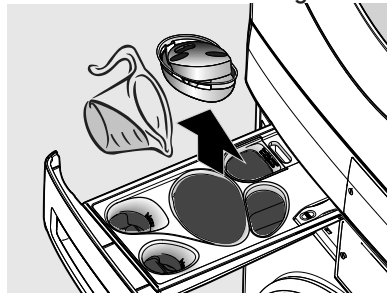

Outside Routine Cleaning

- When cycles have completed, wipe top and sides of washer with a damp cloth.
- Clean the cabinet with mild soap and water. Never use harsh, gritty or abrasive cleansers
- If the cabinet becomes stained, clean with diluted chlorine bleach (1 part bleach to 8 parts water). Rinse several times with clear water.
- Remove glue residue from tape or labels with a mixture of warm water and mild detergent. Or, touch residue with the sticky side of tape.
- Use only a damp cloth when cleaning chrome parts.
- Place a strip of cardboard or thin fiberboard under the front leveling legs before moving the laundry center to prevent damage to the floor.



IMPORTANT

DO NOT store or place laundry products on top of the laundry center at any time. They can damage the finish or controls.



Winterizing Instructions

1. Turn off water supply faucets.
2. Disconnect hoses from water supply and drain water from hoses. Vacuum out each water supply inlet with a waterproof utility vac to ensure water valves are completely drained. Damage will occur if water in water inlet valves are allowed to freeze.
3. Plug electrical cord into a properly grounded electrical outlet.
4. Add 1 gallon (3.8 L) nontoxic recreational vehicle (RV) antifreeze to empty wash drum. Close door.
5. Select any cycle. Press **start/pause** and let the washer drain for 1 minute to drain out all the water. Not all of the RV antifreeze will be expelled.
6. Press **cancel**, unplug electrical power cord, dry off drum interior and close door.
7. Remove dispenser drawer. Drain any water in compartments and dry compartments. Replace drawer.
8. Store laundry center in an upright position.
9. To remove antifreeze from laundry center after storage, run empty washer through a complete cycle with detergent. DO NOT add wash load.



IMPORTANT

If the washer is stored in an area where freezing can occur or moved in freezing temperatures, follow these winterizing instructions to prevent damage to the washer:



Follow WINTERIZING INSTRUCTIONS for cold weather storage and care.



Water Inlet Hose Inspection

Periodically inspect all water inlet hoses for water leaks, wear, cuts, corrosion and bulges. Replace all hoses, if any sign of the above is visible. All hoses should be replaced every 5 years to reduce the risk of hose failures. When replacing hoses, refer to the Installation sections of this Use & Care Manual for proper installation instructions. DO NOT over-tighten or cross thread the fittings. DO NOT allow the hose to rub against sharp objects. Always ensure the hose fitting rubber gasket is installed and free from water leaks when water pressure is applied.

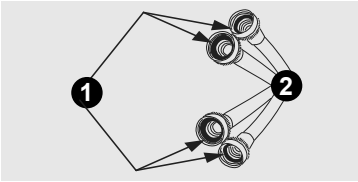

1. Rubber washers must be present
2. Replace hoses every 5 years

Instructions for Limited Use, Vacation and Away from Home



CAUTION

Your laundry center should be operated **ONLY** when you are home. Water leakage is a safety issue and can cause personal injury or property damage. Follow these steps if you are away from home or not using your laundry center for extended periods of time.

1. Turn off the water supply to the laundry center to avoid water leaks due to unforeseen water pressure surges in the water supply.
2. Disconnect or unplug the electrical power to the laundry center.
3. Remove excess water from the dispenser, interior door and tub and perform the Care and Cleaning steps.

Reconnecting Water Supply and Electrical



IMPORTANT

When reinstalling the laundry center after disconnecting the water supply lines and electrical power, please follow the steps below:

1. Review the *Installation* section of this manual to ensure the appliance is level and the water and electrical power supply is properly connected.
2. Ensure the water lines are flushed of debris, prior to connecting the water lines to the washer inlet.
3. Check for water leaks and replace supply hoses if needed.



CAUTION

Damaged or improperly installed water lines can cause the water lines or connections to leak. Water leakage is a safety issue and can cause personal injury or property damage.



WARNING

Improper grounding of the washer may cause serious injury or death. Check with a licensed electrician if you are in doubt as to whether the appliance is properly grounded.



CAUTION

Do not, under any circumstances, cut, remove, or bypass the grounding prong.

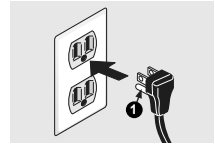

1. Power cord with grounded prong.



WARNING

To reduce risk of fire or serious injury to persons or property, comply with the basic warnings listed in the Important Safety Information and those listed below.

Cleaning the Filter



WARNING

Clean the lint filter after every load. **CLEAN LINT** will be displayed at the end of the cycle to remind you to remove lint from the filter.

Clean the lint filter after every load. Lint build-up on the filter restricts air flow, which causes longer drying times. The filter is located at the bottom of the door opening.

Cleaning the LuxCare™ Lint Shield Filter

1. Remove the filter by pulling it straight up from the dryer opening.

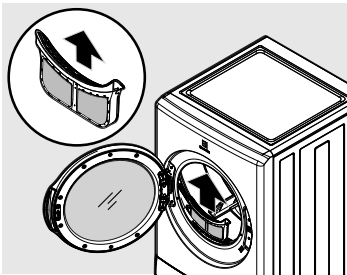

2. Press down the button on the top of the filter to open the clamshell.

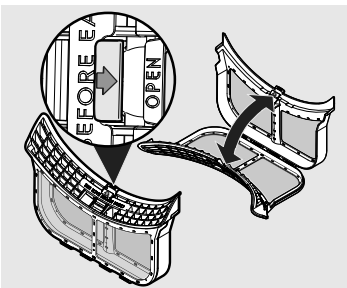

3. Gently clean the lint from the filter.

4. Snap the filter closed and place back into the dryer opening.



IMPORTANT

- DO NOT open the clamshell filter beyond the hinge limit.
- ALWAYS handle the clamshell filter by the frame, not by the mesh material.

Inside

- Occasionally a waxy build-up may form on the lint filter and/or moisture sensing bars from using dryer-added fabric softener sheets. To remove this build-up, wash them with warm, soapy water. Dry the filter thoroughly and replace.
- If the dryer drum becomes stained from non colorfast fabrics, clean with a damp cloth and a mild liquid household cleanser. Remove cleanser residue before drying the next load.
- Before cleaning the dryer drum interior, unplug the electrical power cord to avoid electrical shock hazards.
- DO NOT use any type of spray cleanser when cleaning the dryer interior. Hazardous fumes or electrical shock could occur.
- **Every 18 months a qualified service professional should clean the dryer cabinet interior, lint screen housing and exhaust duct. These areas can collect lint and dust over time. An excessive amount of lint build-up could result in inefficient drying and possible fire hazard.**



WARNING

FIRE HAZARD

A clothes dryer produces combustible lint. The dryer must be connected to an outdoor exhaust. Regularly inspect the outdoor exhaust opening and remove any accumulation of lint around the opening and in the surrounding area.

Common Washing Inquiries

Many washing problems involve poor soil and stain removal, residues of lint and scum, and fabric damage. For satisfactory washing results, follow these suggestions provided by The Soap and Detergent Association.

PROBLEM	POSSIBLE CAUSES	SOLUTIONS
Blue stains	<ul style="list-style-type: none"> • Undiluted liquid detergent or fabric softener dispensed directly onto fabric. 	<ul style="list-style-type: none"> • If caused by detergent, mix 1 cup (240 ml) white vinegar with 1 qt (.95 L) water in plastic container. Soak 1 hour. Rinse. • If caused by fabric softener, rub stains with bar soap. Wash. • Avoid overfilling detergent and fabric softener compartments of dispenser.
Discoloration, graying	<ul style="list-style-type: none"> • Not enough detergent. • Wash water temperature too low. • Incorrect sorting. 	<ul style="list-style-type: none"> • Rewash with correct amount of detergent and hottest water safe for fabric. • Add bleach safe for fabric. • Sort items by soil level and color. • Use correct amount of detergent, hottest water and bleach safe for fabric.
Greasy, oily stains	<ul style="list-style-type: none"> • Not enough detergent. • Undiluted liquid fabric softener poured directly on fabric. 	<ul style="list-style-type: none"> • Treat with prewash stain remover or liquid detergent. • Increase detergent and water temperature. Rewash. • Rub fabric softener stains with bar soap. • Use correct amount of detergent and hottest water safe for fabric. • DO NOT pour liquid fabric softener directly on fabric.
Holes, tears, or snags	<ul style="list-style-type: none"> • Incorrect use of chlorine bleach. • Unfastened zippers, hooks, buckles. • Rips, tears and broken threads. • Overloading washer. • Degradation of fabric. 	<ul style="list-style-type: none"> • May be irreversible if rips, tears and seams cannot be mended. • Never pour chlorine bleach directly on fabric. • Check condition of items before washing.
Lint	<ul style="list-style-type: none"> • Incorrect sorting. • Tissues left in pocket. • Overloading washer. • Not enough detergent. • Undissolved detergent has left a residue resembling lint. • Static cling is attracting lint. • Load washed too long. 	<ul style="list-style-type: none"> • Reduce load size. Rewash using correct water temperature, water level, and amount of detergent. • Add non-precipitating water conditioner to wash water to remove detergent residue. • Add liquid fabric softener to final rinse. • Dry load in dryer. • Remove lint with lint brush or roller. • See <i>Operating Your Washer</i>. • DO NOT overload washer. • Use correct temperature and amount of detergent, water and wash time.

PROBLEM	POSSIBLE CAUSES	SOLUTIONS
Pilling (Fibers ball up and cling to fabric.)	<ul style="list-style-type: none"> • Pilling is normal with synthetic and permanent press fabrics. This is due to abrasion from normal wear. 	<ul style="list-style-type: none"> • Use a lint brush or shaver to remove pills. • Use fabric softener in washer to lubricate fibers. • When ironing, use spray starch or fabric finish on collars and cuffs. • Turn items inside out to reduce abrasion.
Residue or powder on dark items; Stiff, harsh fabrics.	<ul style="list-style-type: none"> • Undissolved detergent. • Some granular detergents can combine with hard water minerals to form a residue. • Overloading washer. 	<ul style="list-style-type: none"> • Rewash load. • Increase water temperature using hottest water safe for fabric. • DO NOT overload washer. • Use liquid detergent or non-precipitating water conditioner with powder detergent
Wrinkling	<ul style="list-style-type: none"> • Overloading washer. • Incorrect wash cycle for wash load. 	<ul style="list-style-type: none"> • Reduce load size. • Rinse in cold water with liquid fabric softener using the casual or delicate cycle. • DO NOT overload washer. • Remove items from washer as soon as cycle is completed. • Use liquid fabric softener.
Yellow buildup of body soil on synthetic fabrics	<ul style="list-style-type: none"> • Agitation time too short • Wash water temperature too low. • Not enough detergent 	<ul style="list-style-type: none"> • Soak in detergent booster or product containing enzymes. • Wash in hottest water safe for fabric using casual cycle. • Increase detergent • Add bleach safe for fabric or treat with color remover. • Select correct cycle. • Use correct amount of detergent • Wash synthetics frequently using hot or warm water.
Yellow or brown rust stains	<ul style="list-style-type: none"> • Iron or manganese in water supply, water pipes, or water heater. 	<ul style="list-style-type: none"> • To restore discolored load of whites, use rust remover safe for fabric. • DO NOT use chlorine bleach to remove rust stains. It may intensify discoloration. • Use non-precipitating water softener. • Before washing, run hot water for a few minutes to clear lines. • Drain water heater occasionally. • For an ongoing problem, install an iron filter in your water supply system.

PROBLEM	POSSIBLE CAUSES	SOLUTIONS
Residue stain buildup in gasket	<ul style="list-style-type: none"> • Moisture in washer. • Use of non-HE detergent • Overdosing detergent • Overloading wash drum. • Leaving a wet load set in washer. • Cold water washes which may not completely dissolve and remove detergents. 	<ul style="list-style-type: none"> • Perform clean washer cycle • Scrub gasket with Comet™ Spray Gel Mildew Stain Remover - use brush to remove stains. • Use only HE (high efficiency detergent) along with recommended dosage. • Remove wash load immediately upon cycle completion. • Run dehumidifier in laundry room. • Avoid overfilling detergent and fabric softener compartments of dispenser. • Dry the inside of washer and gasket after every run.
Residue stain buildup in dispenser drawer or detergent pack not dissolved.	<ul style="list-style-type: none"> • Moisture in the washer. • Use of non-HE detergent • Overdosing detergent • Adding more than two detergent packs to detergent pack compartment • PODS® option not selected when using detergent pack (on select models). 	<ul style="list-style-type: none"> • Remove and clean dispenser and inserts with combination of ¾ cup liquid chlorine bleach and one gallon hot water. Rinse well, and repeat if necessary. NOTE: Wear rubber of latex gloves. Protect floor and clothing from bleach damage. • Use only HE (high efficiency detergent) along with recommended dosage. • Avoid overfilling detergent and fabric softener compartments of dispenser. • Check that PODS® option is selected and detergent pack is placed in PODS® dispenser compartment when using detergent pack (on select models).
Water in fold of flexible gasket	<ul style="list-style-type: none"> • Result of washing and part of normal operation. 	<ul style="list-style-type: none"> • At the end of each wash, dry inside of gasket fold with clean dry towel all around gasket
Odor	<ul style="list-style-type: none"> • Moisture in the washer. • Use of non-HE detergent • Overdosing detergent • Leaving a wet load remain in washer. • Cold water washes which may not completely dissolve and remove detergents. 	<ul style="list-style-type: none"> • Perform clean washer cycle. • At the end of each wash, dry inside of gasket fold with clean, dry towel all around gasket • Use only HE (high efficiency detergent) along with recommended dosage. • Remove wash load immediately upon cycle completion. • Pour one cup liquid chlorine bleach in standpipe; let remain a day and flush with water. • Utilize the door stand ventilation feature for a few hours after use or whenever washer is not in use.

Before Calling

Before calling for service, review this list. It may save both time and expense. The list includes common occurrences that are not the result of defective workmanship or materials in this washer.

PROBLEM	POSSIBLE CAUSES	SOLUTIONS
NOISE (Please refer to <i>Normal Operating Sounds</i>)		
High pitch "jet engine" noise	<ul style="list-style-type: none"> A certain amount of motor whine is normal during the spin cycle. 	
Rattling and clanking noise	<ul style="list-style-type: none"> Foreign objects such as coins or safety pins may be in drum or pump. Belt buckles and metal fasteners are hitting wash drum. 	<ul style="list-style-type: none"> Stop washer and check drum. If no objects are found, perform cycle with empty drum. If noise continues, item may be in pump. Call your authorized service technician. To prevent unnecessary noise and damage to drum, fasten fasteners and turn items inside out.
Thumping sound	<ul style="list-style-type: none"> Heavy wash loads may produce a thumping sound. This is usually normal. If sound continues, washer is probably out of balance. 	<ul style="list-style-type: none"> Stop washer and redistribute wash load.
Vibrating noise	<ul style="list-style-type: none"> Washer is not resting firmly on floor. Shipping bolts and foam block have not been removed during installation. Wash load unevenly distributed in drum. 	<ul style="list-style-type: none"> Move washer so it rests firmly on floor. Adjust leveling legs. See <i>Leveling the washer</i> for details. See Installation sections of this manual for removing shipping bolts and foam block. Stop washer and rearrange wash load.
OPERATING		
Residue left in drum	<ul style="list-style-type: none"> Heavily soiled items. 	<ul style="list-style-type: none"> Wipe drum with a nonabrasive household cleanser, then rinse. Shake or brush excess dirt and sand from items before washing.
LED displays "dr"	<ul style="list-style-type: none"> Washer has been programmed to temporarily perform a repeating demo cycle. 	<ul style="list-style-type: none"> Reset the unit back to factory default settings. <ol style="list-style-type: none"> Press power to turn off unit. Press power again to turn unit on. Look for console to light up. Wait at least 10 seconds, then simultaneously press and hold soil and options buttons for 3 secs. Lights will turn OFF and ON, indicating the unit has been reset to factory default
Washer won't spin	<ul style="list-style-type: none"> Load is too small. 	<ul style="list-style-type: none"> Add 1 or 2 similar items to help balance the load.
LED Displays "CLEAR door"	<ul style="list-style-type: none"> Washer has detected something trapped between the door and door gasket 	<ul style="list-style-type: none"> Press the cancel button to unlock the door, remove the trapped item, close the door and restart the cycle.

PROBLEM	POSSIBLE CAUSES	SOLUTIONS
Washer does not start	<ul style="list-style-type: none"> • Electrical power cord may not be plugged in or connection may be loose. • House fuse blown, circuit breaker tripped, or a power outage has occurred. • Action of pressing start/pause button on "touch screen" style console not recognized. • Water supply faucets are not turned on. • Motor is overheated. Washer motor will stop if overheated. • Door may be open. Unit will not operate with door open. • Light next to start/pause button is flashing indicating unit is paused. 	<ul style="list-style-type: none"> • Make sure plug fits tightly in wall outlet. • Reset circuit breaker or replace fuse. DO NOT increase fuse capacity. If problem is a circuit overload, have it corrected by a qualified electrician. If problem is a power outage, call local electric company. • Press start/pause button with bare fingertip. • Turn on water supply faucets. • It will automatically restart after a cool down period of up to 30 minutes (if washer has not been manually turned off). • Ensure door is closed. • Press start/pause button to continue the cycle.
WATER		
Water collects in folds of the door gasket at the end of the cycle	<ul style="list-style-type: none"> • This is a result of the washing action and is part of the normal operation of the washer. 	<ul style="list-style-type: none"> • Wipe and dry the gasket to remove water and any debris remaining in the gasket after use.
Water collects in bleach and fabric softener compartments	<ul style="list-style-type: none"> • This is a result of the siphoning action and is part of the normal operation of the washer. 	<ul style="list-style-type: none"> • Water may be removed by removing the dispenser drawer (see <i>Care and Cleaning</i> in this manual) and draining water into the empty drum or sink.
Wash load too wet after spin	<ul style="list-style-type: none"> • Washer is overloaded. • Load is too small. • Load is out of balance. • Drain hose is kinked. 	<ul style="list-style-type: none"> • DO NOT overload washer. See <i>Operating Your Washer</i>. • Add 1 or 2 similar items to help balance load. • Rearrange load to allow proper spinning. • Straighten drain hose.
Water does not enter washer or it enters slowly	<ul style="list-style-type: none"> • Water supply is not adequate in area. • Water supply faucets are not completely open. • Water is being used elsewhere in the house. Water pressure must be at least 30 psi (260 kPa). • Water inlet hoses are kinked. • Water inlet screens plugged. 	<ul style="list-style-type: none"> • Check another faucet in the house. Wait until water supply and pressure increase. • Fully open hot and cold faucets. • Avoid running water elsewhere while washer is filling. • Straighten hoses. • Remove hose from inlets and clean screens.

PROBLEM	POSSIBLE CAUSES	SOLUTIONS
Warm or hot water is not hot enough	<ul style="list-style-type: none"> Hot water heater is set too low or is a distance from washer. Hot water is being used elsewhere in the house. 	<ul style="list-style-type: none"> Measure hot water temperature at nearby faucet with candy or meat thermometer. Water temperature should be at least 120°F (49°C). Adjust water heater as necessary. Avoid using hot water elsewhere before or during washer use. There may not be enough hot water available for proper cleaning. If problem persists, your hot water system may be unable to support more than 1 use at a time.
Water in washer does not drain or drains slowly	<ul style="list-style-type: none"> Drain hose is kinked or clogged. Drain hose standpipe is too tall. Maximum standpipe height is 8' (2.4 m). House drain pipes are clogged. 	<ul style="list-style-type: none"> Clean and straighten the drain hose. Reduce standpipe height to less than 8' (2.4 m). See Installation sections of this manual. Unclog drain pipes. Contact plumber if necessary.
Water leaks	<ul style="list-style-type: none"> Fill hose connection is loose at faucet or washer. Dispenser drawer not completely closed Water hoses have damage, cuts or corrosion. 	<ul style="list-style-type: none"> Check and tighten hose connections. Install rubber sealing washers provided. Close dispenser drawer completely. Replace hoses.
Over-sudsing	<ul style="list-style-type: none"> HE detergent is not being used. Too much detergent 	<ul style="list-style-type: none"> Run rinse cycle. Use a low-sudsing, high efficiency detergent. Run rinse cycle. Use less detergent in future loads.
Incorrect wash and rinse temperatures. The LED display will alert this condition with "HOSE" alarm	<ul style="list-style-type: none"> Hot and cold water hoses are connected to wrong supply faucets. 	<ul style="list-style-type: none"> Connect hot water hose to hot water faucet and cold water hose to cold water faucet
Water is entering washer but tub does not fill	<ul style="list-style-type: none"> Drain hose standpipe is too low. Standpipe must be a min of 23.6" (60 cm) high to prevent siphoning. 	<ul style="list-style-type: none"> Increase standpipe height to at least 23.6" (60 cm). See Installation sections of this manual.

Common Drying Inquiries

Many drying problems involve poor cleaning results, poor soil and stain removal, residues of lint and scum, and fabric damage. For satisfactory drying results, follow these suggestions provided by The Soap and Detergent Association.

PROBLEM	POSSIBLE CAUSES	SOLUTIONS
Greasy, oily stains	<ul style="list-style-type: none"> Fabric softener sheet 	<ul style="list-style-type: none"> Rub fabric softener stains with bar soap. Rinse and rewash. Add a few bath towels to small loads for proper tumbling. Some "silk-like" fabrics should be air dried. Use proper drying temperature. Place fabric softener sheet on top of load before starting the dryer.
Lint	<ul style="list-style-type: none"> Overloading Over-drying causes static electricity Lint screen not clean when cycle began Lint is attached to "pills" 	<ul style="list-style-type: none"> Reduce load size and rewash using liquid fabric softener in the final rinse. Or, add a fabric softener sheet and tumble without heat. Use lint brush or roller to remove lint. DO NOT overload dryer. Use fabric softener in washer or dryer to reduce static electricity. Remove items when they are slightly damp to avoid over-drying. Check that lint filter is clean and in place.
Pilling (fibers break off, ball up and cling to fabric)	<ul style="list-style-type: none"> Over-drying 	<ul style="list-style-type: none"> Use a lint brush or shaver to remove pills. Use fabric softener to lubricate fibers. When ironing, use spray starch or fabric finish on collars and cuffs. Turn items inside out to reduce abrasion.
Shrinking	<ul style="list-style-type: none"> Temperature too high Over-drying 	<ul style="list-style-type: none"> Irreversible condition. Follow fabric care label directions. If shrinking is a concern, check load often. Remove items while slightly damp and hang or lay flat to complete drying. Block knits into shape.
Wrinkling	<ul style="list-style-type: none"> Overloading Leaving items in dryer after cycle ends 	<ul style="list-style-type: none"> Reduce load size and tumble at medium or low heat for 5-10 minutes. Remove items immediately. Hang or fold. DO NOT overload dryer. Remove items as soon as cycle ends.
Isolated wet spots on fabrics after completed Steam cycle	<ul style="list-style-type: none"> Low water pressure in home is not sufficient to atomize incoming water during steam cycle 	<ul style="list-style-type: none"> Check water line pressure. Ensure water line pressure is minimum of 20 psi. DO NOT exceed 120 psi.

Before Calling

Before calling for service, review this list. It may save both time and expense. The list includes common occurrences that are not the result of defective workmanship or materials in this dryer.

PROBLEM	POSSIBLE CAUSES	SOLUTIONS
Dryer does not start.	<ul style="list-style-type: none"> Electrical power cord is not securely plugged in or plug may be loose. House fuse blown or circuit breaker tripped. Action of pressing start button on "touch screen" style console not recognized. Thermal limiter tripped. Delay time inadvertently activated. Door may be open. Unit will not operate with door open. Difficult load to dry. 	<ul style="list-style-type: none"> Make sure the plug fits tightly in wall outlet. Reset circuit breaker or replace fuse. Make sure electrical line is not overloaded and the dryer is on a separate circuit. Press start button with bare fingertip. Call authorized service person for replacement. Ensure delay time not activated. Ensure door is closed. Select Dry Boost option
LED displays "dn".	<ul style="list-style-type: none"> Dryer has been programmed to temporarily perform a repeating demo cycle. 	<ul style="list-style-type: none"> Reset the unit back to factory default settings as described earlier.
Dryer runs but won't heat.	<ul style="list-style-type: none"> There are 2 house fuses in the dryer circuit. If 1 of the 2 fuses is blown, the drum may turn but the heater will not operate (electric models). Gas supply valve is not open (gas models). Dryer does not have enough air supply to support the burner flame (gas models). LP gas supply tank is empty or there has been a utility interruption of natural gas (gas models). 	<ul style="list-style-type: none"> Replace fuse. Check to make sure supply valve is open. Refer to the <i>installation instructions</i> provided with the dryer. See the <i>Installation sections of this manual</i>. Refill or replace tank. Dryer should heat when utility service is restored.

76

TROUBLESHOOTING

PROBLEM	POSSIBLE CAUSES	SOLUTIONS
Drying cycle takes too long, outside of the dryer feels too hot or smells hot.	<ul style="list-style-type: none"> Lint filter is clogged with lint. Exhaust duct requirements have not been met. Electric dryer is connected to a 208 volt circuit. Drying procedures have not been followed. Outside exhaust hood or exhaust duct may be clogged or restricted. High humidity. 	<ul style="list-style-type: none"> Make sure all lint has been removed from the dryer lint filter before starting each cycle. Exhaust duct must be at least 4 inches in diameter and made of rigid or semi-rigid metal. When in place, the duct must not exceed length listed in the <i>installation instructions</i>. Drying time will be 20% longer than drying on a 240 volt circuit. See <i>Operating Instructions</i>. Clean out any obstruction. Use a dehumidifier near the dryer.
Excess moisture in drum between cycles.	<ul style="list-style-type: none"> Exhaust damper stuck open or not present. 	<ul style="list-style-type: none"> Fix or clean the damper, or install new one.
Excessive wrinkling.	<ul style="list-style-type: none"> Dryer is overloaded. Items left in dryer too long. Insufficient sorting of items. Drying temperature too high. Drying load is very small. 	<ul style="list-style-type: none"> DO NOT overload. See <i>Operating Instructions</i>. Remove items as soon as cycle ends. See <i>Operating Instructions</i>. Follow fabric care label instructions. Add two or three larger items.
Scratching or chipping of the drum finish.	<ul style="list-style-type: none"> Foreign objects such as coins, pins, clips or buttons are inside the dryer.* Permanently attached items such as belt buckles, zippers and fasteners may be hitting the inside of the drum.* 	<ul style="list-style-type: none"> Always remove foreign objects from pockets before laundering. Remove objects from drum and restart dryer. It may be necessary to sew a scrap of material securely around ornaments before drying to prevent scratching and damage to the dryer.
* Drum damage caused by foreign objects or permanently attached items is not covered by the warranty.		

For the applicable warranty period as set forth below, as measured from your original date of purchase, Electrolux will repair or replace any parts of this appliance that prove to be defective in materials or workmanship when such appliance is installed, used and maintained in accordance with the provided instructions.

Warranty Periods:

- All parts — One year including labor. In addition, your appliance is covered by a one year, parts only, limited warranty. During the 2nd year from your original date of purchase, Electrolux will pay for parts needed for this appliance that have proven to be defective in materials or workmanship when your appliance is installed, used, and maintained in accordance with the provided instructions.

Exclusions

This warranty does not cover the following:

1. Products with original serial numbers that have been removed, altered or cannot be readily determined.
2. Product that has been transferred from its original owner to another party or removed outside the USA or Canada.
3. Rust on the interior or exterior of the unit
4. Products purchased "as-is" are not covered by this warranty.
5. Products used in a commercial setting.
6. Service calls which DO NOT involve malfunction or defects in materials or workmanship, or for appliances not in ordinary household use or used other than in accordance with the provided instructions.
7. Service calls to correct the installation of your appliance or to instruct you how to use your appliance.
8. Expenses for making the appliance accessible for servicing, such as removal of trim, cupboards, shelves, etc., which are not a part of the appliance when it is shipped from the factory.
9. Service calls to repair or replace appliance light bulbs, air filters, water filters, other consumables, or knobs, handles, or other cosmetic parts.
10. Pickup and delivery costs; your appliance is designed to be repaired in the home.
11. Surcharges including, but not limited to, any after hour, weekend, or holiday service calls, tolls, ferry trip charges, or mileage expense for service calls to remote areas, including the state of Alaska.
12. Damages to the finish of appliance or home incurred during transportation or installation, including but not limited to floors, cabinets, walls, etc.
13. Damages caused by: services performed by unauthorized service companies; use of parts other than genuine Electrolux parts or parts obtained from persons other than authorized service companies; or external causes such as abuse, misuse, inadequate power supply, accidents, fires, or acts of God.

DISCLAIMER OF IMPLIED WARRANTIES; LIMITATION OF REMEDIES

CUSTOMER'S SOLE AND EXCLUSIVE REMEDY UNDER THIS LIMITED WARRANTY SHALL BE REPAIR OR REPLACEMENT AS PROVIDED HEREIN. **CLAIMS BASED ON IMPLIED WARRANTIES, INCLUDING WARRANTIES OF MERCHANTABILITY OR FITNESS FOR A PARTICULAR PURPOSE, ARE LIMITED TO ONE YEAR OR THE SHORTEST PERIOD ALLOWED BY LAW, BUT NOT LESS THAN ONE YEAR.** ELECTROLUX SHALL NOT BE LIABLE FOR CONSEQUENTIAL OR INCIDENTAL DAMAGES SUCH AS PROPERTY DAMAGE AND INCIDENTAL EXPENSES RESULTING FROM ANY BREACH OF THIS WRITTEN LIMITED WARRANTY OR ANY IMPLIED WARRANTY. SOME STATES AND PROVINCES DO NOT ALLOW THE EXCLUSION OR LIMITATION OF INCIDENTAL OR CONSEQUENTIAL DAMAGES, OR LIMITATIONS ON THE DURATION OF IMPLIED WARRANTIES, SO THESE LIMITATIONS OR EXCLUSIONS MAY NOT APPLY TO YOU. THIS WRITTEN WARRANTY GIVES YOU SPECIFIC LEGAL RIGHTS. YOU MAY ALSO HAVE OTHER RIGHTS THAT VARY FROM STATE TO STATE.

If You Need Service

Keep your receipt, delivery slip, or some other appropriate payment record to establish the warranty period should service be required. If service is performed, it is in your best interest to obtain and keep all receipts. Service under this warranty must be obtained by contacting Electrolux at the addresses or phone numbers below.

This warranty only applies in the USA, Puerto Rico and Canada. In the USA and Puerto Rico, your appliance is warranted by Electrolux Major Appliances North America, a division of Electrolux Home Products, Inc. In Canada, your appliance is warranted by Electrolux Canada Corp. Electrolux authorizes no person to change or add to any obligations under this warranty. Obligations for service and parts under this warranty must be performed by Electrolux or an authorized service company. Product features or specifications as described or illustrated are subject to change without notice.

USA**1-877-435-3287**

Electrolux Home Products, Inc.,
North America
10200 David Taylor Drive
Charlotte, NC 28262

**Electrolux****Canada****1-800-265-8352**

Electrolux Canada Corp.
5855 Terry Fox Way
Mississauga, Ontario, Canada
L5V 3E4

CE

A23623504 (July 2024)