



Use & Care Manual

Induction Range

EN 2

Guide d'utilisation et d'entretien

Cuisinière à induction

FR 52

Manual de uso y cuidado

Estufa de inducción

SP 102



2

WELCOME TO ELECTROLUX!

THANK YOU FOR CHOOSING OUR APPLIANCE!

For Customer Care support and webshop visit or download an extended version of this manual, visit:
www.ElectroluxAppliances.com

WELCOME TO ELECTROLUX!.....	2	USING THE COOKTOP.....	16
IMPORTANT SAFETY INSTRUCTIONS.....	3	USING THE OVEN.....	21
FEATURES	9	CARE AND CLEANING.....	40
BEFORE USING THE APPLIANCE.....	13	BEFORE YOU CALL.....	48

This manual is your resource for the use and care of your product. Please read it before using your appliance. Keep it handy for quick reference. If something doesn't seem right, the troubleshooting section will help you with common issues.

FAQs, helpful tips and videos, cleaning products, and kitchen and home accessories are available at www.ElectroluxAppliances.com.

We are here for you! Visit our website, chat with an agent, or call us if you need help. We may be able to help you avoid a service visit. If you need service, we can get that started for you.

Let's make it official! Be sure to register your product.

Keep your product info here so it's easy to find.

Model Number:

Serial Number:

Purchase Date:

Read all instructions before using this appliance.

This manual contains important safety symbols and instructions. Please pay attention to these symbols and follow all instructions given.

Do not attempt to install or operate your appliance until you have read the safety precautions in this manual. Safety items throughout this manual are labeled with a WARNING or CAUTION statement based on the risk type.

Warnings and important instructions appearing in this guide are not meant to cover all possible conditions and situations that may occur. Common sense, caution, and care must be exercised with installing, maintaining, or operating your appliance.

DEFINITIONS

 This is the safety alert symbol. It is used to alert you to potential personal injury hazards. Follow all the safety messages that follow this symbol to avoid possible injury or death.

WARNING

Indicates a potentially hazardous situation which, if not avoided, may result in death or serious injury.

CAUTION

Indicates a potentially hazardous situation which, if not avoided, may result in minor or moderate injury.

IMPORTANT

Indicates installation, operation, maintenance, or valuable information that is not hazard related.

NOTE

Indicates a short, informal reference – something written down to assist the memory or for future reference.

IMPORTANT INSTRUCTIONS FOR UNPACKING AND INSTALLATION

IMPORTANT

Read and follow the instructions and precautions below for unpacking, installing, and servicing your appliance.

Remove all tape and packaging before using the appliance. Dispose of the carton and plastic bags after unpacking the appliance. Never allow children to play with packaging material. Do not remove the wiring label and other information attached to the appliance. Do not remove model/serial number plate.

Cold temperatures can damage the electronic control. If this appliance has not been used for a long time, make sure that it has been stored at temperatures above 32°F (0°C) for at least 3 hours before turning on power to the appliance.

Never modify or alter the construction of the appliance by removing the leveling legs, panels, wire covers, anti-tip brackets/screws, or any other part of the appliance. Be sure to have an appropriate foam-type fire extinguisher available, clearly visible and easily accessible located near the appliance.

All materials used in construction of cabinets, enclosures, and supports surrounding the product must have a temperature rating above 200°F (94°C).

4 IMPORTANT SAFETY INSTRUCTIONS

GROUNDING INSTRUCTIONS

WARNING

- Avoid fire hazard or electrical shock. Failure to follow this warning may cause fire, serious injury, or death.
- Avoid fire hazard or electrical shock. Do not use an adapter plug, an extension cord, or remove the grounding prong from the power plug. Failure to follow this warning may cause fire, serious injury, or death.

Proper Installation—Be sure your appliance is properly installed and grounded by a qualified technician. In the United States, install in accordance with the National Fuel Gas Code ANSI Z223.1/NPFA No. 54, latest edition and National Electrical Code NFPA No. 70 latest edition, and local electrical code requirements. In Canada, install in accordance with CAN/CGA B149.1 and CAN/CGA B149.2 and CSA Standard C22.1, Canadian Electrical code, Part 1—latest editions and local electrical code requirements. Install only as per the installation instructions provided in the documentation received with this appliance.

For personal safety, this appliance must be properly grounded. For maximum safety, the power cord must be securely connected to an electrical outlet or junction box that is the correct voltage, is correctly polarized and properly grounded, and protected by a circuit breaker in accordance with local codes.

It is the personal responsibility of the consumer to have the appropriate outlet or junction box with the correct, properly grounded wall receptacle installed by a qualified electrician. It is the responsibility and obligation of the consumer to contact a qualified installer to ensure that the electrical installation is suitable and in conformance with all local codes and ordinances.

See the installation instructions provided with this appliance for complete installation and grounding instructions.

IMPORTANT INSTRUCTIONS FOR USING THE APPLIANCE

CAUTION

Persons with a pacemaker or similar medical device should exercise caution using or standing near an induction unit while it is in operation as the electromagnetic field may affect the working of the pacemaker or similar medical device. It would be advisable to consult your doctor or the pacemaker or similar medical device manufacturer about your particular situation.

Do not touch surface burners or elements, areas near these burners or elements, interior surfaces of the oven, or the warmer drawer (if provided). Surface burners and elements may be hot even though they appear to be cool. Areas near surface burners and elements may become hot enough to cause burns. During and after use, do not touch, or let clothing or other flammable materials come into contact with these areas until they are cool. These areas may include the cooktop, surfaces facing the cooktop, oven vent areas and the oven door and oven window.

WARNING

- Storage In or On the Appliance - Flammable materials should not be stored in the oven, near surface burners or elements, or in the storage or warmer drawer (if provided). This includes paper, plastic, and cloth items, such as cookbooks, plasticware and towels, as well as flammable liquids. Do not store explosives, such as aerosol cans, on or near the appliance.

! WARNING

- Do not leave children alone - Children should not be left alone or unattended in the area where appliance is in use. They should never be allowed to sit or stand on any part of the appliance, including the storage drawer, lower broiler drawer, warmer drawer, or lower double oven.
- Do not store items of interest to children in the cabinets above the appliance or on the backguards of ranges. Children climbing on or near the appliance to reach items could be seriously injured.
- Do not allow children to climb or play around the appliance. The weight of a child on an open oven door may cause the appliance to tip, resulting in serious burns or other injury. An open drawer when hot may cause burns.
- Stepping, leaning, or sitting on the door or drawers of this appliance can result in serious injuries and also cause damage to the appliance.
- Never cover any slots, holes or passages in the oven bottom or cover and entire rack with materials such as aluminum foil. Aluminum foil linings may also trap heat, causing a fire hazard.

! CAUTION

- When heating fat or grease, watch it closely. Grease may catch fire if it becomes too hot.
- Do not use water or flour on grease fires.
- Smother fire or flame or use dry chemical or foam-type extinguisher. Cover the fire with a pan lid or use baking soda.

! CAUTION

- Only use dry potholders. Moist or damp potholders on hot surfaces may result in burns from steam. Do not let potholders touch hot heating elements or hot cooking areas. Do not use towels or other bulky cloths.
- Do not heat unopened food containers - Build-up of pressure may cause the container to burst and result in injury.
- Wear proper apparel - Loose-fitting or hanging garments should never be worn while using the appliance. Do not let clothing or other flammable materials come into contact with hot surfaces.
- Do not attempt to operate the appliance during a power failure. If the power fails, always turn off the appliance. If the appliance is not turned off, electric surface elements may resume operation when power is restored. Once the power is restored, reset the clock and the oven function.

IMPORTANT INSTRUCTIONS FOR USING YOUR INDUCTION COOKTOP

Know which knob or key controls each surface heating area. Place the cookware containing food on the cooking area before turning it on. Turn the cooking area off before removing the cookware.

Cookware handles should be turned inward and not extend over adjacent surface elements. — To reduce the risk of burns, ignition of flammable materials and spillage due to unintentional contact with the utensil, the handle of the cookware should be positioned so that it is turned inward and does not extend over other cooking areas.

6

IMPORTANT SAFETY INSTRUCTIONS

Use proper pan size – This appliance is equipped with one or more surface units of different sizes. Select cookware with flat bottoms that match the surface unit size. Using the proper cookware on the cooking area will improve efficiency.

Glazed cooking utensils – Only certain types of cookware are suitable for cooktop service and must be magnetic in order to work properly on the induction zones. Check the manufacturer's recommendations for cooktop use to ensure that the cookware is compatible with induction cooking.

Improper cookware may break due to sudden changes in temperature. Check the cookware manufacturer's recommendations for cooktop use.

Do not place metallic objects such as knives, forks, spoons and lids on the cooktop surface since they can become hot.

Never leave surface elements unattended. Boil-overs may cause smoking and greasy spills that may ignite. A pan that has boiled dry could be damaged and may damage the cooktop.

When you are flaming foods under a ventilating hood, turn on the fan.

IMPORTANT INSTRUCTIONS FOR GLASS AND CERAMIC COOKTOPS

WARNING

Do Not Clean or Operate a Broken Cooktop. If cooktop should break, cleaning solutions and spillovers may penetrate the broken cooktop and create a risk of electric shock. Contact a qualified technician immediately.

Clean cooktop glass with caution. If a wet sponge or cloth is used to wipe spills on a hot cooking area, be careful to avoid steam burns. Some cleaners can produce harmful fumes if applied to a hot surface. Avoid scratching the cooktop glass with sharp objects.

IMPORTANT INSTRUCTIONS FOR USING YOUR OVEN

Protective liners—Do not use aluminum foil, aftermarket oven liners, or any other materials or devices to line oven bottom, oven racks, or any other part of the appliance. Only use aluminum as recommended for baking, such as lining cookware or as a cover placed on food. Any other use of protective liners or aluminum foil may result in a risk of electric shock, fire or a short circuit.

Take care when opening oven door, lower oven door, or warmer drawer (some models). Stand to the side of the appliance when opening the door of a hot oven. Let hot air or steam escape before you remove food or place it back in the oven.

Keep oven vent ducts unobstructed. Touching surfaces in this area when the oven is on may cause severe burns. Do not place plastic or heat-sensitive items on or near the oven vent. These items can melt or ignite.

Placement of oven racks - Always place oven racks in required position while the oven is cool. If a rack has to be moved while the oven is hot, do not let the potholder come into contact with a hot burner or element in oven. Use potholders and grasp the rack with both hands when repositioning it. Remove all cookware and utensils before moving the rack.

Do not use a broiler pan without its insert.

Broiler pans and inserts allow dripping fat to drain away from the high heat of the broiler. Do not cover the broiler insert with aluminum foil; exposed fat and grease could ignite.

Do not cook food on the oven bottom.

Always cook in proper cookware and always use the oven racks.

IMPORTANT INSTRUCTIONS FOR CLEANING YOUR APPLIANCE

CAUTION

Make sure all controls are turned off and that the appliance is cool before manually cleaning any part of the appliance. Cleaning a hot appliance can cause burns.

Clean the appliance regularly to keep all parts free of grease that could catch fire. Do not allow grease to accumulate. Greasy deposits in the fan could catch fire.

Always follow the manufacturer's recommended directions when using kitchen cleaners and aerosols. Be aware that excess residue from cleaners and aerosols may ignite causing damage and injury.

Clean ventilating hoods frequently, grease should not be allowed to accumulate on hood or filter. Follow the manufacturer's instructions for cleaning ventilating hoods.

IMPORTANT INSTRUCTIONS FOR SERVICE AND MAINTENANCE

Do not repair or replace any part of the appliance unless specifically recommended in the manuals. All other servicing should be done only by a qualified technician. This reduces the risk of personal injury and damage to the appliance.

Always contact your dealer, distributor, service agent, or manufacturer about problems or conditions you do not understand.

Ask your dealer to recommend a qualified technician and an authorized repair service. Know how to disconnect the power to the appliance at the circuit breaker or fuse box in case of an emergency.

Remove the oven door from any unused oven if it is to be stored or discarded.

Do not touch a hot oven light bulb with a damp cloth. Doing so could cause the bulb to break. Handle halogen lights (if provided) with paper towels or soft gloves.

Disconnect the appliance or shut off the power to the appliance before removing and replacing the bulb.

WARNING

California Residents: for cancer and reproductive harm information, visit www.P65Warnings.ca.gov

8

IMPORTANT SAFETY INSTRUCTIONS

Important: This appliance has been tested and found to comply with the limits for a class B digital device, pursuant to Part 18 of the FCC rules (United States) and ICES-001 (Canada). These limits are designed to provide reasonable protection against harmful interference in a residential installation. This unit uses and can radiate radio frequency energy that may interfere with radio communications if not installed and used in accordance with the instructions manual. However, there is no guarantee that interference will not occur in a particular installation. If this unit does cause interference to radio or television reception, which can be determined by turning the unit off and on, the user is encouraged to try to correct the interference by one or more of the following measures:

- Reorient or relocate the receiving antenna.
- Increase distance between unit and receiver.
- Connect the unit into an outlet or a circuit different from the one to which the receiver is connected.

General description

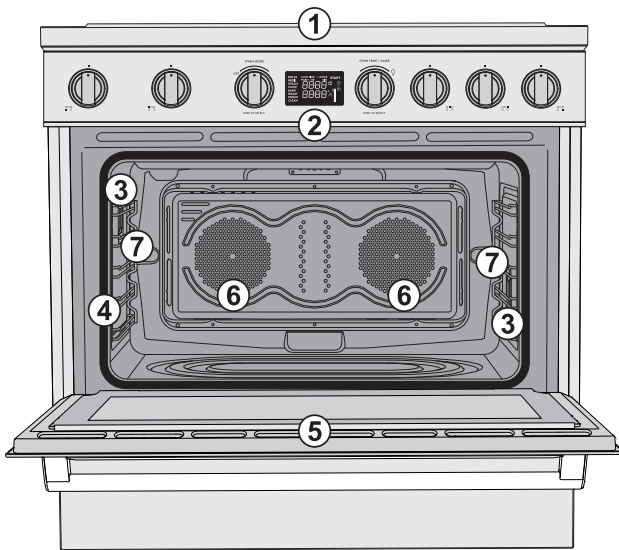

- 1. Cooktop
- 2. Control panel
- 3. Inside lights
- 4. Seal
- 5. Oven door
- 6. Fan
- 7. Rack/tray support frame shelf

Cooktop

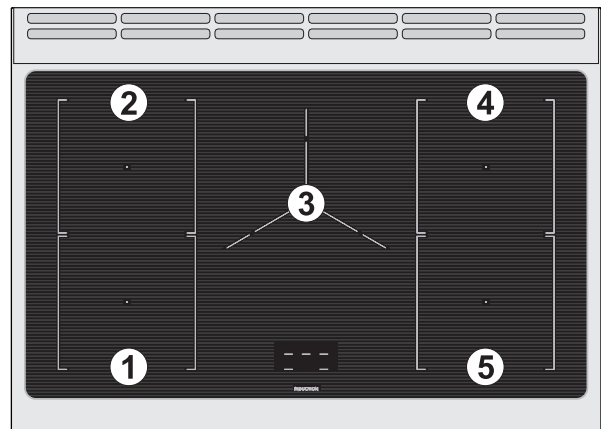

Cooking zones characteristics table

Zone	Dimensions	Max. absorbed power (W)	Max. absorbed power in Boost mode (W)
1-2-4-5 Single zone	180 mm - 7 1/16"	1850	3000
1-2-4-5 Bridge mode	180 mm - 7 1/16"	3700	-
3	260 mm - 10 1/4"	2600	3700

10 FEATURES

Control panel

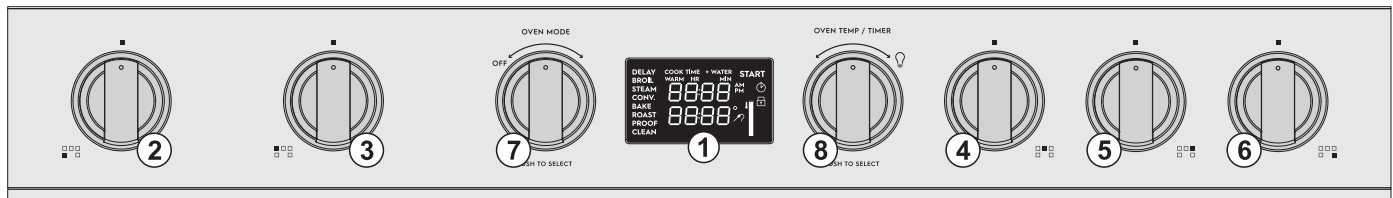

1. Oven display

Cooktop knobs:

2. Cooktop cooking zone knob (front left)



3. Cooktop cooking zone knob (rear left)



4. Cooktop cooking zone knob (central)



5. Cooktop cooking zone knob (rear right)



6. Cooktop cooking zone knob (front right)



The following wording appears on each cooktop knob:

MELT WARM SIM

For the Melt, Keep Warm and Simmer functions.

1 2 3 4 5 6 7 8 9 P

For the cooktop power levels.

B - A

For the Bridge and Heating Accelerator functions.

Oven knobs:

7. Oven mode knob

OVEN MODE

8. Oven temperature knob

OVEN TEMP / TIMER

Cooling fan

The fan cools the oven and comes into operation during cooking.

The fan causes a steady outflow of air that exits from the rear of the appliance, which may continue for a brief period of time even after the appliance has been turned off.

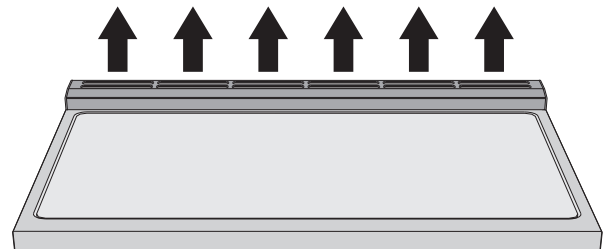

CAUTION

Do not obstruct ventilation openings and heat dispersal slots.

Inside lights

The inside lights can be toggled ON and OFF by turning the oven temperature knob to the bulb icon:

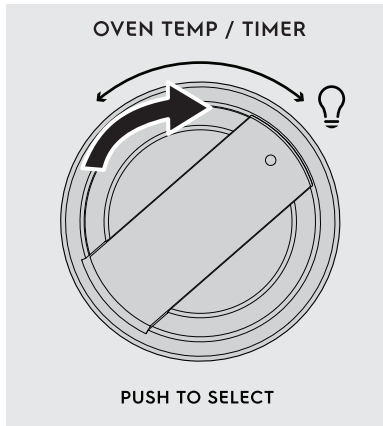

Oven shelf positions

The appliance is fitted with shelf supports to position trays and racks at different heights. The insertion heights are indicated from the bottom upwards.

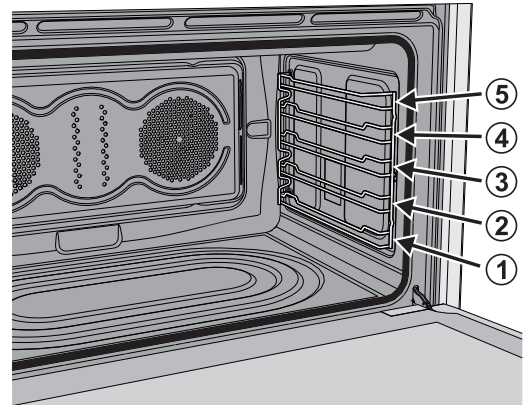

i NOTE

- When the oven display is in standby mode or during cooking, the lights are normally off and can be toggled on in any moment
- The lights cannot be turned on during the Sabbath function.

Cooking Functions table

Function	Min T°	Max T°	Meat Probe	Cook time	Delay
Bake	170°F 75°C	550°F 280°C	Yes	Yes	Yes
Con-vection bake	170°F 75°C	550°F 280°C	Yes	Yes	Yes
Broil	400°F 200°C	550°F 280°C	No	No	No
Con-vection roast	170°F 75°C	550°F 280°C	Yes	Yes (without meat probe)	Yes (without meat probe)
Steam clean	-	-	No	No	Yes
Proof	-	-	No	Yes	No
Warm	160°F 70°C	200°F 90°C	No	No	No
Sabbath	170°F 75°C	550°F 280°C	No	Yes	No

12 FEATURES

Available accessories

Regular rack

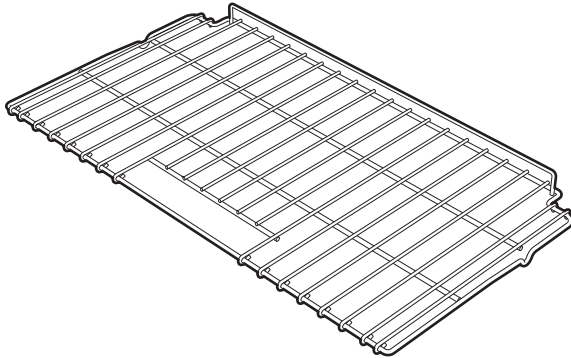

Useful for supporting containers with food during cooking.

Telescopic guide set

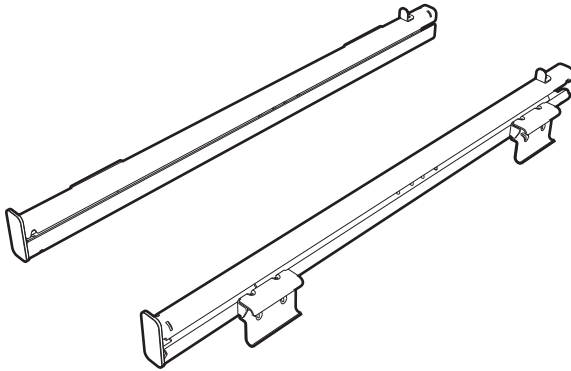

Useful for easily removing the racks from the oven cavity.

Temperature probe



With the temperature probe, you can cook according to the temperature measured at the center of the food.

Protective cover

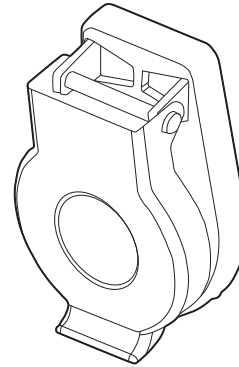

Used to cover and protect the temperature probe socket when the temperature probe is not in use.

i NOTE

- Some models are not provided with all accessories.
- The accessories intended to come into contact with food are made of materials that comply with the provisions of current legislation.
- Supplied and optional can be requested from Authorized Assistance Centers. Use only original accessories supplied by the manufacturer.

Special accessories (not included)

Low backguard

This accessory is an extension of the backguard. It is intended to be mounted over the included backguard as an extended duct for the heat dispersal openings located on the wall-wards side of the range cooktop.

Side fillers

These are aesthetic panels intended to cover the lateral spaces below the rear protruding part of the cooktop.

First power on

Preliminary setup

When setting the clock or a timer, depending on how you turn the knob, you can set a different increase / decrease speed for the settable minutes.

- **Turn and release:** minutes increase / decrease one by one.

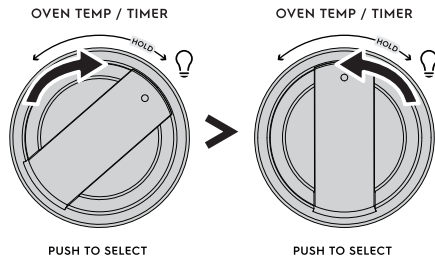

Example: 00:00 > 00:01 > 00:02 > 00:03 > etc.

- **Hold turn:** minutes increase / decrease one by one for the first 3 minutes, then the timer switches directly to the nearest multiple of 15, increasing or decreasing in 15 minute steps.

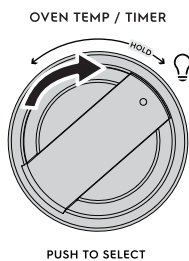

Example: 00:00 > 00:01 > 00:02 > 00:03 > 00:15 > 00:30 > 00:45 > 01:00 > 01:15 > etc.

When setting the minutes you will only see the **MIN** icon. Once 60 minutes have been exceeded the icon

HR will also appear.

Blackout management

After a blackout, there can be two scenarios depending on how long the appliance has been without power.

1. A few seconds to a few minutes: the appliance restores the settings and features set before the power loss event.
2. A few minutes to hours: The appliance does not save the previous settings and will have to be reprogrammed.

First power on

When the range is first plugged in, or when the power supply has been interrupted "12:00 PM" will flash on the timer display.



It will stop flashing once the current time is set up as below.

Setting the display clock

1. Press the oven temperature knob to enable the time selection.
2. The hours can be set by turning the temperature knob towards the right or left. Press the knob to confirm the selection.



3. Repeat the same process for setting the minutes. Press the knob to confirm the selection.

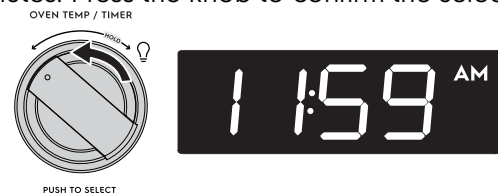

Once the time has been set, the display switches to standby mode where only the current time is shown.

To adjust the display clock after the initial set up, in the stand-by mode, just hold turn the temperature knob left or right for at least 3 seconds, until you see the hour digits flashing.

The instructions to adjust the clock in detail are the same as for setting the clock in the case of the first power on (see "Setting the display clock") starting from point no. 2.

14 BEFORE USING THE APPLIANCE

Cooking with the induction cooktop

Preliminary information

- Each zone of the induction cooktop has its own dedicated display, where the power level and the function symbols are indicated.
- Each zone of the cooktop can be activated by pressing and then turning the relative cooktop knobs.
- Cooktop knobs can only be pressed when they are in the **OFF** position (zone deactivated).
- Once a zone has been activated (knob not in the **OFF** position), simply turn the relative knob to change the power level or to deactivate the zone.

➔ IMPORTANT

To avoid damaging the appliance, do not force the knobs to turn if you have not pressed them first.

What is Electromagnetic induction?

Induction cooking uses electromagnets to create heat in compatible cookware.

Below each cooking zone on an induction cooktop, there is a copper coil. When the cooking zone is turned on, the electricity turns the coil into a type of magnet that heats metal cookware in the cooking zone.

Induction features

Because heat starts in the cookware instead of the cooktop, induction offers several advantages.

Fast Heating: Cookware will heat up faster than on a conventional electric cooktop. Pay close attention to avoid scorching food when starting to cook. You may need to use a lower setting for cooking food than you are used to.

Precise Control: The heat going into the cookware will change immediately when you change the setting of the cooking zone.

Even Heating: Cookware will typically heat more evenly on an induction cooktop, so you are less likely to have hot or cool spots in the cookware.

Cooler Cooktop: An induction cooktop will be cooler when you remove the cookware than a conventional electric cooktop would be. Because the cooktop doesn't get as hot, you are not as likely to get burned. Spills are also less likely to cook onto the surface, making clean-up easier.

Energy Efficiency: Induction cooking wastes less energy than a conventional cooktop, so it uses less electricity.

⚠ CAUTION

Although induction cooking zones do not produce heat, **they can become hot from contact with hot cookware.** Burns may occur if a cooking zone or the surrounding area is touched before it has cooled to a safe temperature.

Sounds

The magnetic field over the induction cooking zone may cause cookware to vibrate, creating a buzzing or humming noise. These sounds are not unusual, especially at high settings.

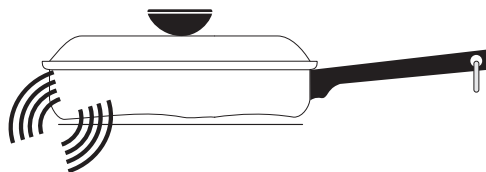

Cookware that is not perfectly flat on the bottom may vibrate slightly against the cooktop.

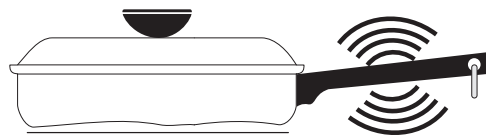

A loose handle may vibrate in its socket.

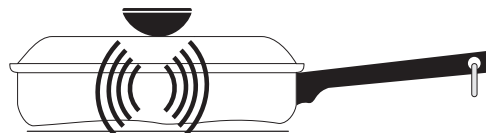

Multi-material cookware may allow small vibrations in its structure.

Sounds are less likely to occur with heavier, higher quality cookware.



An induction cooktop may also produce faint clicking sounds from the electronic switches that maintain the desired cooking temperature. You may also hear a fan that cools the electronics inside the cooktop.

i NOTE

Be sure to read detailed instructions for induction cooktop cleaning in the "Care and Cleaning" section and "Before You Call" checklist section of this Use and Care Guide.

Use the correct cookware type

➔ IMPORTANT

- Each cooking zone is fitted with a magnetic sensor that distinguishes between suitable and unsuitable cookware.
- If unsuitable cookware is used, no heat is generated and no cooking will be performed.
- The alternating symbols  and  appear when improper cookware is used, with missing pan or when you remove the pan during cooking.

The magnetic cooking zone sensors located below the cooktop surface require the use of cookware made with magnetic material in order to start the heating process on any of the cooking zones.

Use only cookware with a perfectly flat bottom suitable for induction cooking. The use of cookware with an irregular bottom could affect the efficiency of the heating system and even prevent the pan from being detected on the cooking zone.

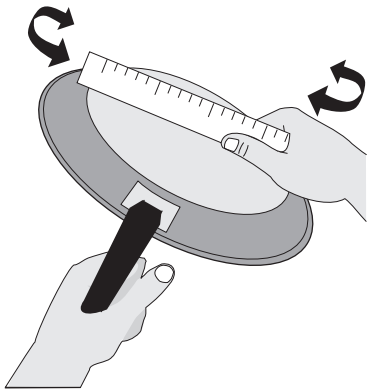

Check for flatness by rotating a ruler across the bottom of the cookware. Cookware should have flat bottoms that make good contact with the entire surface of the heating element.

⚠ CAUTION

Proper cookware on an operating induction cooking zone will heat up very quickly. If an empty piece of cookware is left on an operating induction cooking zone, the rapid change in temperature may warp or damage the cookware.

Do NOT place hot cookware on the control panel. The heat may damage the electronic parts.

Cookware material types

Cookware material is especially important when using an induction cooktop. The cookware must contain magnetic iron or steel to work on an induction cooktop. Common materials for induction cookware include the following:

- **Stainless Steel** - Slow heat conductor with uneven cooking results. Durable, easy to clean, and resists staining. Some types of stainless steel will not work on an induction cooktop. Use the magnet test to check stainless steel cookware.
- **Cast Iron** - A slow heat conductor that retains heat very well. Cooks evenly once cooking temperature is reached.
- **Porcelain-enamel on metal** - Heating characteristics will vary depending on the base material. Porcelain-enamel on a compatible metal will work on an induction cooktop. Use the magnet test to check porcelain-enamel cookware.

Cookware sold as induction-ready will often have a symbol printed on the bottom by the manufacturer.

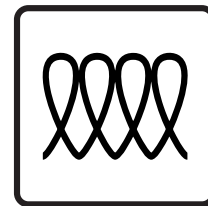

The magnet test

To see if a piece of cookware will work on your induction cooktop, try to stick a magnet to it. If the magnet clings firmly to the bottom of the cookware, the cookware will work on your induction cooktop. If the magnet clings weakly or not at all, the cookware will not heat up on your induction cooktop.

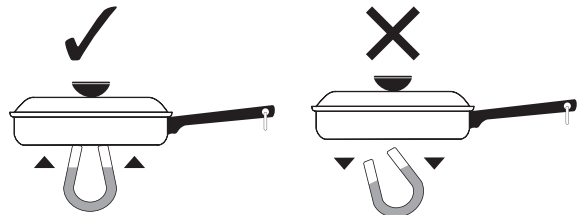

16 USING THE COOKTOP

Minimum pan size requirements

USE THE CORRECT SIZE COOKWARE - The cooking zones available on the Induction cooktop require a MINIMUM pan size to be used at each location. We recommend using cookware with a diameter that allows efficient cooking.

Below is a summary table showing the recommended diameter of the cookware for each cooking zone.

Cookware diameters table		
Zone	Cooking zone mode	Recommended diameter
1-2-4-5	Single zone (1)	145 mm - 5" 6/8
1-2-4-5	Single zone in Bridge function (2)	145 mm - 5" 6/8
1-2-4-5	Double zone in Bridge function (3) *	300 mm - 11" 6/8
3	Single zone	230 mm - 9" 1/8

Example of correct pan arrangement on cooking zones 1 - 2 - 4 - 5:

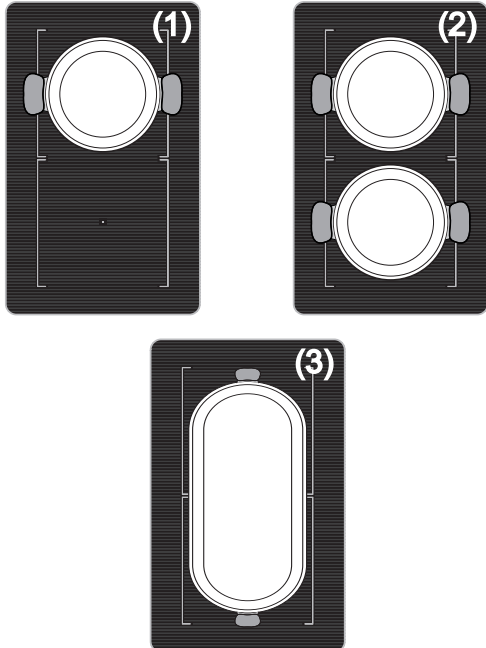

* In the (3) case, the measurement refers to the length of a an elongated pan. For the width of this pan keep a maximum of 200 mm - 7" 7/8.

First power on

When the range is first plugged in, or when the power supply has been interrupted, all the symbols on the cooktop display light up for one second.

Cooktop power management

The cooktop is equipped with a power management module which optimizes or limits energy consumption. If the total power levels set exceed the maximum allowed limit, the electronic board automatically manages the power supplied to the cooking zones.

The levels set by the automatic management system are shown on the display.

A flashing a power level icon indicates that it will be automatically limited to a new value selected by the power management module.

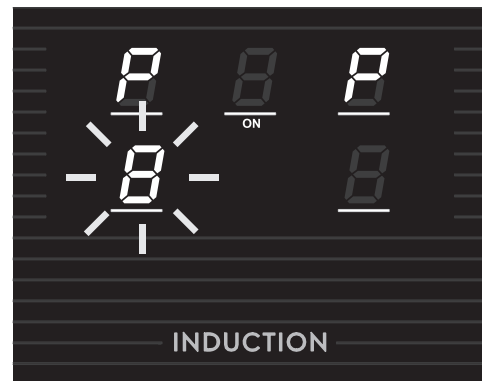

➔ IMPORTANT

Priority is given to the last set zone.

Cooktop operation time limitation

The cooktop is equipped with an automatic device that limits its duration of use.

If you do not change the cooking zone settings, the maximum operating duration of each individual zone depends on the power level selected.

When the device for limiting the operating time is activated, the cooking zone switches off, a short signal is emitted and if hot the symbol appears on the display.

Maximum cooking duration table	
Power level selected	Maximum duration of use in hours/minutes
1	8 hours
2	6 hours
3 - 4	5 hours
5	4 hours
6 - 7	1 ½ hours
8 - 9	1 ½ hours
P	10 minutes

CAUTION

Protection from overheating

- If the cooktop is used at full power for a long period of time, the internal electronics may have difficulty cooling if the room temperature is high.
- To prevent excessively high temperatures from forming inside the cooktop, the power of the cooking zone is automatically lowered.

Switching on the cooking zones

To switch on a cooking zone, press and then turn the corresponding knob clockwise. A short beep will be emitted.

The corresponding display shows the selected power level, "ON" appears below the central cooking zone display and all the other cooking zone displays briefly display "0" and then go off. (the example shows the front left cooking zone at level 3).

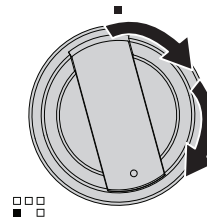

Turning off the cooking zones

To switch off a cooking zone, simply turn the corresponding knob to "OFF". All the cooking zone displays show flashing red dots at their lower right corner and the word "ON" below the central cooking zone display for 10 seconds.

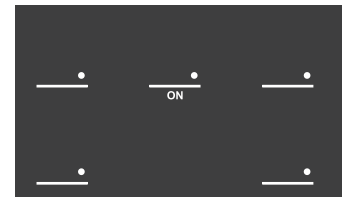
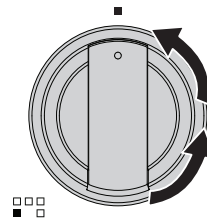























Induction cooktop residual heat

After the cooking zones have been switching off, if they are still hot the corresponding displays shows the flashing symbol . When the temperature drops below the safety threshold, the symbol disappears.

18 USING THE COOKTOP

Power levels

The power of the cooking zone can be adjusted to various levels. Information on the different types of cooking can be found in the table. All power levels are available for all cooking zones.

Cooking zone power levels table	
Power level selected	Suitable for...
Melt function  /  MELT	Melting butter, chocolate or similar.
Keep Warm function  /  WARM	Warming dishes and keeping small amounts of water boiling, whisking egg yolk or butter sauces.
Simmer function  /  SIM	Heating solid or liquid foods, keeping water boiling, thawing frozen foods, making 2- or 3-egg omelets, fruit and vegetable dishes, various preparations.
 -  / 	Cooking small amounts of food (minimum power).
 -  / 	Cooking large amounts of food.
 -  / 	Cooking large amounts of food, roasting.
 -  / 	Roasting.
 / 	Roasting larger pieces, frying with flour.
 /  *	Roasting, frying, cooking (maximum power).

* See boost mode

Boost mode

➔ IMPORTANT

After 10 minutes of operation in Boost mode, the cooktop automatically brings the power to level 9.

A Booster function allows you to activate the cooking zone on the maximum power for up to 10 minutes. Useful for bringing a large quantity of water quickly to the boil or cooking meat over high heat.

To activate Boost mode (the example shows the front left cooking zone):

1. Press a cooktop knob.
2. Turn the knob all the way clockwise to level 9.

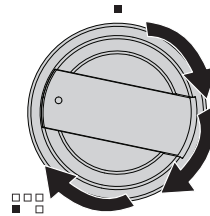

3. Turn clockwise again to position **P** and hold until  is shown on the corresponding cooking zone display (a beep will be emitted).

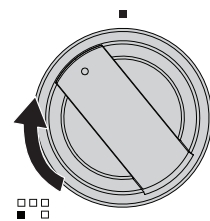

4. Release the knob.

To deactivate Boost mode, simply bring the knob to the **OFF** position or select another power level.

Heating accelerator function

This function allows you to bring the cooking zone to the selected power level more quickly than when selecting the power level.

To activate the Heating accelerator function (the example shows the front left cooking zone at level 3):

1. Press and hold a cooktop knob.
2. Keep the knob pressed and turn it counterclockwise to position **B-A** until the **A** symbol appears on the corresponding cooking zone display (a beep will be emitted).

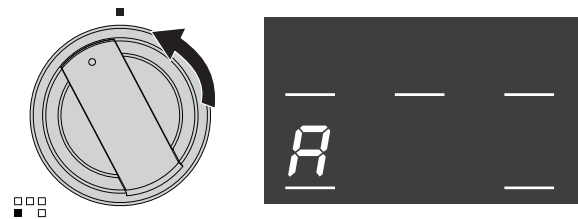

3. Keep the knob pressed and select the required power level within 3 seconds. The corresponding cooking zone display will show **A** and the selected power level number alternating.



→ IMPORTANT

Once the selected power level is reached, the Heating accelerator function will be deactivated (the **A** symbol will disappear) and the power level will remain the selected one.

You can increase the power level at any time. The "acceleration" time frame will be modified automatically.

To deactivate the Heating acceleration function, simply bring the knob to the **OFF** position or select a lower power level.

Bridge function

→ IMPORTANT

- This function is only available for pairs of front and rear zones (1 - 2 and 4 - 5). All the other zone combinations are not allowed.
- With the bridge function activated, it is not possible to activate Boost mode.

The bridge function allows you to control two cooking zones simultaneously. This function is useful when cooking with oblong cookware such as roasting pans or fish kettles, or when cooking with two pans at the same time.

To activate the Bridge function:

1. Press and hold turn the front / rear left or right knobs counterclockwise to the **B-A** positions (a short beep will be emitted):

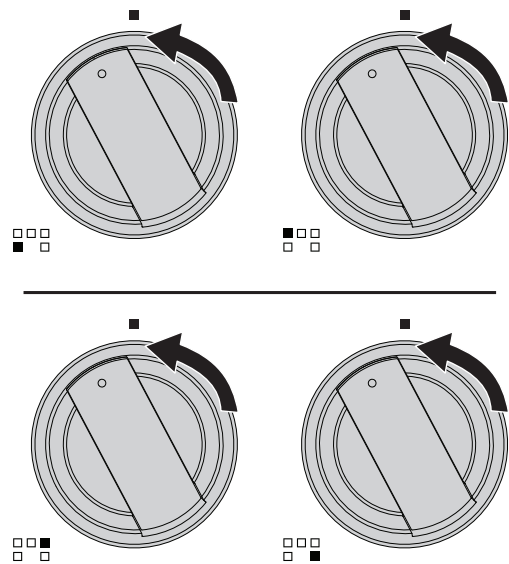

2. Release the knobs.

20 USING THE COOKTOP

3. Press and turn the rear left or the front right cooking zone knobs until you reach power level 9 (a long beep will be emitted).

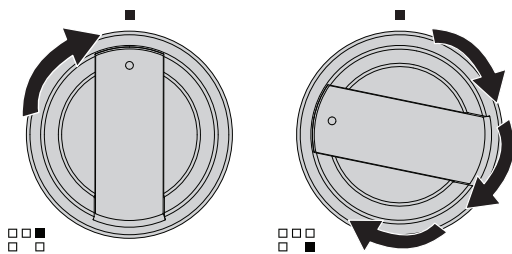
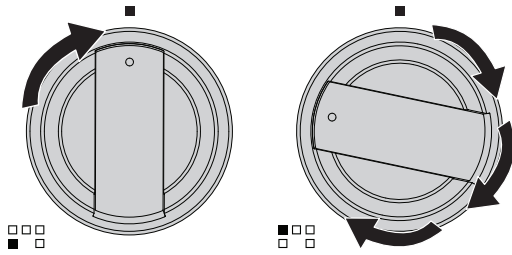

Now both cooking zone displays shows level 0 and flashing red dots appear on all displays. The Bridge function is now activated.

4. You can control both the linked zones using the front left or rear right cooking zone knobs.

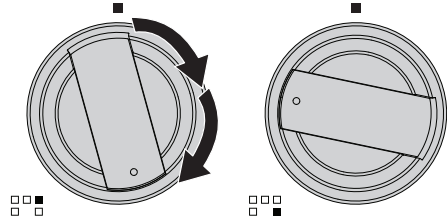
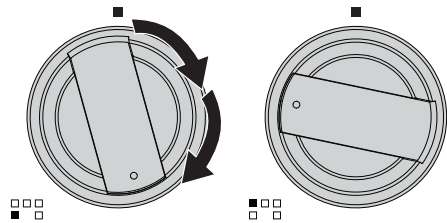

To deactivate the Bridge function, bring both knobs to the **OFF** position.

i NOTE

This function automatically distributes an equal amount of power over both the zones involved.

Control Lock

The control lock is a device that protects the appliance from accidental or inappropriate use. Only the cooktop knobs will be locked.

To activate the Control Lock:

1. Press and hold turn the central cooking zone knob counterclockwise to the **B-A** position until all the cooking zone displays show the  symbols (two short beeps will be emitted in the meantime):

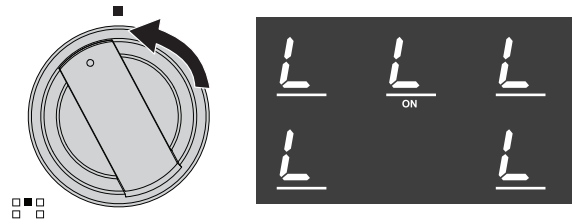

To deactivate the Control Lock, follow the instructions in point 1 until the  symbol disappears.

➔ IMPORTANT

- After about 10 seconds without interacting with the cooktop knobs, the cooking zone displays will be turned off. To check if the Control Lock is active or not, simply try to turn on any cooking zone.
- When you activate Control Lock, if you turn and hold the central cooking zone knob for more than 30 seconds, the flashing symbol  will appear as an error message. Release the knob to remove it.

Oven preparation

CAUTION

Remove all accessories, materials and literature from the inside of the oven before performing this operation.

Prepare your range for first time use by setting Bake function at 350°F (175°C) for about 30 minutes. (see "Timed cooking"). This allows the inside of the oven to remove eventual manufacturing residues. Some smoke and noises during this time is normal.

Using the accessories

CAUTION

- Always use potholders or oven mitts when removing food or adjusting the oven racks and guides. Wait until the oven has cooled down completely, if possible. Oven accessories may be HOT and may cause burns.
- If the rack has to be moved while the oven is still hot, do not let oven mitts come into contact with heating elements.
- Be careful when removing oven racks from the lowest rack position to avoid contact with the hot oven door.
- To avoid possible injury or damage to the appliance, ensure that racks are installed correctly and not backwards or upside down.
- To avoid damage to the enameled and chromed surfaces, be very careful when inserting and removing the telescopic guides.

Regular rack

CAUTION

- Be careful to insert the rack in the correct spaces indicated by the dashed lines:

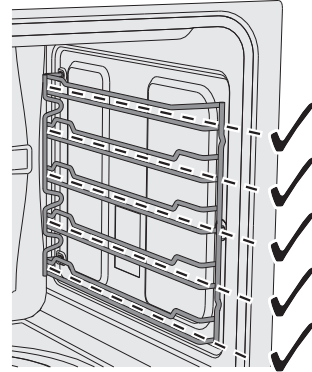

- Part **A** of the rack must face towards the outside of the oven and part **B** must face upwards.

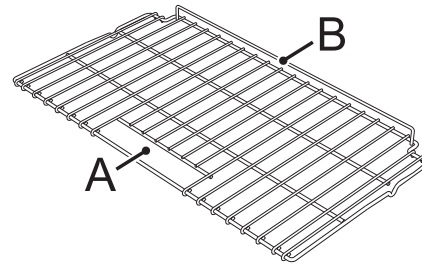

The rack is fitted with mechanical safety locks that prevent it from being removed by accident:

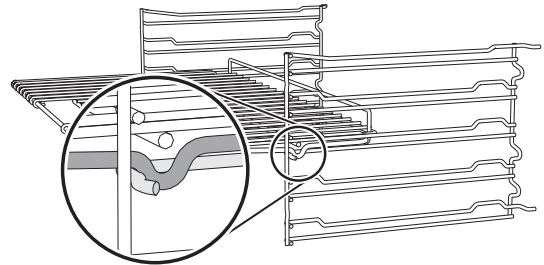

To insert the rack:

1. Grip the rack firmly on both sides.
2. Keep the front of rack slightly tilted upwards and rest the rear part in one of the spaces indicated.
3. Gently slide in the rack until it comes to a complete stop.

22 USING THE OVEN

To remove the rack:

1. Slide out the rack until it stops due to the mechanical safety locks.
2. Slightly lift it upwards and pull it all the way out.

Telescopic guides

CAUTION

- Be careful to hook the telescopic guides in the correct spaces indicated by the dashed lines. To avoid damaging the appliance the top shelf position is not designed for the guides to be inserted.

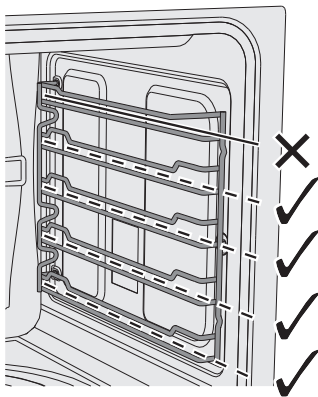

- Part **A** of the guides must face towards the outside of the oven and part **B** must face inwards.

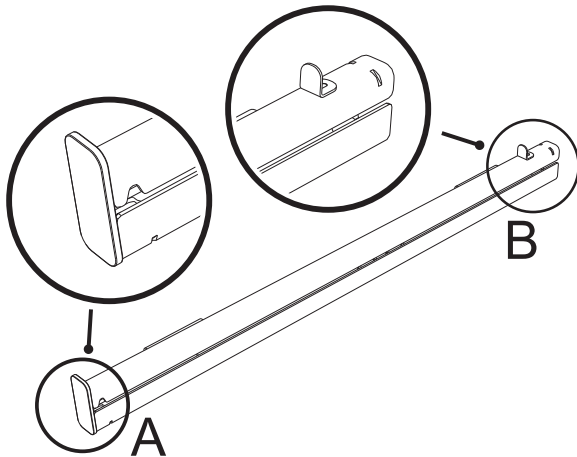

To install the telescopic guides:

1. Slightly tilt the guides towards the inside wall of the oven (1) and rest its hooks on the raised parts of the oven shelf supports (2).

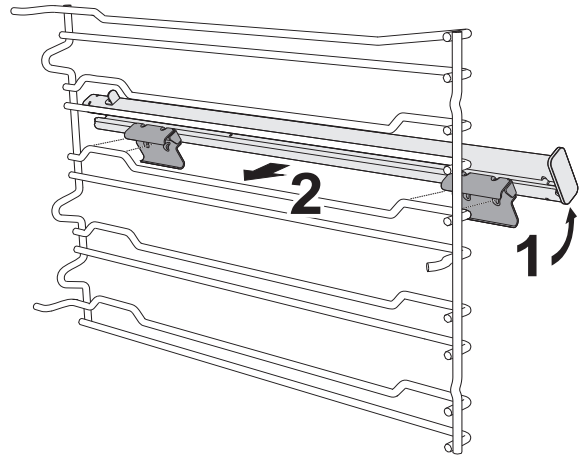

2. Turn the guides in order to lock the lower part of the hook onto the lower part of the shelf support.

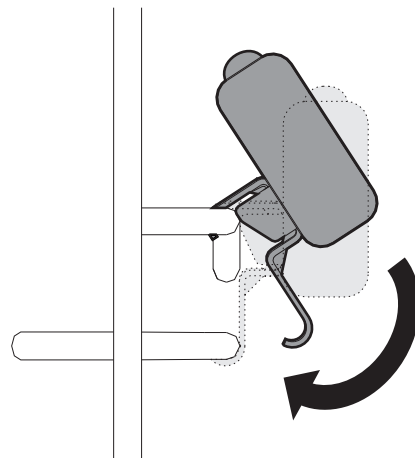

CAUTION

Ensure that the telescopic guides have been installed correctly and securely.

IMPORTANT

To avoid damaging the guides, pull them out and push them in gently.

The telescopic guides allow a two stage extraction:

- Partial extraction:

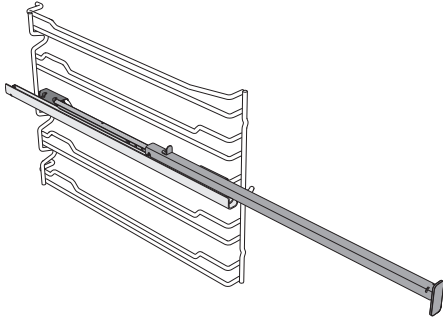

- Total extraction:

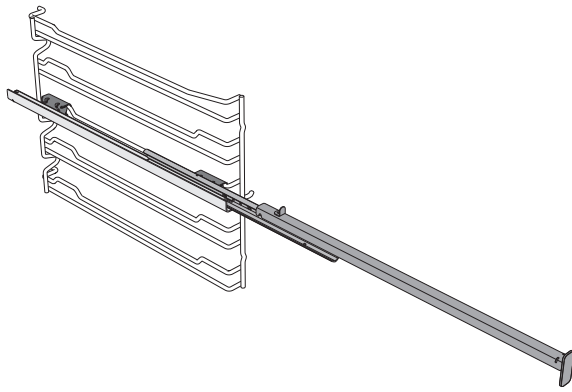

When using the guides, extract the guides completely and gently place the rack on them.

Take care to position the rack on the guides as shown in the figure below.

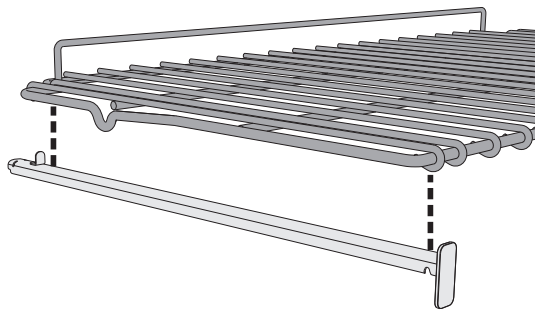

To remove the telescopic guides, follow the installation instructions in reverse.

CAUTION

Wear protective gloves when removing the guides.

Temperature probe

WARNING

- Do not leave the temperature probe unattended.
- Do not allow children to play with the probe.
- Take care not to hurt yourself on the sharp parts of the probe.

CAUTION

- Do not touch the rod or the tip of the probe after having used it.
- Wear oven mitts when handling the temperature probe.
- Take care not to scratch or damage enameled or chrome-plated surfaces with the tip or the plug of the temperature probe.
- Do not insert the probe into openings and slots on the appliance.
- Only use the temperature probe provided or recommended by the manufacturer.
- When the probe is not in use, make sure that the protective cover is properly closed.

IMPORTANT

- Do not pull the cable to remove the probe from the socket or from the food.
- Make sure that the probe or its cable do not get caught in the door.
- No part of the probe should be allowed to come into contact with the walls of the oven cavity, the heating elements, the rack or the guides when they are still hot.
- When not in use, the probe should not be kept inside the appliance.
- Make sure the plug of the probe is fully inserted into the socket.
- Do not use the probe to place food into or to remove it from the oven cavity.

With the temperature probe, roasts, pork loin and various cuts and sizes of meat can be cooked to perfection.

The probe, in fact, allows foods to be cooked to perfection because it accurately monitors the core temperature of the food.

The core temperature of the food is measured by a sensor located in the tip of the probe.

24 USING THE OVEN

For cooking with the temperature probe see “Meat probe cooking”.

Cooking with the oven

With this range, you can bake many kinds of food in several ways.

Four different cooking functions are available: different heating elements, combinations of them and internal fans will be activated, according to the type of dish you intend to cook.

List of cooking functions

DELAY
BROIL
STEAM
CONV.
BAKE
ROAST
PROOF
CLEAN

Bake

This function is best used for your standard recipes. This function is suitable for cooking one dish at a time. Perfect for bread, biscuits, cookies and similar dishes.

DELAY
BROIL
STEAM
CONV.
BAKE
ROAST
PROOF
CLEAN

Convection bake

This function allows different foods to be cooked on several levels extremely quickly and efficiently, without odors and flavors mingling. Recommended for leavened cakes and muffins.

DELAY
BROIL
STEAM
CONV.
BAKE
ROAST
PROOF
CLEAN

Broil

This function gives perfect grilling results, especially for thin and medium thickness meat and gives the food an even browning at the end of cooking. Perfect for sausages, spare ribs, bacon, fish and shrimps. This function enables large quantities of food to be grilled evenly.

DELAY
BROIL
STEAM
CONV.
BAKE
ROAST
PROOF
CLEAN

Convection roast

The combination of the fan and heating elements allows you to cook both on single level and on several levels. Hot air circulation ensures instant and even distribution of heat. This function is suggested for the simultaneous cooking of different types of food, as long as they need the same temperatures and same type of cooking. Recommended for tender cuts of beef, lamb, pork and poultry.

NOTE

Each cooking function has its own auto-suggest (default) temperatures.

- Bake: 350°F / 175°C.
- Convection bake: 325°F / 165°C.
- Broil: 550°F / 280°C.
- Convection roast: 350°F / 175°C.
- Warm: 170°F / 75°C.
- Sabbath: 350°F / 175°C.

Manual cooking

Preliminary information

- The word “**START**” flashes in the upper right corner of the display to indicate that it is possible to start the selected function.
- Once a function is started or when setting the temperature and timing functions the word “**START**” disappears.
- When you select a function you can set the temperature, the minute minder (see “Cooking timer”), the cooking time (see “Timed cooking”) and the delay time (see “Delayed cooking”) exactly in this order.
- Every function can be paused at any time by simply opening the door. During the pause the inside lights turn on, the heating elements are deactivated as well as the oven fan (if the function provides for fan activation) and the flashing word “**START**” appears. Close the door to resume the function (the word “**START**” disappears).

IMPORTANT

It is not possible to set the temperature and all the timing for all functions.

- When setting the temperature and the timing functions, the relative symbol/word starts flashing:

- Temperature: 
- Stand alone timer / cooking timer: 
- Timed cooking: **COOK TIME**
- Delayed cooking: **DELAY**

- Move through the temperature setting and the timing functions by pressing the oven temperature knob. Change the relative values by turning the oven temp. knob left or right
- The temperature and the timing functions can be set or reset during cooking.
- To cancel the timing functions, simply set the relative values in minutes / hours to zero.
- While setting a function or when a function is in progress, it always possible to go in standby mode by turning the oven mode knob to the left and then releasing it. Doing so will cancel the cooking settings or stop the cooking function.

To set a manual cooking cycle

- Press the oven mode knob. The default screen will show:

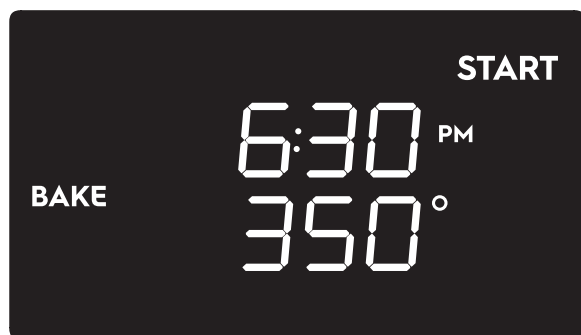

- Turn the oven mode knob to select the cooking function. If you keep turning the knob, you can select the auxiliary functions and the special functions (see "Auxiliary functions" and "Special functions").
- Turn the oven temperature knob to the left or right to select the temperature.
- Once the cooking function and temperature have been selected, press the oven mode knob to start cooking (the word "START" disappears)

Manual cooking in progress

- Manual cooking can be stopped at any time by turning the oven mode knob to the left
- Open the door to pause cooking. Close the door to resume cooking.
- Turn the oven temperature knob to the right to turn on and off the lights.
- The temperature can be changed by pressing and then rotating the temperature knob. The timing functions can be selected by pressing the temperature knob again (see "Timing functions"). You can change the temperature and the timing functions by pressing and turning the temperature knob even during the pause.

NOTE

At the end of any function, a buzzer is triggered and sounds twice every 15 seconds (except for the Sabbath function).

Preheating

NOTE

At the start of each cooking cycle, the oven will preheat in order to reach the selected cooking temperature (except for Convection roast and Sabbath functions).

The bake, convection bake and broil functions are always preceded by preheating, during which the oven is heated to the set cooking temperature.

The temperature bar is shown on the right hand side of the display. The  icon and the bar segments flash to indicate that the oven temperature is increasing.

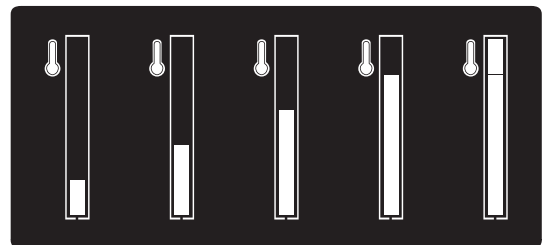

When preheating is complete, the temperature bar segments and the  icon become steady.

The duration of preheating varies according to the temperature and the cooking function selected.

26 USING THE OVEN

A buzzer sounds to signal the end of preheating. Open the oven door to stop the buzzer.

→ IMPORTANT

There is no preheating for the convection roast function. When starting to cook using the convection roast function the display immediately shows the full temperature bar.

Oven residual heat

When the display is in standby mode and the oven cavity is still hot, the decreasing temperature bar will be shown at the right side of the screen.

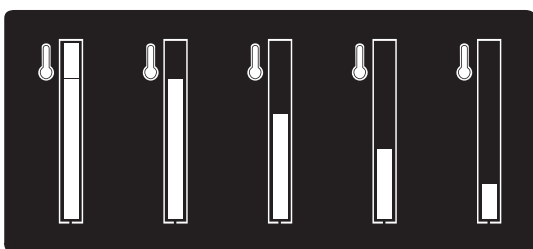

The temperature bar will disappear when the oven cavity temperature decreases to below 140°F (60°C).

Timing functions



Minute minder

The function of this timer is only to warn the user when the set time has expired. It does not stop any function in progress. It can be activated either as a stand alone timer or when setting a function, but its operation is the same.

COOK TIME

Timed cooking

This timer stops the function in progress when the time has elapsed. It can only be activated when setting a function.

DELAY

Delayed cooking

This timer allows you to start a function after the preset time. It can only be activated when setting a function and when timed cooking has been set.

Minute minder

i NOTE

- The minute minder can be set both during cooking and as a stand alone timer.
- A minimum of 1 minute and a maximum of 12 hours can be set

The minute minder allows you to set a timer and a buzzer will sound at the end of the set time.

Stand alone timer

The stand alone timer can be useful when cooking with the induction cooktop.

With the display in standby mode:

1. Press the temperature knob. The screen will show:



2. Turn the temperature knob left or right to set the time.
3. Press the temperature knob to start the timer.

During the countdown, you can change the previously set time by pushing and rotating the temperature knob. Push the knob again to resume the timer countdown.

When the timer expires, a buzzer sounds and the clock icon starts to flash.

To stop the buzzer, simply interact with one of the oven knobs or open the door, then the display switches to standby mode.

Cooking timer

This timer mode acts as a stand alone timer during a function in progress.

1. Set a manual cooking cycle (See “Manual cooking”) (example is a 350°F Bake).
2. Press the oven temperature knob until the display shows the **MIN** and  icons and the number “:00”.



3. Set the time by turning the temperature knob.
4. Keep pressing the temperature knob until “START” flashes on the display. The countdown starts immediately.
5. Press the oven mode knob to start cooking.

Cooking timer in progress

During cooking you can change or deactivate the cooking timer by pressing the oven temperature knob until the display shows the number of minutes/hours that were previously selected.

1. To reset the timer, keep the temperature knob turned to the left until you reach “:00”.
2. To change the timer, turn the temperature knob left or right to select another countdown.
3. Keep pressing the temperature knob until the display shows the current time or the new countdown in progress.

→ IMPORTANT

- If cooking is paused, the countdown anyway continues.

End of cooking timer

When the timer expires, a buzzer sounds and the following screen appears on the display with the  icon flashing.



To stop the buzzer, simply interact with one of the oven knobs or open the door, then the display switches to the cooking in progress screen.

Timed cooking

→ IMPORTANT

The timed cooking is allowed for all functions except Warm, Steam clean and Broil.

The timed cooking allows you to stop the cooking process after a preset time.

1. Set a manual cooking cycle (See “Manual cooking”) (Example is a 350°F Bake).
2. Press the oven temperature knob until “**COOK TIME**” flashes on the display.

→ IMPORTANT

On this screen, if you do not interact with the knobs for 5 seconds, the display switches to the cooking settings screen.



28 USING THE OVEN

3. Turn the temperature knob left or right to set the time.
4. Press the temperature knob until the display shows the cooking settings screen with the cooking time just set and the word **"START"** flashing.
5. Press the oven mode knob to start the timed cooking.

Timed cooking in progress

When the cooking is in progress, by pressing and turning the temperature knob, you can:

1. Change the temperature.
2. Set a minute minder timer.
3. Change or reset the timed cooking countdown. If you reset the countdown, cooking switches to manual mode.

Open the door to pause cooking.

You can change the temperature and the timing functions by pressing and turning the temperature knob even during the pause.

Close the door to resume cooking.

To stop cooking, turn and release the oven mode knob to the left.

End of timed cooking

At the end of cooking, a buzzer sounds and **"End"** will appear on the display together with the current time.

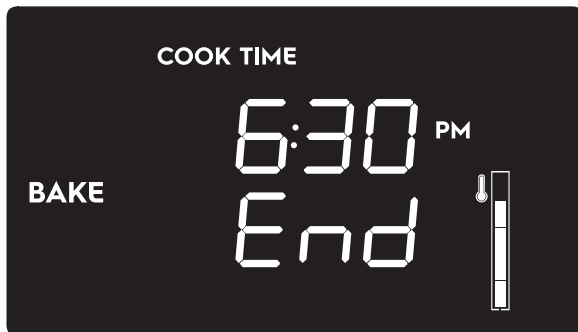

By turning and releasing the oven mode knob to the left or after a few seconds of waiting, the display switches to the standby screen (current time only) with the decreasing temperature bar to indicate that the oven cavity is still hot.

Delayed cooking

IMPORTANT

- Delayed cooking can only be selected if a timed cooking has been set
- Delayed cooking is allowed for all functions except Warm, Proof and Broil.
- The minimum settable delay is 1 min.
- For the Warm function, the max. settable delay is 12 hours; for all the other functions it is 1 hour.

The delayed function allows you to start a timed cooking automatically after a preset time.

To set a delayed function:

1. Set a timed cooking function (see "Timed cooking") (Example is 350°F Bake).
2. Once the cooking duration has been set, press the temperature knob until the following screen is displayed with the word **"DELAY"** flashing:

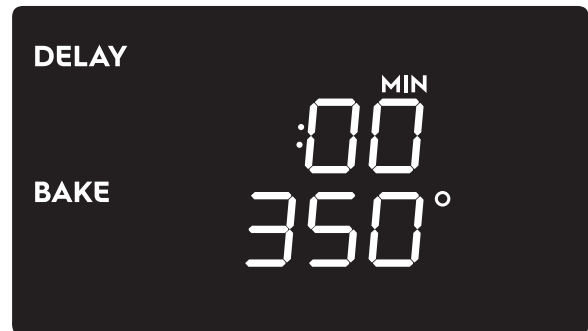

3. Turn the temperature knob left or right to select a delay time.
4. Press the temperature knob to switch to the cooking settings screen.
5. Press the oven mode knob to start the delay countdown. During this phase, the display is less bright.
6. Once delay countdown ends, the brightness of the display returns normal and timed cooking starts.
7. At the end of timed cooking follow the same instructions described previously for timed cooking (see "End of timed cooking").

Auxiliary functions

Three auxiliary functions are available, selectable in the same way as the cooking functions.

DELAY
BROIL
STEAM
CONV.
BAKE
ROAST
PROOF
CLEAN

Steam clean

This function is an assisted cleaning procedure that facilitates dirt removal. This function allows the inside of the oven can be cleaned with great ease. Dirt residues are softened by the steam produced by heating a small amount of water on the bottom of the oven cavity.

DELAY
BROIL
STEAM
CONV.
BAKE
ROAST
PROOF
CLEAN

Proof

This function allows to create the perfect environment to activate yeast when baking homemade breads or pizza using heat coming only from the upper part of the oven cavity.

WARM

Warm

This function allows you to maintain a constant temperature inside the oven. Useful to prevent freshly cooked food from cooling down.

Steam Clean

For the details on setting and starting the Steam Clean function see the dedicated chapter.

Proof

→ IMPORTANT

- When you select the Proof function the **"COOK TIME"** appears on the display to indicate that the default duration of this function is 1 hour.
- It is not possible to set a delayed start for this function.
- For best results, a container of water should be placed at the bottom of the oven cavity.

Preliminary operations:

1. Open the oven door.
2. Place the container containing the dough in the oven.
3. Close the oven door.

To set the Proof function:

1. Press the oven mode knob.
2. Turn the oven mode knob until the Proof setting screen appears on the display (the word **"START"** flashes):



3. By pressing the oven temp. knob you can set a minute minder timer or change the default duration of the function (see "Cooking timer" and "Timed cooking").
4. Press the oven mode knob to start the Proof function (the default/user countdown starts and the word **"on"** disappears).

Proof function in progress

By pressing and turning the oven temp. knob, you can modify the minute minder and the duration of the function (see "Cooking timer" and "Timed cooking").

Open the door to pause function.

You can change the temperature and the timing functions by pressing and turning the temperature knob even during the pause.

Close the door to resume function.

Turn the oven mode knob to the left and then release it to stop the function.

30 USING THE OVEN

End of Proof function

At the end of the Proof function, a buzzer sounds and “END” will appear on the display together with the current time.

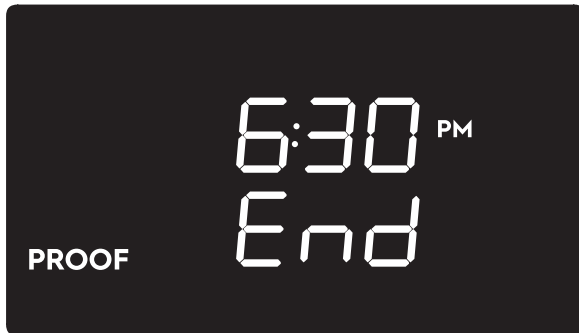

Turn and release the oven mode button to stop the buzzer and the function. The display goes into standby mode.

Warm

NOTE

The temperature range for this function is from 160°F (70°C) to 200°F (90°C).

To set the Warm function

1. Press the oven mode knob.
2. Turn the oven mode knob until the Warm setting screen appears on the display (the word “START” flashes):

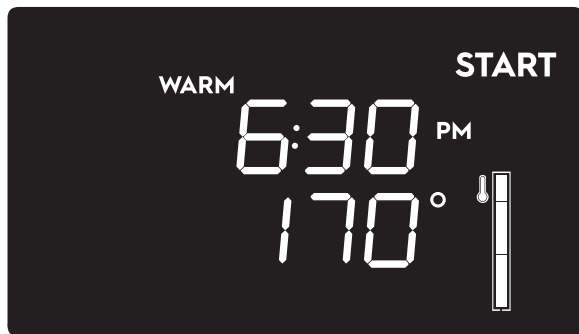

3. Press turn and release the oven temp. knob to change the Function temperature.
4. Press turn and release the same knob again and to set a function timer.
5. Press oven temp. knob again to confirm the timer and to switch to the Warm setting screen.
6. Press the oven mode knob to start the Warm function.

Warm function in progress

You can modify the temperature and duration of the function by pressing and turning the oven temp. knob. Open the door to pause function.

You can change the temperature and the timing functions by pressing and turning the temperature knob even during the pause.

Close the door to resume function.

Turn the oven mode knob to the left and then release it to stop the function.

End of Warm function

At the end of the Warm function, a buzzer sounds and “END” will appear on the display together with the current time.

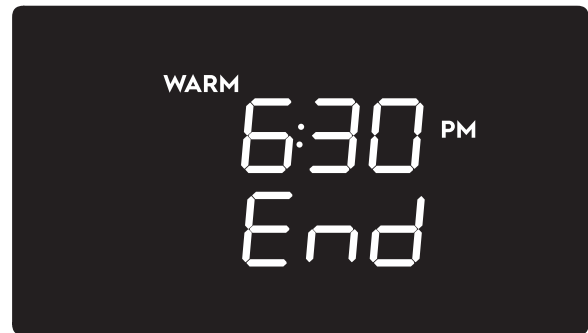

Turn and release the oven mode button to stop the buzzer and the function. The display goes into standby mode.

Special functions

Two special functions are available, selectable in the same way as the cooking and auxiliary functions.



Sabbath

Function that allows you to cook food whilst respecting the provisions of the Jewish day of rest. This function has the same characteristics as the Bake function.



Meat probe cooking

Useful function for cooking various types of meat to perfection by measuring the core temperature of the meat. This is not a timed cooking function: the cooking process ends when the probe sensor reaches the set target temperature.

Sabbath function

The Sabbath function operates the appliance in a particular way:

- The maximum operating time is 74 hours.
- A timed cooking from 10 minutes to a maximum of 74 hours can be set.
- No minute minder timer is allowed.
- No delayed cooking is allowed.
- No preheating will be performed.
- The internal fans remain off.
- The oven lights cannot be toggled on.
- No sound will be emitted.

To set the Sabbath function:

1. With the display is in standby mode, press the oven mode knob to access the cooking settings screen.
2. Turn it once to the left. The display below will appear ("START" will flash):

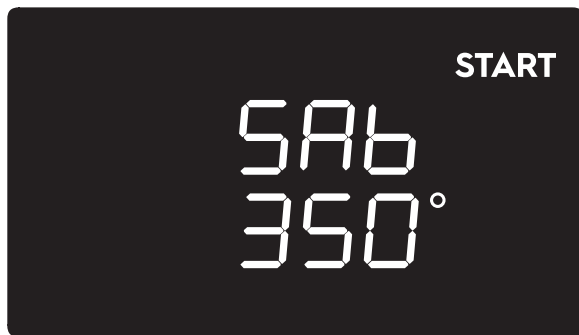

3. Press and turn the oven temperature knob once to change the temperature (the degrees symbol starts flashing).
4. Press the temp. knob again to set a timed cooking (the default duration is 1 hour).
5. Turn the temp. knob to change the timed cooking duration.
6. Press the temp. knob again to confirm the previous selections and to switch to the cooking settings screen.
7. Press the oven mode knob to start the function.

Sabbath function in progress

When the Sabbath function is in progress, no action is allowed except to stop cooking by rotating the oven mode knob to the left. Only the word "SAb" is shown on the display.

End of Sabbath function

You can end the Sabbath function in any moment by turning and releasing the oven mode knob. The display goes into time of day mode.

When the timed Sabbath cooking function has ended or the maximum 74 hours are reached, the display shows:



In this state the oven doesn't generate heat but the Sabbath function is still active. This screen remains indefinitely until you turn the oven mode knob. By turning the oven mode knob the display will show the time of day screen.



After a power failure event the display shows the above screen, the Sabbath function will be stopped and an eventual timed function will be canceled.

In any case, when the display shows the above screen it is not possible to toggle on the lights, neither by opening the door nor by turning the temperature knob to the right.

32 USING THE OVEN

Meat probe cooking

→ IMPORTANT

- Meat probe cooking is allowed only with Bake, Convection Bake and Convection Roast functions.
- If you use the meat probe with any other cooking function, the  icon starts to flash (except for the Sabbath function).
- With the meat probe inserted, it is not possible to set a minute minder timer when setting a cooking cycle or during a cooking.
- If you insert the meat probe when a timed Bake, Conv. Bake or Conv. Roast is in progress, the timer will be canceled and the function continues using the default temperature or the set temperature of the meat probe.
- If you insert the meat probe when other timed cooking functions are in progress, the  icon starts to flash and the cooking process will go ahead ignoring the meat probe.
- If the meat probe is inserted when the display is in standby mode, the  icon starts to flash, but it is still possible to set a stand alone timer.

Preliminary operations

1. Open the oven door.
2. Place the food on the rack.
3. Insert the tip of the probe into the food before placing it in the oven.

→ IMPORTANT

- Always insert the probe so that the tip is in the center of the thickest part of the meat. Do not allow the probe to touch bone, fat, gristle or the pan.
- Make sure that the tip of the probe does not protrude from the food.

4. Insert the plug of the probe into the socket on the left the side of the oven cavity. The  icon starts flashing.

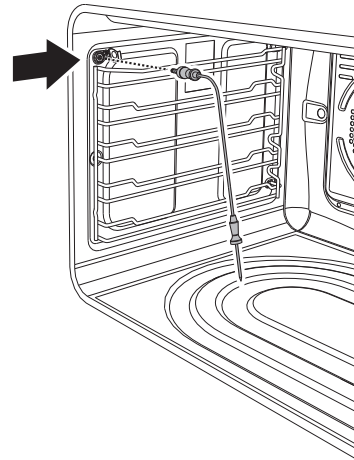

5. Place the rack with the food to be cooked in the oven.
6. Close the oven door.

To set a meat probe cooking

→ IMPORTANT

When setting a meat probe cooking cycle there two temperature values have to be selected:

- Oven cavity temperature: Min. 170°F (75°C) - Max. 550 °F (280°C) - Default: 350°F (175°C).
- Meat probe target temperature: Min. 100°F (38°C) - Max. 200°F (90°C) - Default: 160°F (70°C).

1. Press the oven mode knob.
2. Select a function enabled for meat probe cooking. The  icon becomes steady and the word "START" flashes.



- Press the oven temp. knob to change the oven cavity temperature. The display will show the default cavity temperature at the bottom with the flashing degree symbol. The word **"START"** disappears.



- Turn the oven temp. knob to change the cavity temperature.
- Press the oven temp. knob to confirm the selection and to allow the probe target temperature to be changed (shown at the bottom).

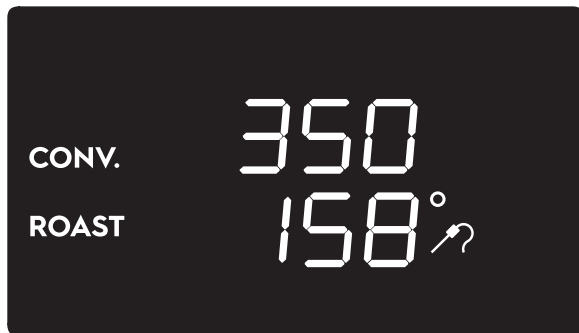

- Turn the oven temp. knob to change the probe target temperature.
- Press the oven temp. knob to confirm the selection and switch to the probe cooking settings screen. The word **"START"** begins to flash again.
- Press the oven mode knob to start the Meat probe cooking process. The word **"START"** disappears.

Meat probe cooking in progress

When meat probe cooking is in progress the display will show the oven cavity temperature at the top, the meat probe target temperature at the bottom and the full temperature bar on the right.



- Press the oven temp. knob to change the oven cavity and the meat probe target temperature as was done when setting the cooking cycle.
- Open the door to pause cooking. Close the door to resume cooking.
- Turn the oven mode knob to the left and then release it to stop the cooking cycle.

End of meat probe cooking

The meat probe cooking will end when the probe reaches the set target temperature. A buzzer will sound and the display will show:

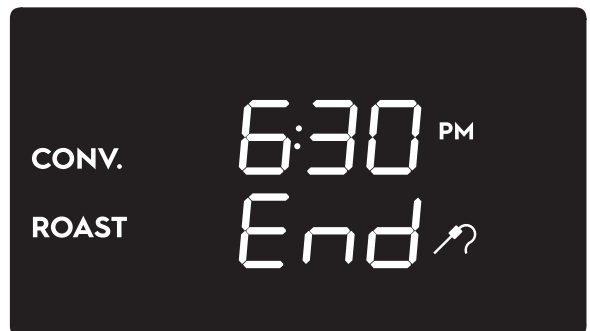

Turn and release the oven mode button to stop the buzzer and the function. The display goes into standby mode.

34 USING THE OVEN

Oven cooking tips

WARNING

FOOD POISONING HAZARD. Do not let food sit for more than one hour before or after cooking. Doing so can result in food poisoning or sickness. Foods that can easily spoil such as milk, eggs, fish, meat or poultry, should be chilled in the refrigerator first. Even when chilled, they should not stand in the oven for more than 1 hour before cooking begins and should be removed promptly once cooking has ended.

Air circulation in the oven

If using 1 rack, place it in center of oven. If using multiple racks, stagger cookware as shown in the following figures.

For optimum air circulation and best baking results, allow at least 2" around the cookware for proper air circulation and be sure pans and cookware are not touching each other, the oven door, the sides or the back of the oven cavity.

The hot air must circulate around the pans and cookware in the oven for even heat to reach around the food.

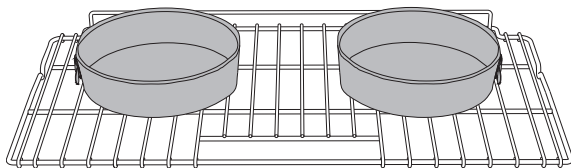

Pan position for one rack baking

NOTE

Always use caution when removing food from the oven.

When baking with two or more racks we recommend arranging the pans on the upper rack closer to the door and the pans on the lower rack closer to the fans (see the figure below).

Make sure that pans don't touch the internal glass pane of the door or the back wall of the oven.

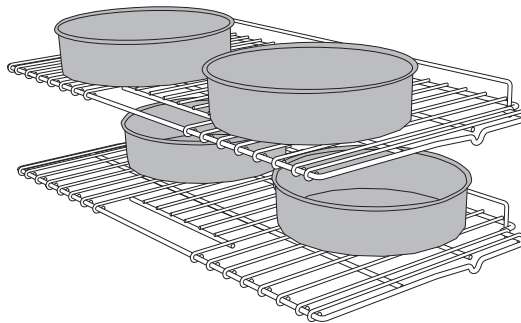

Pan position for four rack baking

Bake function tips

- Use the bake function to cook most food items that require normal cooking temperatures.
- As much as possible, use only one rack on position 2 or 3 and center the pans. If using two racks, place them in positions 1 and 4.
- Dark or dull pans absorb more heat than shiny bakeware resulting in dark or overbrowning of foods. It may be necessary to reduce the oven temperature or cook time to prevent overbrowning of some foods. Dark pans are recommended for pies. Shiny pans are recommended for cakes, cookies and muffins.
- Fully preheat the oven before baking items like cookies, cakes, biscuits and breads.
- Do not open oven door often. Opening the door will reduce the temperature in the oven and may increase the cook time.

Convection Bake function tips

- The Convection Bake function is optimized for multiple rack cooking.
- When baking cookies and biscuits on multiple racks, use positions 1 and 4. When baking cakes on multiple racks, use positions 1 and 3.
- Cookies and biscuits should be baked on pans with no sides or very low side to allow heated air to circulate around the food.
- Food baked on pans with a dark finish will cook faster.
- When placing multiple food items in the oven, allow at least 2" of space between them for proper air circulation.
- Use tested recipes with times adjusted for Convection Baking when using this mode. Check food at the minimum cooking time.

Broil function tips

WARNING

- Should an oven fire occur, close the oven door. If the fire continues, throw baking soda on the fire or use a fire extinguisher. Do not put water or flour on the fire. Flour may be explosive and water can cause a grease fire to spread and cause personal injury.
 - Use potholders or oven mitts when working with a hot oven.
 - Consuming raw or undercooked meats, poultry, seafood or shellfish may increase your risk of food borne illness.
- Use the Broil function to cook meats that require direct exposure to radiant heat for optimum browning results.
 - Always allow the oven to preheat before placing the food in it.
 - For proper broiling, use the broiler pan (1) and its insert (2) to place the meat on as shown in the figure below. The broiler pan insert contains slots that allow grease from the meat to drain into the broil pan.

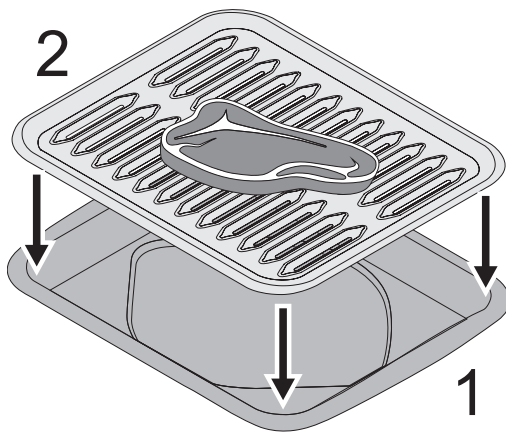

NOTE

The broiler pan and the insert are not included with the appliance.

- Broiling is direct heat cooking and will produce some smoke. If the smoke is excessive please refer to the "Oven problems" table.
- Broil one side until the food is browned; turn and cook the second side. Season and serve.

- Always pull the rack out to the "stop" position before turning or removing food (see "Regular rack").

Convection Roast function tips

- Convection roast combines a cook cycle with the convection fan and heating element to rapidly roast meats and poultry. Heated air circulates around the meat from all sides, sealing in juices and flavors. Meats cooked with this function are crispy brown on the outside while staying moist on the inside. In addition, there is no need to reduce the oven temperature when using convection roast.
- The Convection Roast function is optimized for multiple oven rack cooking.
- Place an oven rack in position 2 (next up from bottom).
- Please refer to the "Convection Roast function cooking table" for temperature and time instructions when cooking with this function.
- Do not cover foods when dry roasting - this will prevent the meat from browning properly.

Meat probe cooking tips

- For some foods, especially poultry and roasts, testing the internal temperature is the most effective way of insuring that your food has been properly cooked.
- For bone-in ham or lamb, insert the probe into the center of the lowest large muscle or joint. For dishes such as meat loaf or casseroles, insert the probe into the center of the food. When cooking fish, insert the probe just above the gill.
- For whole poultry or turkey, insert the probe into the thickest part of the inner thigh, below the leg.
- In general, place the temperature probe transversely in the thickest part of the food and for least 3/4 of its length.

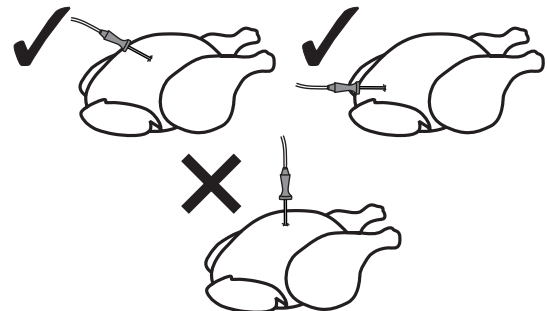

36 USING THE OVEN

- For very thick pieces of meat, take care to insert the entire length of the probe to ensure correct temperature detection.

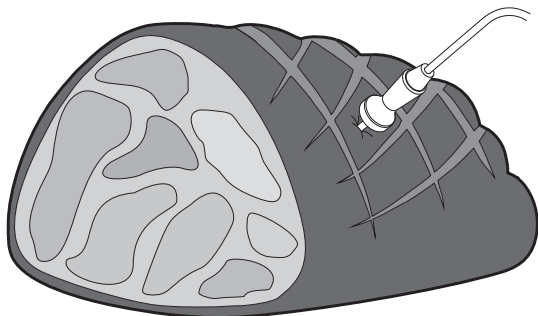

User settings menu

→ IMPORTANT

- To access the settings menu, you must first have to turn on the oven light and then press and hold the oven temperature knob for a few seconds.
- To exit from the settings menu, press and hold the temperature knob until the display goes into standby mode.

The user settings menu allows you to set the following parameters (displayed in this order):

1. Child lock mode:

The child lock mode allows you to lock the oven controls to prevent the appliance being activated unintentionally.

2. Demo mode:

This mode deactivates all the heating elements of the appliance, keeping the controls active. It is designed to simulate the operation of the appliance and is intended for exhibitors.

3. Temperature units:

This feature allows you to set the unit of measurement of temperature, degrees Celsius (°C) or degrees Fahrenheit (°F).

4. Time format:

This feature gives you the option to display the time in 12h format with AM/PM indication or 24h format.

Child lock mode

→ IMPORTANT

This setting will only lock the oven knobs.

After accessing the settings menu, the oven display will show:



By turning the temperature knob to right the screen will show



Press the knob to activate the child lock mode. The display will return to the standby screen.

ⓘ NOTE

When the child lock mode is active, the  icon appears on the right side of the display.

To deactivate the child lock mode, turn the temperature knob to the right. The display will show



and the  icon starts to flash. Now press the temperature knob for a few seconds to deactivate the child lock mode. The display will return to the standby screen.

Demo mode

➔ IMPORTANT

This mode can be activated and deactivated only for the first 5 minutes after the power to the appliance has been turned on.

After accessing the settings menu, keep pressing the temperature knob until the display shows:



By turning the temperature knob to right the screen will show:



Now keep pressing the temperature knob to exit from the settings menu.

The demo mode is now active and the range will operate normally with the difference that "5d" will always be displayed and no heat will be produced.

To deactivate the demo mode you have to disconnect and re-connect the appliance to the power supply and access the settings menu, disabling the parameter described above.

Temperature units

After accessing the settings menu keep pressing the temperature knob until the display shows



Turning the temperature knob to right causes the display to switch between °C and °F.



Press the knob to confirm the selection and exit from the user menu if you wish to do so.

Time format

After accessing the settings menu keep pressing the temperature knob until the display shows



By turning the temperature knob to the right, the display switches between the 12h (with the AM/PM indication) and the 24h time format



Press the knob to confirm the selection and to exit from the settings menu.

38 USING THE OVEN

Oven cooking tables

Bake function cooking table		
Food	Rack position	Recommended pan
Cookies	2	Shiny pan with no sides/ very low sides placed on the rack
Biscuits	3	Shiny pan with no sides/ very low sides placed on the rack

Convection Bake function cooking table		
Food	Rack position	Recommended pan
Cookies	1 - 4	Shiny pan with no sides/ very low sides placed on the rack
Biscuits	1 - 4	Shiny pan with no sides/ very low sides placed on the rack
White cake	1 - 3	8 inch diameter

Broil function cooking table					
Food	Rack position	Oven T°	Cooking time 1st side (min)	Cooking time 2nd side (min)	Doneness
Steak	4	550°F - 280°C	6	6	Med-Rare
	5	550°F - 280°C	6	4	Rare
Chicken Breast-bone in	4	450°F - 230°C	20	20	Well Done
Chicken Breast boneless	3	450°F - 230°C	30	10	Well Done
Fish Steak	4	500°F - 260°C	6	-	Well Done
Shrimp	3	550°F - 280°C	5	-	Well Done
Hamburger	5	550°F - 280°C	6	4	Med-Rare
	5	550°F - 280°C	8	5	Well Done

Convection Roast function cooking table					
Meat type	Weight (lb)	Oven T°	Probe T°	Time/lb (min/lb)	Rack position
Standing Rib Roast (med-rare)	5 - 7	350°F - 175°C	145°F - 60°C	15	2
Standing Rib Roast (well done)	5 - 7	350°F - 175°C	170°F - 75°C	24	2
Whole Ham, bone-in	10 - 15	325°F - 160°C	-	24	2
Whole Turkey	10 - 15	325°F - 160°C	-	12	2
Whole Turkey	15 - 20	325°F - 160°C	-	10	2
Whole Chicken	4 - 6	375°F - 190°C	180°F - 80°C	19	2
Pork Shoulder/Butt Roast	10 - 15	325°F - 160°C	180°F - 80°C	25	2
Pork Loin	4 - 6	350°F - 175°C	165°F - 70°C	25	2

*** In Convection Roast it is recommended to use the meat probe to reach the desired cooking level. Otherwise, refer to the Time/lb column.**

**** For lower meat weight it is suggested to decrease the Probe T° setting by 5°F. The cooking duration will decrease accordingly.**

40 CARE AND CLEANING

Steam clean function

CAUTION

- Remove any food residues or large spills from previous cooking operations from the inside of the oven.
- Only carry out this cleaning cycle when the oven is cold.
- In order to prevent burnings caused by hot steam it is strongly recommended to not open the door during the steam clean function.

IMPORTANT

- The temperature and the duration of this function are fixed and cannot be changed.
- The steam cleaning cycle lasts for 1 hour and can only be started when the inside temperature is below 167°F (75°C).

Before setting and starting the Steam cleaning cycle, completely remove all accessories from inside the oven.

To set the Steam Clean function (display in standby mode):

1. Press the oven mode knob.
2. Turn the oven mode knob until the Steam clean screen appears on the display:

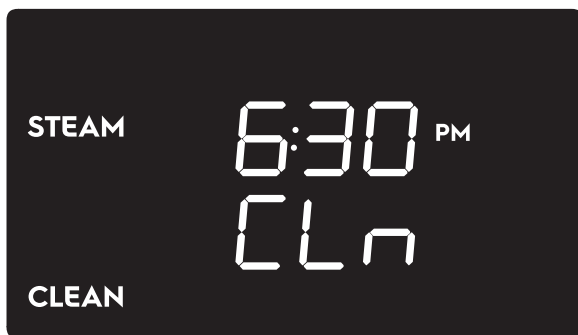

3. A delayed start can be set for this function by pressing the oven temp. knob until "DELAY" appears and then follow the instruction described in the "Delayed cooking" chapter.
6. Pour approximately 13.5 fl. oz. (400 cc - 1.7 cup) of water onto the bottom of the oven. Make

4. Press the oven mode knob.
 - If the inside temperature is above 167°F (75°C) the display shows:

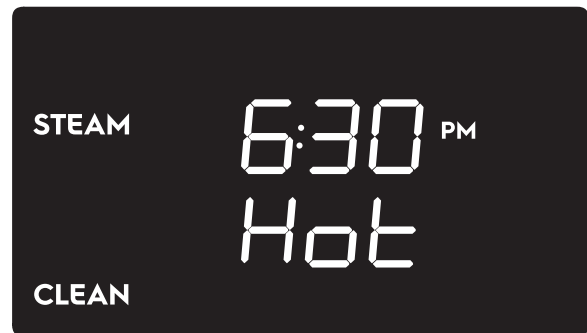

In this case the function cannot be started. Wait until the oven has cooled down.

- If the inside temperature is below 167°F (75°C) the display shows the following screen:

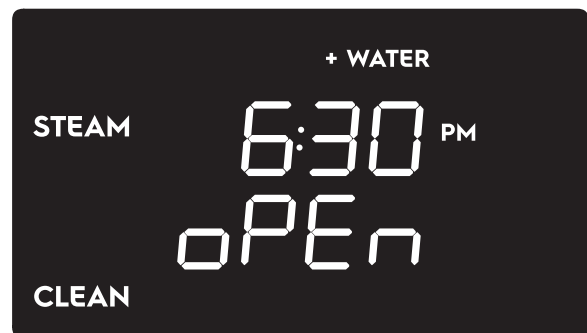

5. Open the oven door. The word "FILL" appears on the display to indicate that it is possible to pour water into the oven cavity.



sure it does not overflow out of the cavity.

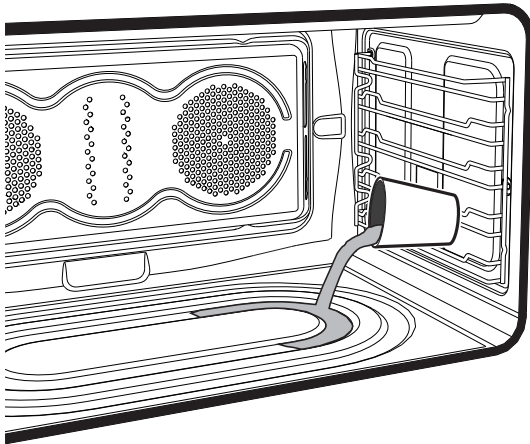

7. Close the oven door. The display now shows only the current time and the flashing word "START".
8. Press the oven mode knob to start the Steam Clean function.



End of Steam clean function

At the end of the cleaning cycle, a buzzer sounds and "END" will appear on the display together with the current time.

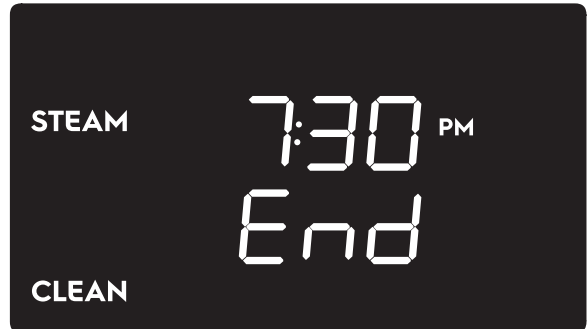

1. Turn and release the oven mode knob to the left to stop the buzzer, the display switches to the stand-by screen.
2. Open the door about 2" (5 cm) to let out most of the hot steam. Be very careful to keep distance while the hot steam comes out.
3. Open the door completely and wipe away the less stubborn dirt with a microfiber cloth. Use an anti-scratch sponge with brass filaments on tougher encrustations. In case of grease residues, use specific oven cleaning products.
4. Remove all the water left inside the oven and dry carefully.

For improved hygiene and to avoid food being affected by any unpleasant smells, we recommend that the oven is dried using the Convection Bake function at 320°F (160 °C) for approximately 10 minutes.

→ IMPORTANT

- We recommend wearing rubber gloves for these operations.

42 CARE AND CLEANING

Surface type	Cleaning recommendations
Aluminum & chrome surfaces (rear backguard and handle tips)	Use hot, soapy water and a cloth. Dry with a clean cloth.
Plastic & Zamak alloy (control knobs)	For general cleaning, use hot soapy water and a cloth. For more difficult to remove soil and built-up grease, apply a liquid detergent directly onto the soil. Leave for 30 to 60 minutes. Rinse with a damp cloth and dry. Do not use abrasive cleaners on any of these materials; they can scratch. To remove the control knobs, turn them to the OFF position; grasp firmly and pull straight off the shaft. To replace knobs after cleaning, line up the flat sides of both the knob and the shaft; then push the knob into place.
Stainless steel (all external trim pieces and control panel)	Clean stainless with warm soapy water using a clean sponge or cloth. Rinse with clean water and dry with a soft clean cloth. Do not use harsh cleaners. Only use kitchen cleaners that are especially made for cleaning Stainless Steel. Always be sure to rinse the cleaners from the surface as bluish stains may occur during heating that cannot be removed.
Porcelain enamel (oven cavity inside walls)	Gentle scouring with a soapy scouring pad will remove most spots. Rinse with a 1:1 solution of clear water and ammonia. If necessary, cover difficult spots with an ammonia-soaked paper towel for 30 to 40 minutes. Rinse with clean water and a damp cloth; then scrub with a soap-filled scouring pad. Rinse and wipe dry with a clean cloth. Remove all cleaners as the porcelain may become damaged when heated. Do not use spray oven cleaners on the cooktop.
Glass (door glasses and display glass)	Use soap & water to thoroughly clean the top, sides and front of the oven door. Rinse well. You may use a glass cleaner on the outside glass of the oven door. Do not immerse the door in water. Do not spray or allow water or the glass cleaner to enter the door vents. Do not use oven cleaners, cleaning powders or any harsh abrasive cleaning materials on the outside of the oven door.
Ceramic glass (induction cooktop surface)	See "Cleaning recommendations for the ceramic glass surface" for a detailed description.
Oven racks & shelves	Oven racks must be removed. Clean using a mild, abrasive cleaner following the manufacturer's instructions. Rinse with clean water and dry.

Oven maintenance

Removing the shelf supports

➔ IMPORTANT

This has to be done in order to replace the oven lights and enables you to clean the oven side walls.

- Grasp the shelf supports firmly by both ends to prevent scratching the enamel of the oven cavity when removing them.
- Wear protective gloves.

To remove the shelf supports:

1. Pull the frame towards the inside of the oven to unhook it from its groove **A**, then slide it out of the seats **B** at the back.

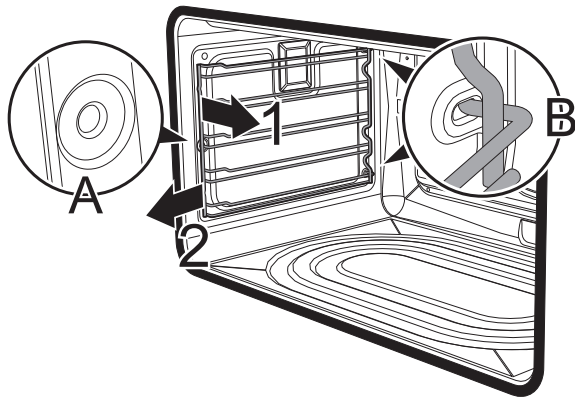

1. When cleaning is complete, repeat the above procedures to put the self supports back in.

Replacing the oven light



WARNING

ELECTRIC SHOCK HAZARD - Make sure the range is unplugged and that all parts are **COOL** before replacing oven light. Wear a leather-faced glove for protection against possible broken glass or burns.

➔ IMPORTANT

The oven is fitted with two 120V - 40W halogen light bulbs.

3. Close the cover. Ensure that the molded part of

The oven lights will automatically turn ON when the oven door is opened. The oven lights may also be manually operated by turning the oven temperature knob to the bulb icon (see "Inside lights").

The oven light bulb is covered by a glass shield. The glass shield can be removed to be cleaned manually or for replacing the oven light bulb. **THIS GLASS SHIELD MUST BE IN PLACE WHENEVER THE OVEN IS IN USE.**

To replace the oven lights:

1. Turn the power off at the main source or unplug the appliance.
2. Remove the bulb cover using a tool that cannot scratch the enamel surfaces (e.g. a spoon).

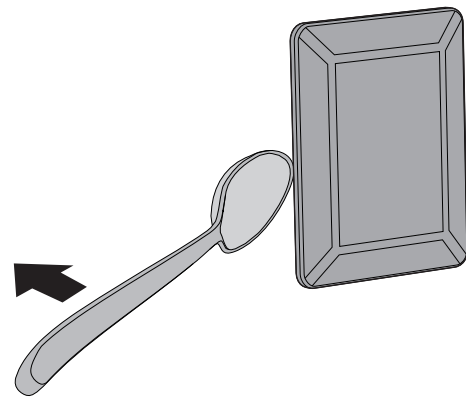

1. Slide out the light bulb and remove it

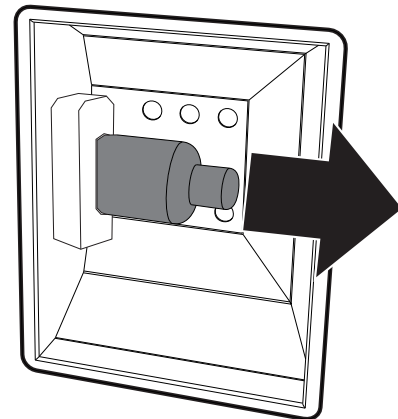

2. Install the new light bulb.

ⓘ NOTE

Do not allow your fingers to touch the new bulb when installing it. This will shorten the life of the new bulb. Use a paper towel to cover the new bulb when installing it.

44 CARE AND CLEANING

the glass (A) is facing the door.

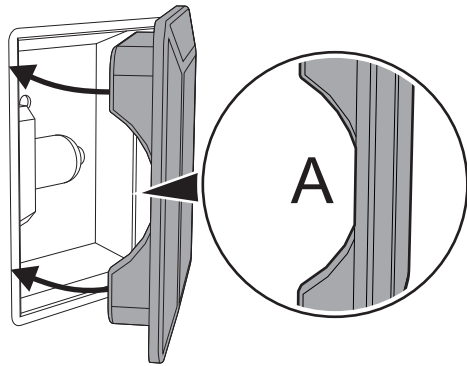

Special door care instructions

➔ IMPORTANT

Most oven doors contain glass that can break. Read the following recommendations:

- Do not close the oven door until all the interior oven racks are fully inserted and retracted to the back of the oven.
- Do not hit the glass with pots, pans, or any other object. The oven door glass may break or even break unexpectedly at a later time.
- Scratching, hitting, jarring or stressing the oven door glass may weaken its structure causing an increased risk of breakage at a later time.
- You may use a glass cleaner on the outside of the oven door glass. Do not spray or allow water or the cleaner to enter or drip down into the oven door vents. First spray cleaner onto the cloth and then wipe the oven door clean.
- Do not use strong oven cleaners, powders or harsh abrasive cleaning materials on the outside of the oven door or glass.

Removing the oven door

⚠ CAUTION

The oven door is heavy. Be careful when removing and lifting the door. Do not lift the oven door by the handle.

To remove the door proceed as follows:

1. Open the door completely and insert two pins into the holes on the hinges indicated in the figure:

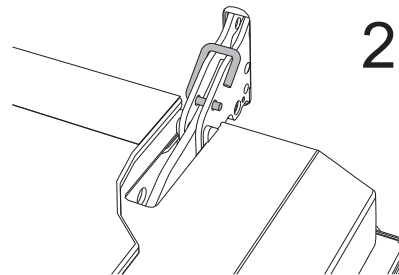
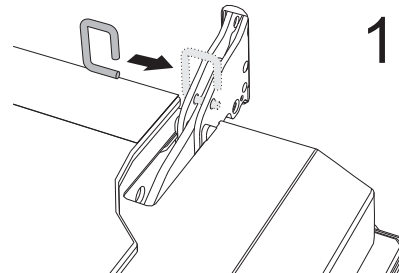

2. Grasp the door on both sides with both hands, lift it forming an angle of around 30° (1) and slide it out (2).

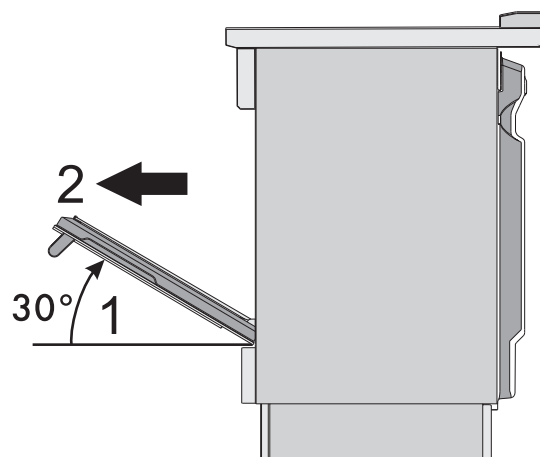

- To reassemble the door, put the hinges in the relevant slots in the oven, making sure that the grooved sections **A** are resting completely in the slots. Lower the door and once it is in place remove the pins from the holes in the hinges.

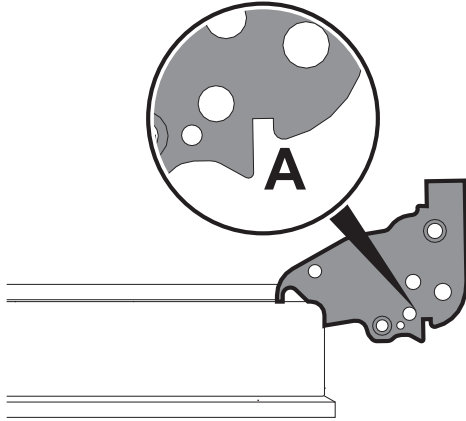

Removing the oven seal

To permit thorough cleaning of the oven, the door seal may be removed. There are fasteners on all 4 sides and in the middle to attach it to the edge of the oven. Pull the seal outwards at the indicated points in order to remove it from the appliance.

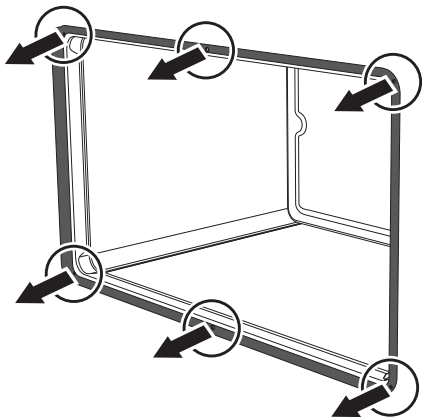

The seal should be soft and elastic. To clean the seal, use a non-abrasive sponge and wash with lukewarm water.

Removing the internal glass panes

For easier cleaning, the internal glass panes of the door can be disassembled:

- Remove the internal glass pane by pulling the rear part gently upwards, following the movement indicated by the arrows (1).

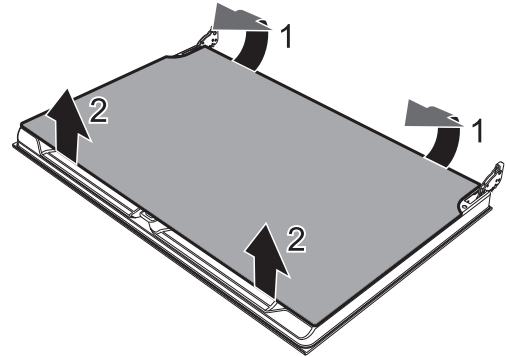

- Then pull the front part upwards (2). In this way, the 4 pins attached to the glass detach from their housings in the oven door.

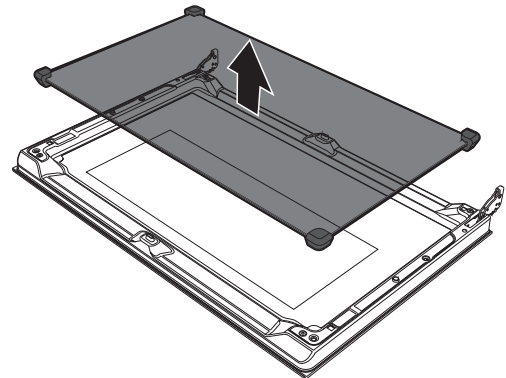

- Clean the external glass pane and the panes that were previously removed. Use absorbent kitchen roll. In case of stubborn dirt, wash with a damp sponge and neutral detergent.

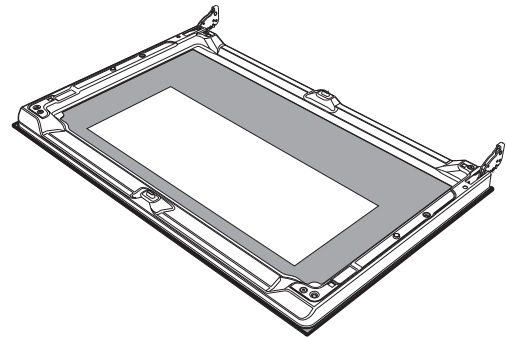

46 CARE AND CLEANING

4. Refit the panes in the reverse order in which they were removed. Reposition the internal glass pane. Take care to center and insert the 4 pins into their housings in the oven door by applying slight pressure.

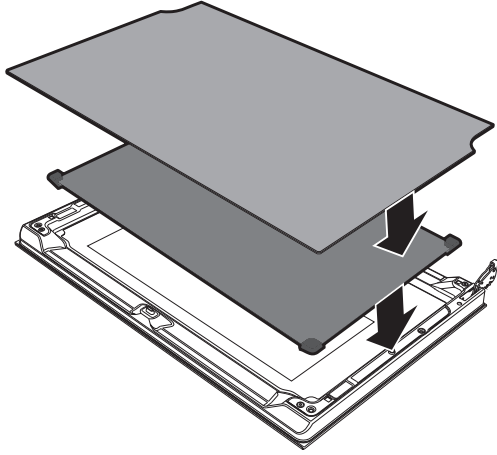

Cooktop cleaning and maintenance



WARNING

ELECTRIC SHOCK HAZARD - Disconnect the appliance from the power supply before carrying out cleaning.



WARNING

DO NOT use a cooktop cleaner on a hot cooktop. The fumes can be hazardous to your health and can chemically damage the ceramic-glass surface.



CAUTION

Before cleaning the cooktop, make sure the controls are turned to OFF and that the cooktop is COOL.

CONSISTENT AND PROPER CLEANING IS ESSENTIAL TO MAINTAINING YOUR CERAMIC GLASS COOKTOP.

- Do not use steam jets to clean the appliance.
- Do not use cleaning products containing chlorine, ammonia or bleach on steel parts or parts with metallic finishes on the surface (e.g. anodizing, nickel- or chromium-plating).
- Do not use abrasive or corrosive detergents on glass parts (e.g. powder products, stain removers and metallic sponges).

- Do not use rough or abrasive materials or sharp metal scrapers.
- Do not slide anything metal or glass across the cooktop.
- Do not use your cooktop as a cutting board or work surface in the kitchen.
- Do not cook foods directly on the cooktop surface without a pan.
- Do not drop heavy or hard objects on the glass cooktop, they may cause it to crack or break.

Cleaning recommendations for the ceramic glass surface

To maintain the surfaces, clean them regularly after each use once they have cooled down. Any marks left by the use of pans with aluminum bases can be wiped off with a damp cloth soaked in vinegar. If, after cooking, burnt residues remain, remove them with water and dry thoroughly with a clean cloth.

Grains of sand which may end up on the cooktop while cleaning lettuce or potatoes can scratch the cooktop when you move pans around.

Therefore, make sure that no grains of sand are left on the cooktop.

Changes in color do not affect the function and stability of the glass. It is not a question of changes to the cooktop material, but simply due to residues which were not removed and therefore charred.

Shiny spots can form due to the bases of pans rubbing on the surface, especially if they are aluminum, and the use of unsuitable cleaning agents. They are difficult to remove using common cleaning products. You may need to repeat the cleaning process several times. Using aggressive detergents or sliding the base of pans on the surface can, over time, wear away the decorations of the cooktop and could cause spots to form.

Regular daily cleaning

Always use only specific products that do not contain abrasives or chlorine-based acids. Pour the product onto a damp cloth and wipe the surface, rinse thoroughly and dry with a soft cloth or a microfiber cloth.

Weekly routine cleaning

Clean and maintain the cooktop once a week using a standard product for cleaning glass. Always follow the manufacturer's instructions. The silicone in these products creates a protective water- and dirt-repellent film. All the dirt remaining on the film can be removed easily. Just wipe the surface with a clean cloth. Make sure that no detergent remains on the cooktop surface because it will react aggressively when the cooktop is heated and can alter its structure.





Food stains or residues

Do not use metallic sponges or sharp scrapers as they will damage the surfaces. Use ordinary non-abrasive products with the aid of wooden or plastic utensils if necessary. Rinse thoroughly and dry with a soft cloth or a microfiber cloth. Do not allow residues of sugary foods (such as jam) to set inside the oven. If allowed to set for too long, sugar residue could pit the enamel lining of the oven.

48 BEFORE YOU CALL

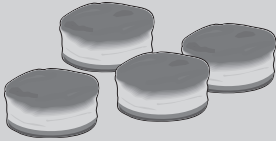
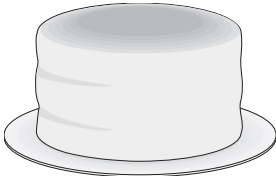
Baking problems

For best results, pre-heat the oven when baking cookies, breads, cakes, pies or pastries etc. There is no need to preheat the oven for roasting meats or baking casseroles. The cooking times and temperatures needed to bake a product may vary slightly from your previous appliance.

Problem	Causes	Corrections
Cookies and biscuits burn on the bottom 	<ul style="list-style-type: none"> • Cookies and biscuits placed in the oven before preheating has finished. • Oven rack overcrowded. • Dark pan absorbs heat too fast 	<p>Allow the oven to preheat to the selected temperature before placing food in it.</p> <p>See the "Air circulation in the oven" section.</p>
Cakes too dark on top or bottom 	<ul style="list-style-type: none"> • Cakes put into the oven before preheating has finished. • Rack position too high or low. • Oven too hot 	<p>Allow the oven to preheat to the selected temperature before placing food in it.</p> <p>Use proper rack position for baking needs.</p> <p>Set oven temperature 25°F/12°C lower than recommended.</p>
Cakes not done in the center 	<ul style="list-style-type: none"> • Oven too hot • Incorrect pan size. • Pan not centered in the oven. 	<p>Set oven temperature 25°F/12°C lower than recommended.</p> <p>Use pan size suggested in recipe.</p> <p>See the "Air circulation in the oven" section.</p>
Cakes not level 	<ul style="list-style-type: none"> • Range not level. • Pan too close to oven wall or rack overcrowded. • Pan warped. 	<p>Place a marked glass measuring cup filled with water on the center of the oven rack. If the water level is uneven, refer to the installation instructions for leveling the range.</p> <p>Be sure to allow 2" to 4" (5.1cm to 10.2cm) of clearance on all sides of each pan in the oven.</p> <p>Do not use pans that are dented or warped.</p>
Food not done when cooking time is up 	<ul style="list-style-type: none"> • Oven too cool. • Oven overcrowded. • Oven door opened too frequently. 	<p>Set oven temperature 25°F/12°C higher than suggested and bake for the recommended time.</p> <p>Be sure to remove all pans from the oven except the ones to be used for baking.</p> <p>Open oven door only after shortest recommended baking time.</p>

BEFORE YOU CALL 49

Let us help you troubleshoot your concern! This section will help you with common issues. If you need us, visit our website, chat with an agent, or call us. We may be able to help you avoid a service visit. If you do need service, we can get that started for you!

1-887-435-3287 (United States)
ElectroluxAppliances.com

1-800-265-8352 (Canada)
ElectroluxAppliances.ca

Oven problems	
Problem	Solution
Display shows an error code ("Err XX")	A fault has been detected. Record the fault code and call technical support.
Installation	Place the rack in the center of the oven. Place a level on the oven rack. Contact installing agent if rack and or cabinet are not level. Kitchen cabinet misalignment may make the range appear to be not level. Be sure cabinets are square and level. Contact the cabinetmaker to correct the problem.
Entire range does not operate	<p>Make sure the electrical cord is securely connected inside the electrical junction box.</p> <p>Cord/plug is not installed and/or connected. Cord is not supplied with the range. Contact your dealer, installing agent or authorized servicer.</p> <p>Service wiring not complete. Contact your dealer, installing agent or authorized servicer.</p> <p>Power outage. Check the house lights to be sure. Call your local electric company. Short in cord/plug. Replace cord/plug.</p> <p>Controls are not set properly. See instructions to set the controls.</p> <p>House fuse has blown or circuit breaker has tripped immediately following installation.</p> <p>House fuse may not be fully engaged. Check fuse and screw or engage circuit breaker securely.</p>
Oven lights do not work	Burned-out or loose bulb. Follow the instructions under Oven Light to replace or tighten the bulb.
Poor cooking results	<p>Many factors affect baking results. See "Oven cooking tips" for hints, cause and corrections.</p> <p>Adjust the recipe's recommended power levels or cooking times.</p> <p>Cookware is too lightweight or warped. Use heavier quality cookware so foods being prepared may cook more evenly.</p>
Fan noise when the appliance is off	This range is equipped with a cooling fan that runs during the cooking process to cool internal electronic components. It is normal for this fan to continue to run for an extended period of time, even when the oven is off.
Flames inside oven or smoking from oven vents	Excessive spillovers in oven. For example, this will happen for pie spillovers or large amounts of grease left on the oven bottom. Wipe up excessive spillovers before switching on the oven. If flames or excessive smoke are present see "Broil function tips" in the Setting Oven cooking tips section.

50 BEFORE YOU CALL

<p>Excessive oven smoke during broiling</p>	<p>Meat too close to the broiler element. Reposition the rack to provide more clearance between the meat and the broiler. Pour a small amount of water into the broiler pan before cooking to prevent meat grease from producing smoke due to intense heating. Do not let the water overflow from the pan. Meat not properly prepared. Remove excess fat from meat. Cut any remaining fatty edges to prevent curling but do not cut into the lean. Grid on broiler pan wrong side-up. Grease does not drain into broiler pan.</p> <p>Broiler pan used without grid or grid covered with aluminum foil. DO NOT use the broiler pan without the grid or cover the grid with aluminum foil.</p> <p>Oven needs to be cleaned. Grease has built up on oven surfaces. Regular cleaning is necessary when broiling frequently. Grease or food spatters cause excessive smoking.</p>
--	--

<p>Cooktop problems</p>	
<p>Problem</p>	<p>Solution</p>
<p>Cookware is too hot or not hot enough</p>	<p>Incorrect surface control setting. Adjust power level setting.</p>
<p>Cookware does not heat or does not heat evenly</p>	<p>Be sure the correct surface control knob is turned on for the cooking zone needed.</p> <p>Cookware is light weight or warped. Use only flat, evenly balanced, medium or heavyweight cookware. Flat pans heat better than warped pans. Cookware materials and weight of the material affect heating. Heavy and medium weight pans heat evenly. Because lightweight pans heat unevenly, foods may burn easily.</p>
<p>Control for power level setting not responding</p>	<p>Wait 5-6 seconds without any pressing the control to allow it to reset.</p>
<p>Areas of discoloration with metallic sheen on cooktop surface</p>	<p>Mineral deposits from water and food. Remove them and buff with a non-abrasive cloth or sponge.</p>
<p>Scratches or abrasions on cooktop surface</p>	<p>Coarse particles such as salt or hardened soils between cooktop and utensils can cause scratches. Be sure the cooktop surface and bottoms of utensils are clean before use. Small scratches do not affect cooking and will become less visible with time.</p> <p>Cleaning materials not recommended for ceramic-glass cooktop have been used.</p> <p>Cookware with a rough bottom was used. Use smooth, flat-bottomed cookware.</p>
<p>Metal marks on the cooktop</p>	<p>Sliding or scraping of metal utensils on cooktop surface. Do not slide metal utensils on the cooktop surface. Buff with a non-abrasive cloth or sponge. For more information, see "Cooktop cleaning and maintenance".</p>
<p>Brown streaks or specks on cooktop surface</p>	<p>Boil overs are cooked onto the surface. For more information see "Cooktop cleaning and maintenance".</p>

WARRANTY

Your appliance is covered by a one year limited warranty. For one year from your original date of purchase, Electrolux will pay all costs for repairing or replacing any parts of this appliance that prove to be defective in materials or workmanship when such appliance is installed, used and maintained in accordance with the provided instructions.

Exclusions

This warranty does not cover the following:

Products with original serial numbers that have been removed, altered or cannot be readily determined.

Product that has been transferred from its original owner to another party or removed outside the USA or Canada.

Rust on the interior or exterior of the unit.

Products purchased "as-is" are not covered by this warranty.

Food loss due to any refrigerator or freezer failures.

Products used in a commercial setting.

Service calls which do not involve malfunction or defects in materials or workmanship, or for appliances not in ordinary household use or used other than in accordance with the provided instructions.

Service calls to correct the installation of your appliance or to instruct you how to use your appliance.

Expenses for making the appliance accessible for servicing, such as removal of trim, cupboards, shelves, etc., which are not a part of the appliance when it is shipped from the factory.

Service calls to repair or replace appliance light bulbs, air filters, water filters, other consumables, or knobs, handles, or other cosmetic parts.

Surcharges including, but not limited to, any after hour, weekend, or holiday service calls, tolls, ferry trip charges, or mileage expense for service calls to remote areas, including the state of Alaska.

Damages to the finish of appliance or home incurred during installation, including but not limited to floors, cabinets, walls, etc.

Damages caused by: services performed by unauthorized service companies; use of parts other than genuine Electrolux parts or parts obtained from persons other than authorized service companies; or external causes such as abuse, misuse, inadequate power supply, accidents, fires, or acts of God.

DISCLAIMER OF IMPLIED WARRANTIES; LIMITATION OF REMEDIES

CUSTOMER'S SOLE AND EXCLUSIVE REMEDY UNDER THIS LIMITED WARRANTY SHALL BE PRODUCT REPAIR OR REPLACEMENT AS PROVIDED HEREIN. CLAIMS BASED ON IMPLIED WARRANTIES, INCLUDING WARRANTIES OF MERCHANTABILITY OR FITNESS FOR A PARTICULAR PURPOSE, ARE LIMITED TO ONE YEAR OR THE SHORTEST PERIOD ALLOWED BY LAW, BUT NOT LESS THAN ONE YEAR. ELECTROLUX SHALL NOT BE LIABLE FOR CONSEQUENTIAL OR INCIDENTAL DAMAGES SUCH AS PROPERTY DAMAGE AND INCIDENTAL EXPENSES RESULTING FROM ANY BREACH OF THIS WRITTEN LIMITED WARRANTY OR ANY IMPLIED WARRANTY. SOME STATES AND PROVINCES DO NOT ALLOW THE EXCLUSION OR LIMITATION OF INCIDENTAL OR CONSEQUENTIAL DAMAGES, OR LIMITATIONS ON THE DURATION OF IMPLIED WARRANTIES, SO THESE LIMITATIONS OR EXCLUSIONS MAY NOT APPLY TO YOU. THIS WRITTEN WARRANTY GIVES YOU SPECIFIC LEGAL RIGHTS. YOU MAY ALSO HAVE OTHER RIGHTS THAT VARY FROM STATE TO STATE.

If You Need Service

Keep your receipt, delivery slip, or some other appropriate payment record to establish the warranty period should service be required. If service is performed, it is in your best interest to obtain and keep all receipts. Service under this warranty must be obtained by contacting Electrolux at the addresses or phone numbers below.

This warranty only applies in the USA and Canada. In the USA, your appliance is warranted by Electrolux Major Appliances North America, a division of Electrolux Home Products, Inc. In Canada, your appliance is warranted by Electrolux Canada Corp. Electrolux authorizes no person to change or add to any obligations under this warranty. Obligations for service and parts under this warranty must be performed by Electrolux or an authorized service company. Product features or specifications as described or illustrated are subject to change without notice.

USA

1.877.435.3287

Electrolux
10200 David Taylor Drive
Charlotte, NC 28262



Electrolux

Canada

1.800.265.8352

Electrolux Canada Corp.
5855 Terry Fox Way
Mississauga, Ontario, Canada
L5V 3E4

914779578-E-502021