

# Dishwasher

---

## User manual

DW80DG55\*\*, DW80DG52\*\*, DW70H83YE\*\*

---



**SAMSUNG**

# Contents

---

<b>Safety information</b>	<b>4</b>
What you need to know about the safety instructions	4
Important safety symbols	4
Before using your dishwasher	7
<b>Before you start</b>	<b>8</b>
Unpacking your dishwasher	8
Checking parts	9
Unsuitable items for the dishwasher	11
<b>Using your dishwasher</b>	<b>12</b>
Basic use of racks	12
Detergent guidelines	19
Touchpad responsiveness	22
<b>Operations</b>	<b>23</b>
Control panel	23
Cycle overview	26
Simple steps to start your dishwasher	27
Settings	28
Special features	30
<b>Maintenance</b>	<b>31</b>
Cleaning	31
Long-term care	36
Storing your dishwasher	36

---

<b>Troubleshooting</b>	<b>37</b>
Check these solutions if your dishwasher...	37
Information codes	42
<b>Cycle chart</b>	<b>44</b>
<b>Appendix</b>	<b>46</b>
Helping the environment	46
Specifications	46
<b>Warranty (U.S.A)</b>	<b>47</b>
<b>Warranty (CANADA)</b>	<b>50</b>

# Safety information

---

Congratulations on your new Samsung dishwasher. This manual contains important information on the installation, use, and care of your appliance. Please take time to read this manual to take full advantage of your dishwasher's many benefits and features.

## What you need to know about the safety instructions

---

Warnings and Important Safety Instructions in this manual do not cover all possible conditions and situations that may occur. It is your responsibility to use common sense, caution, and care when installing, maintaining, and operating your dishwasher.

## Important safety symbols

---

What the icons and signs in this user manual mean:

### **WARNING**

Hazards or unsafe practices that may result in **severe personal injury or death**. To reduce the risk of fire, explosion, electric shock, or personal injury when using your dishwasher, follow these basic safety precautions:

### **CAUTION**

Hazards or unsafe practices that may result in **minor personal injury or property damage**.

### **NOTE**

These warning signs are here to prevent injury to you and others. Please follow them explicitly. After reading this section, keep it in a safe place for future reference.

# SAVE THESE INSTRUCTIONS

## California Proposition 65 Warning

 **WARNING:** Cancer and Reproductive Harm -  
[www.P65Warnings.ca.gov](http://www.P65Warnings.ca.gov).

### **WARNING**

When using your dishwasher, follow basic precautions, including the following:

1. Read all instructions before using the dishwasher.
2. Use the dishwasher only for its intended function.
3. Use only detergents or wetting agents recommended for use in a dishwasher and keep them out of the reach of children.
4. When loading items to be washed:
  - locate sharp items so that they are not likely to damage the door seal, and
  - load sharp knives with the handles up to reduce the risk of cut-type injuries.
5. Do not wash plastic items unless they are marked "dishwasher safe" or the equivalent. For plastic items not so marked, check the manufacturer's recommendations.
6. Do not touch the HEATING ELEMENT during or immediately after use.
7. Do not operate your dishwasher unless all ENCLOSURE panels are properly in place.
8. Do not tamper with the controls.
9. Do not abuse, sit on, or stand on the door or dish rack of the dishwasher.
10. To reduce the risk of injury, do not allow children to play in or on the dishwasher.
11. Under certain conditions, hydrogen gas may be produced in a hot-water system that has not been used for two weeks or more. HYDROGEN GAS IS EXPLOSIVE. If the hot-water system has not been used for such a period, before using the dishwasher turn on all hot-water faucets and let the water flow from each for several minutes. This will release any accumulated hydrogen gas. As the gas is flammable, do not smoke or use an open flame during this time.
12. Remove the door to the washing compartment when removing an old dishwasher from service or discarding it.

# SAVE THESE INSTRUCTIONS

# Safety information

---

## CAUTION

- After unpacking the dishwasher, keep the packaging out of the reach of children.
- The dishwasher is extremely heavy. Do not attempt to move or carry the dishwasher by yourself. Two or more people are needed to move a dishwasher and avoid potential injuries.
- As with any equipment using electricity, water, and moving parts, potential hazards exist.
- Do not install the dishwasher near electrical components. Keep the dishwasher away from open flames.
- Install and level your dishwasher on an uncarpeted floor that can support its weight.
- Your dishwasher must be properly grounded. Never connect it to an ungrounded outlet. See page 7 for more information on grounding your dishwasher.
- Connect the ground wire to the green ground connector in the terminal box.
- After the dishwasher is installed, check that the drain hose is properly connected and that there is no leakage from the hose connectors. If the drain hose is loose, it may cause property damage.
- The water supply line is susceptible to breakage. As time goes by, it becomes less flexible. Check the line periodically. If it is swollen, torn, cut, or there is a water leak, replace it immediately.
- To safely operate this appliance, familiarize yourself with its operations and exercise care when using it.
- Do not put gasoline, solvents, or other flammable materials inside the dishwasher. Do not wash dishes exposed to these materials.
- Keep your dishwasher detergent out of the reach of children. Detergent has an adverse effect on human organs. It contains elements for polishing and is corrosive. Avoid letting the detergent come into contact with your skin and eyes.
- Do not push or place pressure on the door when it is open, as this may damage the dishwasher or cause harm.
- Do not allow children to play in or on the dishwasher. They may harm themselves or damage the dishwasher.
- Disconnect the power cord (or set the circuit breaker to off) before servicing your dishwasher.
- Do not repair, replace, or service any part of your dishwasher yourself. Disassembly, repairs, and modifications are permitted by authorized service technicians only. Work done by an unauthorized person may void your warranty.

## SAVE THESE INSTRUCTIONS

- 
- Before disposing of your dishwasher, remove the door of the washing compartment or the door latch so that children or small animals cannot get trapped inside.
  - If the dishwasher is left unused for an extended period of time, turn off the water supply.
  - This dishwasher is intended for residential use only.

## Before using your dishwasher

---

### WARNING



#### Tip-Over Hazard

- Do not use the dishwasher until it is correctly installed.
- Do not push down on the dishwasher door when it is open.
- Do not place excessive weight on the dishwasher door when it is open.



#### Electric Shock Hazard

Failure to follow these instructions can result in death, fire, or electric shock:

- Electrically ground the dishwasher
- Connect the ground wire to the green ground connector in the junction box.
- Do not use an extension cord.

# SAVE THESE INSTRUCTIONS



# Before you start

---

Be sure to have your installer follow these instructions closely so that your new dishwasher works properly and that you're not at risk of injury when washing dishes.

Before you start

## Unpacking your dishwasher

---

- Once your new dishwasher has been delivered to you, carefully unpack it and check for any damage.  
If the dishwasher has been damaged, make note of it on the waybill and keep a copy. Do not install the dishwasher, and contact Samsung Customer Service at the number listed on the next page.
- If there is no damage to the product, you can proceed with the installation. If you are going to install it yourself, make sure to read through the installation guide and follow the directions inside.
- After unpacking your dishwasher, keep the packaging out of the reach of children to ensure their safety.



---

## Checking parts

---

When your dishwasher has been unpacked, make sure you've received all the parts shown below.

If your dishwasher was damaged during shipping, or if you do not have all the parts, contact **Samsung Customer Service at 1-800-SAMSUNG (726-7864)**.

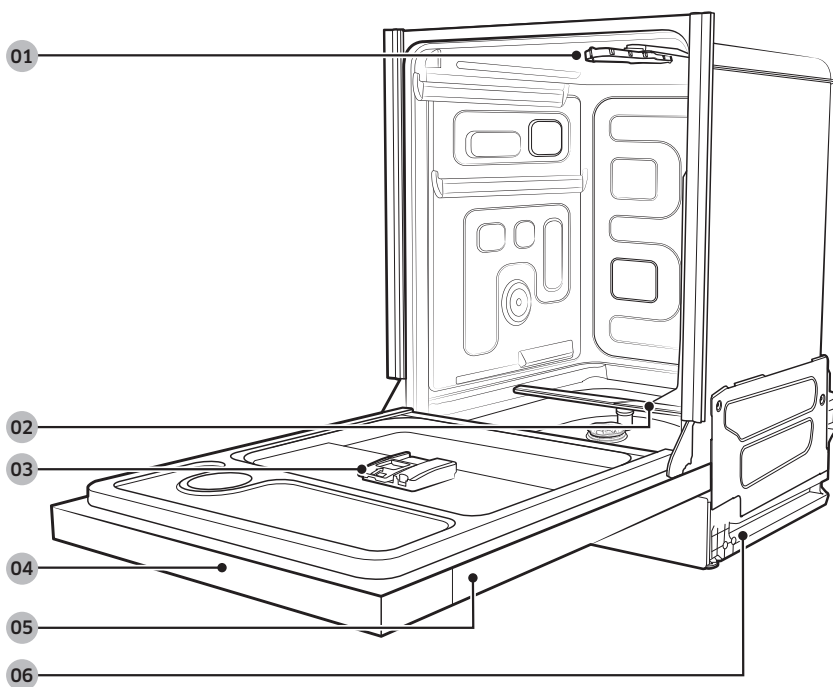

**01** Top nozzle

**02** Lower nozzle

**03** Dispenser

**04** Control panel

**05** Door

**06** Base

Before you start

# Before you start

## Accessories



Upper rack



Lower rack

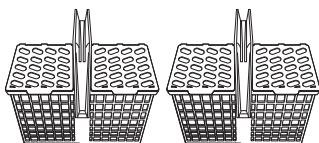

Cutlery rack (2)

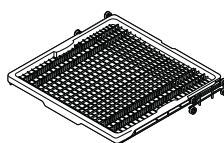

3<sup>rd</sup> rack (DW80DG55\*\*, DW70H83YE\*\* only)

Before you start

### CAUTION

- Do not wash items that are covered with ash, sand, wax, lubricating grease, or paint. These materials will damage the dishwasher. Ash does not dissolve and will spread inside the dishwasher.
- Remove food remains such as bones, fruit seeds, etc. and waste such as toothpicks, paper napkins, etc. from your dishes. Food remains and waste can make noise, cause the dishwasher to malfunction, and damage your dishes and dishwasher.

---

## Unsuitable items for the dishwasher

---

### **WARNING**

Wash only items such as glass, porcelain, and cutlery which the manufacturer states is dishwasher safe. Do not wash aluminium (for example grease filters). The dishwasher may damage aluminium, or in extreme cases, cause a severe chemical reaction.

**Do not wash the following items in the dishwasher.**

- Copper, brass, tin, ivory, and aluminium items or items with adhesive
- Non-heat resistant plastics
- Craft items, antiques, valuable vases, and decorative glassware
- Pottery or glazed-ceramic items
- Wooden cutlery and crockery or items with wooden parts. (Including silver & gold)
- Delicate glassware or glassware containing lead crystal. Clouding may occur on the glassware after frequent washing.
- Silver cutlery, crockery or items with silver parts.

### **NOTE**

Silverware that has contacted food containing sulphur may become discoloured. Food with sulphuric content include egg yolks, onions, mayonnaise, mustard, fish, fish brine, and marinades.

# Using your dishwasher

## Basic use of racks

### Adjusting the height of the upper rack

You can adjust the height of the upper rack in your Samsung dishwasher so that the lower rack can accommodate larger sized dishes. Depending on where you set the upper rack height, the lower rack can accommodate plates up to 14 in. (36 cm) in diameter and the upper rack can accommodate plates up to 12 in. (30 cm) in diameter.

#### DW80DG55 / DW80DG52 / DW70H83YE series

To adjust the height of the upper rack, follow these steps:

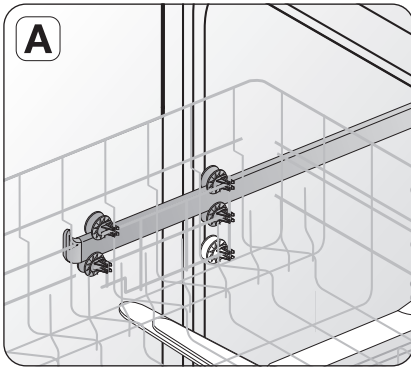

1. Remove the upper rack following the directions in **Removing the Upper Rack** below.
2. If you want to lower the upper rack, re-install the rack as shown in Figure A to the right.
3. If you want to raise the upper rack, re-install the rack as shown in Figure B to the right.

#### **⚠ CAUTION**

Recommended adjusting the height of the upper rack before loading dishes into the rack. If you adjust the the rack after loading the dishes, you may damage the dishes.

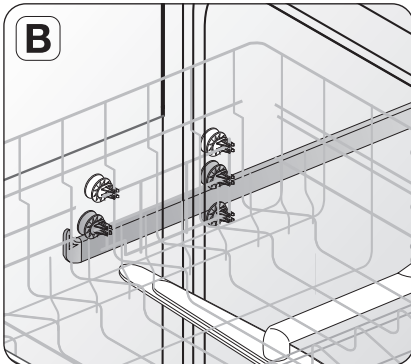

## Removing the upper rack

Pull the upper rack towards the front and then remove it by lifting it up slightly and pulling it towards the front. See the illustrations below.

### ⚠ CAUTION

While the upper rack is removable, it must be installed for the dishwasher to operate properly.

If you attempt to operate the dishwasher without the rack, noise will occur and the dishwasher will perform poorly.

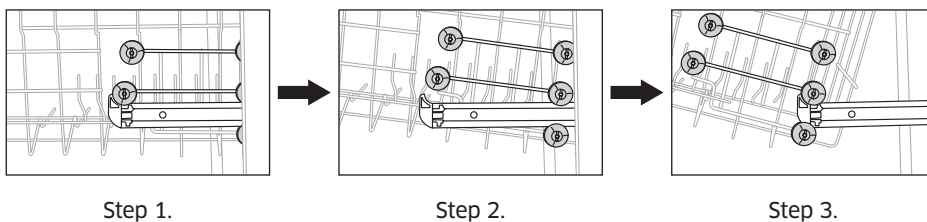

Step 1.

Step 2.

Step 3.

# Using your dishwasher

## Loading dishes

### Loading the lower rack

The lower rack has been especially designed for dinner dishes, soup bowls, plates, pots, lids, casserole dishes, and plates.

Load large items such as pans and pots into the dishwasher so their open sides face downwards. Recommended loading cups, stemware, and small plates into the upper rack. See the recommended loading patterns below.

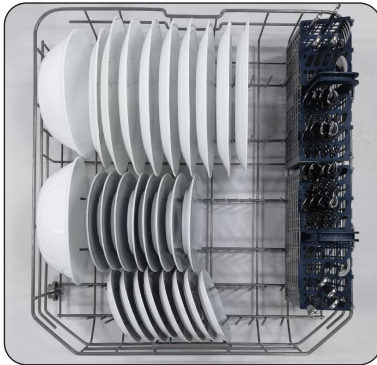

8 place settings

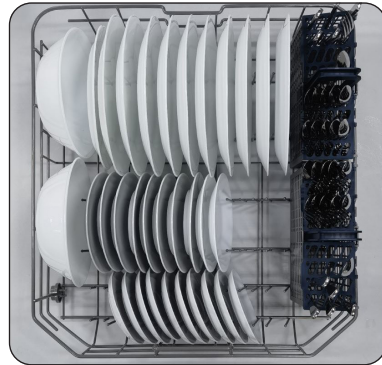

10 place settings

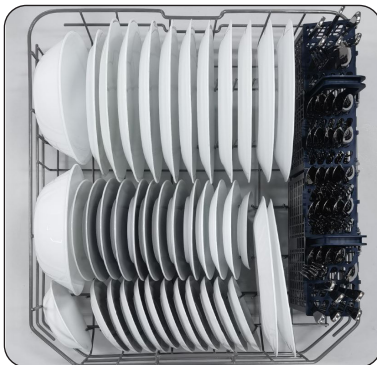

12 place settings



### Loading the upper rack

The upper rack has been designed for small plates, mugs, glasses, and plastic items marked "dishwasher safe". Load your plates into the dishwasher in two half rows, so that the front of each plate faces the back of the plate in front of it, and the open sides of the plates at the center of the dishwasher face each other. See the illustrations below.

Make sure the loaded dishes do not interfere with the rotation of the nozzle which is located at the bottom of the upper rack. (Check this by rotating the nozzle by hand.)

When loading dishes, pull the upper rack out sufficiently so you can load it without striking the counter above.

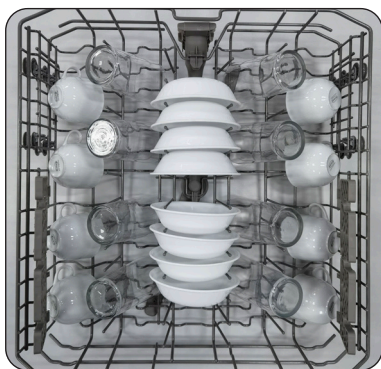

8 place settings

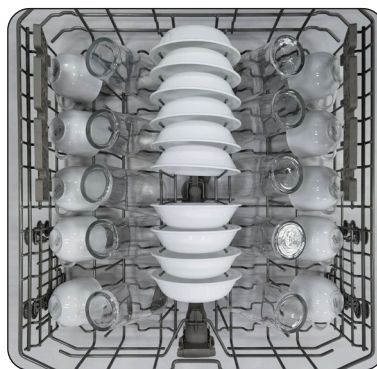

10 place settings

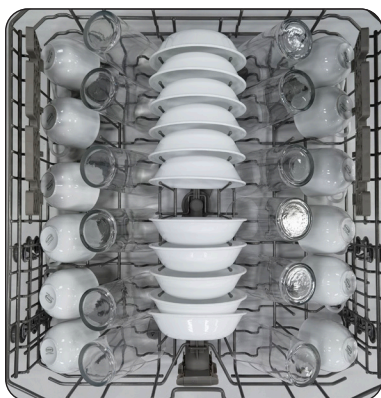

12 place settings

Using your dishwasher





# Using your dishwasher

## Using the glass support

The glass support is used for cups, small items, and long cookware, and especially suited for wine glasses. Hang wine glasses onto the pegs of the cup shelves. Fold the glass support back when it is not being used.

### CAUTION

- Do not adjust the level of the upper rack with the glass support propped up. This will make it impossible to push the glass support in the upper rack.
- Check whether cups are interfering with the 3<sup>rd</sup> rack when pushing in the upper rack after loading cups onto the glass support. Cups may be damaged or displaced.

## Loading the 3<sup>rd</sup> Rack (applicable models only)

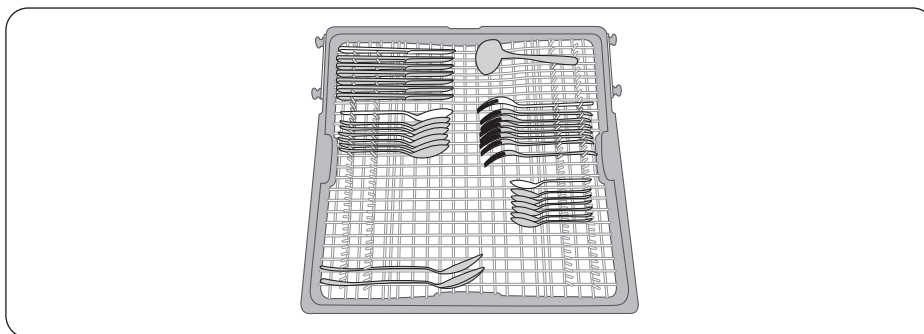

The 3<sup>rd</sup> rack is best suited for flatware and cooking or serving utensils. Use it with the spoon stands in the lower basket. You can load cutlery and utensils in the 3<sup>rd</sup> rack or the spoon stands in the lower basket.

## Removing the 3<sup>rd</sup> rack

The entire cutlery rack can be removed if more space is needed on the upper rack for larger items.

\* When loading the cutlery and utensils onto the cutlery rack, make sure they do not interfere with the top nozzle of the rack. If they interfere, remove the cutlery pad and try again.





## Loading the Cutlery rack

The cutlery rack consists of two compartments.

You can place each knife, spoon, or fork separately into the spoon stands in the basket's covers to prevent chipping and discoloration. See the illustrations below.

You can use the cutlery rack with the cover open. Refer to the illustration on the left.



Left



Right

8 place settings



Left



Right

10 place settings



Left



Right

12 place settings



# Using your dishwasher

The spoon stands as seen from above with the suggested placement of cutlery items. Match the numbers in the diagram to the numbers in the list of cutlery items below.

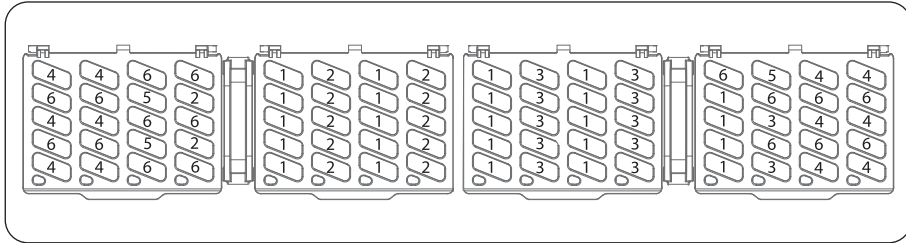

Using your dishwasher

**NOTE**

Do NOT let any item extend through the bottom. Do not load chopsticks in this rack. Chopsticks should be loaded on the 3<sup>rd</sup> rack.

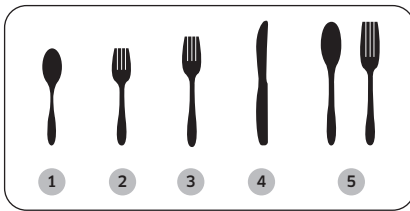

1. Tea spoons
2. Salad forks
3. Dinner forks
4. Knives
5. Serving spoons and Serving forks
6. Remaining items

## Detergent guidelines

All dishwasher cycles require detergent in the detergent compartment. Apply detergent as appropriate for the selected cycle to ensure best performance.

### ⚠ WARNING

- Do not consume dishwasher detergent. Avoid breathing in detergent fumes. Dishwasher detergent contains irritants and caustic chemicals that can induce respiratory conditions. If you have consumed dishwasher detergent or inhaled detergent fumes, seek medical attention immediately.
- Keep dishwasher detergent out of children's reach.

### ⚠ CAUTION

Use dishwasher detergent only. Other types of detergent produce excessive foam, which may decrease the dishwasher's performance or cause it to malfunction.

### Filling the detergent dispenser

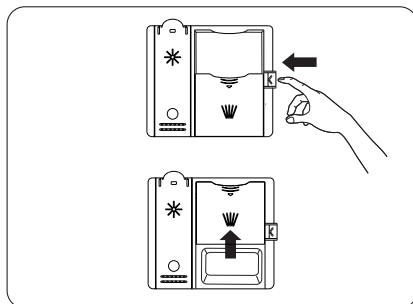

1. Open the detergent dispenser flap by pushing the detergent dispenser release button.

### 📄 NOTE

The flap is always open at the end of a washing cycle.

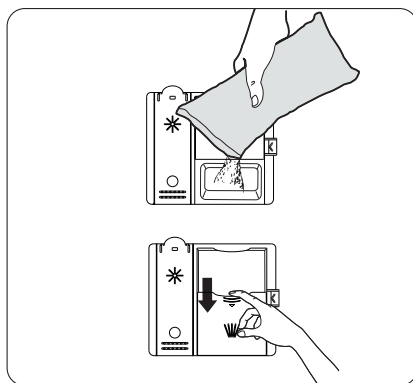

2. Add the recommended amount of detergent to the main wash detergent compartment.
3. Close the flap by pressing it down.

# Using your dishwasher

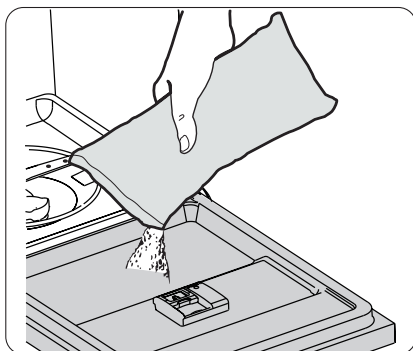

4. For better cleaning result, pour a small amount (about 15 g) of detergent onto the door. The additional detergent will be used during the pre-wash phase.

The cover opens automatically to dispense the detergent during the wash.

Cycle	Amount of detergent	
	Main wash dispenser	Onto the door for pre-wash
Auto, Normal	3/4 oz (20 g)	1/3 oz (10 g)
Heavy, Express 60'	1 oz (30 g)	1/2 oz (15 g)
Delicate	3/4 oz (20 g)	1/5 oz (5 g)

## NOTE

The numbers inside the dispenser refer to grams.

## Rinse aid

Rinse aid improves the drying performance of the dishwasher. When the Rinse Refill indicator lights up on the control panel, refill with rinse aid. Only use liquid rinse aid. Powdered rinse aid will clog the compartment opening and cause the dishwasher to malfunction.

## CAUTION

- Do not apply any type of detergent to the rinse aid compartment.
- Do not over fill the compartment. Excessive rinse aid may overflow during a cycle.

## Filling the rinse aid reservoir

Your dishwasher has been designed to use liquid rinse aid only.

Using a powdered rinse aid will clog the reservoir opening and cause the dishwasher to malfunction. Rinse aid improves the drying performance of the dishwasher.

### ⚠ CAUTION

Do not add regular detergent to the rinse aid reservoir.

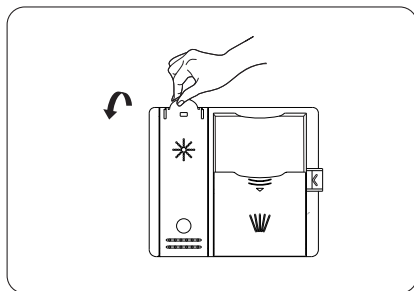

1. Open the rinse aid reservoir cap.

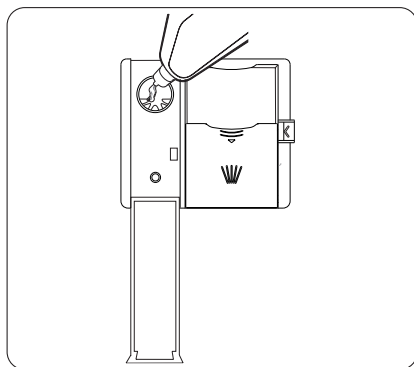

2. Fill the rinse aid reservoir with rinse aid.

### 📖 NOTE

Use the viewing port when filling the rinse aid reservoir.

### ⚠ CAUTION

- Do not fill the reservoir above the full level indicator.
- Excess rinse aid can overflow during the wash cycle.

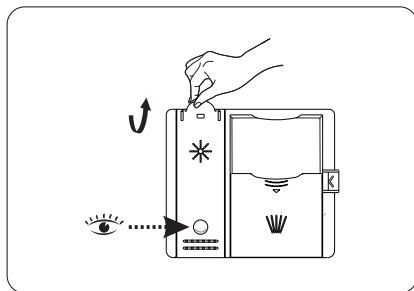

3. View the amount of rinse aid in the reservoir through the clear viewing port. Stop adding when the reservoir reaches the full level.
4. Close the rinse aid reservoir cap.

# Using your dishwasher

## Touchpad responsiveness

To prevent the touch-enabled controls from losing responsiveness, follow these instructions.

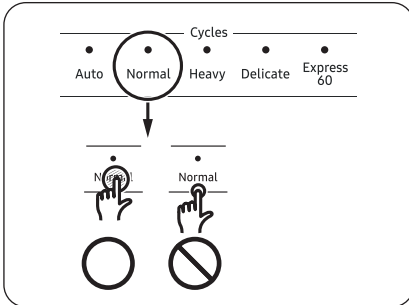

- Touch the center of each button with one finger.
- Do not touch more than one button at a time, except as directed.
- Clean the surface of the control panel regularly with a soft, damp cloth.

# Operations

## WARNING

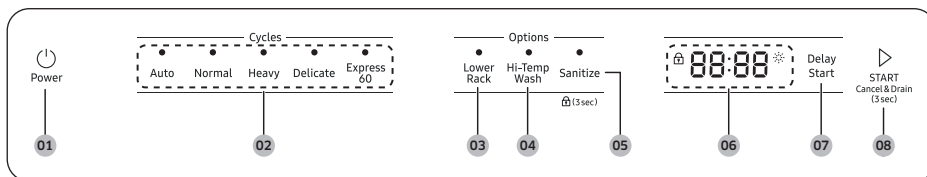

To reduce the risk of fire, electric shock, or injury to persons, read the IMPORTANT SAFETY INSTRUCTIONS before operating this appliance.

## Control panel



<b>01</b> Power	When you press the <b>Power</b> button, the Cycle On light for the most recently started cycle turns on. When the selected cycle is complete, the dishwasher powers off automatically.
<b>02</b> Cycle Selector	Select the appropriate wash cycle depending on the soil level of your dishes. After you select a cycle, the Cycle On light for that cycle lights. If you want to change the cycle once it has started, press the <b>Power</b> button. Then, turn on the dishwasher again and select a new cycle.
<b>03</b> Lower Rack	If selected, only the lower rack nozzle is activated to reduce both the cycle time and power consumption. Use this cycle to wash a small load of dishes or glasses in the lower rack.
<b>04</b> Hi-Temp Wash	Raises the main wash temperature to improve cleaning for loads containing tough, baked-on food.  <b>NOTE</b> Hi-Temp Wash is not available for the Delicate cycle.

# Operations

<p><b>05</b> Sanitize / Control Lock </p>	<p>With the <b>Sanitize</b> option selected, the water temperature is increased to 163 °F (73 °C) in the final rinse cycle for high temperature sanitization.</p> <p>If you select the <b>Sanitize</b> option, the "Sanitize" lamp blinks when the water temperature reaches the sanitary temperature (over 157 °F (69 °C)), and then remains illuminated until the <b>Sanitize</b> option ends.</p> <p>When you open the door or press the <b>Power</b> button, the "Sanitize" lamp turns off.</p> <p>Control Lock allows you to lock the buttons on the control panel so children cannot accidentally start the dishwasher by pressing the buttons on the panel.</p> <p>To lock and unlock the buttons on the control panel, press and hold <b>Sanitize</b> for 3 seconds when the power is on.</p> <p> <b>NOTE</b></p> <p><b>Sanitize</b> is not available for the <b>Delicate</b> cycle.</p> <p>Only <b>Normal</b> cycle with the <b>Sanitize</b> option has been designed to meet the requirements for soil removal and sanitization efficacy in NSF 184. Certified residential dishwashers are not intended for licensed food establishments.</p> <p>For the Sanitize mode, the amount of detergent as <math>\frac{3}{4}</math> oz (20 g) in Main wash dispenser and <math>\frac{1}{3}</math> oz (10 g) on the door for pre-wash is used.</p>
<p><b>06</b> Display</p>	<p>Displays information about the current cycle including the cycle time, remaining time, Delay Start settings, and other cycle-specific information.</p> <p>If a problem occurs during operation, an information code will appear with a warning sound. Refer to the information codes on page 42.</p>
<p><b>07</b> Delay Start</p>	<p>Delay a cycle for up to 24 hours in one-hour increments. To increase the delay start time, press or hold the <b>Delay Start</b> button. The hour displayed indicates the time at which the wash will start.</p> <ul style="list-style-type: none"> <li>- After setting the delay time, press the <b>Start</b> button, and then close the door to start the cycle.</li> <li>- To change the delay time after the dishwasher has started, first turn the dishwasher off and turn it back on. Then, select a new cycle and change the delay time settings.</li> </ul>



## 08 Start

To start a cycle, press the **Start** button before closing the door.  
**Cancel & Drain:** To cancel a currently running cycle and drain the dishwasher, press and hold the **Start** button for three (3) seconds. Once the dishwasher is reset, select a cycle and option, and then press **Start** to restart the dishwasher.

## Indicators



Delay Start

Control Lock indicator		Lights up if Control Lock is activated, and blinks if any button except for the <b>Power</b> button is pressed.
Rinse Refill indicator		Lights up if the dishwasher runs out of rinse aid.

# Operations

## Cycle overview

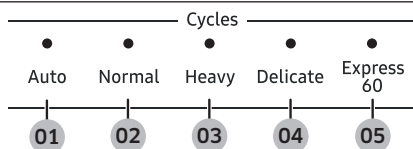

<b>01</b> Auto	This cycle detects the level of soil and automatically initiates the optimal cycle after a few minutes of operation.
<b>02</b> Normal	Use this cycle for normally soiled dishes. The energy-usage label is based on this cycle.
<b>03</b> Heavy	Use this cycle for heavily soiled dishes.
<b>04</b> Delicate	Use this cycle for soiled, fragile items such as fine glassware and crystal glass (wine glass). Do not use this cycle for other glassware because clouding or etching may occur.
<b>05</b> Express 60'	Use this cycle when you need to wash dishes quickly. It takes about 1 hour.

---

## Simple steps to start your dishwasher

---

1. Open the door, and then load the dishwasher. Make sure dishes are empty.
2. Place dishes into the upper and lower racks, unless you have selected Lower Rack.
3. Add detergent to the detergent dispenser. For better results, add rinse aid to the rinse aid compartment.

 **NOTE**

You should use rinse aid for better drying performance. You can further improve drying performance by also selecting the **Sanitize** option.

4. Press **Power**, and then select a cycle with necessary options (Lower Rack, Hi-Temp Wash, Sanitize).  
If you change the cycle after selecting an option, the option is released.
5. Press **Start**, and then close the door within 3 seconds. The dishwasher starts the cycle after draining for a few seconds.

 **NOTE**

- To change the cycle after it has started, press and hold **Start** for 3 seconds to cancel the cycle. Then, select a new cycle.
- To resume after you have opened the door to stop the dishwasher while operating, simply press **Start** first, then close the door.

# Operations

## Settings

You can change the Sound, Rinse aid amount, and Auto Release™ Dry settings to your preference. To change the settings, press the **Sanitize** and **Delay Start** buttons simultaneously for 3 seconds. Press **Sanitize** to navigate through the sub menus, and then press **Delay Start** to confirm your changes.

Sound > Rinse aid amount > Auto Release™ Dry  
U1/U0 F1~F5 A1/A0

After setting is finished, press **Power** button or **Sanitize** and **Delay Start** buttons.

### Sound

Press **Sanitize** repeatedly until 'U1' or 'U0' is displayed. To mute the dishwasher, select 'U0', and then press **Delay Start**. To unmute, select 'U1', and then press **Delay Start**.

The factory default level is 'U1'.

### Rinse aid amount

Press **Sanitize** until 'F1~F5' is displayed. The higher the number, the more rinse aid the dishwasher uses. To improve drying performance, select a higher number.

If your dishes appear discolored after a wash, switch to a lower number.

The factory default level is 'F4'.

## Auto Release™ Dry

The Auto Release™ Dry function, which is designed to improve drying performance, automatically opens the dishwasher's door 1 to 15 minutes before a cycle ends.

You can enable or disable Auto Release™ Dry by using the Setting Mode which is described as shown below.

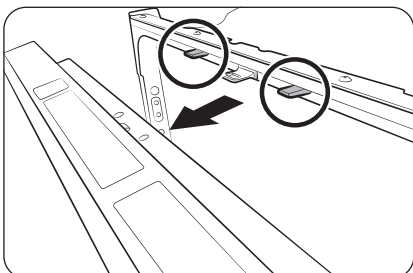

Press **Sanitize** until 'A1' or 'A0' is displayed. Then, press **Delay Start** to enable (A1) or disable (A0) Auto Release™ Dry. The factory default level is 'A1'.

### NOTE

- Once the door opens on the Auto Release™ Dry mode, the door cannot be closed manually for the next 2 minutes.
- Disabling (A0) "Auto Release™ Dry" can affect the drying results. Enable (A1) "Auto Release™ Dry" for better drying result.
- After a cycle is complete, the door automatically opens to let steam out. This is normal and not a product malfunction.



# Operations

---

## Special features

---

### Delay Start

You can delay the cycle starting time up to 24 hours in 1-hour increments. To increase the delay time, press **Delay Start**. The hour displayed indicates the time at which the cycle will start.

1. Open the door, and then load the dishwasher.
2. Press **Delay Start**, and then press or hold **Delay Start** to change the time in 1-hour increments.
3. Close the door, and then press **Start**.

#### **NOTE**

To change the delay time once the dishwasher has started, press **Power** and then restart the dishwasher.

### Touch Controls

Touch controls allow you to operate the dishwasher easily.

- They are convenient to operate, requiring only a soft touch.
- Have a simple and stylish design.
- Are easy to clean.

#### **NOTE**

If you have children or you want to clean the Control Interface, recommended activating the Control Lock feature to lock the control buttons.

### Control Lock

To prevent children from playing with the dishwasher, Control Lock locks all button controls except for **Power**.

- To activate Control Lock, press and hold **Sanitize** for 3 seconds. With Control Lock activated, you cannot select a cycle or option, or start an operation.
- To deactivate Control Lock, press and hold **Sanitize** again for 3 seconds.
- Control Lock remains active after the dishwasher restarts. To cancel Control Lock, you must deactivate it first.



# Maintenance

---

## Cleaning

---

Keep the dishwasher clean to improve performance, reduce unnecessary repairs, and lengthen its lifecycle.

### Exterior

Clean spills on the surface of the dishwasher as they occur. Use a soft, damp cloth on the control panel to gently wipe away spills and dust.

#### CAUTION

- Do not use benzene, wax, thinner, chlorine bleach, alcohol, or other chemical substances. These materials may discolour the surface of the dishwasher and cause stains.
- The dishwasher has electric parts inside. Do not sprinkle water directly onto the dishwasher. Protect electrical components from coming in contact with water.
- For a stainless-steel door panel, clean using a stainless steel cleaner for home appliances and a clean, soft cloth.

### Interior

Clean the interior of the dishwasher on a regular basis to remove any dirt or food particles. Wipe inside the dishwasher and inside the door with a wet dishcloth.

To keep the cutlery pad clean, turn it over after each use. To remove white spots and odors from the cutlery pad, run the Normal cycle with the dishwasher empty and no detergent until the cutlery pad flushes. Then, stop the cycle and put an 8-ounce cup of white vinegar into the lower basket. Close the door, and then resume the cycle.

Use a damp cloth to remove lime scale or grease deposits inside the dishwasher. Alternatively, apply some detergent, and then run an empty cycle using the highest rinse temperature.

#### CAUTION

- Do not remove the front seal (the long rubber seal enclosing the opening of the dishwasher). The seal keeps the inner side of the dishwasher sealed.

# Maintenance

## Nozzles

To prevent the nozzles from being clogged or if the nozzles are clogged, remove and clean each nozzle. Use caution when removing the nozzles as they may break.

### Top nozzle

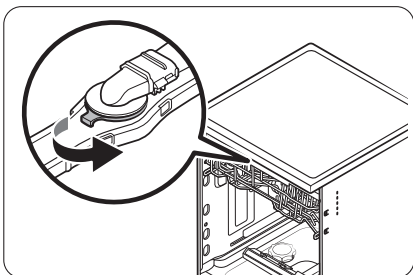

1. Open the door, then pull out the upper rack. The top nozzle is visible on the top.
2. Turn counter clockwise and remove the **nozzle cap**, then remove the nozzle.
3. Unclog and clean the nozzle.
4. Reinsert the nozzle, then tighten the cap clockwise.
5. Rotate the nozzle by hand to make sure the nozzle is engaged correctly.

### Upper nozzle

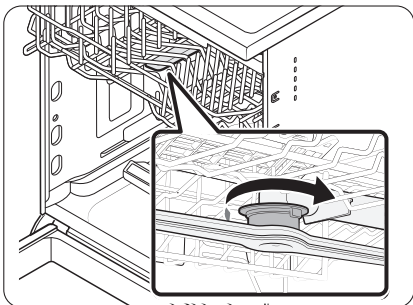

1. Open the door, then pull out the upper rack to reveal the upper nozzle.
2. Loosen and remove the nut, then remove the nozzle.
3. Unclog and clean the nozzle.
4. Reinsert the nozzle, then tighten the nut by hand.
5. Rotate the nozzle by hand to make sure the nozzle is engaged correctly.

## Lower nozzle

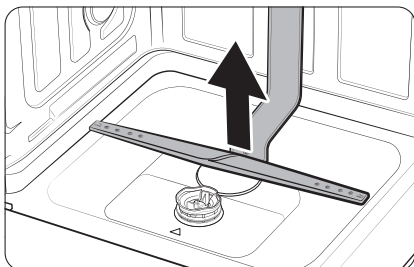

1. Open the door, then pull out the lower rack. The lower nozzle is visible on the bottom.
2. Unclog and clean the nozzle.
3. Reinsert the nozzle.
4. Rotate the nozzle by hand to make sure the nozzle is engaged correctly.

## Filter

Recommended cleaning the filter every month.

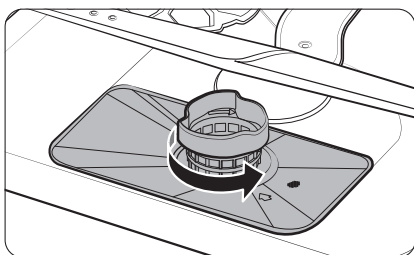

1. Open the door, then remove the lower rack first.
2. Turn the filter handle counterclockwise to unlock the Coarse filter.

# Maintenance

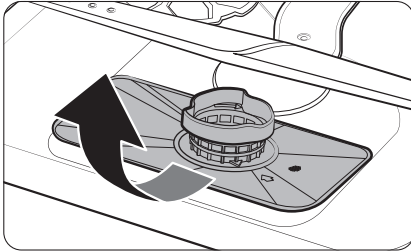

3. Remove the Coarse filter, then the cylindrical micro filter underneath.

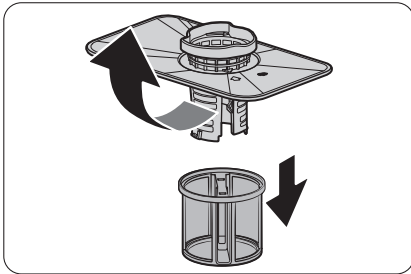

4. Remove any dirt and impurities from the micro filter and the Coarse filter.
5. Rinse both filters with running water, and then dry well.

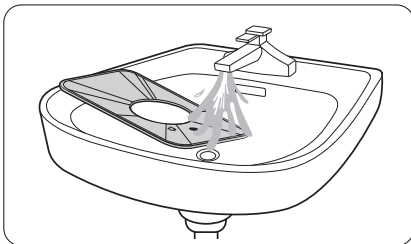
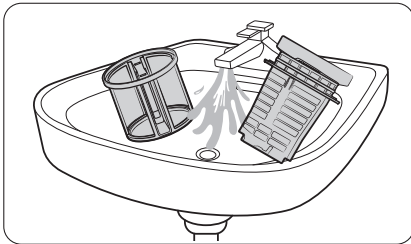

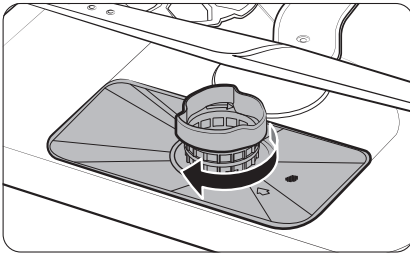

6. Reinsert the filter, and then the Coarse filter.
7. Turn the filter handle clockwise to lock.

**⚠ CAUTION**

Make sure the Coarse filter is closed properly. A loose cover can reduce the filtering performance.

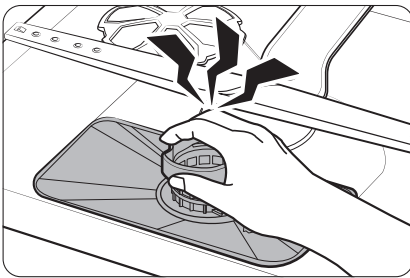

**⚠ CAUTION**

When removing the filter, the hand can be caught between the rotor and filter.

# Maintenance

---

## Long-term care

---

If you are not using the dishwasher for an extended period of time, first drain the unit completely, and then disconnect the water hose. Shut off the water supply valve and the circuit breaker. Water remaining in the hoses or the internal components can damage the dishwasher.

## Storing your dishwasher

---

If you need to store your dishwasher for an extended period of time, first drain and disconnect it. If water remains in the hoses and internal components, you can damage the dishwasher.

After draining and disconnecting the dishwasher, be sure to turn off the water supply valve and circuit breaker.

# Troubleshooting

## Check these solutions if your dishwasher...

Problem	Possible cause	Solution
Will not start.	The door is not closed completely.	<ul style="list-style-type: none"> <li>• Check if the door is latched and closed completely. Check whether the Upper Rack is properly joined to the Duct Nozzle.</li> <li>• Also, check if the Upper Rack is crooked or unbalanced.</li> </ul>
	The <b>Start</b> button was not pressed.	<ul style="list-style-type: none"> <li>• Check the information code on page <b>42</b> that appears on the display.</li> </ul>
	Doesn't operate at all.	<ul style="list-style-type: none"> <li>• Make sure the power cord is connected properly.</li> </ul>
	The water supply does not work.	<ul style="list-style-type: none"> <li>• Check if the water supply valve is open.</li> <li>• Check if the supplied water pressure is between 20 and 120 psi (between 140 and 830 kPa).</li> </ul>
	The Control Panel is locked.	<ul style="list-style-type: none"> <li>• Unlock the Control Lock, (See page <b>30</b>.)</li> </ul>
	A circuit breaker is open.	<ul style="list-style-type: none"> <li>• Reset the circuit breaker.</li> </ul>
An operation or cycle is taking too long.	The dishwasher is connected to a cold water supply.	<ul style="list-style-type: none"> <li>• Check if the water supply line is connected to a cold water supply. To work properly, the dishwasher must be connected to a hot water supply. (If connected to a cold water supply, additional time is required to heat the cold water.)</li> </ul>

# Troubleshooting

Problem	Possible cause	Solution
There are food particles remaining on dishes. (Not cleaning properly.)	The cycle selected was unsuitable.	<ul style="list-style-type: none"> <li>Select a cycle according to the number and soil level of the dishes, as directed in this manual.</li> </ul>
	The water temperature is low.	<ul style="list-style-type: none"> <li>Connect the water supply line to a hot water supply. For best performance, the temperature of the supplied water should be 120 °F (49 °C).</li> </ul>
	Low water pressure.	<ul style="list-style-type: none"> <li>The water pressure should be between 20 and 120 psi (140-830 kPa).</li> </ul>
	The water is too hard. (water hardness)	<ul style="list-style-type: none"> <li>Use a commercial dishwasher cleaner.</li> <li>Use high-quality, fresh detergent with rinse aid.</li> </ul>
	Dishwasher detergent was not used.	<ul style="list-style-type: none"> <li>Use automatic dishwasher detergent.</li> <li>Recommended a powder type or multi-function tablet dishwasher detergent.</li> </ul>
	Detergent remains in the dispenser.	<ul style="list-style-type: none"> <li>Make sure large items such as cookie sheets, cutting boards, or containers, etc. are not blocking the detergent dispenser and preventing it from opening properly.</li> <li>Rearrange the dishes so they do not interfere with detergent dispenser operation.</li> </ul>

Problem	Possible cause	Solution
There are food particles remaining on dishes. (Not cleaning properly.)	There is no rinse aid.	<ul style="list-style-type: none"> <li>• Check the dispenser and add rinse aid.</li> <li>• Use liquid type rinse aid.</li> </ul>
	A nozzle is clogged.	<ul style="list-style-type: none"> <li>• Clean the nozzle. See page 32.</li> </ul>
	The dishes are improperly loaded. Too many dishes have been loaded.	<ul style="list-style-type: none"> <li>• Rearrange the dishes so they do not interfere with nozzle rotation and detergent dispenser operation.</li> <li>• Load only an appropriate number of dishes.</li> <li>• Load your dishes as recommended. (See page 14.)</li> </ul>
	The filters are clogged or not correctly fastened. (Food soils remain on the filter.)	<ul style="list-style-type: none"> <li>• Scrape food from dishes prior to loading. (Do not pre-rinse.)</li> <li>• Clean the filter. (See page 33.)</li> <li>• Make sure the filters are correctly fastened.</li> </ul>
	Less water than required is supplied.	<ul style="list-style-type: none"> <li>• Check if the supplied water pressure is between 20 and 120 psi (between 140 and 830 kPa).</li> </ul>
Leaves glasses with a light film.	The water supplied is hard and too much detergent was used.	<ul style="list-style-type: none"> <li>• Underload the dishwasher and use a rinse aid to minimize this.</li> </ul>
	Aluminum dishes were included in the wash load.	<ul style="list-style-type: none"> <li>• Remove the marks on the dishes using a low sensitivity cleaner.</li> </ul>
Leaves a yellow or brown film on the inside of the dishwasher.	This is caused by coffee and tea soils.	<ul style="list-style-type: none"> <li>• Remove the soils using a spot cleaner.</li> <li>• Use a cycle with a higher temperature.</li> </ul>

# Troubleshooting

Problem	Possible cause	Solution
Does not dry dishes well.	There is no rinse aid in the dispenser or not enough rinse aid was used.	<ul style="list-style-type: none"> <li>• Check the dispenser and add rinse aid.</li> <li>• Use a liquid type rinse aid.</li> <li>• Check the rinse aid settings.</li> </ul>
	The temperature of the water is low when the dishwasher is running.	<ul style="list-style-type: none"> <li>• Connect the water supply line to a hot water supply.</li> <li>• Use rinse aid with the <b>Sanitize</b> option.</li> </ul>
	Too many dishes have been loaded.	<ul style="list-style-type: none"> <li>• Proper loading of items can affect drying.</li> <li>• Load your dishes as recommended. (See page 14.)</li> </ul>
	Glasses and cups with concave bottoms hold water. This water may spill onto other items when you unload.	<ul style="list-style-type: none"> <li>• After finishing the cycle, empty the lower rack first and then the upper rack. This will prevent water dripping from the upper rack onto the dishes in the lower rack.</li> </ul>
	Auto Release™ Dry is turned off.	<ul style="list-style-type: none"> <li>• Turn Auto Release™ Dry on.</li> </ul>
	Multiple detergent tablets were used without selecting the <b>Sanitize</b> option.	<ul style="list-style-type: none"> <li>• Select the <b>Sanitize</b> option or use rinse aid.</li> </ul>
Has a bad odor.	Water was left over from an incomplete cycle.	<ul style="list-style-type: none"> <li>• Clean the dishwasher by running the <b>Heavy</b> cycle with the dishwasher empty and no detergent.</li> </ul>
	The Drain Hose is obstructed.	<ul style="list-style-type: none"> <li>• Contact a qualified service technician to remove any obstruction from the drain hose.</li> </ul>
	The dishwasher is not used daily or soiled dishes are left in unit too long.	<ul style="list-style-type: none"> <li>• With the dishwasher empty and no detergent, place a glass with 8 ounces of vinegar upright into the lower rack, and then run a <b>Heavy</b> cycle.</li> </ul>

Problem	Possible cause	Solution
Is too noisy.	Sound is generated when the dispenser cover is open and the drain pump is operating in an early stage.	<ul style="list-style-type: none"> <li>This is normal operation.</li> </ul>
	The dishwasher is not leveled.	<ul style="list-style-type: none"> <li>Ensure the dishwasher is leveled properly.</li> </ul>
	Foreign material (a screw, a plastic piece) is in the pump chamber.	<ul style="list-style-type: none"> <li>Contact a qualified service technician to remove foreign material from the pump chamber.</li> </ul>
	There is a 'chopping' sound because a nozzle is bumping against the dishes.	<ul style="list-style-type: none"> <li>Rearrange the dishes.</li> </ul>
	Less water than required is supplied.	<ul style="list-style-type: none"> <li>Check if the supplied water pressure is between 20 and 120 psi (between 140 and 830 kPa).</li> </ul>
Does not have a smoothly rotating nozzle.	Nozzle holes are clogged with food particles.	<ul style="list-style-type: none"> <li>Clean the nozzle holes. (See page 32.)</li> </ul>
	The nozzle is blocked by a dish or pot and cannot rotate.	<ul style="list-style-type: none"> <li>After placing the dishes into the racks, rotate the nozzles by hand to check whether any of the dishes interfere with them.</li> </ul>
Water won't pump out of the dishwasher.	The drain is clogged.	<ul style="list-style-type: none"> <li>Contact a qualified service technician to remove any obstruction from the drain hose and check the drain pump operation.</li> </ul>
Has a bent upper rack after dishes are loaded.	The dishes are not loaded properly.	<ul style="list-style-type: none"> <li>Load your dishes as recommended. (See page 14.)</li> </ul>
Cannot close the door.	Auto Release™ Dry mode is in operation.	<ul style="list-style-type: none"> <li>Once the door opens in the Auto Release™ Dry mode, the door cannot be closed manually for the next 2 minutes. You may close the door after 2 minutes.</li> </ul>

# Troubleshooting

## Information codes

The Control Panel displays information codes to help you understand what is occurring with your dishwasher.

Code	Action
1C	<b>Low-water level check</b> <ul style="list-style-type: none"><li>• Check if the filter is clogged.</li><li>• Make sure to use dishwasher detergent.</li><li>• Make sure that the dishes are loaded evenly.</li><li>• Turn the dishwasher off and turn it on again. Then, try again.</li></ul>
3C	<b>Pump operation check.</b> <ul style="list-style-type: none"><li>• Functional check. Turn off the dishwasher and try to start it again. If the problem continues, contact an authorized Samsung service center.</li></ul>
4C	<b>Water supply check.</b> <ul style="list-style-type: none"><li>• Check if the water supply valve is closed or clogged, or is frozen. Also check if the supplied water pressure is less than required. If the problem continues, close the water supply valve, and then contact an authorized Samsung service center.</li></ul>
5C	<b>Drain check.</b> <ul style="list-style-type: none"><li>• After closing the water supply valve, check whether the drain hose is clogged or folded. Also, check whether the drain hole inside the sump is clogged. If the problem continues, contact an authorized Samsung service center.</li></ul>
HC	<b>High temperature heating check.</b> <ul style="list-style-type: none"><li>• Functional check. With the dishwasher empty, add detergent, and then run a cycle. If the problem continues, go to your house circuit breaker panel, set the dishwasher's circuit breaker switch to off, and then contact an authorized Samsung service center.</li></ul>
LC	<b>Leakage check / Overflow check</b> <ul style="list-style-type: none"><li>• If a leak occurs on the water supply valve connection, close the water supply valve and go to your house circuit breaker panel, set the dishwasher's circuit breaker switch to off, and then contact the installer to fix. If the problem continues, contact an authorized Samsung service center.</li><li>• After closing the water supply valve, check if there is any drainage problem or leak problem.</li></ul>

---

Code	Action
PC	<p>Zone wash function check.</p> <ul style="list-style-type: none"><li>Functional check. Turn off the dishwasher and try to start it again.</li></ul> <p>If the problem continues, contact an authorized Samsung service center.</p>

For any codes not listed above, call 1-800-SAMSUNG (726-7864).

# Cycle chart

Cycle		Auto	Normal	Heavy
Cycle sequence		Prewash ▶ Mainwash ▶ Rinse ▶ Hot Rinse ▶ Dry ▶ End	Prewash ▶ Mainwash ▶ Rinse ▶ Hot Rinse ▶ Dry ▶ End	Prewash ▶ Mainwash ▶ Rinse ▶ Hot Rinse ▶ Dry ▶ End
Temp [°F (°C)]	Main wash	113-140 (45-60)	108-136 (42-58)	146 (63)
	Hot Rinse *Sanitize 163 °F (73 °C)	144-149 (62-65)	140-144 (60-62)	149 (65)
Water consumption [gal (ℓ)]		2.6-5.1 (9.7-19.2)	2.6-5.1 (9.7-19.2)	5.1 (19.2)
Cycle time (min)		111-138	105-150	152
Available Options	Lower Rack	0	0	0
	Hi-Temp Wash	0	0	0
	Sanitize	0	0	0
	Delay Start	0	0	0

Cycle chart

Cycle		Delicate	Express 60'
Cycle sequence		Prewash ▶ Mainwash ▶ Rinse ▶ Hot Rinse ▶ Dry ▶ End	Prewash ▶ Mainwash ▶ Rinse ▶ Hot Rinse ▶ Dry ▶ End
Temp [°F (°C)]	Main wash	122 (50)	131 (55)
	Hot Rinse *Sanitize 163 °F (73 °C)	140 (60)	131 (55)
Water consumption [gal (ℓ)]		4.2 (16)	3.4 (12.9)
Cycle time (min)		112	60
Available Options	Lower Rack	0	0
	Hi-Temp Wash	X	0
	Sanitize	X	0
	Delay Start	0	0

- When you select the **Auto** or **Normal** cycle, running the **Prewash** and **Rinse** cycles depends on the soil level of the load.
- The water consumption and wash time varies depending on the steps or options you add, and on the pressure and temperature of the supplied water.
- When you select any options, the cycle time can be changed.
- It is stated that the actual water temperature may differ from the declared cycle temperature.

Cycle chart

# Appendix

## Helping the environment

- Your dishwasher is manufactured from recyclable materials. If you decide to dispose of it, please observe local waste disposal regulations. Cut off the power cord so that the appliance cannot be connected to a power source.
- Remove the door so that animals and small children cannot get trapped inside the appliance.
- Do not exceed the detergent quantities recommended in the detergent manufacturers' instructions.

## Specifications

MODEL	DW80DG5500SR / DW80DG5200SR / DW70H83YEUR / DW70H83YETR	
Type	Built-in Dishwasher	
Power	120 V / 60 Hz AC only, 15 A circuit breaker	
Wash capacity	15 place settings	
Used water pressure	20-120 psi (140-830 kPa)	
Rated power usage	Wash Motor	30-95 W
	Heater	1000 W
Dimensions (Width × Depth × Height)	23 $\frac{3}{8}$ × 24 $\frac{3}{4}$ × 33 $\frac{3}{8}$ in. (605 × 627 × 860 mm) 23 $\frac{3}{8}$ × 27 × 33 $\frac{3}{8}$ in. (605 × 686 × 860 mm) (DW70H83YETR only)	
Weight (Unpacked)	DW80DG5500**: 83.8 lb (38 kg) DW80DG5200**: 79.4 lb (36 kg) DW70H83YE**: 83.8 lb (38 kg)	

# Warranty (U.S.A)

---

## SAMSUNG DISHWASHER

### LIMITED WARRANTY TO ORIGINAL CONSUMER PURCHASER WITH PROOF OF PURCHASE AND/OR PROOF OF DELIVERY

This SAMSUNG brand product, as supplied and distributed by SAMSUNG ELECTRONICS AMERICA, INC. (SAMSUNG) and delivered new, in the original carton to the original consumer purchaser, is warranted by SAMSUNG against manufacturing defects in materials or workmanship for the following limited warranty periods, starting on the date of delivery to the original consumer purchaser:

One (1) year parts and labor

Five (5) years, Printed Circuit Board, Racking and Stainless Door Liner & Tub for leakage (Parts Only)

This limited warranty is valid only on products purchased and used in the United States that have been installed, operated, and maintained according to the instructions attached to or furnished with the product. To receive warranty service, the purchaser must contact SAMSUNG at the address or phone number provided below for problem determination and service procedures. Warranty service can only be performed by a SAMSUNG authorized service center. The original dated bill of sale or proof of delivery must be presented upon request to SAMSUNG or SAMSUNG's authorized service center to receive warranty service.

SAMSUNG will provide in-home service within the contiguous United States during the warranty period at no charge, subject to availability of SAMSUNG authorized servicers within the customer's geographic area. If the product is located in an area where service by a SAMSUNG authorized servicer is not available, you may be responsible for a trip charge or required to bring the product to a SAMSUNG authorized service center for service.

To receive in-home service, product must be unobstructed and accessible to the service agent.

During the applicable warranty period, a product will be repaired, replaced, or the purchase price refunded, at the sole option of SAMSUNG. SAMSUNG may use new or reconditioned parts in repairing a product, or replace the product with a new or reconditioned product. Replacement parts and products are warranted for the remaining portion of the original product's warranty or ninety (90) days, whichever is longer. All replaced parts and products are the property of SAMSUNG and you must return them to SAMSUNG.

Warranty (U.S.A)

# Warranty (U.S.A)

---

This limited warranty covers manufacturing defects in materials or workmanship encountered in normal household, noncommercial use of this product and shall not cover the following: damage that occurs in shipment, delivery, installation, and uses for which this product was not intended; damage caused by unauthorized modification or alteration of the product; product where the original factory serial numbers have been removed, defaced, changed in any way, or cannot be readily determined; cosmetic damage including scratches, dents, chips, and other damage to the product's finishes; damage caused by abuse, misuse, pest infestations, accident, fire, floods, or other acts of nature or God; damage caused by use of equipment, utilities, services, parts, supplies, accessories, applications, installations, repairs, external wiring or connectors not supplied or authorized by SAMSUNG; damage caused by incorrect electrical line current, voltage, fluctuations and surges; damage caused by failure to operate and maintain the product according to instructions; in-home instruction on how to use your product; and service to correct installation not in accordance with electrical or plumbing codes or correction of household electrical or plumbing (that is house wiring, fuses, or water inlet hoses).

The cost of repair or replacement under these excluded circumstances shall be the customer's responsibility.

Visits by an authorized servicer to explain product functions, maintenance or installation are not covered by this limited warranty. Please contact SAMSUNG at the number below for assistance with any of these issues.

## EXCLUSION OF IMPLIED WARRANTIES

IMPLIED WARRANTIES, INCLUDING THE IMPLIED WARRANTIES OF MERCHANTABILITY OR FITNESS FOR A PARTICULAR PURPOSE, ARE LIMITED TO ONE YEAR OR THE SHORTEST PERIOD ALLOWED BY LAW. Some states do not allow limitations on how long an implied warranty lasts, so the above limitations or exclusions may not apply to you. This warranty gives you specific rights, and you may also have other rights, which vary from state to state.

---

## LIMITATION OF REMEDIES

YOUR SOLE AND EXCLUSIVE REMEDY IS PRODUCT REPAIR, PRODUCT REPLACEMENT, OR REFUND OF THE PURCHASE PRICE AT SAMSUNG'S OPTION, AS PROVIDED IN THIS LIMITED WARRANTY. SAMSUNG SHALL NOT BE LIABLE FOR SPECIAL, INCIDENTAL OR CONSEQUENTIAL DAMAGES, INCLUDING BUT NOT LIMITED TO TIME WAY FROM WORK, HOTELS AND/OR RESTAURANT MEALS, REMODELING EXPENSES, LOSS OF REVENUE OR PROFITS, FAILURE TO REALIZE SAVINGS OR OTHER BENEFITS REGARDLESS OF THE LEGAL THEORY ON WHICH THE CLAIM IS BASED, AND EVEN IF SAMSUNG HAS BEEN ADVISED OF THE POSSIBILITY OF SUCH DAMAGES. Some states do not allow exclusion or limitation of incidental or consequential damages, so the above limitations or exclusions may not apply to you. This warranty gives you specific rights, and you may also have other rights, which vary from state to state.

SAMSUNG does not warrant uninterrupted or error-free operation of the product. No warranty or guarantee given by any other person, firm, or corporation with respect to this product shall be binding on SAMSUNG.

To obtain warranty service, please contact SAMSUNG at:

### In USA

Samsung Electronics America, Inc.  
700 Sylvan Avenue,  
Englewood Cliffs, NJ 07632  
1-800-SAMSUNG (726-7864)  
[www.samsung.com/us/support](http://www.samsung.com/us/support)

Warranty (U.S.A)

# Warranty (CANADA)

---

## SAMSUNG DISHWASHER

### LIMITED WARRANTY TO ORIGINAL PURCHASER

This SAMSUNG brand product, as supplied and distributed by SAMSUNG ELECTRONICS CANADA, INC. (SAMSUNG) and delivered new, in the original carton to the original consumer purchaser, is warranted by SAMSUNG against manufacturing defects in materials and workmanship for a limited warranty period of:

One (1) year parts and labor

Five (5) years, Printed Circuit Board, Racking and Stainless Door Liner & Tub for leakage (Parts Only)

This limited warranty begins on the original date of purchase, and is valid only on products purchased and used in the Canada. To receive warranty service, the purchaser must contact SAMSUNG for problem determination and service procedures. Warranty service can only be performed by a SAMSUNG authorized service center. The original dated bill of sale must be presented upon request as proof of purchase to SAMSUNG or SAMSUNG's authorized service center. SAMSUNG will provide in-home service during the warranty period at no charge, subject to availability within the contiguous Canada.

In home service is not available in all areas.

To receive in-home service, product must be unobstructed and accessible to the service agent.

SAMSUNG will repair, replace, or refund this product at our option and at no charge as stipulated herein, with new or reconditioned parts or products if found to be defective during the limited warranty period specified above. All replaced parts and products become the property of SAMSUNG and must be returned to SAMSUNG. Replacement parts and products assume the remaining original warranty, or ninety (90) days, whichever is longer.

---

This limited warranty covers manufacturing defects in materials and workmanship encountered in normal, noncommercial use of this product and shall not apply to the following: damage that occurs in shipment; delivery and installation; applications and uses for which this product was not intended; altered product or serial numbers; cosmetic damage or exterior finish; accidents, abuse, neglect, fire, water, lightning, or other acts of nature or God; use of products, equipment, systems, utilities, services, parts, supplies, accessories, applications, installations, repairs, external wiring or connectors not supplied or authorized by SAMSUNG that damage this product or result in service problems; incorrect electrical line voltage, fluctuations and surges; customer adjustments and failure to follow operating instructions, maintenance and environmental instructions that are covered and prescribed in the instruction book; product removal and reinstallation; problems caused by pest infestations. This limited warranty does not cover problems resulting from incorrect electric current, voltage or supply, light bulbs, house fuses, house wiring, cost of a service call for instructions, or fixing installation errors. SAMSUNG does not warrant uninterrupted or error-free operation of the product.

EXCEPT AS SET FORTH HEREIN, THERE ARE NO WARRANTIES ON THIS PRODUCT EITHER EXPRESS OR IMPLIED, AND SAMSUNG DISCLAIMS ALL WARRANTIES INCLUDING, BUT NOT LIMITED TO, ANY IMPLIED WARRANTIES OF MERCHANTABILITY, INFRINGEMENT OR FITNESS FOR A PARTICULAR PURPOSE. NO WARRANTY OR GUARANTEE GIVEN BY ANY PERSON, FIRM, OR CORPORATION WITH RESPECT TO THIS PRODUCT SHALL BE BINDING ON SAMSUNG. SAMSUNG SHALL NOT BE LIABLE FOR LOSS OF REVENUE OR PROFITS, FAILURE TO REALIZE SAVINGS OR OTHER BENEFITS, OR ANY OTHER SPECIAL, INCIDENTAL OR CONSEQUENTIAL DAMAGES CAUSED BY THE USE, MISUSE, OR INABILITY TO USE THIS PRODUCT, REGARDLESS OF THE LEGAL THEORY ON WHICH THE CLAIM IS BASED, AND EVEN IF SAMSUNG HAS BEEN ADVISED OF THE POSSIBILITY OF SUCH DAMAGES.

NOR SHALL RECOVERY OF ANY KIND AGAINST SAMSUNG BE GREATER IN AMOUNT THAN THE PURCHASE PRICE OF THE PRODUCT SOLD BY SAMSUNG AND CAUSING THE ALLEGED DAMAGE.

WITHOUT LIMITING THE FOREGOING, PURCHASER ASSUMES ALL RISK AND LIABILITY FOR LOSS, DAMAGE, OR INJURY TO PURCHASER AND PURCHASER'S PROPERTY AND TO OTHERS AND THEIR PROPERTY ARISING OUT OF THE USE, MISUSE, OR INABILITY TO USE THIS PRODUCT. THIS LIMITED WARRANTY SHALL NOT EXTEND TO ANYONE OTHER THAN THE ORIGINAL PURCHASER OF THIS PRODUCT, IS NONTRANSFERABLE AND STATES YOUR EXCLUSIVE REMEDY.

# Warranty (CANADA)

---

Some states or provinces do not allow limitations on how long an implied warranty lasts, or the exclusion or limitation of incidental or consequential damages, so the above limitations or exclusions may not apply to you. This warranty gives you specific rights, and you may also have other rights, which vary from state to state or province to province.

To obtain warranty service, please contact SAMSUNG at:

In CANADA

Samsung Electronics Canada Inc.

2050 Derry Road West

Mississauga, Ontario L5N 0B9 Canada

1-800-SAMSUNG (726-7864)

[www.samsung.com/ca/support](http://www.samsung.com/ca/support) (English)

[www.samsung.com/ca\\_fr/support](http://www.samsung.com/ca_fr/support) (French)

# Memo

---

# Memo

---

# Memo

---

# SAMSUNG



Scan the QR code\* or visit  
[www.samsung.com/spsn](http://www.samsung.com/spsn)  
to view our helpful  
How-to Videos and Live Shows

\*Requires reader to be installed on your smartphone

[bit.ly/samsungdishwashers](http://bit.ly/samsungdishwashers)

## QUESTIONS OR COMMENTS?

COUNTRY	CALL	OR VISIT US ONLINE AT
U.S.A - Consumer Electronics - Mobile Phones	1-800-SAMSUNG (726-7864) 1-844-SAM-PAYS (726-7297)	<a href="http://www.samsung.com/support">www.samsung.com/support</a>
CANADA	1-800-Samsung (726-7864)	

