

36-Inch Dual-Fuel Steam Range

\$8,999 | TRANSITIONAL

dacor



DOP36T86DLS/DA - Silver Stainless, Natural Gas

Features & Benefits

- Steam-Assist oven
- Dual Four-Part Pure Convection system
- SimmerSear™ brass burners
- Halogen lighting
- OLED control panel with SmartThings Wi-Fi connectivity
- Perma-Flame™
- Auto Connect to compatible ventilation through Bluetooth
- Digital temperature probe
- Self-clean oven
- SoftShut™ hinges
- LP conversion kit

Controls

CONTROL TYPE	2.25" PMOLED Touchscreen & Knobs
CHEF MODE GUIDED COOKING	No
ILLUMINA™ KNOBS	White
WI-FI + SMARTTHINGS	Yes
BLUETOOTH AUTO CONNECT VENTILATION	Yes
CONTROL SHOWER LIGHTING	Yes
CLOCK	Yes
DELAY START	Yes
KITCHEN TIMER	Yes
CHILD LOCK	Yes
SABBATH MODE	Yes

Oven

OVEN CAPACITY (CU. FT.)	6.3
CONVECTION	Dual Four-Part Pure
STEAM	Steam-Assist
BAKE ELEMENT	3,000W - 8 Pass
BROIL ELEMENT	4,400W - 10 Pass
INSTANTHEAT (NO PREHEAT)	No
TEMPERATURE PROBE	Yes
LIGHTING	Halogen
SELF-CLEAN	Self-Clean, GreenClean™
SOFTSHUT™	Yes

Cooktop

NUMBER OF BURNERS	6
PERMA-FLAME™ (AUTO RE-IGNITION)	Yes
LEFT FRONT (BTU)	22,000
LEFT REAR (BTU)	16,000
CENTER FRONT (BTU)	16,000
CENTER REAR (BTU)	16,000
RIGHT FRONT (BTU)	22,000
RIGHT REAR (BTU)	16,000
BRASS BURNER CAPS	Yes
GRIDDLE	Sold Separately
WOK RING	Yes

Weights & Dimensions

NET WEIGHT (LBS.)	428
SHIPPING WEIGHT (LBS.)	504
PRODUCT DIMENSIONS (W x H x D IN INCHES)	35 7/8 x 36 x 28 3/4

Technical Details

ELECTRICAL REQUIREMENT	208/240V, 60 Hz, 40A
AVAILABLE FUEL TYPES	Natural Gas, Liquid Propane
LP CONVERSION KIT (INCLUDED)	Yes

Warranty

FULL COVERAGE	2 Years
----------------------	---------

Accessories (Optional)

ARG36	Griddle for 36" Range and Rangetop	\$349
--------------	------------------------------------	-------

36-Inch Dual-Fuel Steam Range

\$8,999 | TRANSITIONAL



Product Dimensions

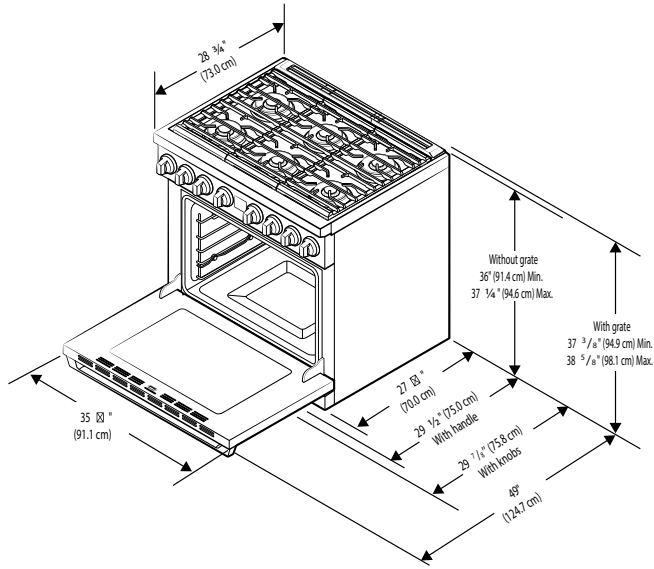

Installation Cutout Dimensions

ELECTRICAL OUTLET - (IN/CM)	7/8 (W) x 6 7/8" (H) / 25.1 x 17.5
GAS PIPING - (IN/CM)	7 3/8 (W) x 5 3/8 (H) / 18.6 x 13.8

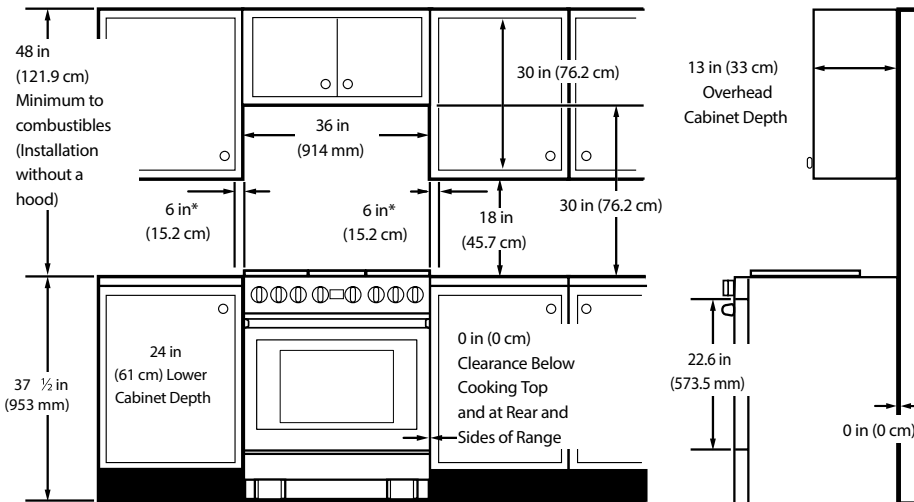

* Side clearance above cooking surface to any objects, i.e., wall.