

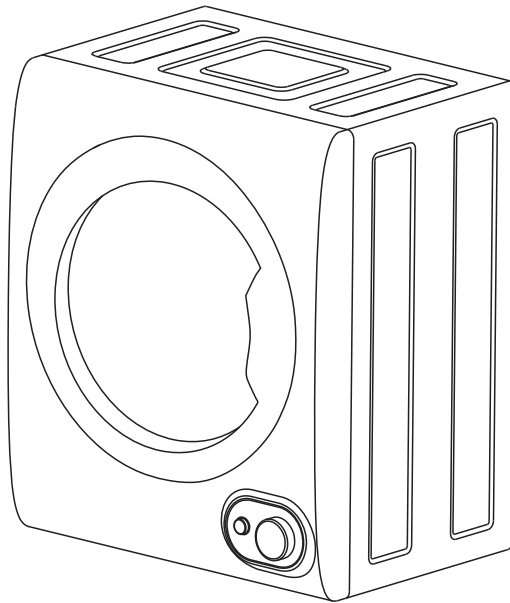

## INSTRUCTION MANUAL

Model Number : D110J2P-IS

CLOTHES DRYER



**CAUTION:**

**BEFORE USE, PLEASE READ AND FOLLOW ALL SAFETY RULES AND OPERATING INSTRUCTIONS.**

*Avanti has a policy of continuous improvement on its products and reserves the right to change materials and specifications without notice.*

---

Avanti Products  
P.O. Box 520604 - Miami, Florida 33172  
[www.avantiproducts.com](http://www.avantiproducts.com)

---

## TABLE OF CONTENTS

Help Us Help You	3
Parts and Features	4
Important Safety Instructions	5 – 7
Installation Instructions	8
Before Using Your Dryer	8
Electrical Connection	9
Wall Mounting Instructions	10
Leveling Legs	11
Control Panel	11
Operating Your Appliance	12
Temperature Control	12
Dry Mode Selector	12
Drying Time Reference	13
Sorting Fabrics	13
Fabric Care Sheet	14
Care and Maintenance	15
Cleaning Your Appliance Exterior	15
Cleaning the Filters	15
Troubleshooting Guide	16
Service for Your Appliance	16
Your Avanti Products Warranty	17
Registration Information and Registration Card	Last Page

---

## HELP US HELP YOU...

### Read this guide carefully.

It is intended to help you operate and maintain your new appliance properly.

Keep it handy to answer your questions.

If you don't understand something or your need more help, please call:

**Avanti Customer Service**  
**800-220-5570**

Keep proof of original purchase date (such as your sales slip) with this guide to establish the warranty period.

### Write down the model and serial numbers.

You'll find them on a plate located on the back wall of the appliance.

Please write these numbers here:

\_\_\_\_\_  
Date of Purchase

\_\_\_\_\_  
Model Number

\_\_\_\_\_  
Serial Number

Use these numbers in any correspondence or service calls concerning your appliance.

If you received a damaged appliance, immediately contact the dealer (or builder) that sold you the appliance.

Save time and money. Before you call for service, check the Troubleshooting Guide. It lists causes of minor operating problems that you can correct yourself.

---

## IF YOU NEED SERVICE

We're proud of our service and want you to be pleased. If for some reason you are not happy with the service you receive, here are some steps to follow for further help.

FIRST, contact the people who serviced your appliance. Explain why you are not pleased. In most cases, this will solve the problem.

NEXT, if you are still not pleased, write all the details, including your telephone number, and send to:

**Customer Service**  
**Avanti Products**  
**10880 NW 30 Street**  
**Miami, FL 33172**

# PARTS AND FEATURES

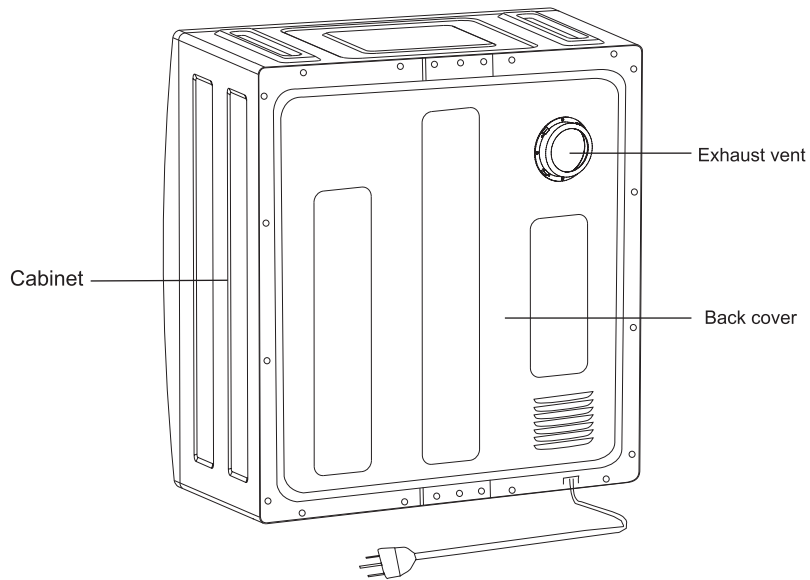
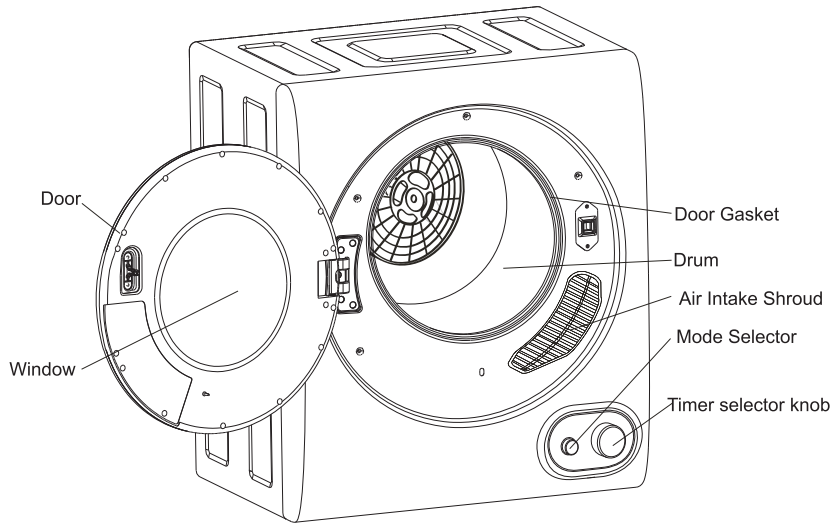



Caution, danger

**This dryer can not be used upside down**

# WARNING

## -Risk of Fire

Clothes dryer installation must be performed by a qualified installer.

Install clothes dryer according to the manufacturers instructions and local codes.

Do not install a clothes dryer with flexible plastic venting materials. If flexible metal(foil type) duct is install, it must be of a specific type identified by the appliance manufacturer as suitable for use with clothes dryers. Flexible venting materials are known to collapse, be easily crushed, and trap lint. These conditions will obstruct clothes dryer airflow and increase the risk of fire.

To reduce the risk of severe injury or death, follow all Installation instructions.

Connet To Individaul Branch Circuit.

This appliance must be grounded. In the event of malfunction or breakdown, grounding will reduce the risk of electric shock by providing a path of least resistance for eletric current. This appliance is equipped with a cord having an equipment-grounding conductor and grounded in accordance with all local codes and ordinances.

# WARNING

- Improper connection of the equipment-grounding conductor can result in a risk of electric shock. Check with a qualified electrician or service representative or personnel if you are in doubt as to whether the appliance is properly grounded. Do not modify the plug provided with the appliance: if it will not fit the outlet, have aproper outlet installed by a qualified electrician.

It must be placed on firm horizontal ground. Do not place the dryer on carpet as this will block the intake. There should be at least 10cm between the dryer and the walls.

Place the dryer in a dry well ventilated area. It should be positioned away from heat and direct sunlight.

Do not wash directly with water.

Do not use thinner, gasolene or alcohol.

Do not use any type of spray cleaner when cleaning the interior. If dryer drum becomes stained, clean the drum with a damp cloth.

Remove any residue before drying the next load.

Clean cabinet with mild soap and water. Do not use harsh or abrasive cleaners, this could damage the dryer.



**When using electrical appliances, in order to reduce the risk of fire, electric shock, and/or injury to persons, basic safety precautions should always be followed, including:**

*For Your Safety*

***Read all instructions carefully, even if you are quite familiar with the appliance.***

- This appliance is not intended for use by persons (including children) with reduced physical, sensory or mental capabilities, or lack of experience and knowledge, unless they have been given supervision or instruction concerning use of the appliance by a person responsible for their safety.
- Do not allow children to play on or in the appliance. Close supervision of children is necessary when the appliance is used near children.
- **INDOOR USE ONLY** - this appliance is not intended for outdoor use.
- Do not place naked flame sources, such as candles, on the appliance.
- Do not locate the appliance or cord near heat sources such as radiators, heaters, air ducts or direct sunlight.
- Do not block any of the ventilation openings. Ensure that vents are not covered by newspapers, tablecloths, curtains, etc
- Do not run the cord under floor coverings. Instead, arrange the cord away from traffic areas where it will not become a trip hazard.
- To disconnect the appliance, turn the appliance off, switch off the power outlet and remove the plug from the power outlet.
- Do not misuse the cord. Never carry the appliance by the cord or pull to disconnect it from the outlet. Instead, grasp the plug and pull to disconnect.
- Do not operate the appliance if it has a damaged cord or plug; after the appliance malfunctions;
- or has been dropped or damaged in any way. Consult the manufacturer.
- Do not attempt to repair, disassemble or modify this appliance. The warranty becomes void if not serviced or repaired by a qualified person.
- Do not reach into the appliance if the drum is moving.
- Do not place items that have been soiled with flammable liquids inside the dryer without washing them with detergent thoroughly before hand.
- Do not excessively bend, stretch, twist or bind the power cord or place heavy objects on it.
- This appliance is only to be serviced by a qualified person. There are no user-serviceable parts inside.
- Do not install in a tight-fitting cabinet.
- Do not overload the tumble dryer.
- Do not dry articles that have been previously cleaned in, washed in, soaked in, or spotted with gasoline, dry-cleaning solvents, or other flammable or explosive substances, as they give off vapors that could ignite or explode.
- Before the appliance is removed from service or discarded, remove the door to the drying compartment.
- Do not install or store this appliance where it will be exposed to the weather.
- Do not tamper with controls.
- Do not repair or replace any part of the appliance or attempt any servicing unless specifically recommended in the user-maintenance instructions or in published user-repair instructions that you understand and have the skills to carry out.
- Do not use fabric softeners or products to eliminate static unless recommended by the manufacturer of the fabric softener or product.
- Do not use heat to dry articles containing foam rubber or similarly textured rubber-like materials.
- Keep area around the exhaust opening and adjacent surrounding areas free from the accumulation of lint, dust, and dirt.
- The interior of the appliance and exhaust duct should be cleaned periodically by qualified

- service personnel.
- Do not place items exposed to cooking oils in your dryer. Items contaminated with cooking oils may contribute to a chemical reaction that could cause a load to catch fire.
- Ensure foreign objects do not find their way into the tub of the tumble dryer.
- Clean lint screen before or after each load

## Important Safety Instructions

<b>⚡WARNING⚡</b>	To reduce the risk of fire, electrical shock, or injury when using your appliance, follow these basic precautions:
<ul style="list-style-type: none"> <li>• Read all instructions before using the appliance.</li> <li>• <b>DANGER or WARNING:</b> Risk of child entrapment.</li> <li>• Child entrapment and suffocation are not problems of the past. Junked or abandoned appliances are still dangerous. . . even if they will just sit in the garage a few days.?</li> <li>• <b>Before you throw away your old appliance:</b> Take off the door so that children may not easily climb inside.</li> <li>• Never allow children to operate, play with, or crawl inside the appliance.</li> <li>• Never clean appliance parts with flammable fluids. The fumes can create a fire hazard or explosion.</li> <li>• Do not place the dryer in steamy rooms or where the dryer is directly exposed to rain. Moisture may destroy the electrical insulation causing an electrical shock hazard.</li> <li>• During spinning, don't put your hand in the spin basket: Because the spin basket is rotating at high speed, rotating parts may injure your hand.</li> <li>• Do not store or use gasoline or any other flammable vapors and liquids in the vicinity of this or any other appliance. The fumes can create a fire hazard or explosion.</li> </ul> <p style="text-align: center;">-Save these instructions-</p>	

## INSTALLATION INSTRUCTIONS

### **Before Using Your Appliance**

- Remove the exterior and interior packing.
- Check to be sure you have all of the following parts:
  - Instruction Manual
- Allow at least 5 inches of space between the sides of the appliance.
- Put your laundry into the dryer evenly. Uneven laundry may cause noise or vibration.
- Before drying, check all pockets. If nails or pins remain in pockets, they may damage the dryer or clothes.
- Never splash water on the control panel.
- Plug the dryer into an exclusive properly installed grounded wall outlet. Do not under any circumstances cut or remove the third (ground) prong from the power cord. Any questions concerning power and or grounding should be directed toward a certified electrician or an authorized Avanti Products service center.

### **Selecting a Location**

Before you install the dryer, select a location with the following characteristics:

- A hard level surface (if the surface is uneven, see ?Adjusting the Leveling Legs?).
- If you are going to wall mount your dryer using the wall mounting kit included (see ?Wall Mounting Instructions?).
- Away from direct sunlight. Direct sunlight may affect the acrylic coating, plastic and electrical components.
- Adequate ventilation
- Room temperature that will not fall below 0° C/ 32°F.
- Away from sources of heat such as coal or gas. Make sure that the dryer does not stand on its power cord. Ventilation openings must not be obstructed by carpeting when the dryer is installed on a carpeted floor.





## Electrical Connection

### ⚡Warning⚡

Improper use of the grounded plug can result in the risk of electrical shock. If the power cord is damaged, have it replaced by an authorized Avanti Products service center.

This appliance should be properly grounded for your safety. The power cord of this appliance is equipped with a three-prong plug which mates with standard three prong wall outlets to minimize the possibility of electrical shock.

Do not under any circumstances cut or remove the third ground prong from the power cord supplied.

This appliance requires a standard 115Volts~/60Hz electrical outlet with three-prong ground.

The cord should be secured behind the appliance and not left exposed or dangling to prevent accidental injury.

Never unplug the appliance by pulling the power cord. Always grip the plug firmly and pull straight out from the receptacle.

Do not use an extension cord with the appliance. If the power cord is too short, have a qualified electrician or service technician install an outlet near the appliance.

### **EXTENSION CORD**

Because of potential safety hazards under certain conditions, it is strongly recommended that you do not use an extension cord with this unit. However, if you must use an extension cord it is absolutely necessary that it be a UL/CUL-Listed, 3-wire grounding type appliance extension cord having a grounding type plug and outlet and that the electrical rating of the cord be 115 volts and at least 10 amperes.

### **SURGE PROTECTOR**

Most electrical appliances use a series of electric control boards to operate. These boards are very susceptible to power surges and could be damaged or destroyed.

If the appliance is going to be used in an area or if your city / country is prone to power surges / outages; it is suggested that you use a power surge protector for all electrical devices / appliances you use. The surge protector that you select must have a surge block high enough to protect the appliance it is connected to. If you have any questions regarding the type and size of surge protector needed contact a licensed electrician in your area.

Damages due to power surges are not considered a manufacturer covered defect and will void your product warranty.

## ➤ Wall Mounting Instructions

It is recommended to complete the following procedure with at least 2 people.

Tools Required		
Tools and parts required for Plaster and or Wood Installation	Drill & Drill Bit	1
	Phillips Head Screw Driver	1
	Wood screws 50mm long	4

Wall Mounting Kit Includes the following			
Description	Wall Hanging Bracket		2
	Wall Hanging Hook		2
	Exhaust connector		1
	12mm long Screws		4
	25mm long Screws		4

1. Determine dryer position on wall and mark required bracket position. This dryer is not suitable to be directly placed on top of a washing machine.

\* A minimum 50mm is needed between the top of the dryer and the ceiling for ease of installation.

\* If mounting above a washing machine, allow sufficient room to open the lid of the washer.

2. Fix the wall hanging brackets (2 supplied) to the wall securely (e.g. into the stud). Fit a timber slat between the studs to mount the brackets onto if the stud position is too wide.

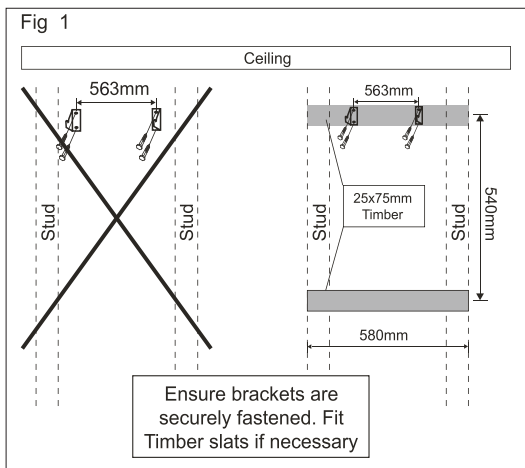

3. Install the Wall Hanging Hooks as shown in illustration (Fig. 2).

4. Align hanging hooks and fasten screws tightly.

5. Install the exhaust pipe as shown in illustration (Fig. 3). (Align the Exhaust pipe to the Exhaust Vent and turn Clockwise)

6. The exhaust vent can be locked into the position that best fits your needs. (Upward, Downward or venting to either side left or right).

7. Using 4×12mm screws (provided) to fix the 2 Wall Hanging Bracket as per Fig 4.

8. With assistance, mount dryer on wall bracket. See Fig 5.

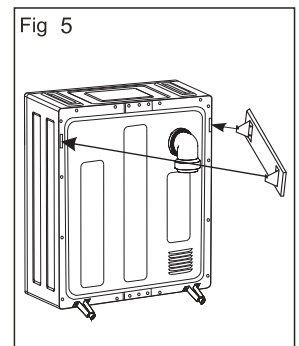
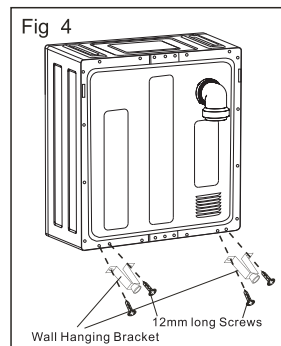
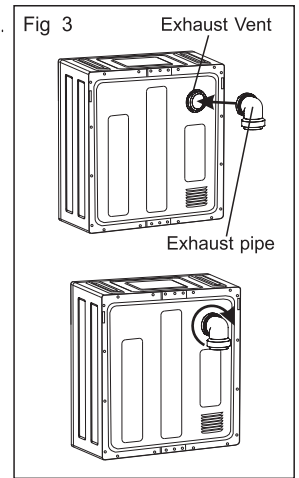
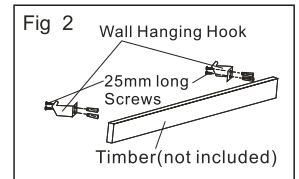

The appliance shall not be exhausted into a chimney, a wall, a ceiling, an attic, a crawl space, or a concealed space of a building.

Only rigid or flexible metal duct shall be used for exhausting.

In Canada, that only those foil-type flexible ducts, if any, specifically identified for use with the appliance by the manufacturer shall be used. In the United States, that only those foil-type flexible ducts, if any, specifically identified for use with the appliance by the manufacturer and that comply with the outline for Clothes Dryer Transition Duct, Subject 2158A, shall be used.

In Canada, that the exhaust duct shall be 102 mm in diameter. In the United States, the required exhaust duct diameter.

That the total length of flexible metal duct shall not exceed 2.4 m.

That the duct shall not assembled with screws or other fastening means that extend into the duct and catch lint.

## **Adjusting the leveling legs**

Your dryer is shipped with the legs in the bag containing your user's guide. To install and adjust the leveling legs see the illustration to the right.

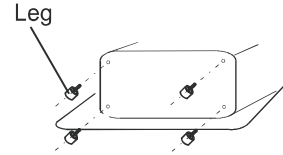

If the floor is uneven adjust the legs (do not insert pieces of wood, or any other objects under the legs)

- Adjust the height level of the legs accordingly.

Place the dryer on a sturdy flat surface.

If the dryer is placed on an uneven or weak surface, noise or vibration will occur. (Allowable is 1°)

## **CONTROL PANEL**

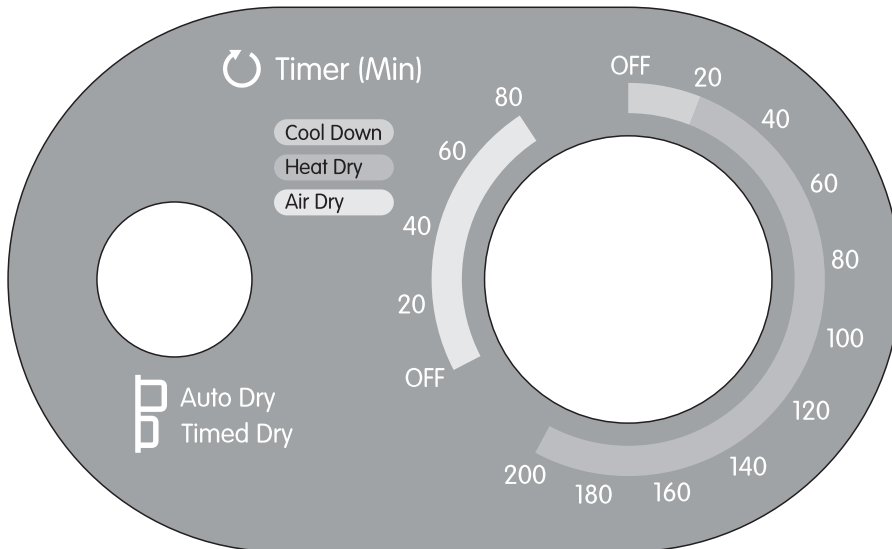

## ➤ OPERATING INSTRUCTIONS

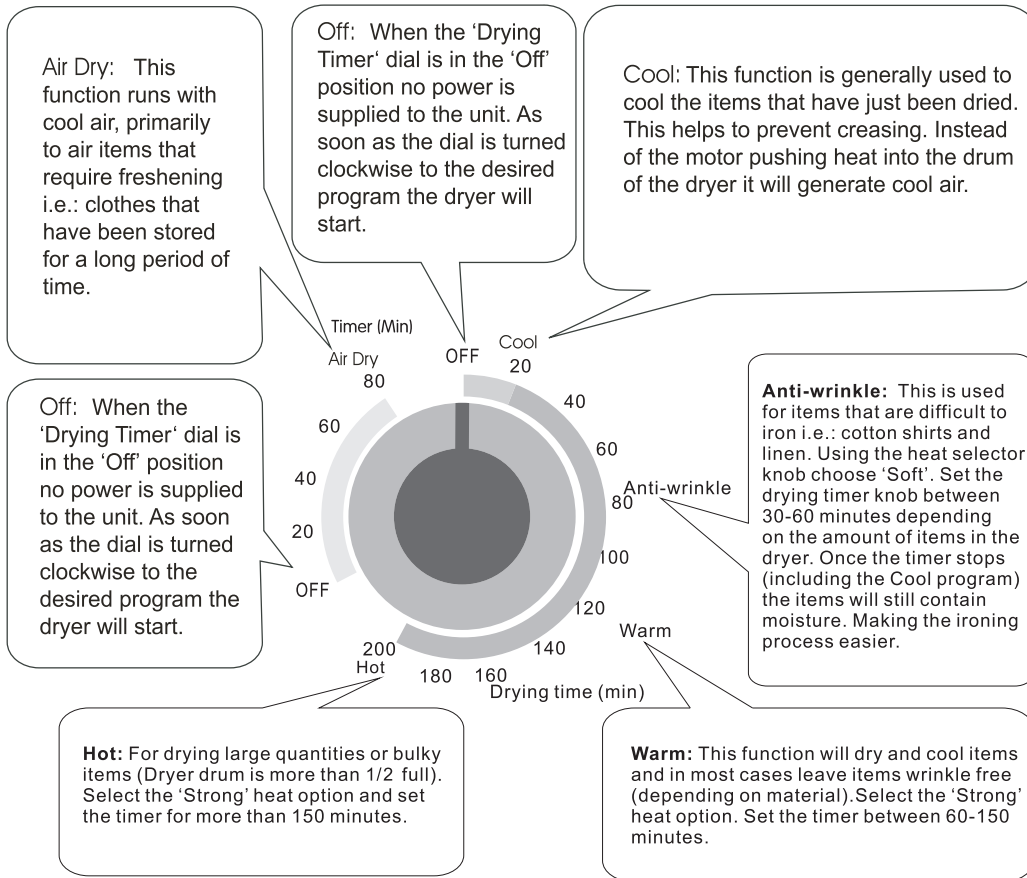

## ➤ DRY MODE SELECTOR

This unit is designed with an automatic moisture sensor to monitor the moisture level of the clothes for optimistic performance. It provides you both **Auto Dry** and **Timed Dry** modes for your best drying performance.



### Auto Dry Mode:

When the Auto Dry Mode function button to be selected, the energy program starts to operate; The timer twist to the working position of 200 mins, the machine running according to the following procedures: firstly begin to run cold air for 135 minutes, hot air to run for 22 minutes, finally back to the machine running cold air. The machine will stop working till the timer stops working.

**Note:** For heavy items like jeans, blankets, covers, towels, etc., recommended mode is timed dry.

### Timed Dry Mode:

When the selector button is pressed down, unit will work under timer controlled mode. Set the timer with the following references:

## ➤ DRYING TIME REFERENCE

**\*\* LOAD WEIGHTS AND RESPECTIVE DRYING TIMES ARE APPROXIMATE \*\***

Drying Capacity	Drying Times	
	High Heat	Low Heat
3 (Three) Lbs	30 Minutes	55 Minutes
5 (Five) Lbs	60 Minutes	110 Minutes
7 (Seven) Lbs	120 Minutes	
9 (Nine) Lbs	200 Minutes	

### Sorting Fabrics

For the best drying results, clothes should be sorted properly. Separate the lint shedders (chenille and terry cloth) from the lint collectors (synthetics, flannel and fabrics with a nap, such as velveteen and corduroy). Separate non-colorfast from light colored items, heavy fabrics from light weight fabrics and permanent press from heavy, bulky items.

Do not tumble dry

Read all permanent care labels carefully. If a garment's care label says "Drip Dry", Line Dry or "Dry Flat", do not dry in the dryer. Certain materials will melt or become dangerously flammable if heated, while others may lose their shape. Other items that should not be tumble dried are:

- Items that have been dry-cleaned at home.
- Wool (unless the garment's manufacturer recommends it)
- Fiberglass
- Laminated or rubber coated items
- Vinyl or plastic
- Do not use fabric softeners or products to eliminate static unless recommended by manufacturer of the fabric softener or product.

### **WARNING:**

**To reduce the risk of fire, electric shock, or injury to persons, read the IMPORTANT SAFETY INSTRUCTIONS before operating this appliance.**

#### Drying Time

Drying time depends on many factors, such as the amount of washing, how damp it is, the type of fabrics, rated power of the machine and the temperature of the room. It also, of course, depends on how dry you want the washing when you take it out of the machine.

#### Shrinkage

Knitted fabrics in particular are liable to shrink. Do not use the extra dry program for these materials, and always stretch them out directly after drying.

#### Dryer Added Fabric Softeners

Because some dryer added fabric softeners may cause damage to automatic dryers, use only ones that the manufacturers give a written assurance that their softeners can safely be used in your dryer.

#### Single Items

Use the timed program when there is only one item to be dried. This is because the automatic program may turn off the heating too early, so that the item is not properly dried.

#### If The Washing Is Not Dry After Tumble-Drying

























When using the automatic programs, it can happen that not all of the washing is properly dry. This may be due

to such reasons as very heavy fabrics or thick seams. To dry these items, give a further 10 minutes or so in the timed program. Also do not overload the dryer. If the dryer is overloaded, its efficiency is lessened and clothes may not dry evenly.

**Do not over-dry**

When using the timed program, it is possible to over-dry fabrics, if too long a time has been set. This can cause the fabrics to wrinkle, shrink or feel harsh. Synthetic materials can also become charged with static electricity.

**Fabric Care Chart**

	Resistant material		Can be ironed at 100°C max
	Delicate fabric		Do not iron
	Item may be washed at 95°C		Can be dry cleaned using any solvent
	Item may be washed at 60°C		Dry clean with perchloride, lighter fuel, pure alcohol or R113 only
	Item may be washed at 40°C		Dry clean with aviation fuel, pure alcohol or R113 only
	Item may be washed at 30°C		Do not dry clean
	Item may be hand washed		Dry flat
	Dry clean only		Can be hung to dry
	Can be bleached in cold water		Dry on clothes hanger
	Do not bleach		Tumble dry, normal heat
	Can be ironed at 200°C max		Tumble dry, reduced heat
	Can be ironed at 150°C max		Do not tumble dry

CARE AND MAINTENANCE

➤ **Cleaning the Exterior**

- Wipe the dryer surfaces, including the control panel, with a soft cloth and non-abrasive household detergents.
- Use a soft cloth to dry the surfaces.
- Do not pour water on the dryer.

➤ **Cleaning the Filters**

**Unplug the power cord prior to any cleaning.**

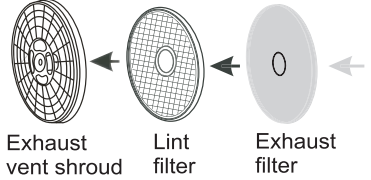
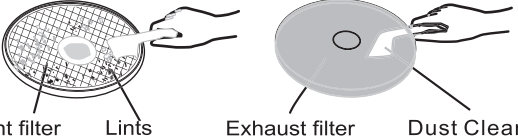
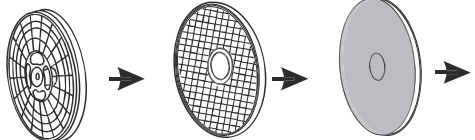
Cleaning the Lint Filter:	
a)	<p>Removing the Lint Filters: Remove by pulling outward using the four (4) grip holes in the filter assembly.</p> <p>ALL FILTERS MUST BE IN PLACE WHEN DRYING  FILTERS MUST BE CLEANED BEFORE AND AFTER EACH USE.</p>
b)	<p>The filter assembly consists of three (3) parts (See illustration) a) Exhaust Vent Shroud b) Lint Filter c) Exhaust Filter</p>  <p>Exhaust vent shroud      Lint filter      Exhaust filter</p>
c)	<p>Separate each of the above parts and clean the individual pieces using a SOFT brush or vacuum cleaner. DO NOT damage the filters</p>  <p>Lint filter      Lints      Exhaust filter      Dust Clean</p>
d)	<p>Re-install the filter assembly Reassemble the filter assembly in order Exhaust Filter – Lint Filter – Exhaust Shroud Align the entire assembly with the recessed position in the back of the drum and press firmly until the entire assembly is secure.</p>  <p style="text-align: right;">Figure 3</p>

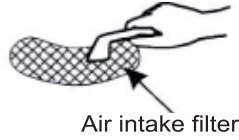
Cleaning the Air Intake Filter	
a)	<p>Removing the Air Intake Filter: Remove by pulling outward holding the filter housing by the top and bottom.</p> 
b)	<p>Remove the filter inside the housing and clean using a SOFT brush or vacuum cleaner.</p>  <p style="text-align: center;">Air intake filter</p>
c)	<p>Replace the filter housing by pushing upwards with your thumb until the latch is secure.</p>

## PROBLEMS WITH YOUR DRYER?

You can solve many common appliance problems easily, saving you the cost of a possible service call. Try the suggestions below to see if you can solve the problem before calling the servicer.

### TROUBLESHOOTING GUIDE

PROBLEM	POSSIBLE CAUSE
Timer knob will not rotate Dryer does not operate. Drum does not rotate	Not plugged in. The circuit breaker tripped or blown fuse. Door is not closed.
Laundry not completely dry	Clean the Filter Reduce the amount of clothing loaded in the dryer. Re-dry the loaded items Ensure items are not knotted or bulked together. Dryer is not located in a well ventilated area.

## SERVICE FOR YOUR DRYER

We are proud of our customer service organization and the network of professional service technicians that provide service on your Avanti appliances. With the purchase of your Avanti dryer, you can have the confidence that if you ever need additional information or assistance, the Avanti Products Customer Service team will be here for you. Just call us toll-free.

### AVANTI PRODUCTS CUSTOMER SERVICES

Product Information 800-323-5029	Whatever your questions are about our products, help is available.
Part Orders 800-220-5570	You may order parts and accessories that will be delivered directly to your home. You may order these items by personal check, money order, Master Card, or Visa.
In-Home Repair Service 800-220-5570	An Avanti Products authorized service center will provide expert repair service, scheduled at a time that is convenient for you. Our trained servicers know your dryer inside and out.



**YOUR AVANTI PRODUCTS  
WARRANTY**

Staple your sales receipt here. Proof of original purchase date is needed to obtain service under warranty.

**WHAT IS COVERED – LIMITED ONE-YEAR WARRANTY**

Avanti Products warrants that the product is free from defects in materials and/or workmanship for a period of twelve (12) months from the date of purchase by the original owner. The foregoing timeline begins to run upon the date of purchase, and shall not be stalled, tolled, extended, or suspended for any reason whatsoever unless described in detail in the warranty document. For one year from the date of purchase by the original owner, Avanti products will, at its option, repair or replace any part of the product which proves to be defective in material or workmanship under normal use. Avanti Products will provide you with a reasonably similar product that is either new or factory refurbished. During this period Avanti Products will provide all parts and labor necessary to correct such defects free of charge, so long as the product has been installed and operated in accordance with the written instructions in this manual. In rental or commercial use, the warranty period is 90 days. All Avanti appliances of 4.1 cubic feet capacity or less must be brought/sent to the appliance service center for repair.

**LIMITED FIVE YEAR WARRANTY ON PLASTIC TUB (CLOTHES WASHERS ONLY)**

After one year and until five years from the date of purchase, Avanti Products will furnish a replacement plastic tub, for one which is defective in material or workmanship. All labor and transportation charges are the responsibility of the consumer.

**LIMITED SEVEN YEAR WARRANTY ON STAINLESS STEEL TUB (Clothes Washer And Dryer)**

After one year and until seven years from the date of purchase, Avanti Products will furnish a replacement tub, for one which is defective in material or workmanship. All labor and transportation charges are the responsibility of the consumer.

**WARRANTY EXCLUSIONS / WHAT IS NOT COVERED:**

The warranty coverage described herein excludes all defects or damage that are not the direct fault of Avanti Products, including without limitation, one or more of the following:

- A failure to comply with any applicable state, local, city, or county electrical, plumbing and/or building codes, regulations, or laws, including failure to install the product in strict conformity with local fire and building codes and regulations.
- Any external, elemental and/or environmental forces and factors, including without limitation, rain, wind, sand, floods, fires, mud slides, freezing temperatures, excessive moisture or extended exposure to humidity, lightning, power surges, structural failures surrounding the appliance, and acts of God.

- Incidental or consequential damages
- Parts and labor costs for the following will not be considered as warranty:
  - Inner door panels, door shelves, door rails, and/or door supports.
  - Light bulbs and/or plastic housing.
  - Plastic cabinet liners.
- Failure of the product if it is used for other than its intended purpose.
- Shipping and handling costs associated with the replacement of the unit.

- Repairs performed by unauthorized servicers.
- Service calls that are related to external problems, such as abuse, misuse, inadequate electrical power, accidents, fire, floods, or any other acts of God.
- Surcharges including but not limited to, any after hour, weekend, or holiday service calls, tolls, ferry trip charges, or mileage expense for service calls to remote areas.
- The warranty does not apply outside the Continental USA.

In no event shall Avanti Products have any liability or responsibility whatsoever for damage to surrounding property, including cabinetry, floors, ceilings, and other structures and/or objects around the product. Also excluded from this warranty are scratches, nicks, minor dents, and other cosmetic damages on external surfaces and exposed parts; Products on which the serial numbers have been altered, defaced or removed; service visits for customer education, or visits where there is nothing wrong with the product; correction of installation problems (you are solely responsible for any structure and setting for the product, including all electrical, plumbing and/or other connecting facilities, for proper foundation/flooring, and for any alterations including without limitation cabinetry, walls, floors, shelving etc., as well as the resetting of breakers or fuses.

**OUT OF WARRANTY PRODUCT**

Avanti Products is under no obligation, at law or otherwise, to provide you with any concessions, including repairs, pro-rates, or product replacement, once this warranty has expired.

*Warranty – Laundry Products*



## Registration Information

Thank you for purchasing this fine Avanti product. Please fill out this card and return it within 100 days of purchase and receive these important benefits:

➤ **Protect your product:**

We will keep the model number and date of purchase of your new Avanti product on file to help you refer to this information in the event of an insurance claim such as fire or theft.

➤ **Promote better products:**

We value your input. Your responses will help us develop products designed to best meet your future needs.

------(detach here)-----

### Avanti Registration Card

Name _____			Model # _____	Serial # _____
Address _____			Date Purchased _____	Store/Dealer Name _____
City _____	State _____	Zip _____	Occupation _____	
Area Code _____	Phone Number _____		<b><u>As Your Primary Residence, Do You:</u></b> <input type="checkbox"/> Own <input type="checkbox"/> Rent	

**Did You Purchase An Additional Warranty:**

Extended       None

**Reason For Choosing This Avanti Product:**

Please indicate the most important factors that influenced your decision to purchase this product.

- Price
- Product Features
- Avanti Reputation
- Product Quality
- Salesperson Recommendation
- Friend/Relative Recommendation
- Warranty
- Other \_\_\_\_\_

**Your Age:**

under 18     18-25     26-30  
 31-35     36-50     over 50

**Marital Status:**

Married       Single

**Is This Product Used In The:**

Home       Business

**How Did You Learn About This Product:**

Advertising       Product Features  
 In Store Demo       Personal Demo  
 Other \_\_\_\_\_

Comments \_\_\_\_\_  
\_\_\_\_\_  
\_\_\_\_\_

D110J2P-IS- 12222017

PRINTED IN CHINA