



Chill Premier Inverter[®] Series Room Air Conditioners R-32 Refrigerant



Fixed Chassis, Cool Only

CCV08A10A, CCV10A10A, CCV12A10A

TABLE OF CONTENTS

Table of Contents

INTRODUCTION	4
Important Safety Information	4
Personal Injury or Death Hazards	6
SPECIFICATIONS	8
Refrigeration Systems Performance Data	8
Compressor Performance Data	8
Dimensions	9
Electrical Data	10
OPERATION	11
Control Panel	11
Remote Control	14
General Knowledge Sequence Of Refrigeration	17
Sequence of Operation	18
Refrigeration Sequence Of Operation	22
TROUBLESHOOTING	23
Fault Codes	23
E0 Display PCB & Main PCB communication failure	25
E1, E2 (Room temperature sensor and/or Indoor Coil Temperature Sensor Failure)	26
E6 Indoor ventilation failure	27
E3, E7 or E8 Outdoor Coil temperature sensor, Ambient temperature sensor or Discharge temperature sensor failure.	28
E9 IPM /Compressor Drive Fault	29
EF Outdoor DC fan motor failure	30
EU voltage test sensor failure	31
P0 IPM protection	32
P1 Over / under voltage protection	33
P2 Over Current protection	34
P4 Exhaust Air temperature overheating protection	35
P5 Sub-cooling protection on Cooling/Dry mode	36
P6 Overheating protection on Cooling mode	37
P7 Overheating protection on Cooling mode	38
P8 Exhaust Air Overtemperature/Under temperature protection	39
P9 The compressor driving protection (the compressor load abnormal)	40
F5 PFC Protection	41
F6 The Compressor Lack of phase / Anti phase protection.	42
F7 IPM Module temperature protection.	43
Check Thermistors	44
Undercharged Refrigerant Systems	46
Overcharged Refrigerant Systems	47
Restricted Refrigerant System	48
COMPONENT TESTING	49
Check Capillary Tube	49
Main PCB Identification	51
Display PCB Identification	52
UNIT DISSASSEMBLY	53
Replace Display PCB and Assembly	56
Replace Main PCB	58
R-32 SEALED SYSTEM REPAIR	61
General Information	61
Required Equipment	63
Refrigerant Removal, Recovery, and Evacuation	64
Component Replacement/Brazing	65
Refrigerant Charging	66
Compressor Replacement	68
Compressor Replacement -Special Procedure in Case of Compressor Burnout	69

TABLE OF CONTENTS

WIRING DIAGRAMS	70
Appendix 1 Resistance Table of Thermistors (5K)(Ambient and Coil Sensors)	71
Appendix 2 Resistance Table of Thermistors (20K)(Compressor Discharge Sensor)	72
Appendix 3 Decommissioning Of Units	73
FRIEDRICH AUTHORIZED PARTS DEPOTS	75

INTRODUCTION

Important Safety Information

The information in this manual is intended for use by a qualified technician who is familiar with the safety procedures required for installation and repair, and who is equipped with the proper tools and test instruments required to service this product.

Installation or repairs made by unqualified persons can result in subjecting the unqualified person making such repairs as well as the persons being served by the equipment to hazards resulting in injury or electrical shock which can be serious or even fatal.

Safety warnings have been placed throughout this manual to alert you to potential hazards that may be encountered. If you install or perform service on equipment, it is your responsibility to read and obey these warnings to guard against any bodily injury or property damage which may result to you or others. This service manual is designed to be used in conjunction with the installation and operation manuals provided with each air conditioning system. This service manual was written to assist the professional service technician to quickly and accurately diagnose and repair malfunctions.

Installation procedures are not given in this manual. They are given in the Installation/Operation manual which can be acquired on the Friedrich [website](#). Click the Link or scan the QR code to be directed to the Professional page where you can locate our technical literature.

IMPORTANT: It will be necessary for you to accurately identify the unit you are servicing, so you can be certain of a proper diagnosis and repair.

SAFETY IS IMPORTANT

We have provided many important safety messages in this manual and on your appliance. Always read and obey all safety messages.



This is a safety Alert symbol. This symbol alerts you to potential hazards that can kill or hurt you and others.

All safety messages will tell you what the potential hazard is, tell you how to reduce the chance of injury, and tell you what will happen if the instructions are not followed.

All safety messages will follow the safety alert symbol with the word "WARNING" or "CAUTION". These words mean:



WARNING

Indicates a hazard which, if not avoided, can result in severe personal injury or death and damage to product or other property.



CAUTION

Indicates a hazard which, if not avoided, can result in personal injury and damage to product or other property.

NOTICE

Indicates property damage can occur if instructions are not followed.



This symbol indicates that this appliance uses a flammable refrigerant. If the refrigerant is leaked and is exposed to an external ignition source, there is a risk of fire.



This symbol indicates that the Operation Manual should be read carefully.



This symbol indicates that service personnel should be handling this equipment with reference to the installation manual.



This symbol indicates that information is available such as the Installation and Operation manual, or the Service Manual.

INTRODUCTION

⚠️ WARNING: The manufacturer's warranty does not cover any damage or defect to the air conditioner caused by the attachment or use of any components, accessories or devices (other than those authorized by the manufacturer) into, onto or in conjunction with the air conditioner. You should be aware that the use of unauthorized components, accessories or devices may adversely affect the operation of the air conditioner and may also endanger life and property. The manufacturer disclaims any responsibility for such loss or injury resulting from the use of such unauthorized components, accessories or devices.

⚠️ WARNING: This appliance is not intended for use by persons (including children) with reduced physical, sensory or mental capabilities, or lack of experience and knowledge, unless they have been given supervision or instruction concerning use of the appliance by a person responsible for their safety.

Children should be supervised to ensure that they do not play with the appliance.

⚠️ WARNING: The maximum altitude for this appliance is 2,000 meters(6,562 feet).

Do not use above 2,000 meters(6,562 feet).

⚠️ WARNING: Electrical Shock Hazard

Disconnect all power to the unit before starting maintenance. All electrical connections and wiring **MUST** be installed by a qualified electrician and conform to the National Code and all local codes which have jurisdiction. Failure to do so can result in property damage, severe electrical shock or death.



⚠️ WARNING: Read Installation Manual

Read this manual thoroughly prior to equipment installation or operation. It is the installer's responsibility to properly apply and install the equipment. Installation must be in conformance with the NFPA 70-2023 national electric code or current edition, International Mechanic code 2021 or current edition, and any other local or national codes.



⚠️ WARNING: Safety First

Do not remove, disable, or bypass this unit's safety devices. Doing so may cause fire, injuries, or death.

⚠️ WARNING: This Product uses R-32 Refrigerant

Do not use means to accelerate the defrosting process or to clean, other than those recommended by the manufacturer.

The appliance shall be stored in a room without continuously operating ignition sources (for example: open flames, an operating gas appliance or an operating electric heater.

Do not pierce or burn.

Be aware that refrigerants may not contain an odor.



**Refrigerant
Safety Group
A2L**

⚠️ WARNING: Refrigeration System under High pressure

Do not puncture, heat, expose to flame or incinerate. Only certified refrigeration technicians should service this equipment. R32 systems operate at higher pressures than R22 equipment. Appropriate safe service and handling practices must be used.



⚠️ CAUTION: Do Not Operate Equipment During Active Stages Of Construction



To ensure proper operation, Friedrich requires that all equipment is not operated during active construction phases. This includes active stages of completing framing, drywalling, spackling, sanding, painting, flooring, and moulding in the equipment's designated conditioning space. The use of this equipment during construction could result in premature failure of the components and/or system and is in violation of our standard warranty guidelines. The operation of newly installed equipment during construction will accelerate the commencement and/or termination of the warranty period.

⚠️ WARNING: Keep all air circulation and ventilation openings free from obstruction.

⚠️ WARNING: The unit should not be in contact with any equipment that will transmit vibration to the unit. Any excessive vibration or pulsation to the unit could result in damage to the refrigerant tubing.

INTRODUCTION

Personal Injury or Death Hazards

SAFETY FIRST	 WARNING	 AVERTISSEMENT	 ADVERTENCIA
		Do not remove, disable or bypass this unit's safety devices. Doing so may cause fire, injuries, or death.	Ne pas supprimer, désactiver ou contourner cette l'unité des dispositifs de sécurité, faire vous risqueriez de provoquer le feu, les blessures ou la mort.

 WARNING
ALWAYS USE INDUSTRY STANDARD PERSONAL PROTECTIVE EQUIPMENT (PPE)

ELECTRICAL HAZARDS:

- Unplug and/or disconnect all electrical power to the unit before performing inspections, maintenance, or service.
- Make sure to follow proper lockout/tag out procedures.
- Always work in the company of a qualified assistant if possible.
- Capacitors, even when disconnected from the electrical power source, retain an electrical charge potential capable of causing electric shock or electrocution.
- Handle, discharge, and test capacitors according to safe, established, standards, and approved procedures.
- Extreme care, proper judgment, and safety procedures must be exercised if it becomes necessary to test or troubleshoot equipment with the power on to the unit.
- Do not spray water on the air conditioning unit while the power is on.
- Electrical component malfunction caused by water could result in electric shock or other electrically unsafe conditions when the power is restored and the unit is turned on, even after the exterior is dry.
- Use air conditioner on a single dedicated circuit within the specified amperage rating.
- Use on a properly grounded outlet only.
- Do not cut or modify the power supply cord or remove the ground prong of the plug.
- Never operate the unit on an extension cord.
- Follow all safety precautions and use proper and adequate protective safety aids such as: gloves, goggles, clothing, properly insulated tools, and testing equipment etc.
- Failure to follow proper safety procedures and/or these warnings can result in serious injury or death.

INTRODUCTION

Personal Injury Or Death Hazards

- **REFRIGERATION SYSTEM REPAIR HAZARDS:**
 - Use approved standard refrigerant recovering procedures and equipment to relieve high pressure before opening system for repair.
 - Do not allow liquid refrigerant to contact skin. Direct contact with liquid refrigerant can result in minor to moderate injury.
 - Be extremely careful when using an oxy-acetylene torch. Direct contact with the torch's flame or hot surfaces can cause serious burns.
 - Make certain to protect personal and surrounding property with fire proof materials and have a fire extinguisher at hand while using a torch.
 - Provide adequate ventilation to vent off toxic fumes, and work with a qualified assistant whenever possible.
 - Always use a pressure regulator when using dry nitrogen to test the sealed refrigeration system for leaks, flushing etc.
- **MECHANICAL HAZARDS:**
 - Extreme care, proper judgment and all safety procedures must be followed when testing, troubleshooting, handling, or working around unit with moving and/or rotating parts.
 - Be careful when, handling and working around exposed edges and corners of the sleeve, chassis, and other unit components especially the sharp fins of the indoor and outdoor coils.
 - Use proper and adequate protective aids such as: gloves, clothing, safety glasses etc.
 - Failure to follow proper safety procedures and/or these warnings can result in serious injury or death.
- **PROPERTY DAMAGE HAZARDS**
- **FIRE DAMAGE HAZARDS:**
 - Read the Installation/Operation Manual for the air conditioning unit prior to operating.
 - Use air conditioner on a single dedicated circuit within the specified amperage rating.
 - Connect to a properly grounded outlet only.
 - Do not remove ground prong of plug.
 - Do not cut or modify the power supply cord.
 - Do not use extension cords with the unit.
 - Be extremely careful when using acetylene torch and protect surrounding property.
 - Failure to follow these instructions can result in fire and minor to serious property damage.
- **WATER DAMAGE HAZARDS:**
 - Improper installation, maintenance or servicing of the air conditioner unit can result in water damage to personal items or property.
 - Insure that the unit has a sufficient pitch to the outside to allow water to drain from the unit.
 - Do not drill holes in the bottom of the drain pan or the underside of the unit.
 - Failure to follow these instructions can result in damage to the unit and/or minor to serious property damage.

SPECIFICATIONS

Refrigeration Systems Performance Data

Model	Cooling Btu	Volts Rated	Cooling Amps	Cooling Watts	EER	CEER	Moisture Removal- Pints/HR	Refrigerant	Refrigerant Charge g/ oz	Indoor Airflow CFM Low/ Med/ Hi	Outdoor Airflow CFM Low/ Med/ Hi	Weight Net./ Ship lbs.
FIXED CHASSIS, COOL ONLY (WINDOW INSTALLATION ONLY)												
CCV08A10A	8000	115	8	740		15	2.11	R-32	280/9.88	194/165/147	430/359/294	56.2/ 59.5
CCV10A10A	10000	115	8	950		15	3.17	R-32	300/ 10.58	253/195/135	430/359/294	57.8/ 61.1
CCV12A10A	12000	115	11	1180		15	3.69	R-32	330/ 11.64	265/195/147	430/359/294	58.2/ 61.5

Figure 201

Compressor Performance Data

Model	Type	Brand	Capacity BTU/h	Refrigerant Oil (ml)
FIXED CHASSIS, COOL ONLY (WINDOW INSTALLATION ONLY)				
CCV08A10A	Rotary	GMCC	9468	240
CCV10A10A	Rotary	GMCC	9468	240
CCV12A10A	Rotary	GMCC	9468	240

Figure 202

SPECIFICATIONS

Dimensions

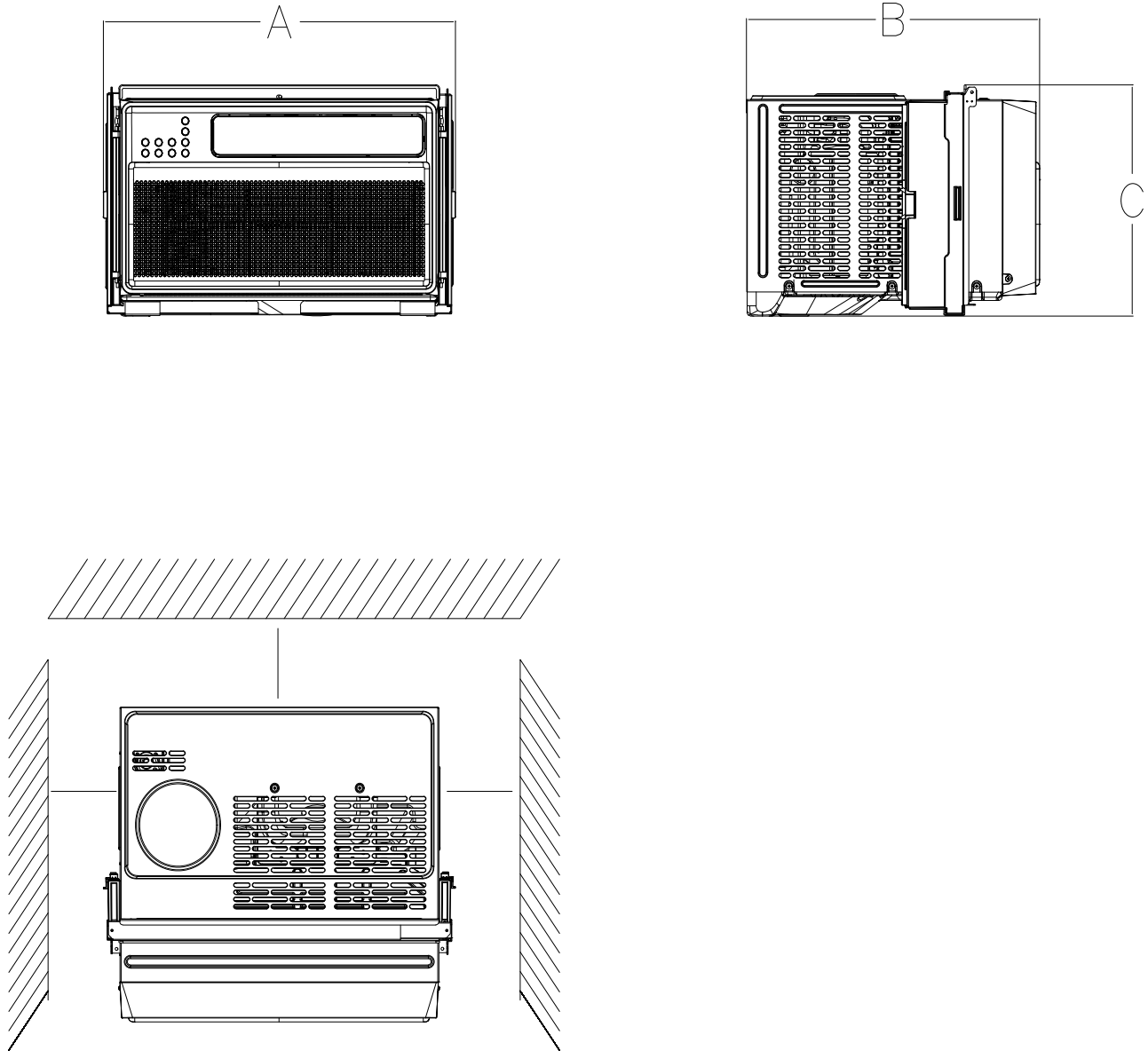

Model	A"	B"	C"	Minimum Window Width"	Maximum Window Width"	Minumun Window Height"
CCV08A10A	20 ⁵ / ₈	19 ¹ / ₄	13 ³ / ₈	24	36	14 ¹ / ₂
CCV10A10A	20 ⁵ / ₈	19 ¹ / ₄	13 ³ / ₈	24	26	14 ¹ / ₂
CCV12A10A	20 ⁵ / ₈	19 ¹ / ₄	13 ³ / ₈	24	36	14 ¹ / ₂

Figure 203

SPECIFICATIONS

Electrical Data

WARNING	
	<p>ELECTRIC SHOCK HAZARD</p> <p>Turn off electric power before service or installation.</p> <p>All electrical connections and wiring MUST be installed by a qualified electrician and conform to codes which have jurisdiction.</p> <p>Failure to do so can result in personal injury or death.</p>

NOTICE
<p style="text-align: center;">FIRE HAZARD</p> <p>Not following the above WARNING could result in fire or electrically unsafe conditions which could cause moderate or serious property damage.</p> <p>Read, understand and follow the above warning.</p>

Model	Circuit Rating Breaker or T-D Fuse	Plug Face (NEMA#)	Power Cord Length (ft.)	Wall Outlet Appearance
<p>CCV08A10A CCV10A10A CCV12A10A</p>	125V-15A	5-15P	5	

Figure 204 (Circuit Breaker / Plug / Receptacle / Cord Rating)

Wire Size - Use ONLY wiring size recommended for single outlet branch circuit.

Fuse/ Circuit Breaker - Use ONLY the correct HACR type and size fuse/circuit breaker. Read electrical ratings on unit's rating plate. Proper circuit protection is the responsibility of the homeowner.

Grounding - Unit **MUST** be grounded from branch circuit through service cord to unit, or through separate ground wire provided on permanently connected units. Be sure that branch circuit or general purpose outlet is grounded.

Receptacle - The field supplied outlet must match plug on service cord and be within reach of service cord. Do NOT alter the service cord plug. Do NOT use an extension cord. Refer to the table above for proper receptacle and fuse type.

Make sure the wiring is adequate for your unit.
All Wiring should meet all national and local codes and ordinances.

If you have fuses, they should be of the time delay type. Before you install or relocate this unit, be sure that the amperage rating of the circuit breaker or time delay fuse does not exceed the amp rating listed in Table 206.

DO NOT use an extension cord.

The cord provided will carry the proper amount of electrical power to the unit; an extension cord may not.

Make sure that the receptacle is compatible with the air conditioner cord plug provided.

Proper grounding must be maintained at all times. Two prong receptacles must be replaced with a grounded receptacle by a certified electrician.

The grounded receptacle should meet all national and local codes and ordinances. You must use the three prong plug furnished with the air conditioner. Under no circumstances should you remove the ground prong from the plug.

WARNING	
	<p>Electrical Shock Hazard</p> <p>Make sure your electrical receptacle has the same configuration as your air conditioner's plug. If different, consult a Licensed Electrician.</p> <p>Do not use plug adapters.</p> <p>Do not use an extension cord.</p> <p>Do not remove ground prong. Always plug into a grounded 3 prong outlet.</p> <p>Failure to follow these instructions can result in death, fire, or electrical shock.</p>

or

OPERATION



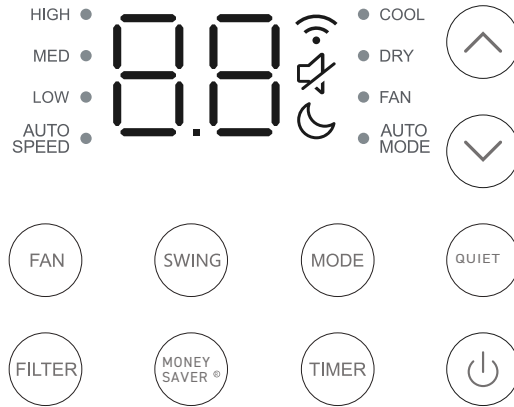



Control Panel



	Power	Turn on the air conditioner or switch to standby.
	Fan Speed	Adjust fan speed (Low, Med, High, Auto) NOTE: Fan speed setting is available in Auto, Cool, and Fan modes only.
	Swing/ Oscillation	Select to adjust the airflow direction by swinging the louver vertically.
	Decrease	Decrease the air conditioning temperature.
	Increase	Increase the air conditioning temperature.
		Switch between Cool/Dry/Fan/Auto mode.
		Remind to clean the dust filter.
		Turn on/off the ECO mode, under Cool/Dry mode.
		Timer on or Timer off the unit.
		Turn on/off the MUTE mode.
COOL DRY FAN AUTO MODE		Indicates Cool, Dry, Fan, and Auto mode, respectively.
		Indicates the unit is in Sleep mode.
		Indicates the unit is in MUTE mode.
		Indicates that there is a WiFi connection
HIGH MED LOW AUTO SPEED		Indicates Low, Medium, High, and Automatic fan speeds, respectively.

OPERATION

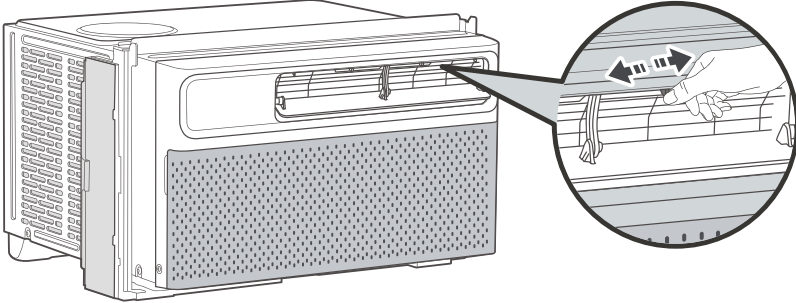
Control Panel

 <p>Power Button</p>	<p>Press to turn on the air conditioner or switch it to standby mode.</p>
 <p>Increase Button</p>	<p>Press to increase the air conditioning temperature by 1°F/°C.</p>
 <p>Decrease Button</p>	<p>Press to decrease the air conditioning temperature by 1°F/°C.</p>
 <p>Swing/ Oscillation Button</p>	<p>1. Press to make the louver move up and down. 2. Press again to stop the louver at the desired angle. NOTE: To adjust the airflow direction horizontally, manually move the levers located on top of the air outlet from side to side.</p> <p>NOTE: Do not adjust the big horizontal louver by hand, otherwise will cause damage.</p> 
 <p>Fan Speed Button</p>	<p>Adjust Fan Speed Press repeatedly to adjust fan speed: Low, Med, High, and Auto. Reset Filter Reminder To clean the filter, see Routine Maintenance.</p>

NOTE:

- In Auto speed, fan speed will adapt to the room temperature.
- In Dry Mode, fan speed cannot be adjusted.

OPERATION

Control Panel

 <p>Mode Button</p>	<p>Press repeatedly to cycle through Cool, Dry, Fan and Auto modes.</p> <p>Cool Mode</p> <ul style="list-style-type: none">- In Cool mode, the air conditioner cools the room to the desired temperature.- Temperature and fan speed are adjustable. <p>Dry Mode</p> <ul style="list-style-type: none">- In Dry mode, the air conditioner works as a dehumidifier to remove humidity in the room. The fan is constantly running at a low speed.- Temperature and fan speed cannot be adjusted, <p>Fan Mode</p> <ul style="list-style-type: none">- In Fan mode, the air conditioner circulates air like a normal fan. Remember to open the vent during this function, but keep it closed during cooling for maximum cooling efficiency- Fan speed can be set to Low, med, or High.- Temperature cannot be adjusted. <p>Auto Mode</p> <p>Will adjust Cooling, Fan speed, & Vertical Louver (if activated) automatically based on the room temperature conditions. The set temperature can be adjusted from 61-88°F in auto mode, the operation of fan speed and vane position change according to the temperature setting.</p>
--	---

Other Features

Filter Reminder

When the running time of the fan reaches 500 hours, the filter reminder will light up to remind you to clean the filter.

Display Auto Off

- Display will dim after 30 seconds (off after 15 seconds in sleep mode).
- Wake up the display with any button.

Memory

If the air conditioner is turned OFF and stays connected to the power, it will operate under the previous settings (except the timer setting) when it is turned ON again.

Drain Water

After proper installation, condensate will not overflow during normal use.

If the sound of the condensate water hitting the fan blade is unpleasant and you dislike, it or is too loud; you can remove the drain cap located at the back of the air conditioner bottom right corner to drain away the water more quietly.

NOTE: Removing the cap may affect the heat transfer efficiency.

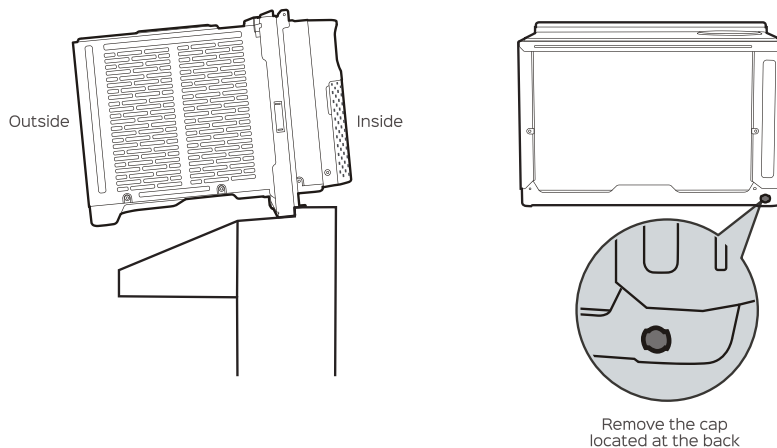

OPERATION

Remote Control

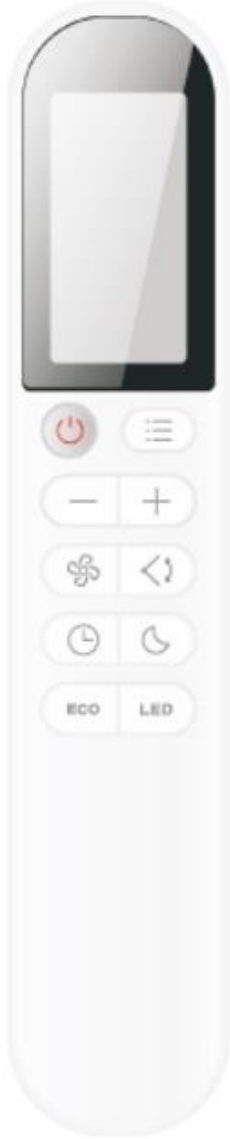

1. ON/OFF button

To switch the conditioner on and off.

2. MODE button

To select the mode of operation.

3. TEMP DOWN button

Decrease the temperature or time by 1 unit.

4. TEMP UP button

Increase the temperature or time by 1 unit.

5. FAN button

To select the fan speed of auto/low/mid/high , cycle as be low.

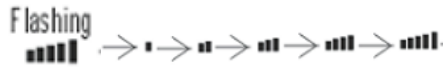

6. Up/Down SWING button

To activate the swing of horizontal flap(up/down) or deactivate it.

7. TIMER button

Press this button to activate/deactivate the TIMER function.

8. SLEEP button

Press this button to activate/deactivate the SLEEP function.

9. ECO button

Press this button to activate/deactivate the ECO function.

10. LED button

Press this button to activate/deactivate the DISPLAY function.

11. WIFI RESET (wifi restoration)

KEEP pressing "MODE" AND "+" together over 3 seconds.

12. Fahrenheit and Celsius one click toggle

Under boot state, long press the FAN button to switch between Fahrenheit and Celsius display



The look and function of remote control may be different.































































The shape and position of switches and indicators may be different according to the model, but their function is the same.

OPERATION





Remote Control

Meaning of symbols on the liquid crystal display.

1	 or  or AUTO	FEEL mode indicator
2	 or COOL	COOLING indicator
3	 or  or DRY	DEHUMIDIFYING indicator
4	 or FAN	FAN ONLY OPERATION indicator
5	 or 	SIGNAL RECEPTION indicator
6	 or  or  or  or 	TIMER OFF indicator
7	 or  or  or  or 	TIMER ON indicator
8	AUTO  or  or  or  or  or  or 	AUTO FAN indicator
9	 or  or  or  or  or  or 	LOW FAN SPEED indicator
10	 or  or  or  or  or  or 	MIDDLE FAN SPEED indicator
11	 or  or  or  or  or  or 	HIGH FAN SPEED indicator
12	QUIET  or  or  or  or 	SLEEP indicator
13	 or  or  or 	FLAP SWING indicator
14	 or ECO or 	ECO indicator
15	 or  or 	BATTERY indicator
16		Mute indicator

OPERATION

Remote Control

 <p>Sleep Mode Button (On Remote Control)</p>	<p>In Sleep mode, the air conditioning temperature will adjust gradually every 30 minutes to keep you comfortable while preventing overcooling. After 10 hours, Sleep mode will exit automatically and the temperature will return to the initial temperature.</p> <p>NOTE: In Sleep mode, all the button sounds will be muted, and all the indicators on the display will turn off after 15 seconds, except for the Sleep mode indicator.</p>
 <p>LED Display Button (On Remote Control)</p>	<ul style="list-style-type: none"> - Turn on or off the display on the air conditioner. - Long press 5 seconds to switch between °F/°C.
 <p>Timer Button (On Remote Control)</p>	<ul style="list-style-type: none"> - When the air conditioner is on standby/running, press the Timer button and its icon will flash on the remote display. During the flashing process, press + or - to select timer from 0.5 to 24 hours, then press the Timer button again to confirm the setting. After the timer ends, the air conditioner will start/stop running automatically. - Turning the air conditioner ON or OFF at anytime or adjusting the timer setting to 0.0 hour will cancel the timer program.
 <p>Eco Mode Button (On Remote Control)</p>	<p>In Eco mode, when the desired temperature is reached, the compressor will turn off and the fan will continue to run for 3 minutes. Then the fan cycles on from 1 to 5 minute intervals until the room temperature is above the set temperature, at which time the compressor turns back on and cooling restarts.</p>

OPERATION

General Knowledge Sequence Of Refrigeration

A good understanding of the basic operation of the refrigeration system is essential for the service technician. Without this understanding, accurate troubleshooting of refrigeration system problems will be more difficult and time consuming, if not (in some cases) entirely impossible. The refrigeration system uses four basic principles (laws) in its operation they are as follows:

1. "Heat always flows from a warmer body to a cooler body."
2. "Heat must be added to or removed from a substance before a change in state can occur"
3. "Flow is always from a higher pressure area to a lower pressure area."
4. "The temperature at which a liquid or gas changes state is dependent upon the pressure."

The refrigeration cycle begins at the compressor. Starting the compressor creates a low pressure in the suction line which draws refrigerant gas (vapor) into the compressor. The compressor then "compresses" this refrigerant vapor, raising its pressure and its (heat intensity) temperature.

The refrigerant leaves the compressor through the discharge Line as a hot High pressure gas (vapor). The refrigerant enters the condenser coil where it gives up some of its heat. The condenser fan moving air across the coil's finned surface facilitates the transfer of heat from the refrigerant to the relatively cooler outdoor air.

When a sufficient quantity of heat has been removed from the refrigerant gas (vapor), the refrigerant will "condense" (i.e. change to a liquid). Once the refrigerant has been condensed (changed) to a liquid it is cooled even further by the air that continues to flow across the condenser coil.

The design determines at exactly what point (in the condenser) the change of state (i.e. gas to a liquid) takes place. In all cases, however, the refrigerant must be totally condensed (changed) to a Liquid before leaving the condenser coil.

The refrigerant leaves the condenser Coil through the liquid line as a warm high pressure liquid. It next will pass through the refrigerant drier (if equipped). It is the function of the drier to trap any moisture present in the system, contaminants, and large particulate matter.

The liquid refrigerant next enters the metering device. The metering device is a capillary tube. The purpose of the metering device is to "meter" (i.e. control or measure) the quantity of refrigerant entering the evaporator coil. In the case of the capillary tube this is accomplished (by design) through size (and length) of device, and the pressure difference present across the device.

Since the evaporator coil is under a lower pressure (due to the suction created by the compressor) than the liquid line, the liquid refrigerant leaves the metering device entering the evaporator coil. As it enters the evaporator coil, the larger area and lower pressure allows the refrigerant to expand and lower its temperature (heat intensity). This expansion is often referred to as "boiling" or atomizing. Since the unit's blower is moving indoor air across the finned surface of the evaporator coil, the expanding refrigerant absorbs some of that heat. This results in a lowering of the indoor air temperature, or cooling.

The expansion and absorbing of heat cause the liquid refrigerant to evaporate (i.e. change to a gas). Once the refrigerant has been evaporated (changed to a gas), it is heated even further by the air that continues to flow across the evaporator coil.

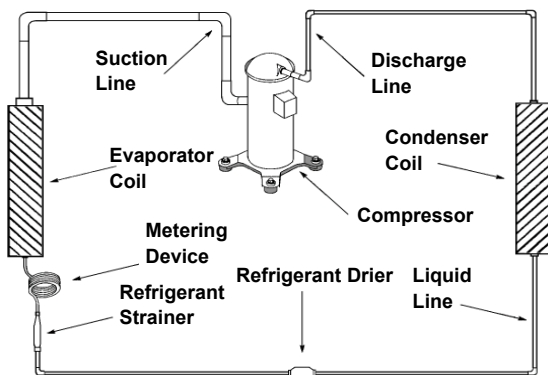

The particular system design determines at exactly what point (in the evaporator) the change of state (i.e. liquid to a gas) takes place. In all cases, however, the refrigerant must be totally evaporated (changed) to a gas before leaving the evaporator coil.

The low pressure (suction) created by the compressor causes the refrigerant to leave the evaporator through the suction line as a cool low pressure vapor. The refrigerant then returns to the compressor, where the cycle is repeated.

Figure 345 (Refrigeration Sequence Of Operation)

OPERATION

Sequence of Operation

Electronic controller

RT - Room Temperature.

IPT - Indoor Pipe (Coil) Temperature.

ST - Indoor Setting Temperature.

OPT - Outdoor Pipe Temperature.

OAT - Outdoor Ambient Temperature.

ODT - Outdoor Discharge Temperature.

Cooling mode. CRT=RT

1. Auto mode

1.1. The set temperature can be adjusted from 61-88°F in auto mode, the operation of fan speed and vane position change according to the temperature setting.

2. Cooling mode

2.1 Temperature control : The set temperature can be adjusted from 61-88°F in auto mode, the operation of fan speed and vane position change according to the temperature setting.

2.2. Compressor and process control.

2.2.1. When $RT-ST \geq 1^{\circ}F$, the compressor starts, AC operates according to the temperature setting.

2.2.2). When

2.2.2.1. $RT-ST \leq 5^{\circ}F$, compressor keeps 2 min continuously;

2.2.2.2 $RT-ST < 3.5^{\circ}F$, compressor works in lowest frequency for 5 min continuously;

2.2.2.3 $RT-ST < 2^{\circ}F$, compressor works in lowest frequency for 10 min continuously,

The compressor stops operation.

2.2.3. The compressor frequency control: Based on relation of RT & ST, and the changing speed of RT.

2.2.4. The compressor will also stop working while unit is:

a. switched off.

b. under protection.

c. changed to fan mode.

2.2.5. Under normal operation, the compressor can be stopped by program only after 7 min once it starts up.

2.2.6. Once the compressor is stopped by program, restart will be delayed for 3 minutes.

3. Outdoor Fan motor control:

3.1. While unit is:

3.1.1 switched off.

3.1.2 under protection.

3.1.3 to the set temperature.

After compressor shutdown, the fan motor stops working according to the temperature of OPT and OAT, the max delay for the motor should be less than 160s.

3.2. When the unit is switched on in cooling mode, outdoor fan motor will delay 5s after compressor starts up.

4. When Main PCB fails or stops for protection, Display PCB works as preset.

OPERATION

Sequence of Operation

5. Anti-frosting protection

Control the unit operation frequency and the frequency changing rate to achieve anti-frosting protection.

5.1 Frequency Slowly Increasing(FSI):

5.1.1 If $43^{\circ}\text{F} \leq \text{IPT} < 45^{\circ}\text{F}$, the frequency increasing rate is $1\text{Hz}/60\text{s}$, slowly increasing operation speed.

5.1.2 When $\text{IPT} \geq 7^{\circ}45^{\circ}\text{F}$, unit protection shuts down the unit.

5.2 Frequency Limitation:

If $41^{\circ}\text{F} \leq \text{IPT} < 43^{\circ}\text{F}$, the compressor frequency forbidden to increase.

5.3 Normal Frequency Decreasing (NFD):

If $37^{\circ}\text{F} \leq \text{IPT} < 39^{\circ}\text{F}$, the frequency decreasing rate is $8\text{Hz}/90\text{s}$, until reaching the lower frequency limit.

5.4 Fast Frequency Decreasing (FFD):

If $35^{\circ}\text{F} \leq \text{IPT} < 37^{\circ}\text{F}$, the frequency decreasing rate is $16\text{Hz}/90\text{s}$, until to the lower frequency limit.

5.5 Unit stop:

5.5.1 When $\text{IPT} < 34^{\circ}\text{F}$ for 3min continuously, unit stops working for anti-defrosting protection.

5.5.2 While $\text{IPT} < 42^{\circ}\text{F}$, and the unit stopped for 3 min already, can the unit recover to operation.

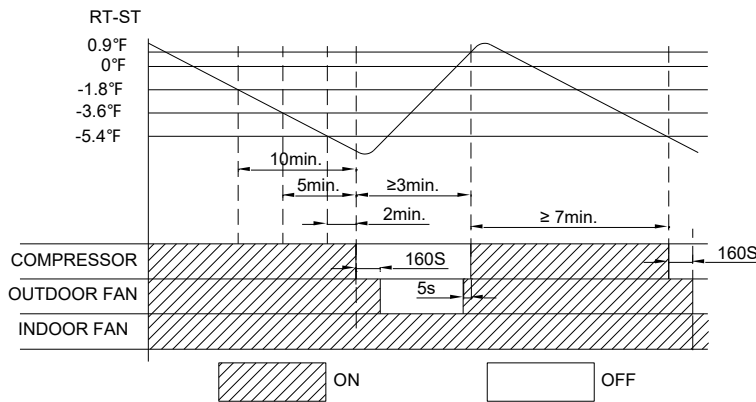

Figure 301

6. Dry mode

6.1 Temperature control: $61-88^{\circ}\text{F}$.

Fan speed: low Vane blade position: as selected.

6.2 When Main PCB fails or stops for protection, Display PCB works as preset.

6.3 Failure protection: as cooling mode.

6.4 Energy saving and sleep mode: Invalid.

6.5 Fan motor stops working.

6.6 Energy saving and sleep mode: Invalid.

7. Fan mode

7.1 The temperature setting: $61-88^{\circ}\text{F}$,

Fan speed and vane position: as preset.

7.2 For above function, when unit preset to be auto fan mode, the fan motor will change its operation speed based on the temperature difference of ambient and preset temperature.

7.3 Outdoor fan and compressor always OFF.

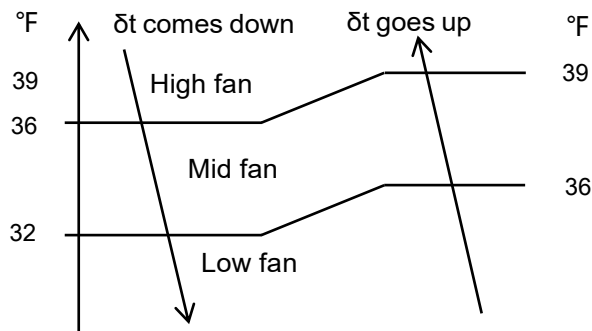

Figure 302

OPERATION

Sequence of Operation

8. Timer

The unit can be controlled by a timer. It will be switched on or off automatically.

8.1 TIMER ON

- 8.1.1 TIMER ON can be set only when the air conditioner is OFF.
- 8.1.2 Press TIMER on the remote control ONCE to enter time setting.
- 8.1.3 Press "+" or "-" to set the time for unit to start
- 8.1.4 Set other function as MODE, FAN SPEED, SWING etc.
- 8.1.5 Press TIMER ONCE AGAIN to confirm the TIME ON setting

8.2 TIMER OFF

- 8.2.1 TIMER OFF can be set only when the air conditioner is ON.
- 8.2.2 Press TIMER on the remote control ONCE to enter time setting.
- 8.2.3 Press "+" or "-" to set the time for unit to stop
- 8.2.4 Press TIMER ONCE AGAIN to confirm the TIME OFF setting

Note: In case of no selection for the time setting within 10s, the timer function will be OFF automatically.

9. Sleeping mode

While AC works in sleeping mode, the light of POWER SUPPLY and SLEEP always ON, and the temperature display will be OFF after 15s.

In this mode, the AC unit works according to the SLEEP CURVE as designed.

Sleeping mode the unit can work 10 hours continuously, after that it will quit from this mode and work as previous presetting.

10. Auto restart function

While unit is operating in one mode, all of its operation data, such as working mode, preset temperature etc., is memorized into IC by main PCB. If the unit lose power, the AUTO RESTART function will set synchronously and the air conditioner will work at the same mode as before once power is restored.

Note: The function setting: Within 3 min of turning the power on, set the unit in cooling mode, set temperature to 86°F, and mid fan speed, press the ECO button 10 times within 8s, the AUTO RESTART will be activated.

11. Over heat protection for Heating mode

11.1 Overload protection

11.1.1. Overload protection for Cooling or Dry mode

11.1.1.1 if:

- a. $OPT \geq 144^{\circ}\text{F}$, unit stops working for overload
- b. $OPT < 131^{\circ}\text{F}$, after compressor has stopped for 3 min, the unit can be restarted.

11.1.2 When $OPT \geq 131^{\circ}\text{F}$, the compressor will be frequency limited/reduced for over load protection.

11.1.3 If the unit faults 6 times for overload stop working protection continuously, this protection can't be recovered unless ON/OFF button is pressed,. The unit will show failure code.

In the process of operation, once the compressor runs continuously more than 6 min, the counter of overload stop working protection will be reset to zero and start a new counting process.

The failure protection will be reset when the unit is switched off or placed in fan mode.

NOTE: If the defective failure can't be recovered, the failure can't eliminate even if operation mode changed.

11.2 Overload protection for Heating mode

11.2.1 if:

- a. $IPT \geq 144^{\circ}\text{F}$, unit stops working for overload protection.
- b. $IPT < 131^{\circ}\text{F}$, after compressor stops for 3 min, the unit can be restarted.

11.2.2 When $IPT \geq 131^{\circ}\text{F}$, the compressor will be frequency limited/reduced for over load protection.

11.2.3 If unit has 6 times of over load stop-working protection continuously, this protection can't be recovered unless ON/OFF button is pressed, and unit will show failure code.

In the process of operation, once the compressor runs continuously more than 6 min, the counter of over load stop working protection will be reset to zero and start a new counting process.

The failure and times for protection will eliminate immediately once the unit to be switched off, on fan mode or changed to be heating mode from others.

Note: If the defective failure can't be recovered, the failure can't eliminate even if operation mode changed.

OPERATION

Sequence of Operation

12. The compressor discharge temperature protection

12.1. If $ODT \geq 239^{\circ}\text{F}$, unit stops working for over temperature protection.

While $ODT < 212^{\circ}\text{F}$, & after compressor stopped for 3 min, the unit can be restarted.

12.2 If $ODT \geq 212^{\circ}\text{F}$, the compressor will be frequency limited/reduced for over temperature protection.

12.3 If unit has a discharge over temperature stop working protection 6 times continuously, this protection can't be recovered unless ON/OFF button is pressed. The unit will show failure code.

In the process of operation, once the compressor runs continuously more than 6 min, the counter of discharge over temperature stop working protection will be reset to zero and start a new counting process.

The failure protection counter will be reset once the unit is switched off, or changed to fan mode.

13. The current protection

13.1 If the unit A/C working current is more than Limited current (ILC), the compressor will be frequency limited / reduced for over current protection.

13.2 When unit A/C working current is more than Stopped current (ISC), AC unit stops working. Only when the compressor stops for 3 min can the unit be restarted.

13.3 If unit faults 6 times for over current stop working protection continuously, the unit must be restarted to operate.

In the process of unit operation, once the compressor runs continuously more than 6 min, the counter of stop working protection will be reset to zero and re start a new counting process.

14. IPM overheating protection

14.1. When IPM temperature $T_{IPM} \geq 189^{\circ}\text{F}$, the compressor will be frequency limited / reduced for IPM over temperature protection.

14.2 When $T_{IPM} \geq 203^{\circ}\text{F}$, the AC unit stops working for AC system protection.

If $T_{IPM} 189^{\circ}\text{F}$, and after compressor stopped for 3 min, the unit can be restarted.

14.3. If unit faults 6 times for IPM over temperature stop working protection continuously, the unit will need to be restarted.

In the process of operation, once the compressor runs continuously more than 6 min, the counter of over load stop working protection will be reset to zero and re start a new counting process.

The failure and times for protection will reset once the unit is switched off, or changed to fan mode.

15. Complementary

15.1 ECO function is effective under cooling and heating mode only, and is enabled by default when unit is started up (even if the ECO function is disabled manually). It will not enable ECO function by default, if unit is started up by APP.

15.2 When the ECO function is set and the room temperature reaches the setting point, the indoor fan performs the following operation after the compressor stopping.

a. the indoor fan will be shut down after running for 3 minutes at the set speed.

b. If the compressor does not meet startup conditions, the indoor fan will stop within five minutes.

c. The indoor fan will resume operation at low speed for 1 minute after 5 minutes stop time.

d. The indoor fan will operate in cycle according to the order of b and c, before the compressor startup.

e. After the compressor meets the starting conditions, the indoor fan will exit the above cycle, and start running at the set speed immediately.

f. If the compressor does not meet the starting conditions after starting, the indoor fan runs at the set speed for 1 minute, and then cycles operation according to b and c. If the compressor start condition is reached after starting, the fan runs at the set speed.

h. The above logic will be not applied to the fault shutdown.

16. Communication control

If Main PCB can't get signal feedback from Display PCB for 2 min continuously, AC unit stops working and shows E0 error code as Main PCB/Display PCB communication failure. Once the Main PCB & Display PCB communication recovers, and the compressor has stopped for 3 minutes, can the unit be restarted.

17. Calibration Test Mode: Within 3 min while indoor unit switch on, and set the unit as:

17.1 Cooling mode.

17.2 set temperature to 30

17.3 Mid fan speed. Press ECO button 7 times within 8s, the unit will change to calibration test mode, and the buzzer sounds 3 times.

OPERATION

Refrigeration Sequence Of Operation

A good understanding of the basic operation of the refrigeration system is essential for the service technician. Without this understanding, accurate troubleshooting of refrigeration system problems will be more difficult and time consuming, if not (in some cases) entirely impossible. The refrigeration system uses four basic principles (laws) in its operation they are as follows:

1. "Heat always flows from a warmer body to a cooler body."
2. "Heat must be added to or removed from a substance before a change in state can occur"
3. "Flow is always from a higher pressure area to a lower pressure area."
4. "The temperature at which a liquid or gas changes state is dependent upon the pressure."

The refrigeration cycle begins at the compressor. Starting the compressor creates a low pressure in the suction line which draws refrigerant gas (vapor) into the compressor. The compressor then "compresses" this refrigerant vapor, raising its pressure and its (heat intensity) temperature.

The refrigerant leaves the compressor through the discharge Line as a hot High pressure gas (vapor). The refrigerant enters the condenser coil where it gives up some of its heat. The condenser fan moving air across the coil's finned surface facilitates the transfer of heat from the refrigerant to the relatively cooler outdoor air.

When a sufficient quantity of heat has been removed from the refrigerant gas (vapor), the refrigerant will "condense" (i.e. change to a liquid). Once the refrigerant has been condensed (changed) to a liquid it is cooled even further by the air that continues to flow across the condenser coil.

The design determines at exactly what point (in the condenser) the change of state (i.e. gas to a liquid) takes place. In all cases, however, the refrigerant must be totally condensed (changed) to a Liquid before leaving the condenser coil.

The refrigerant leaves the condenser Coil through the liquid line as a warm high pressure liquid. It next will pass through the refrigerant drier (if equipped). It is the function of the drier to trap any moisture present in the system, contaminants, and large particulate matter.

The liquid refrigerant next enters the metering device. The metering device is a capillary tube. The purpose of the metering device is to "meter" (i.e. control or measure) the quantity of refrigerant entering the evaporator coil.

In the case of the capillary tube this is accomplished (by design) through size (and length) of device, and the pressure difference present across the device.

Since the evaporator coil is under a lower pressure (due to the suction created by the compressor) than the liquid line, the liquid refrigerant leaves the metering device entering the evaporator coil. As it enters the evaporator coil, the larger area and lower pressure allows the refrigerant to expand and lower its temperature (heat intensity). This expansion is often referred to as "boiling" or atomizing. Since the unit's blower is moving indoor air across the finned surface of the evaporator coil, the expanding refrigerant absorbs some of that heat. This results in a lowering of the indoor air temperature, or cooling.

The expansion and absorbing of heat cause the liquid refrigerant to evaporate (i.e. change to a gas). Once the refrigerant has been evaporated (changed) to a gas, it is heated even further by the air that continues to flow across the evaporator coil.

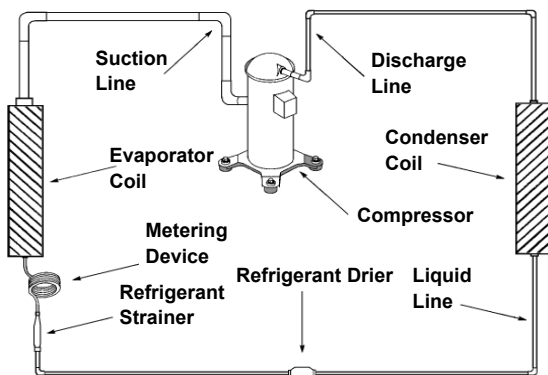

The particular system design determines at exactly what point (in the evaporator) the change of state (i.e. liquid to a gas) takes place. In all cases, however, the refrigerant must be totally evaporated (changed) to a gas before leaving the evaporator coil.

The low pressure (suction) created by the compressor causes the refrigerant to leave the evaporator through the suction line as a cool low pressure vapor. The refrigerant then returns to the compressor, where the cycle is repeated.

Figure 303 (Refrigeration Sequence Of Operation)

TROUBLESHOOTING

Fault Codes

Code	Reason	Remark
RT=Room Temperature NOTE: Always remove power from unit to reboot and see if fault clears before attempting to troubleshoot or repair.		
E0	Display and Main PCB Communication failure	Follow troubleshooting flow chart.
E1	Indoor Room Temperature sensor failure.	Follow troubleshooting flow chart.
E2	Indoor Coil temperature sensor failure. (Indoor IPT failure)	Follow troubleshooting flow chart.
E3	Outdoor Coil temperature sensor failure. (OPT)	Follow troubleshooting flow chart.
E4	AC Cooling system abnormal	1. Check for leaking refrigerant or low refrigerant Refer to Sealed System Repair Section of this Manual.
E6	Indoor fan failure	Follow troubleshooting flow chart.
E7	Outdoor Ambient Temperature sensor failure	Follow troubleshooting flow chart.
E8	Outdoor Discharge Temperature sensor failure.	Follow troubleshooting flow chart.
E9	IPM / Compressor driving control abnormal.	Follow troubleshooting flow chart.
EA	Main PCB Current Test circuit failure	1. Replace Main PCB.
Eb	Communication abnormal of Main PCB and Display board	1. Replace Display or main PCBs .
EE	Main PCB EEPROM failure.	1. Replace Main PCB.
EF	Outdoor DC fan motor failure.	Follow troubleshooting flow chart.
EU	Main PCB Voltage test circuit abnormal.	Follow troubleshooting flow chart.
P0	IPM module protection.	Follow troubleshooting flow chart.
P1	Over / under voltage protection.	Follow troubleshooting flow chart.
P2	Over current protection.	Follow troubleshooting flow chart.
P4	Compressor Discharge pipe Over temperature protection.	Follow troubleshooting flow chart.
P5	Sub-cooling protection on Cooling mode.	Follow troubleshooting flow chart.
P6	Overheating protection on Cooling mode.	Follow troubleshooting flow chart.
P7	Overheating protection on Heating mode.	Follow troubleshooting flow chart.
P8	Outdoor Over temperature/Under temperature protection.	Follow troubleshooting flow chart.
P9	Compressor driving protection (Load abnormal).	Follow troubleshooting flow chart.
PA	Communication failure for TOP flow unit/ Preset mode conflict.	Replace Display PCB
F0	Infrared Customer feeling test sensor failure.	Check with remote Control function.
F1	Electric Power test module failure.	Check with remote Control function.
F2	Discharge temperature sensor failure PROTECTION."	Check Outdoor Exhaust Temp. sensor. Replace Manin PCB.

Figure 401

TROUBLESHOOTING

Fault Codes

Code	Reason	Remark
RT=Room Temperature NOTE: Always remove power from unit to reboot and see if fault clears before attempting to troubleshoot or repair.		
F3	Outdoor coil temperature failure PROTECTION..	1. Check Outdoor Pipe temp sensor. 2. Replace Main PCB.
F5	PFC PROTECTION	Follow troubleshooting flow chart.
F6	The Compressor lack of phase / Anti-phase PROTECTION.	Follow troubleshooting flow chart.
F7	IPM Module temperature PROTECTION	Follow troubleshooting flow chart.
F9	The module temperature test circuit failure.	Replace Main PCB.
FA	The compressor Phase-current test circuit failure.	Replace Main PCB.
Fb	Limiting/Reducing frequency for Over load protection on Cooling/Heating mode.	Check wih remote Control function.
FC	Limiting/Reducing frequency for High power consumption protection.	Check wih remote Control function.
FE	Limiting/Reducing frequency for Module current protection (phase current of compressor).	Check wih remote Control function.
FF	Limiting/Reducing frequency for Module temperature protection.	Check wih remote Control function.
FH	Limiting/Reducing frequency for Compressor driving protection.	Check wih remote Control function.
FP	Limiting/Reducing frequency for anti-condensation protection..	Check wih remote Control function.
FU	Limiting/Reducing frequency for anti-frost protection.	Check wih remote Control function.
Fj	Limiting/Reducing frequency for Discharge over temperature protection.	Check wih remote Control function.
Fn	Limiting/Reducing frequency for ODU AC Current protection."	Check wih remote Control function.
bf	TVOC sensor failure (IDU failure, optional)	Check wih remote Control function.
bc	PM2.5 sensor failure (IDU failure, optional)	Check wih remote Control function.
bj	Humidity sensor failure. (IDU failure)	Check wih remote Control function.
<p>Note: Remote control FAILURE CODE check function For codes (Fb–bj) the remote control is required to check the fault codes. While unit is runing, press the ECO button 8 times within 8 seconds. You will hear 2 audible beeps.</p>		

Figure 401

TROUBLESHOOTING

E0 Display PCB & Main PCB communication failure

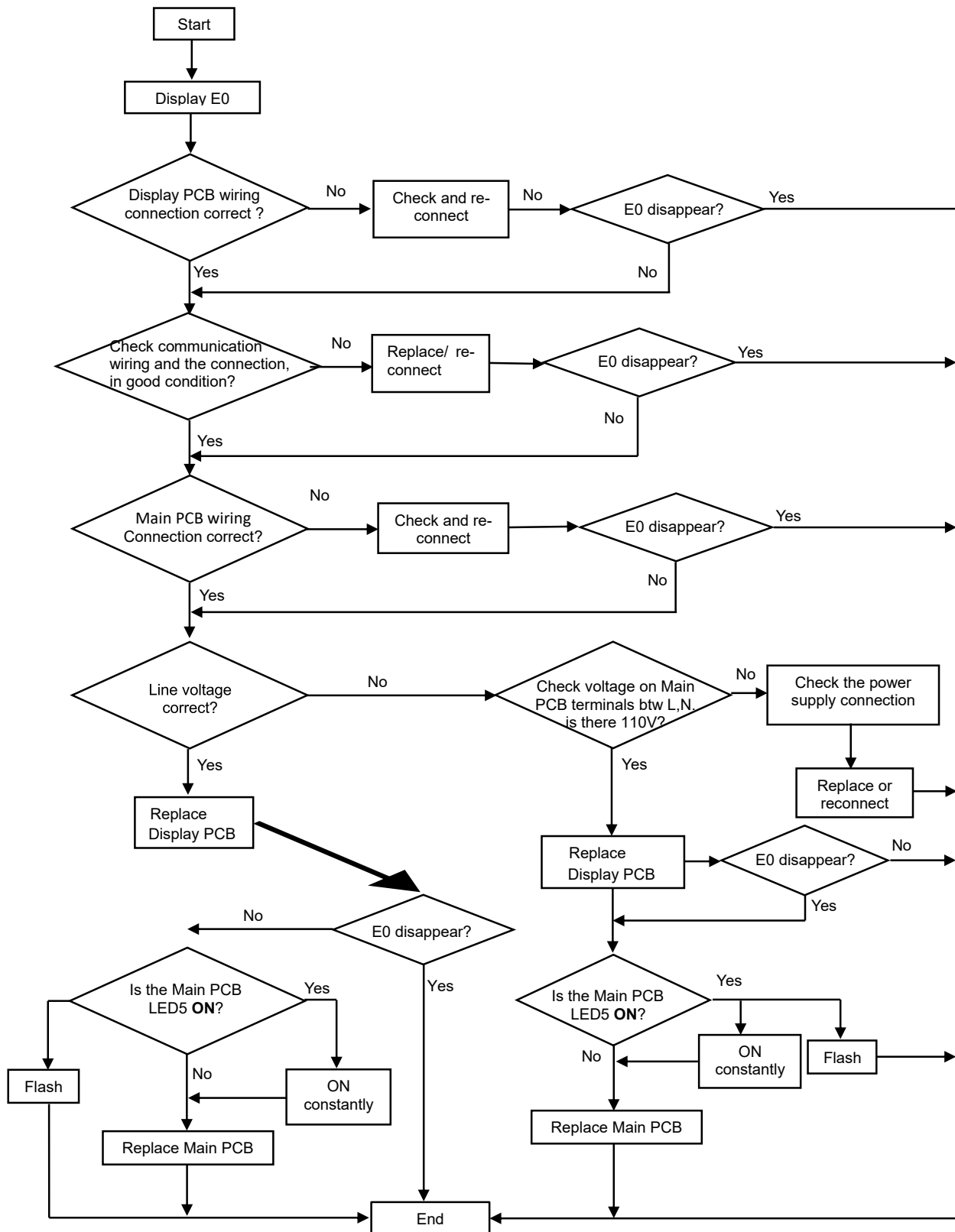

TROUBLESHOOTING

E1, E2 (Room temperature sensor and/or Indoor Coil Temperature Sensor Failure)

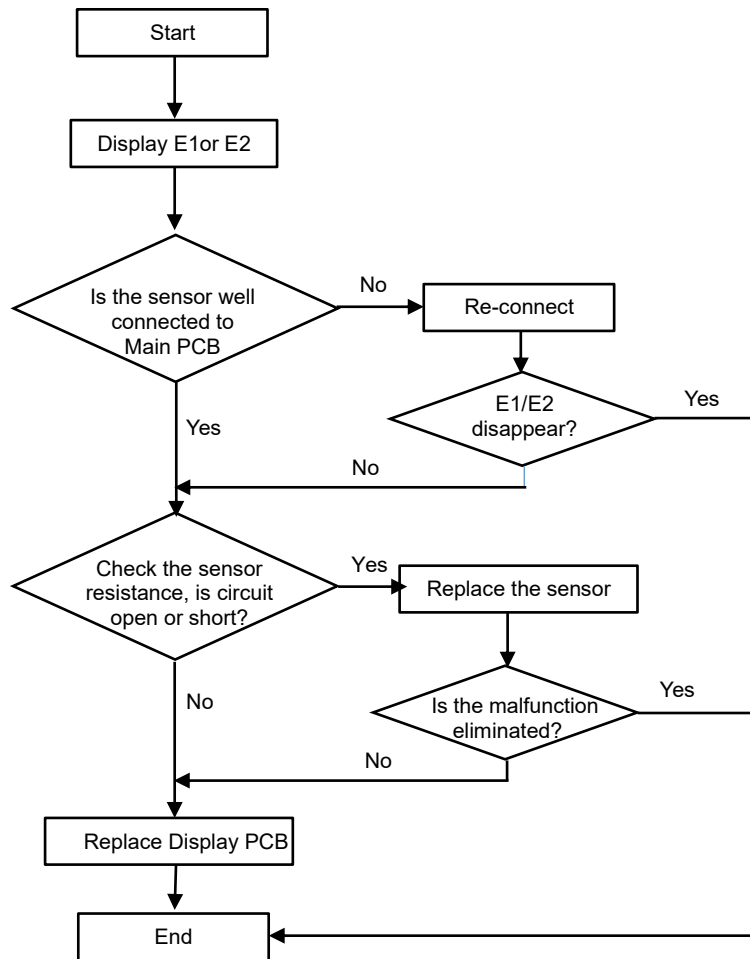

TROUBLESHOOTING

E6 Indoor ventilation failure

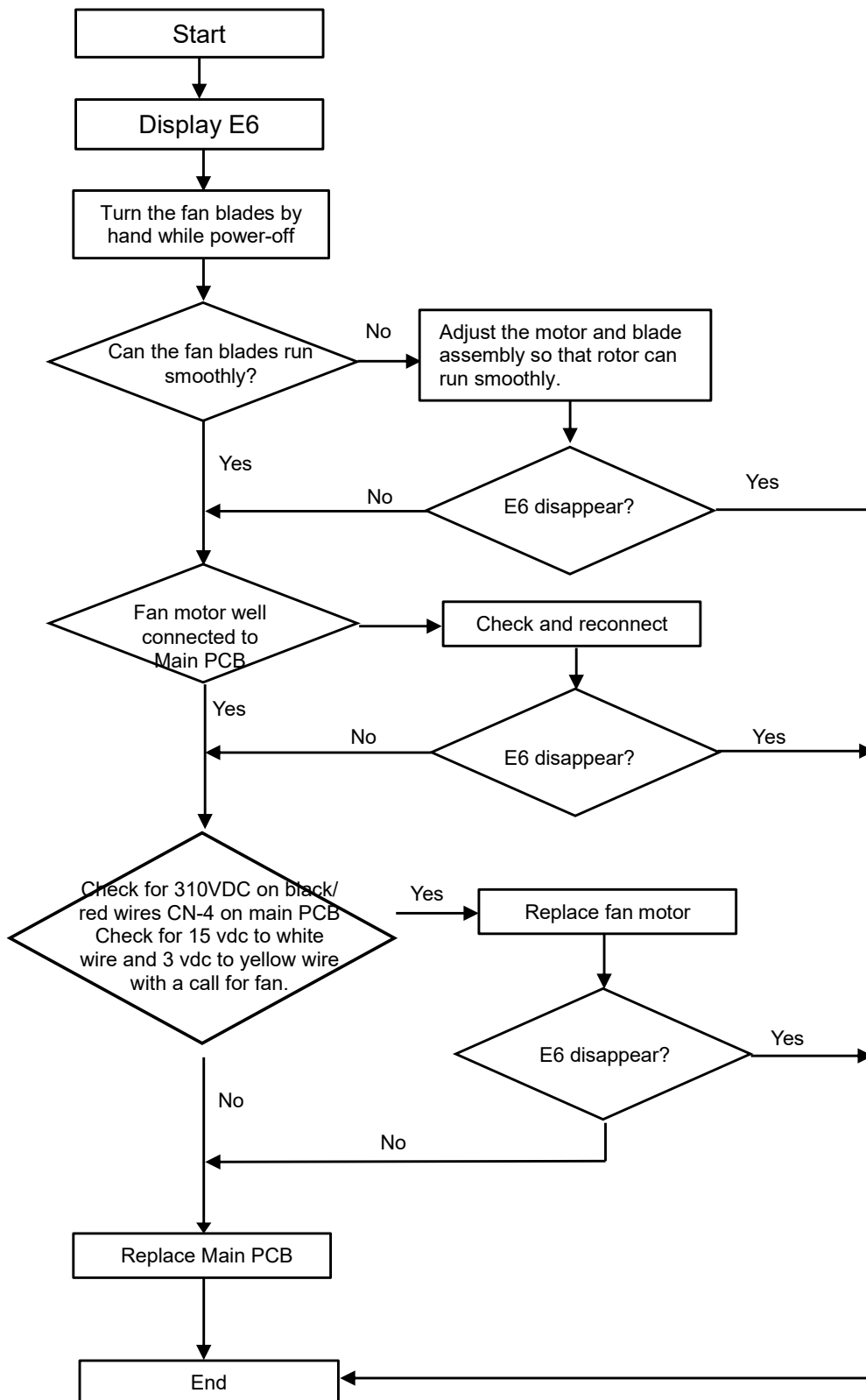

TROUBLESHOOTING

E3, E7 or E8 Outdoor Coil temperature sensor, Ambient temperature sensor or Discharge temperature sensor failure.

If any sensor resistance is open or shorted, unit will display failure code as E3/E7 or E8, Main PCB and Display PCB turn off. When the sensor resistance recovers, the unit reverts to standby, customer can switch on the unit directly.

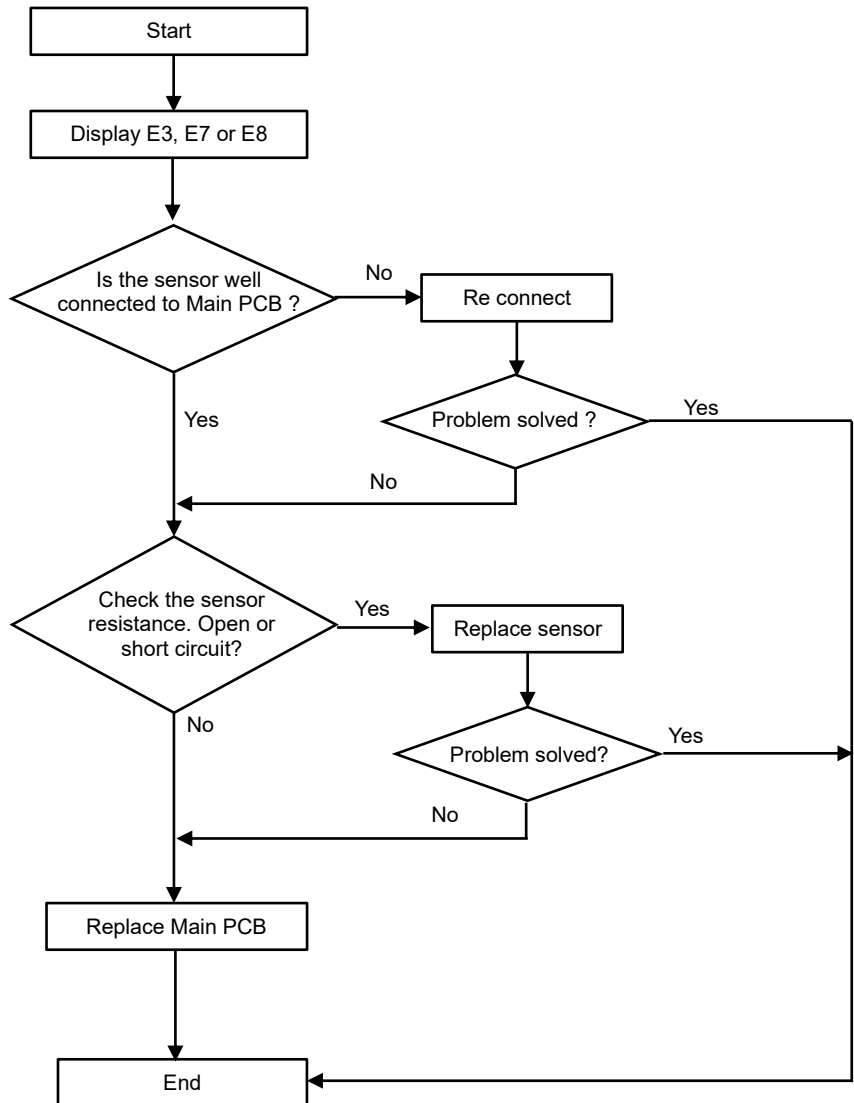

TROUBLESHOOTING

E9 IPM /Compressor Drive Fault

If unit has stopped working 6 times for IPM protection (P0) continuously, it will display E9 error. Unit will need to be restarted to resume operation.

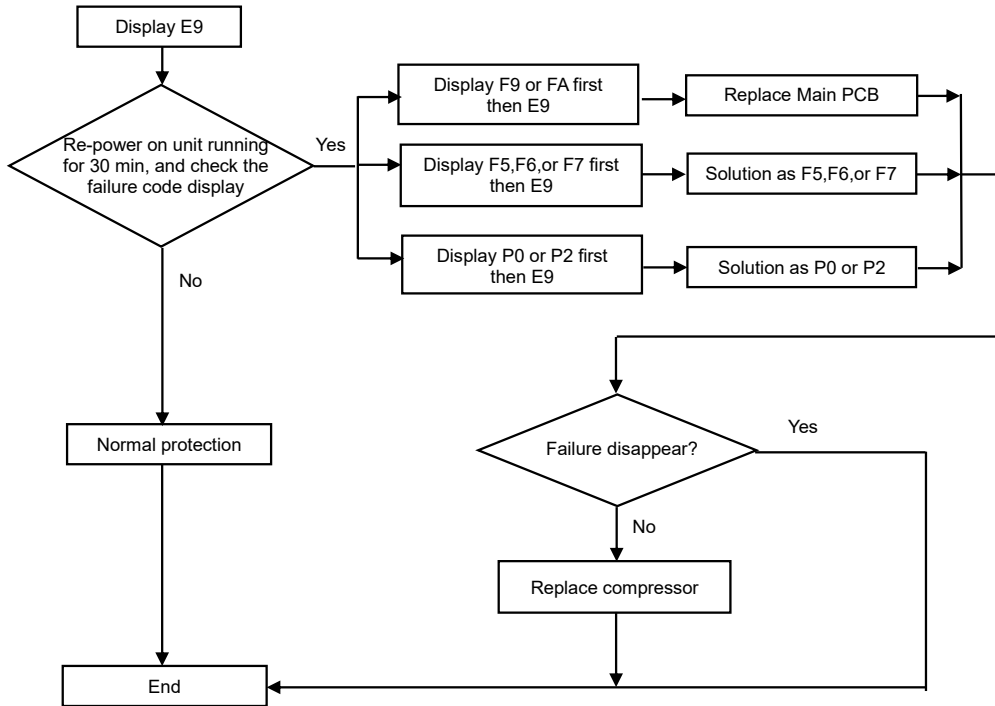

Remark:

1. F9 code

Reason: The IPM module temperature test circuit failure.

Solution: Replace the Main PCB.

2. FA code

Reason: The compressor phase-current test circuit failure.

Solution: Replace the Main PCB.

TROUBLESHOOTING

EF Outdoor DC fan motor failure

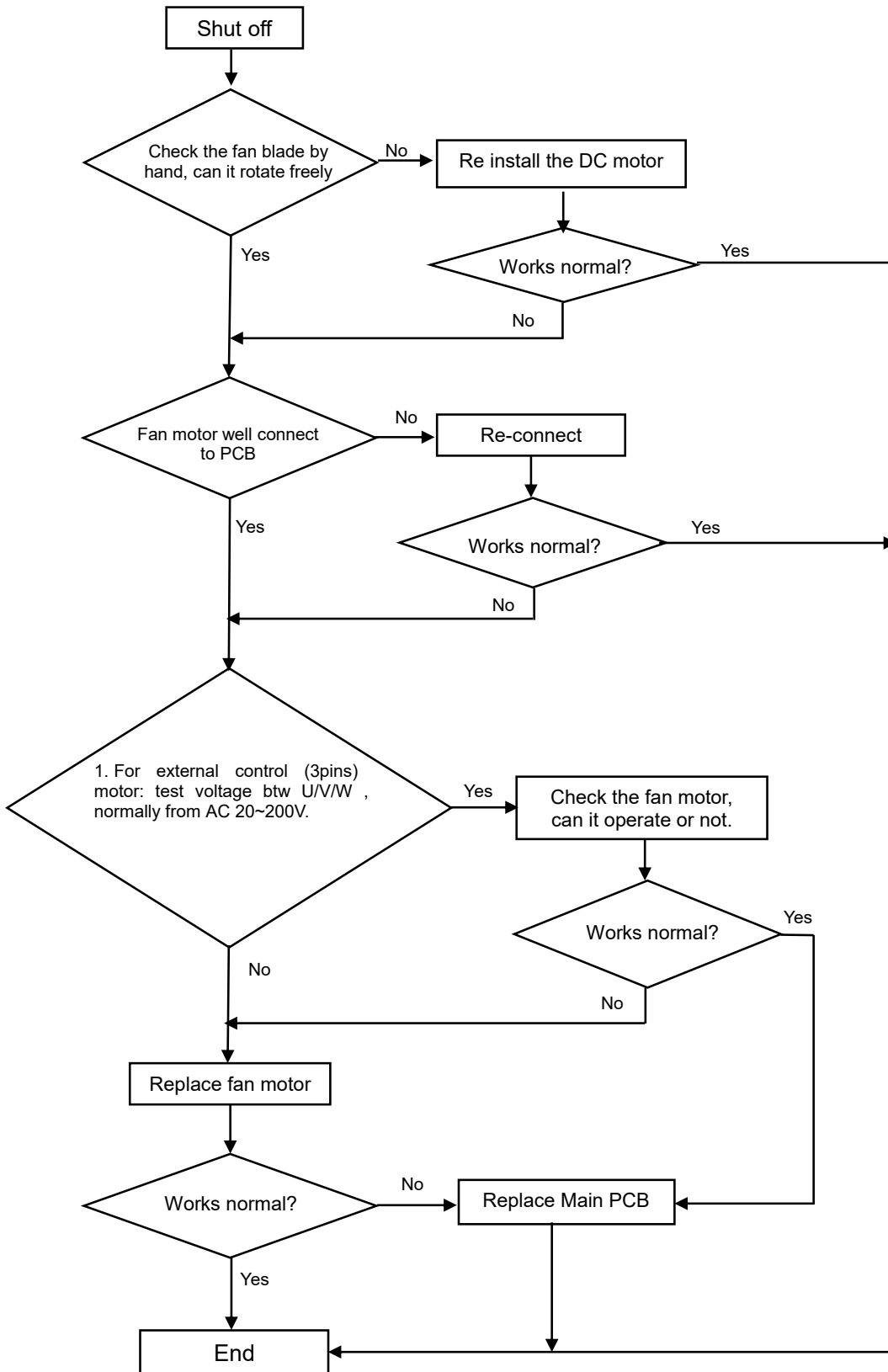

TROUBLESHOOTING

EU voltage test sensor failure

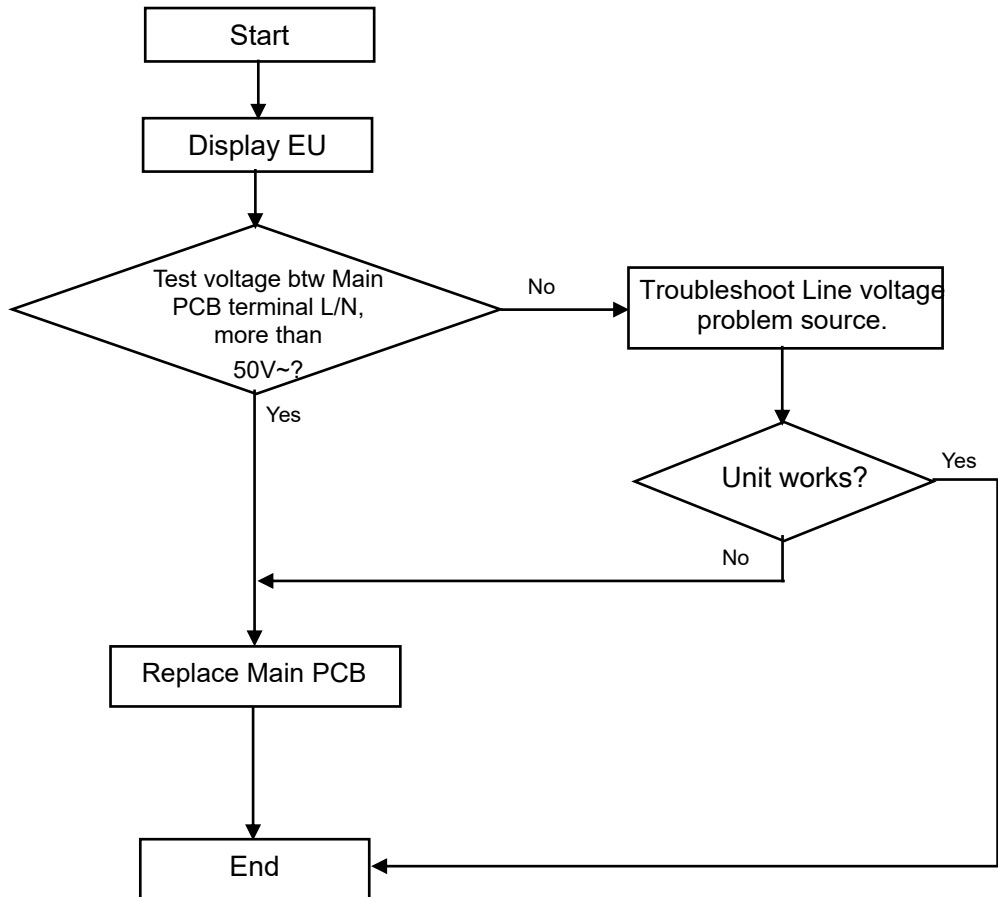

TROUBLESHOOTING

P0 IPM protection

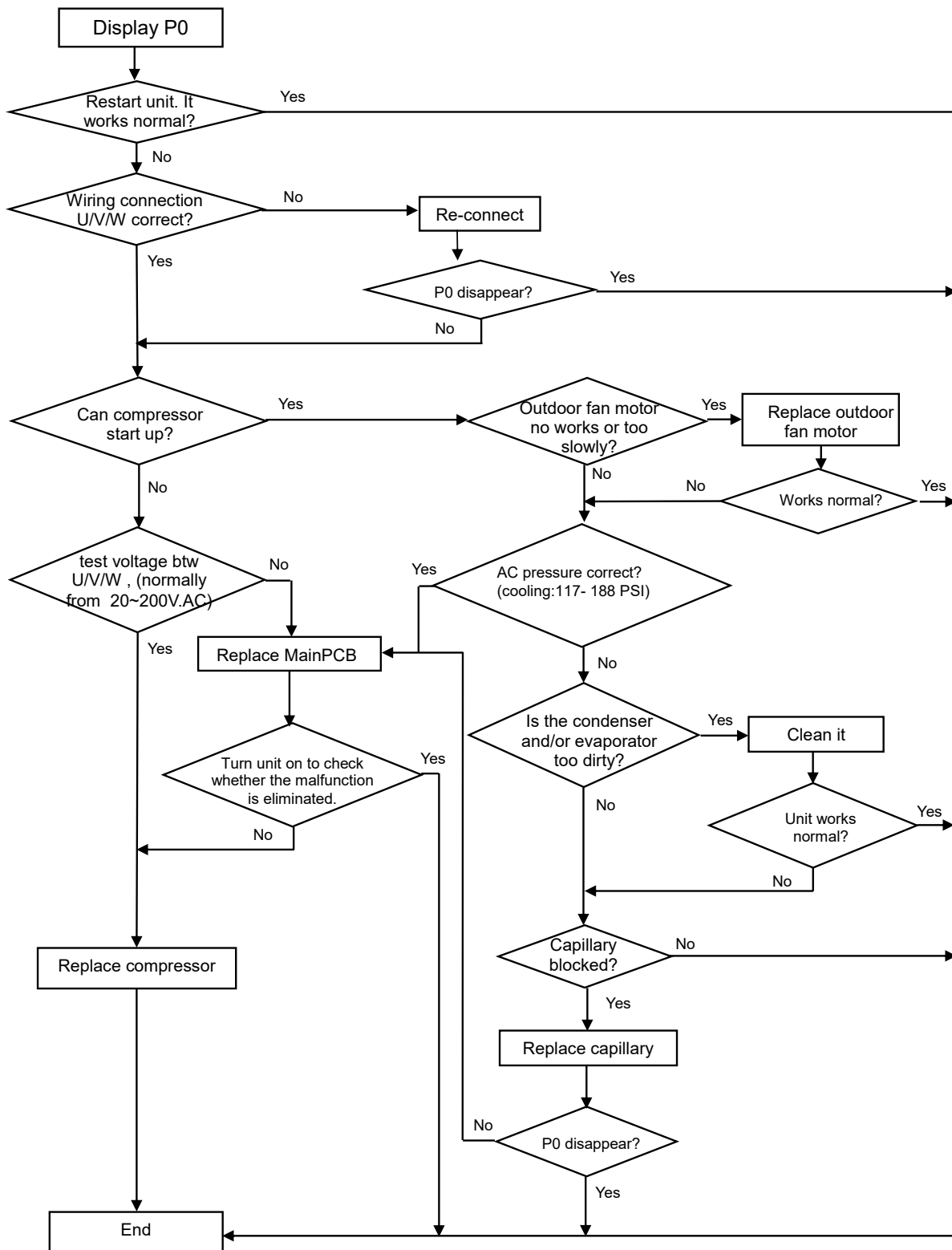

TROUBLESHOOTING

P1 Over / under voltage protection

1. Test voltage between L & N, When the power supply $V > AC 160V$ or $V < AC 85V$, AC will display P1 protection, unit will recover back to previous status while $V > AC 90V$.

2. Test voltage on the large electrolytic capacitor of Main PCB, When DC bus bar voltage $V > DC420V$ or $V < DC150V$, unit will recover back to previous status while $DC190V < V < DC410V$

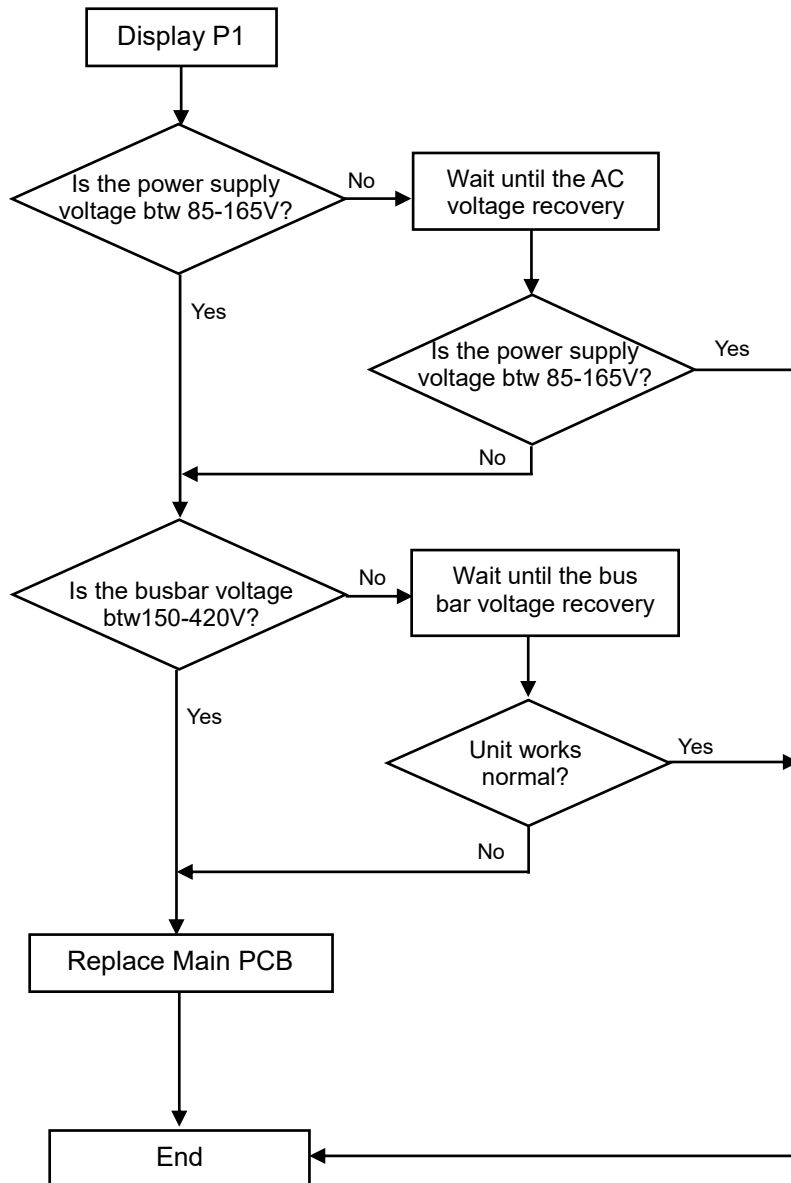

TROUBLESHOOTING

P2 Over Current protection

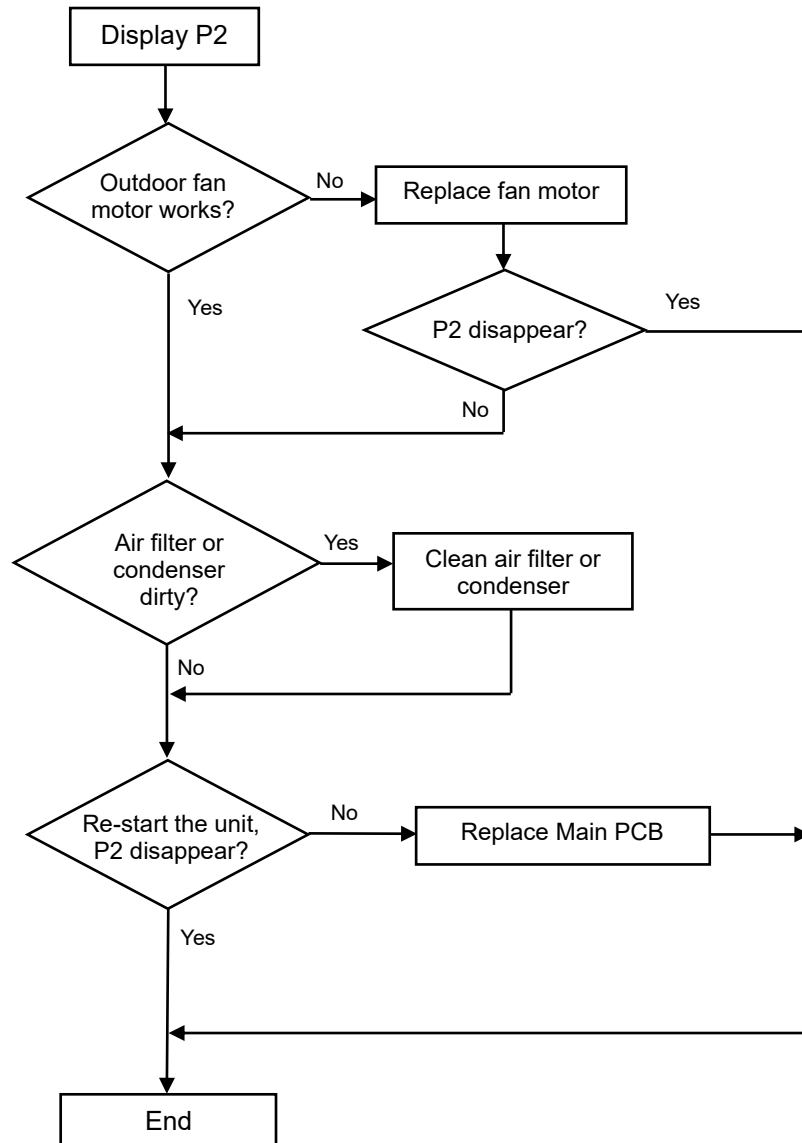

TROUBLESHOOTING

P4 Exhaust Air temperature overheating protection

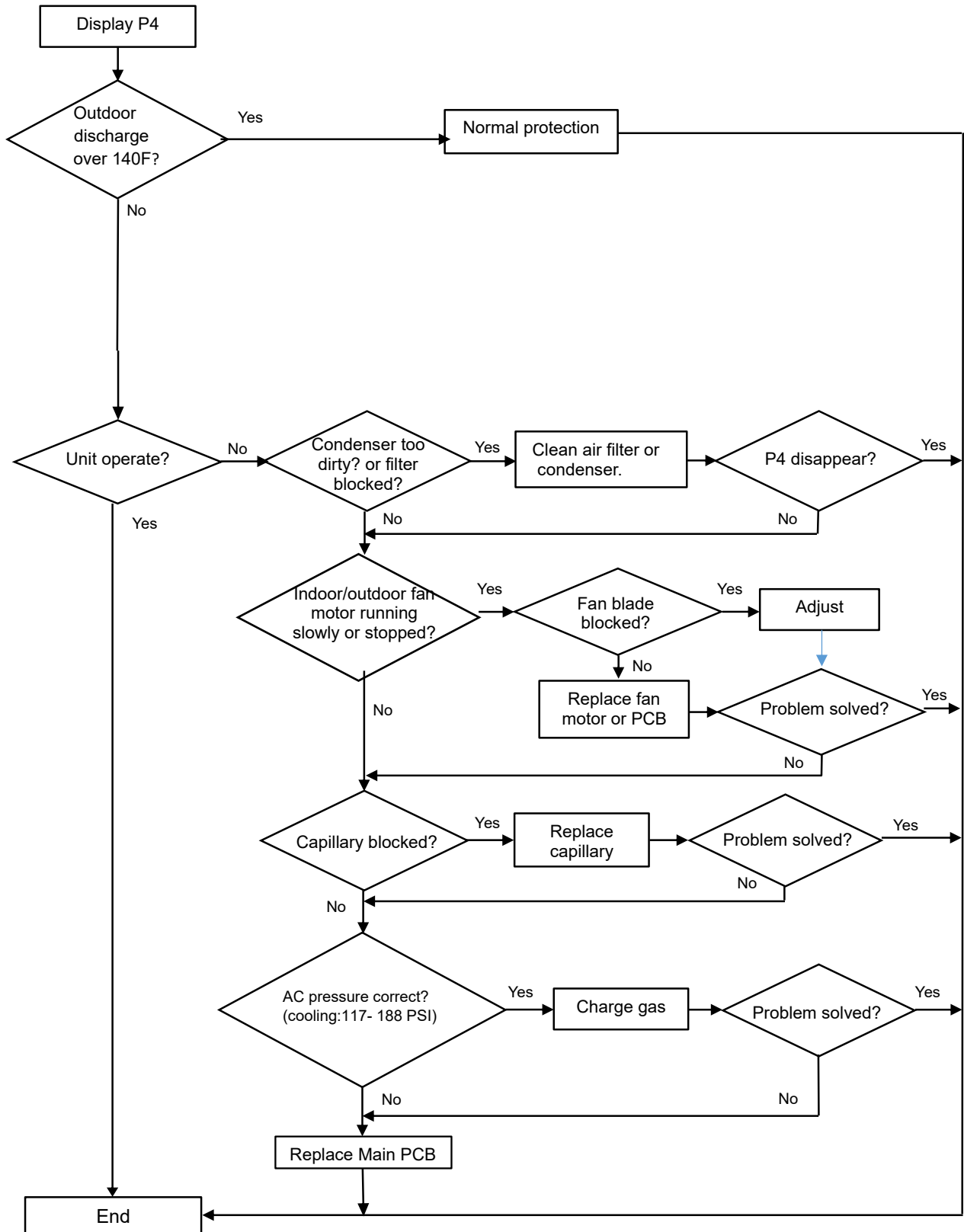

TROUBLESHOOTING

P5 Sub-cooling protection on Cooling/Dry mode

compressor start up for 6 min, CPU will switch off outdoor unit and show P5 failure code.

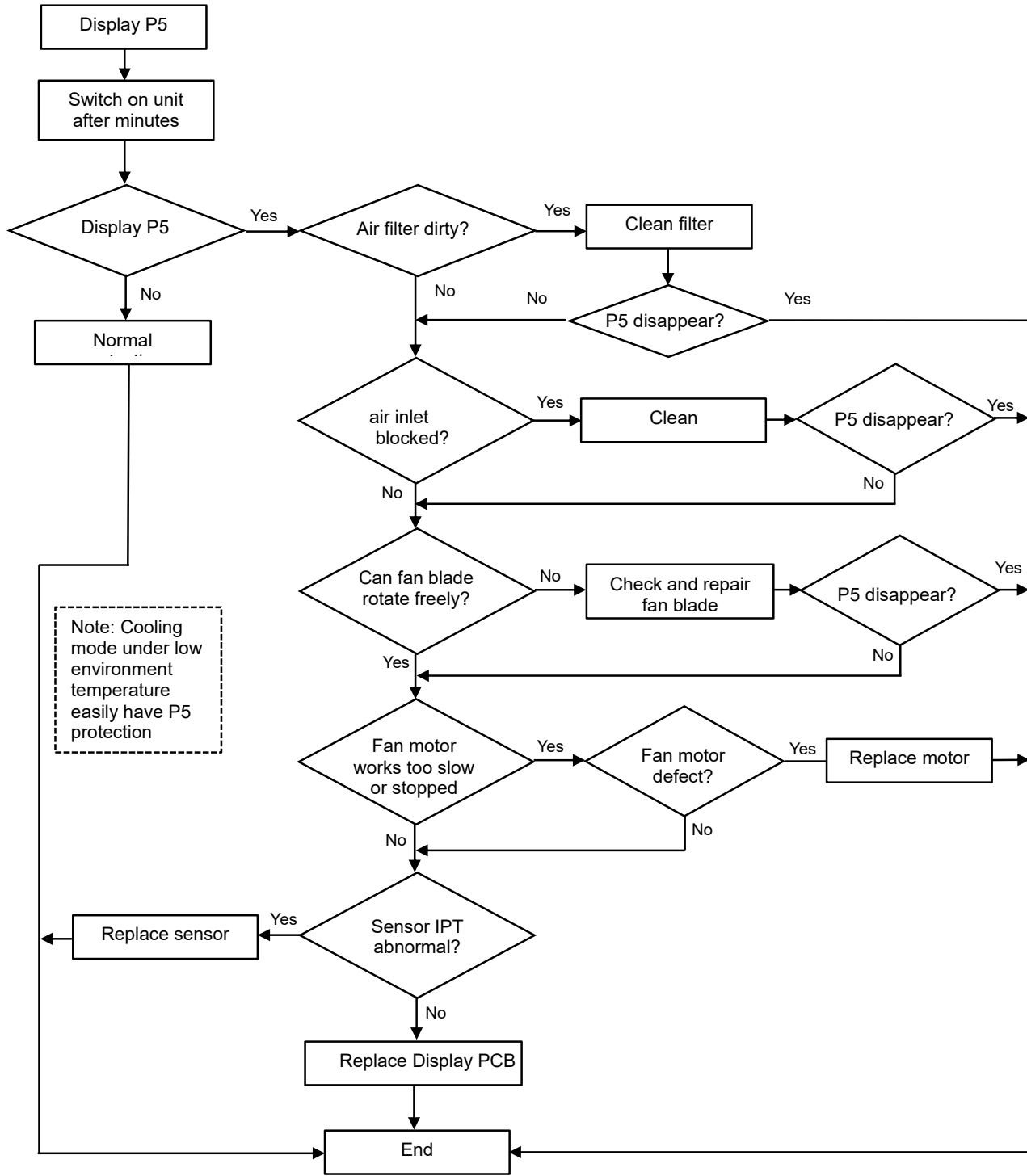

TROUBLESHOOTING

P6 Overheating protection on Cooling mode

- On Cooling or Dry mode, when ODU condenser coil temperature $OPT \geq 144^{\circ}\text{F}$, Main PCB will switch off outdoor unit and show P6 failure code.

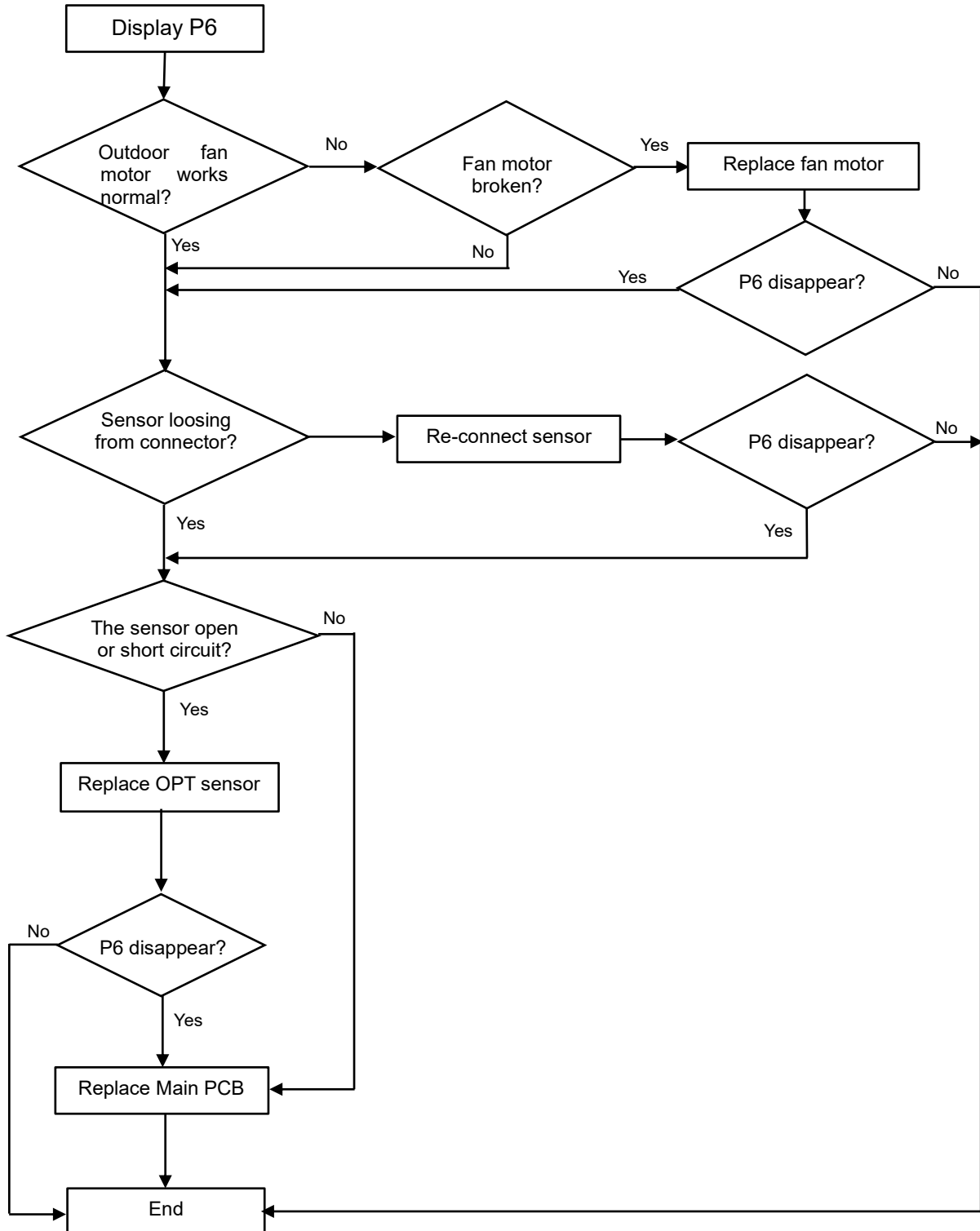

TROUBLESHOOTING

P7 Overheating protection on Cooling mode

On heating mode, when IDU evaporator coil temperature $IPT \geq 144^{\circ}\text{F}$, ODU PCB will switch off outdoor unit and show P7 failure code.

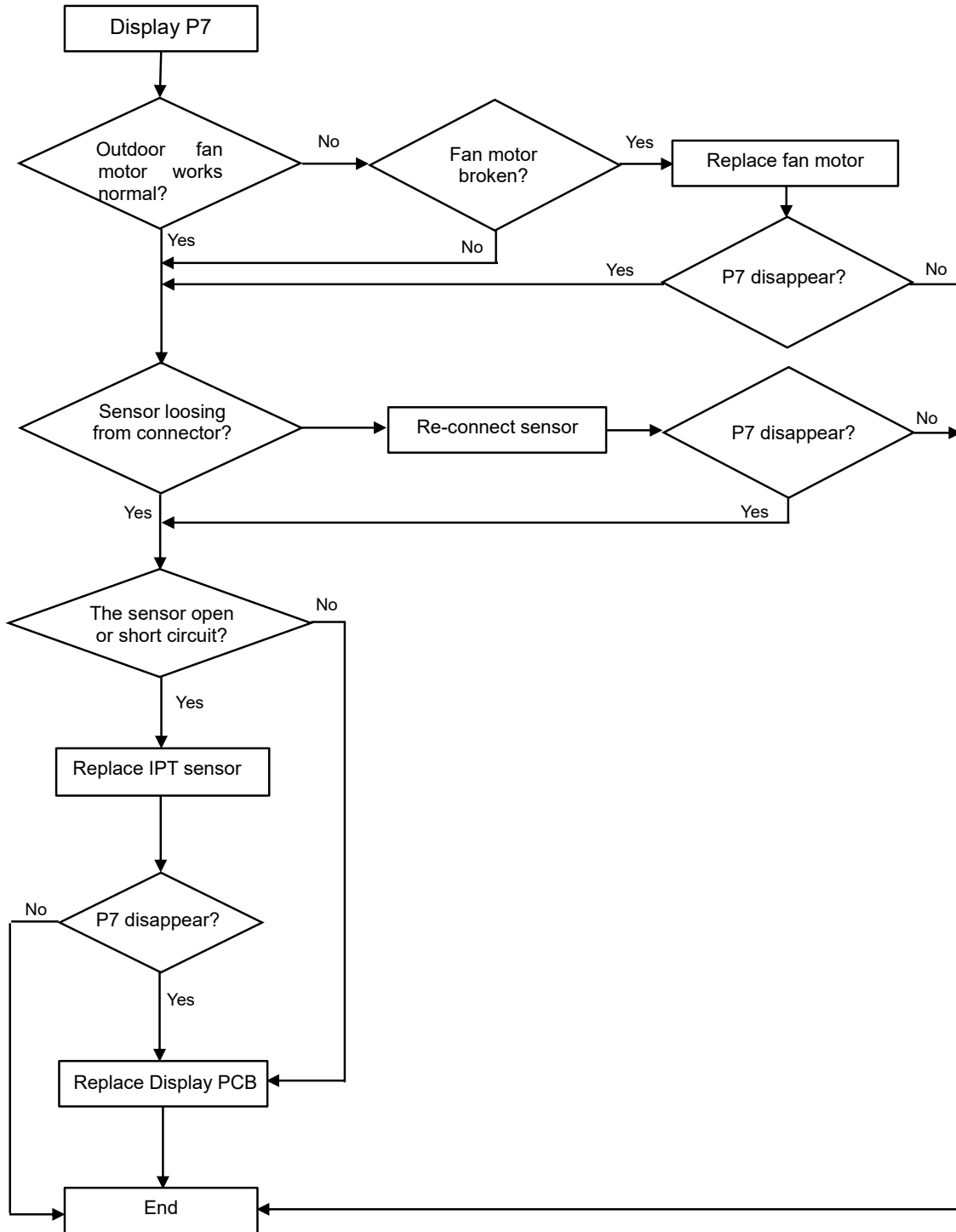

TROUBLESHOOTING

P8 Exhaust Air Overtemperature/Under temperature protection

A P8 fault will occur if the following conditions occur and force the compressor to shut down for more than 200 seconds.

(1). **On Cooling or Dry mode:** Outdoor ambient temperature: $OAT < -4^{\circ}F$ or $OAT > 145^{\circ}F$

(2). **On Heating mode:**

a. $OAT \geq 104^{\circ}F$ or

b. $86^{\circ}F < OAT \leq 104^{\circ}F$ and $RT > 95^{\circ}F$

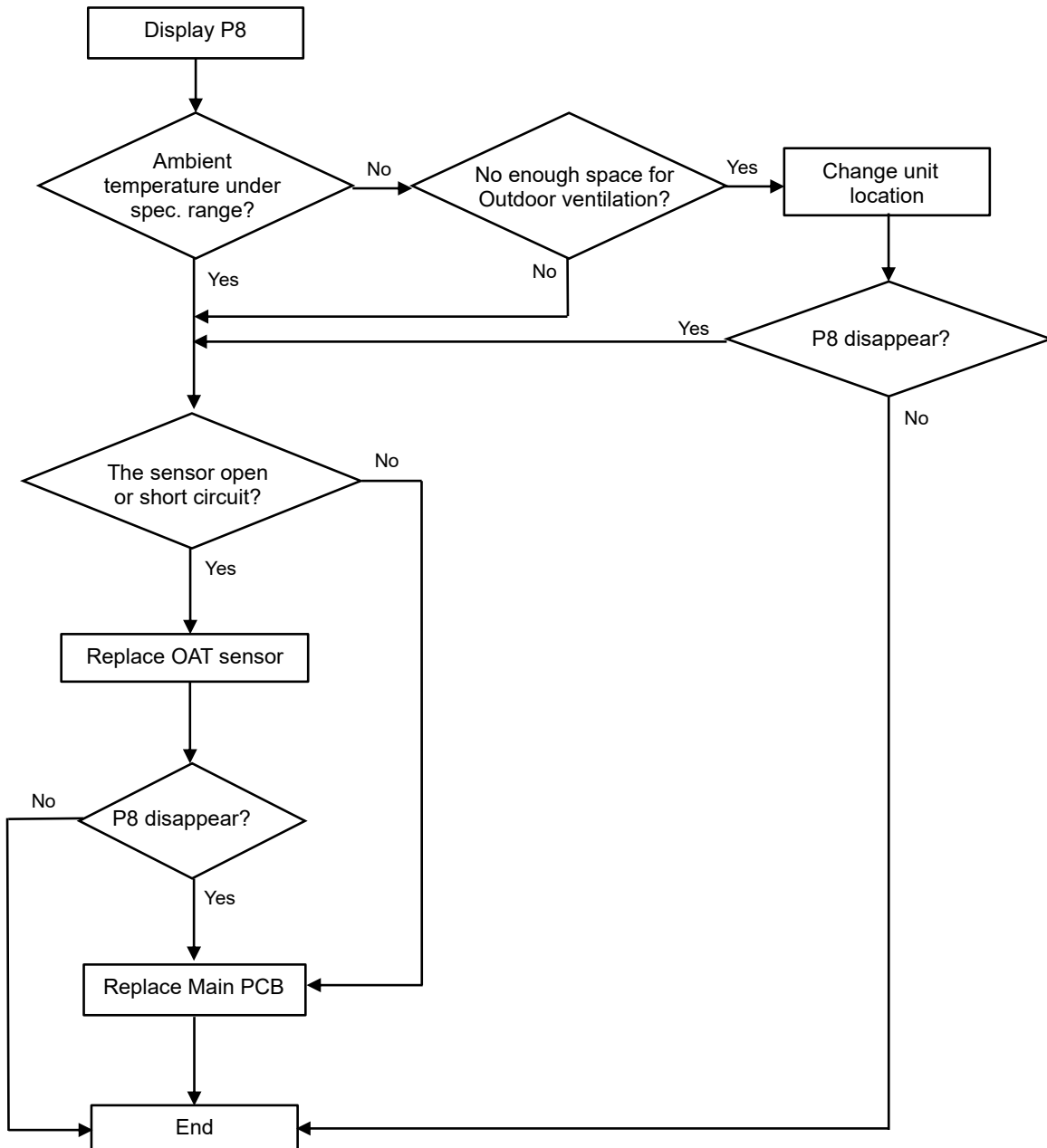

TROUBLESHOOTING

P9 The compressor driving protection (the compressor load abnormal)

When compressor starts up or in the process of operation, if:

- (1). MCU can't test the feedback signal from compressor, or
- (2). Tested a abnormal signal from compressor, or
- (3). The compressor startup abnormal.

The outdoor unit will shut off, and show P9 protection.

(The unit will re-startup 6 times continuously, if it still can't work normal, then show P9 code)

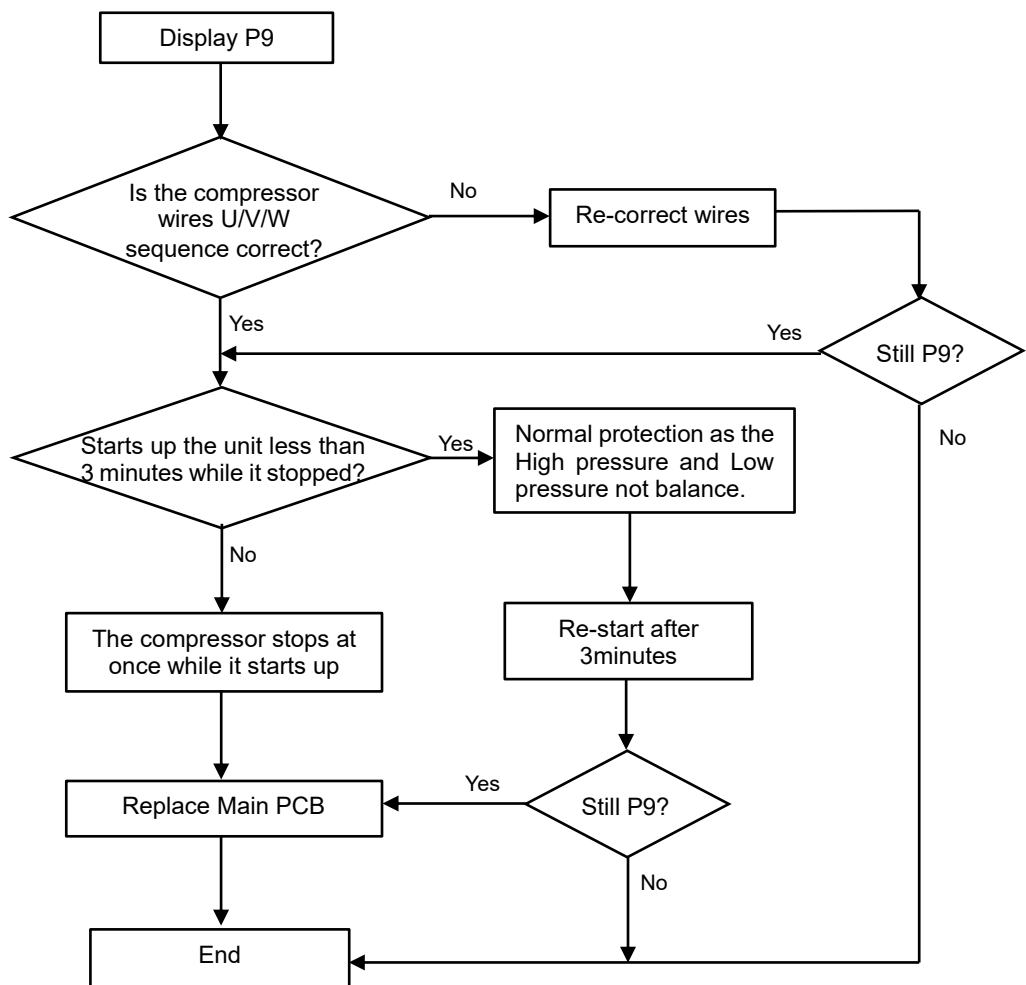

TROUBLESHOOTING

F5 PFC Protection

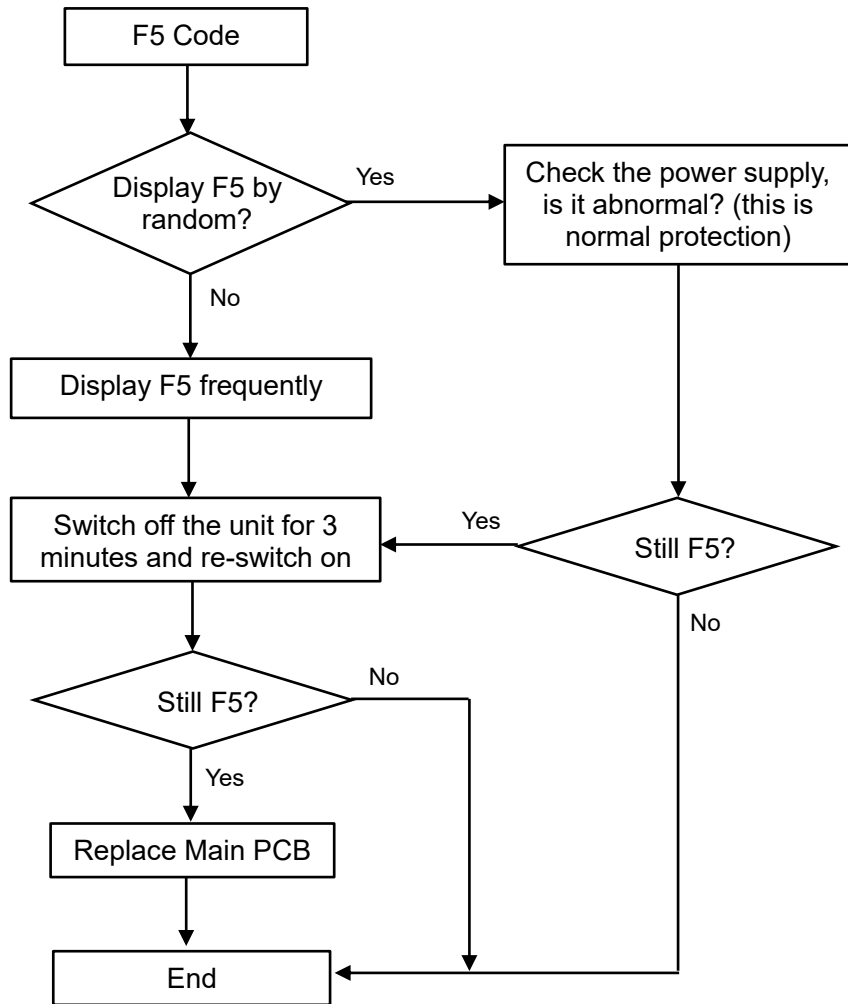

TROUBLESHOOTING

F6 The Compressor Lack of phase / Anti phase protection.

If Main PCB detects a missing phase, or out of phase it will show F6 protection.

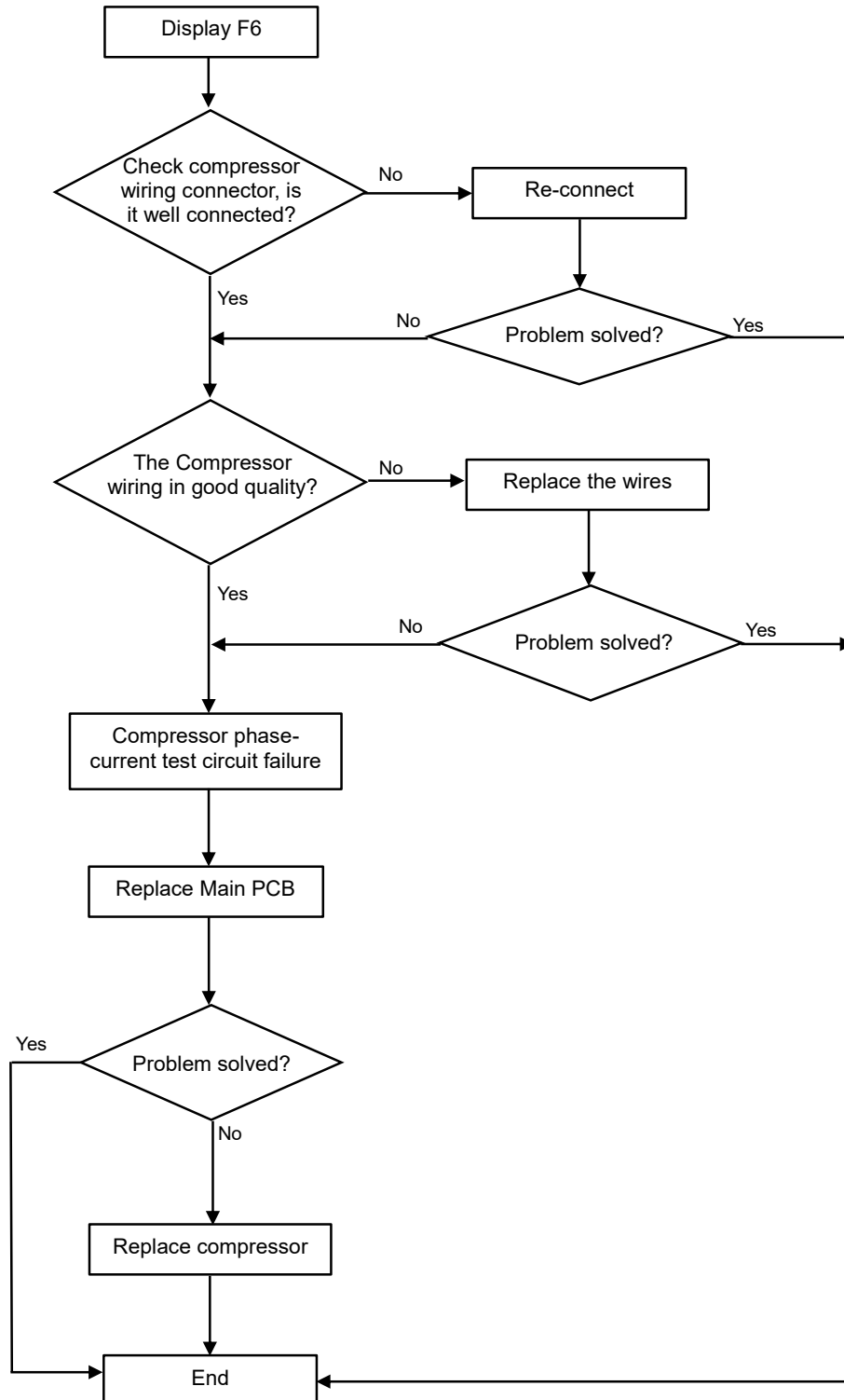

TROUBLESHOOTING

F7 IPM Module temperature protection.

IPM overtemperature protection, when IPM temperature more than 203 degrees F, it will show F7.

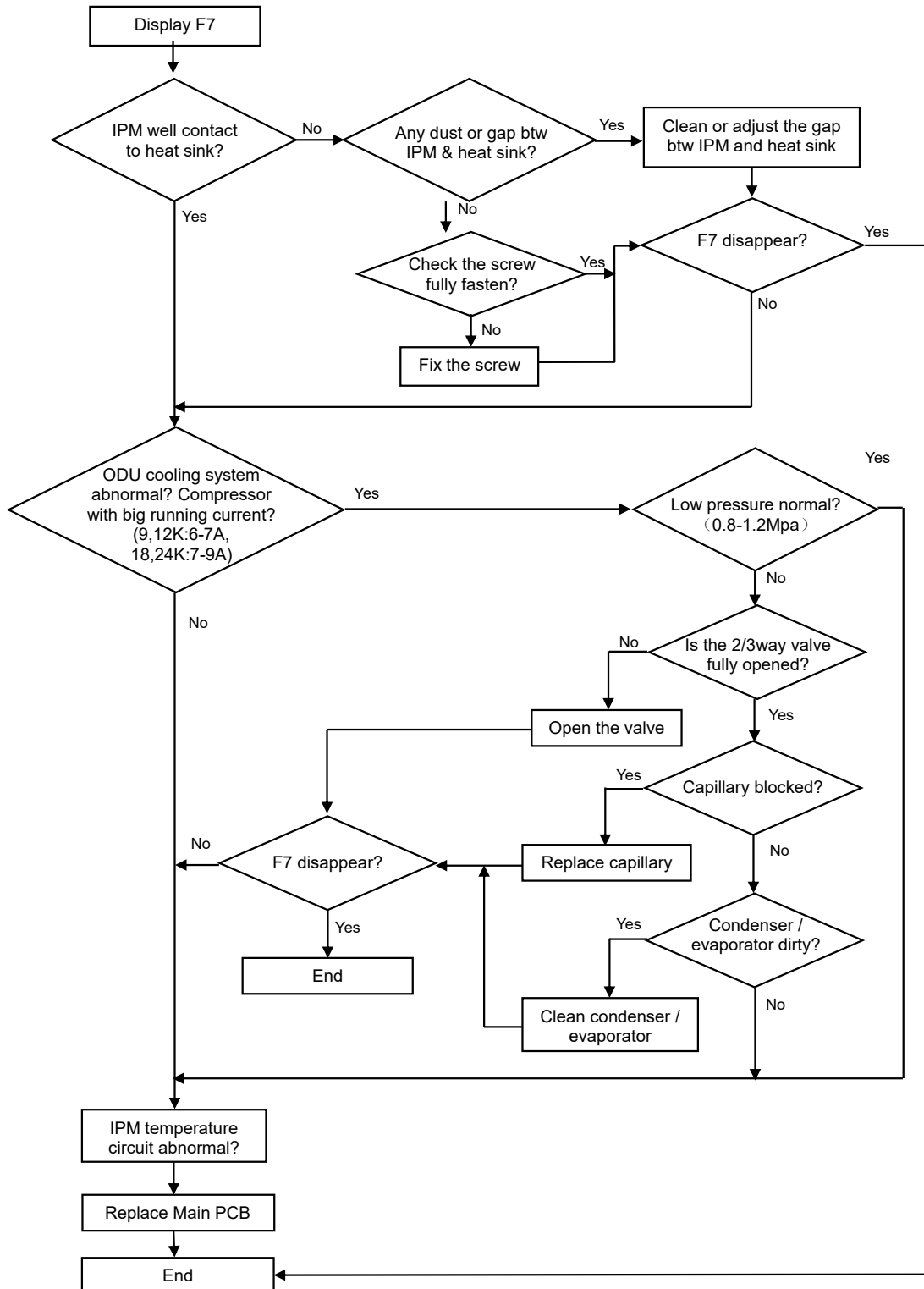

TROUBLESHOOTING

Check Thermistors

1. Gain Acces to Main PCB board
2. Using a multi meter ohm across applicaple pins for the sensor you are checking.
3. Refer to thermistor chart on following for resistance and temperature deviation.
4. Replace sensor if open or if resistance values deviate by more than 10% of the listed values.

MODEL	Indoor Evironment Temp Sensor	Indoor Pipe Temp Sensor	Outdoor Environment Temp Sensor	Outdoor Pipe Temp Sensor	Outdoor Exhaust Temp Sensor
CCV08A10A	5 k Ω)	5 k Ω)	5 k Ω)	5 k Ω)	20 k Ω)
CCV10A10A	5 k Ω)	5 k Ω)	5 k Ω)	5 k Ω)	20 k Ω)
CCV12A10A	5 k Ω)	5 k Ω)	5 k Ω)	5 k Ω)	20 k Ω)

TROUBLESHOOTING

ROOM AIR CONDITIONER UNIT PERFORMANCE TEST DATA SHEET			
JOB NAME _____	TECH'S NAME _____		
DATE _____	MODEL# _____	SERIAL # _____	
CHECK THE INSTALLATION	ACCEPTABLE	NOT ACCEPTABLE	
		YES	NO
IS A CHASIS GASKET INSTALLED?		_____	_____
IS THE FRESH / EXHAUST AIR VENT OPEN?		_____	_____
IS A FRIEDRICH SLEEVE INSTALLED?	_____	_____	_____
IS A FRIEDRICH OUTDOOR GRILLE INSTALLED?	_____	_____	_____
IS MAINTENANCE BEING PERFORMED?		_____	_____
ELECTRICAL			
LINE VOLTAGE (STATIC)		_____ VOLTS	
START UP VOLTAGE		_____	VOLTS
AMPERAGE DRAW (COOL)		_____	AMPS
AMPERAGE DRAW (HEAT)		_____	AMPS
COMPRESSOR			
RUNNING AMPERAGE DRAW		_____	AMPS
INDOOR CONDITIONS			
INDOOR AMBIENT TEMPERATURE		_____ F	
RELATIVE HUMIDITY (RH) INDOOR		_____	%
DISCHARGE AIR TEMPERATURE (INDOOR)(COOL)		_____	F
DISCHARGE AIR TEMPERATURE (INDOOR)(HEAT)		_____	F
RETURN AIR TEMPERATURE (INDOOR)(COOL)		_____	F
RETURN AIR TEMPERATURE (INDOOR) (HEAT)		_____	F
OUTDOOR TEMPERATURE			
OUTDOOR AMBIENT TEMPERATURE		_____ F	
RH OUTDOOR RELATIVE HUMIDITY		_____	%
DISCHARGE AIR TEMPERATURE (OUTDOOR)(COOL)	_____	F	
DISCHARGE AIR TEMPERATURE (OUTDOOR)(HEAT)	_____	F	
INTAKE AIR TEMPERATURE (OUTDOOR)(COOL)		_____ F	
INTAKE AIR TEMPERATURE (OUTDOOR)(HEAT)		_____ F	
COOLING OR HEATING AREA			
AREA W _____	* L _____	= FEET SQUARED	
FOR A GENERAL GUIDE REFER TO SIZING GUIDE TO THE RIGHT			
FOR EXACT LOAD CALCULATIONS CONSULT MANUAL J OR M.			

Figure 402 (Test Data Sheet)

COOLING SIZING GUIDE

AREA TO BE CONDITIONED IN SQ. FT.	APPROXIMATE COOLING BTU REQUIRED
100 - 150	5000
150 - 250	6000
250 - 300	7000
300 - 350	8000
350 - 400	9000
400 - 450	10000
450 - 550	12000
550 - 700	14000
700 - 1000	18000
1000 - 1200	21000
1200 - 1400	23000
1400 - 1500	24000
1500 - 2000	30000
2000 - 2500	34000

Guide based on normal room insulation, average number of sun exposed windows and two person occupancy.

1. If heavily shaded, reduce cooling Btus required by 10%
2. If very sunny, increase cooling Btus required by 10%
3. Add 500 Btus per person over 2 people
4. Add 4,000 Btus if the area is a kitchen

Figure 403 (Cooling Sizing Guide)

TROUBLESHOOTING

Undercharged Refrigerant Systems

⚠ WARNING	
	<p>RISK OF ELECTRIC SHOCK</p> <p>Unplug and/or disconnect all electrical power to the unit before performing inspections, maintenances or service.</p>
	<p>Failure to do so could result in electric shock, serious injury or death.</p>

NOTE: Ensure fan is on high speed during testing.

An undercharged system will result in poor performance (low pressures, etc.) in both the heating and cooling cycle.

Whenever you service a unit with an undercharge of refrigerant, always suspect a leak. The leak must be repaired before charging the unit.

To check for an undercharged system, turn the unit on, allow the compressor to run long enough to establish working pressures in the system (15 to 20 minutes).

During the cooling cycle you can listen carefully at the exit of the metering device into the evaporator; an intermittent hissing and gurgling sound indicates a low refrigerant charge. Intermittent frosting and thawing of the evaporator is another indication of a low charge, however, frosting and thawing can also be caused by insufficient air over the evaporator.

Checks for an undercharged system can be made at the compressor. If the compressor seems quieter than normal, it is an indication of a low refrigerant charge.

If the compressor reads low amperage and has a high discharge line temperature at the compressor, it is an indication of low system refrigerant.

A check of the amperage drawn by the compressor motor should show a lower reading. (Check the Unit Specification.) After the unit has run 10 to 15 minutes, check the gauge pressures. Gauges connected to system with an undercharge will have low head pressures and substantially low suction pressures.

⚠ WARNING	
	<p>HIGH PRESSURE HAZARD</p> <p>Sealed Refrigeration System contains refrigerant and oil under high pressure.</p>
	<p>Proper safety procedures must be followed, and proper protective clothing must be worn when working with refrigerants.</p>
	<p>Failure to follow these procedures could result in serious injury or death.</p>

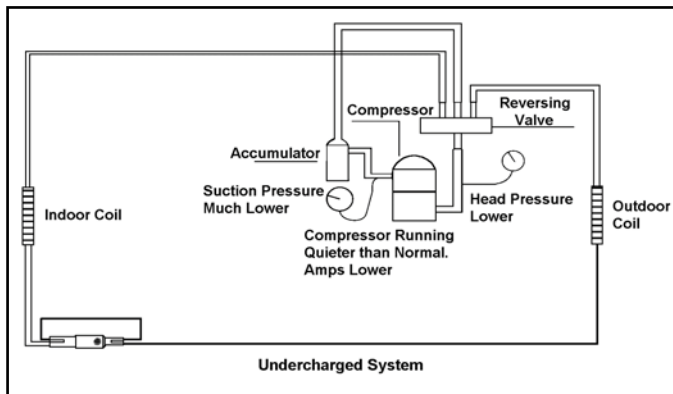



Figure 404 (Undercharged System)

TROUBLESHOOTING

Overcharged Refrigerant Systems

⚠ WARNING	
	<p>RISK OF ELECTRIC SHOCK</p> <p>Unplug and/or disconnect all electrical power to the unit before performing inspections, maintenances or service.</p>
	<p>Failure to do so could result in electric shock, serious injury or death.</p>

NOTE: Ensure fan is on high speed during testing. Compressor amps will be near normal or higher. Noncondensables can also cause these symptoms. To confirm, remove some of the charge, if conditions improve, system may be overcharged. If conditions don't improve, Noncondensables are indicated.

NOTE: Factory sealed units will not be overcharged

Whenever an overcharged system is indicated, always make sure that the problem is not caused by air flow problems. Improper air flow over the evaporator coil may indicate some of the same symptoms as an over charged system.

An overcharge can cause the compressor to fail, since it would be "slugged" with liquid refrigerant.

The charge for any system is critical. When the compressor is noisy, suspect an overcharge, when you are sure that the air quantity over the evaporator coil is correct. Icing of the evaporator will not be encountered because the refrigerant will boil later if at all. Gauges connected to system will usually have higher head pressure (depending upon amount of over charge). Suction pressure should be slightly higher.

⚠ WARNING	
	<p>HIGH PRESSURE HAZARD</p> <p>Sealed Refrigeration System contains refrigerant and oil under high pressure.</p>
	<p>Proper safety procedures must be followed, and proper protective clothing must be worn when working with refrigerants.</p>
	<p>Failure to follow these procedures could result in serious injury or death.</p>

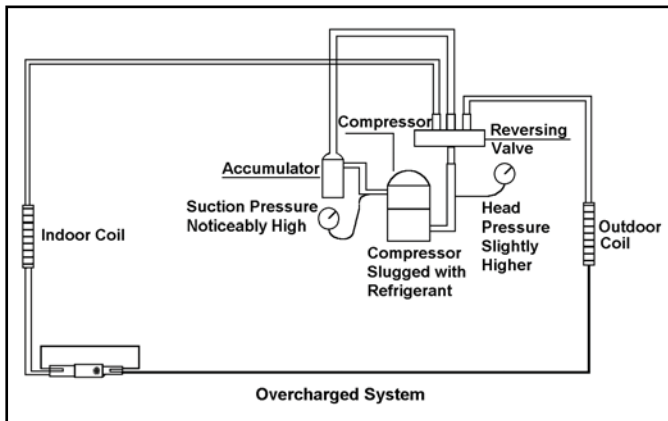

Figure 405 (Overcharged System)

TROUBLESHOOTING

Restricted Refrigerant System

NOTE: Ensure fan is on high speed during testing.

Troubleshooting a restricted refrigerant system can be difficult. The following procedures are the more common problems and solutions to these problems. There are two types of refrigerant restrictions: Partial restrictions and complete restrictions.

A partial restriction allows some of the refrigerant to circulate through the system.

With a complete restriction there is no circulation of refrigerant in the system. Restricted refrigerant systems display the same symptoms as a "low-charge condition."

A quick check for either condition begins at the evaporator. With a partial restriction, there may be gurgling sounds at the metering device entrance to the evaporator. The evaporator in a partial restriction could be partially frosted or have an ice ball close to the entrance of the metering device. Frost may continue on the suction line back to the compressor.

Often a partial restriction of any type can be found by feel, as there is a temperature difference from one side of the restriction to the other. There will usually be a difference felt at the capillary tube. This does not indicate a restricted condition.

With a complete restriction, there will be no sound at the metering device entrance. An amperage check of the compressor with a partial restriction may show normal current when compared to the unit specification. With a complete restriction the current drawn may be considerably less than normal, as the compressor is running in a deep vacuum (no load.) Much of the area of the condenser will be relatively cool since most or all of the liquid refrigerant will be stored there.

Make all checks possible before tapping into the system and installing gauges.

When the unit is shut off, or the compressor disengages, the gauges may equalize very slowly.

The following conditions are based primarily on a system in the cooling mode.

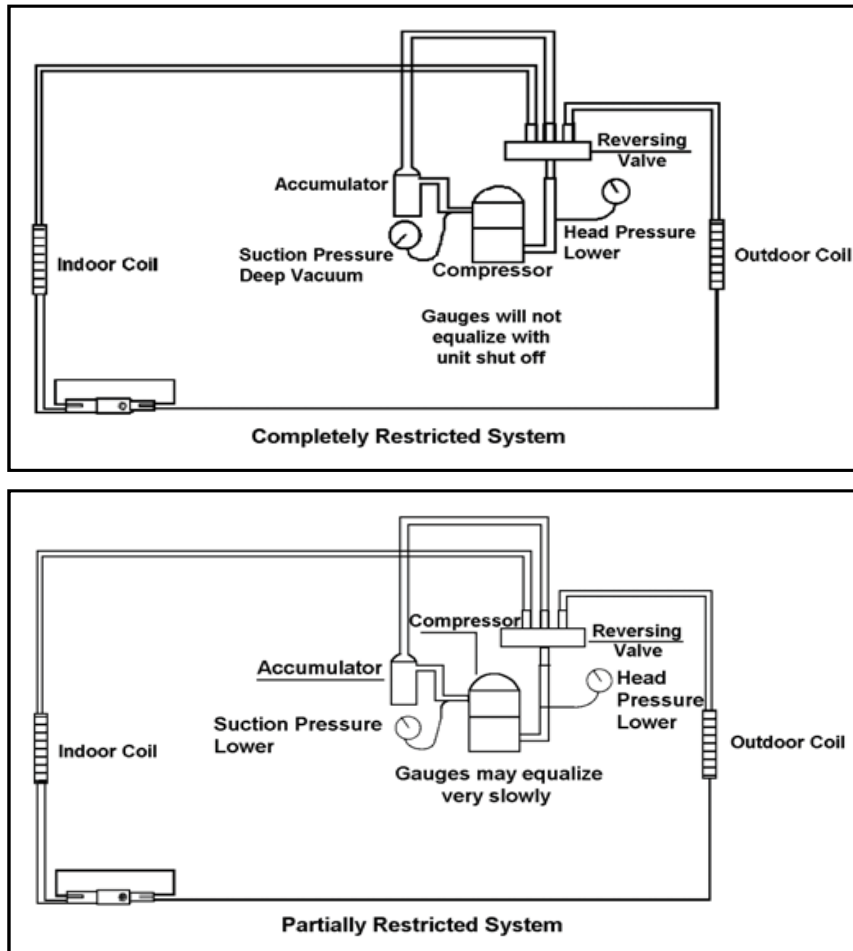



Figure 406(Restricted System)

COMPONENT TESTING

Check Capillary Tube

⚠ WARNING	
	<p>BURN HAZARD</p> <p>Proper safety procedures must be followed, and proper protective clothing must be worn when working with a torch.</p> <p>Failure to follow these procedures could result in moderate or serious injury.</p>

⚠ WARNING	
	<p>CUT/SEVER HAZARD</p> <p>Be careful with the sharp edges and corners. Wear protective clothing and gloves, etc.</p> <p>Failure to do so could result in serious injury.</p>

Test the Capillary Tube and Check Valve Assy

1. Check the capillary tube temperature by hand where the refrigerant enters the capillary tube. A partial restriction of the capillary tube will be indicated by frost or freezing in that area.
2. If the capillary tube is fully restricted, then pressure will increase and pressure switch will open if installed. If no pressure switch is installed, the unit will shut down due to the compressor overload opening. High discharge temperature will be present at the compressor.

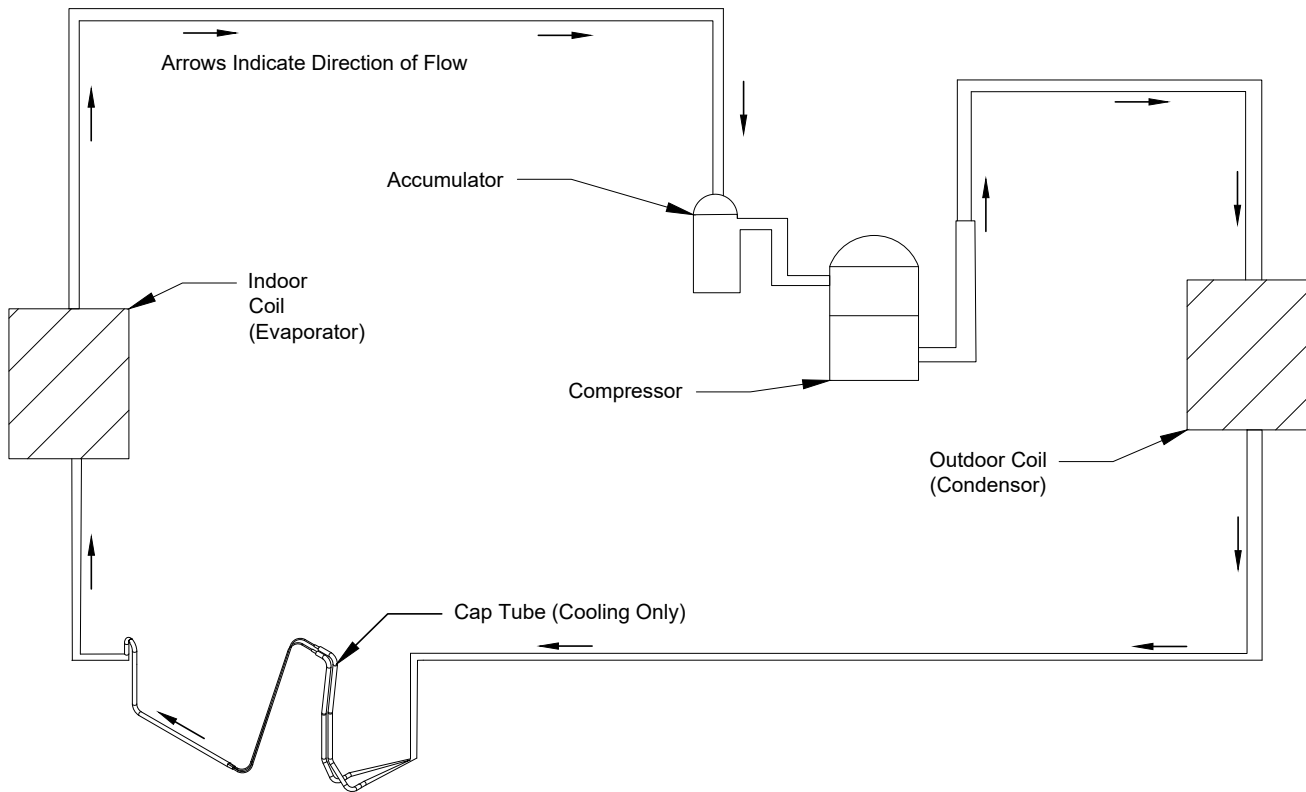



Figure 501 (Cooling Only Refrigerant Flow)

COMPONENT TESTING

Compressor Checks

⚠ WARNING	
	ELECTRIC SHOCK HAZARD Turn off electric power before service or installation. Extreme care must be used, if it becomes necessary to work on equipment with power applied. Failure to do so could result in serious injury or death.

⚠ WARNING	
	HIGH PRESSURE HAZARD Sealed Refrigeration System contains refrigerant and oil under high pressure. Proper safety procedures must be followed, and proper protective clothing must be worn when working with refrigerants. Failure to follow these procedures could result in serious injury or death.

Gain access to the Compressor See Unit Disassembly

1. Remove Compressor Cap.
2. Disconnect terminals U, V, and W from the Compressor).

Resistance Test.

1. Set Ohm meter to the lowest scale and check continuity between pins U, V, and W.

At room temperature (70°- 95°F) the resistance should be approximately 3.5 ohms. The Ohm values will change significantly at different temperatures. This does not indicate that the compressor windings are faulty. A reading of open (infinity), or if resistance between the windings is not the same, **does** indicate that the compressor windings are faulty.

2. Check for continuity from between pins U to ground, V to ground, and U to ground.
The compressor windings are faulty if there is continuity from the compressor windings to ground.

Note:

- Don't put a compressor on its side or turn over.
- Assemble the compressor quickly after removing the plugs. Prolonged exposure will damage the internal components of the compressor
- Ensure wiring is correct before operating. Reverse operation will permanently damage the compressor.

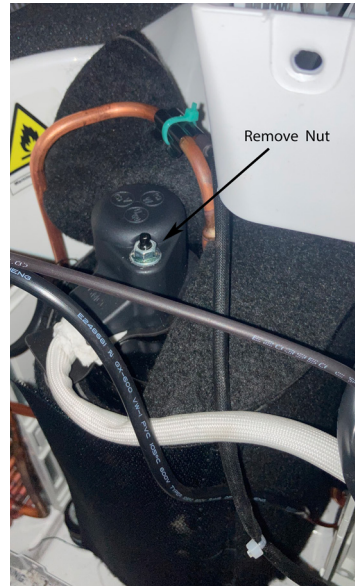

Figure 502



Figure 503

COMPONENT TESTING

Main PCB Identification

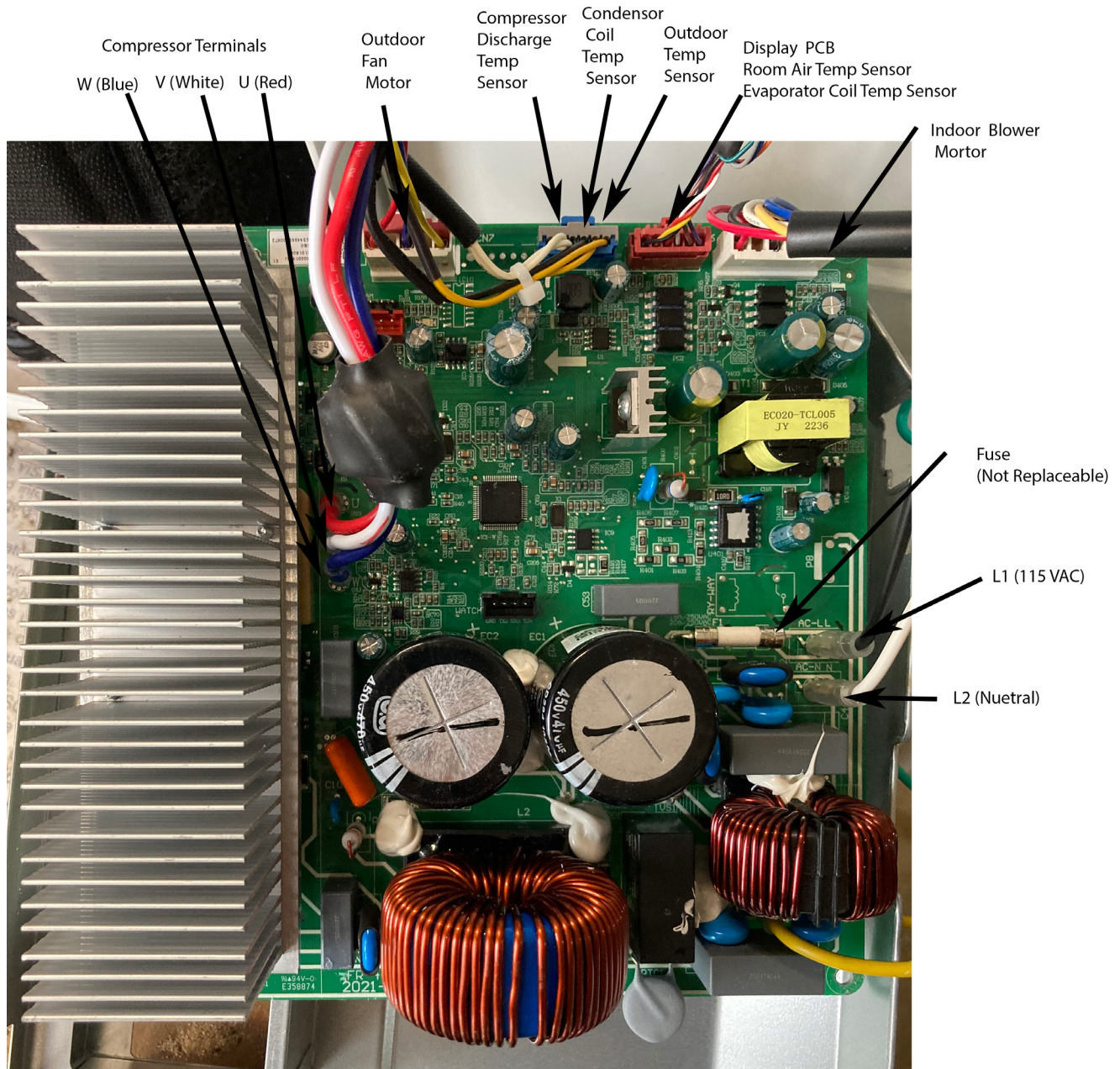

Figure 504

COMPONENT TESTING

Display PCB Identification

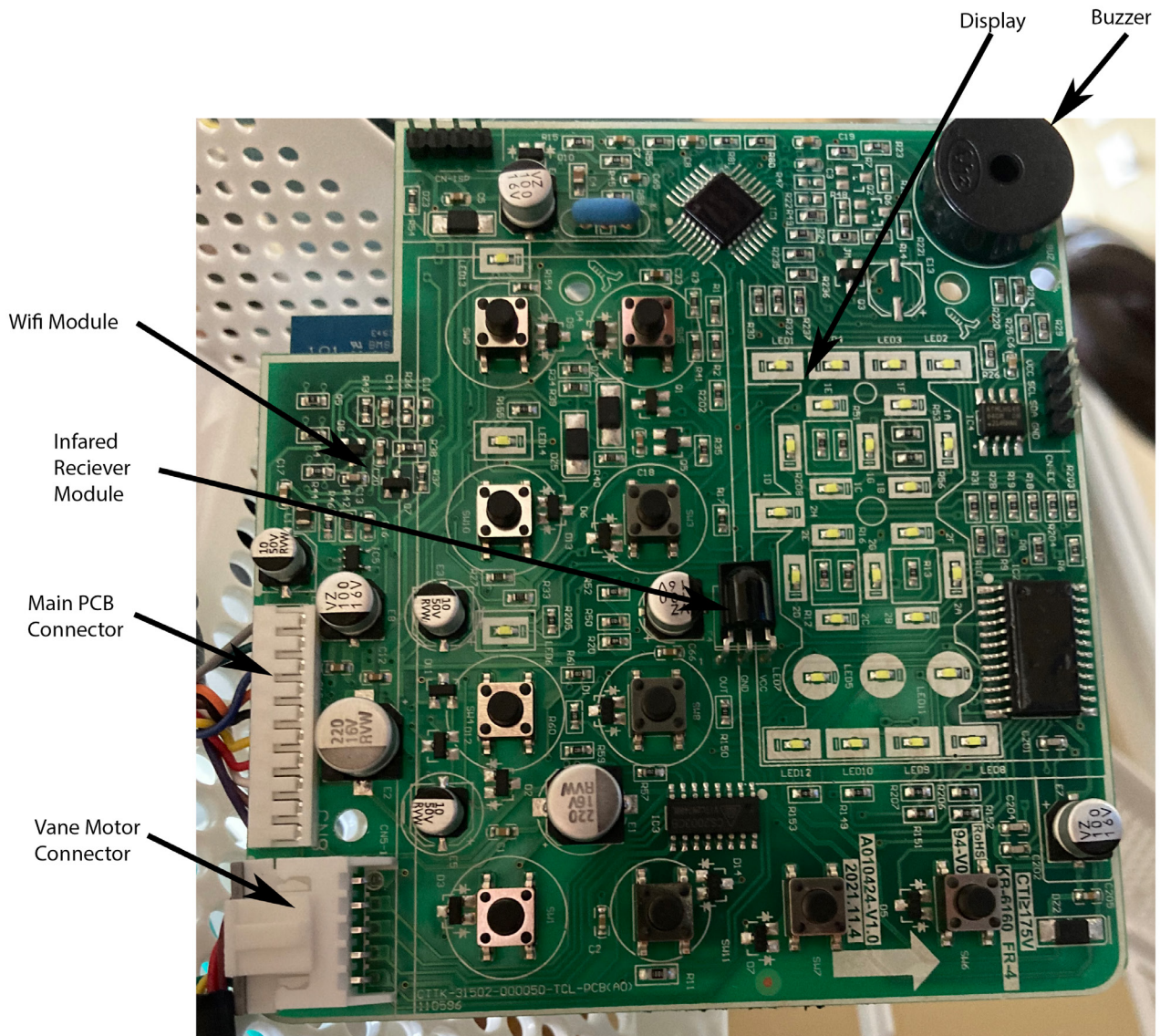
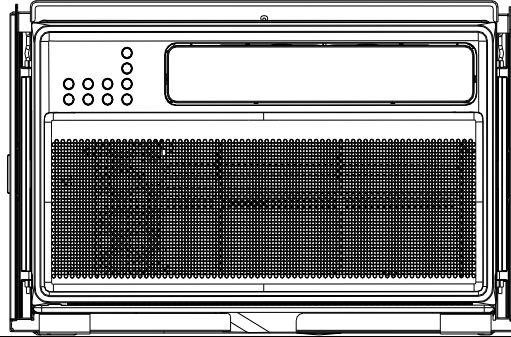

Figure 505

UNIT DISSASSEMBLY

1. Before disassembly

The original status.



2. Disassembly left / right telescopic curtain support assy

Pull the telescopic curtain bracket (left) and telescopic curtain bracket (right), then take them off

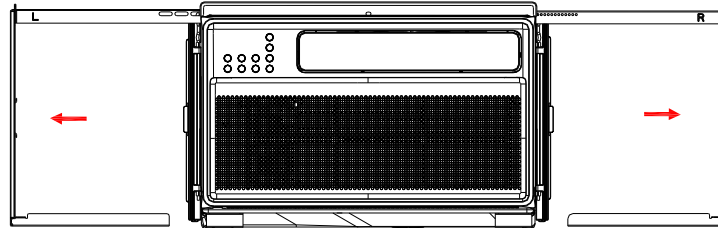

3. Remove rotating shaft and telescopic curtain

Pull out the rotating shafts upwards.
Remove the telescoping curtain.

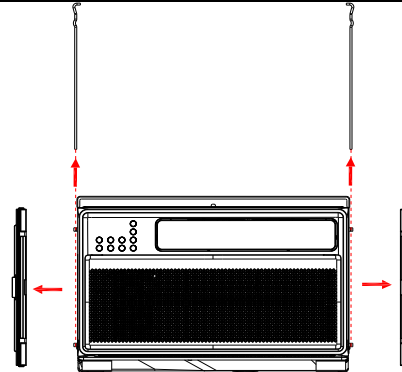

4. Remove the air-inlet grille

Open the air inlet grille outwards, then take it out diagonally upwards.

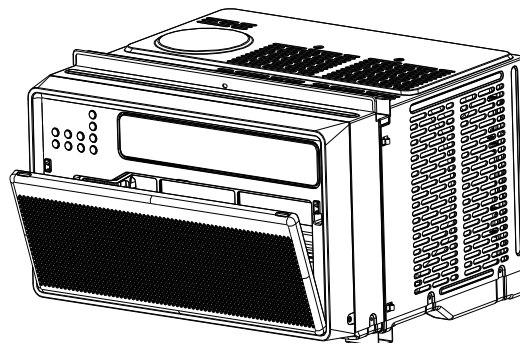

UNIT DISSASSEMBLY

5. Remove the vane, air filter

A. Pull out the Vane. It is attached with three rotating shafts.

B. Take out the air filter.

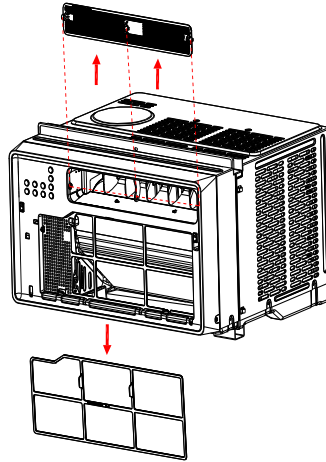

6. Remove panel assy

A. Remove two screws on both sides of panel assy and cabinet assy.

B. Loosen the 8 clasps between the panel assy and cabinet assy.

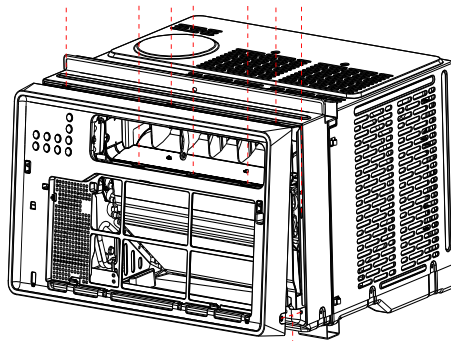

7. Remove the cabinet assy

Remove 10 screws from the cabinet, then lift the cabinet.

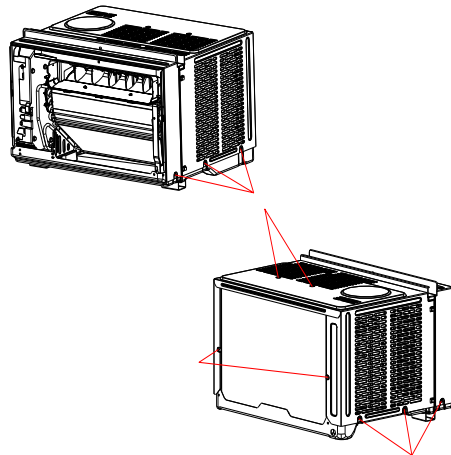

UNIT DISSASSEMBLY

8. Remove the shield box

Remove the two fastening screws of the shield box and pull out the two clasps to remove the shield box

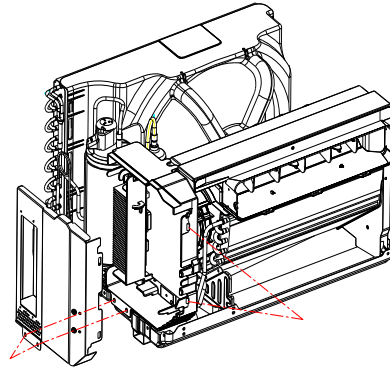

9. Remove the electric box

- A. Remove the screws between the electric box and the middle partition board.
- B. Remove the electric box.

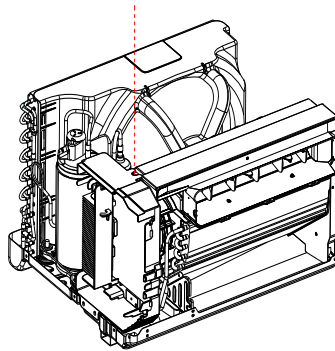

10. Remove the back surround plate assy

- A. Loosen the two screws of the Back surround plate.
- B. Remove the back surround plate assy by pulling it up in the direction is indicated by the arrow.

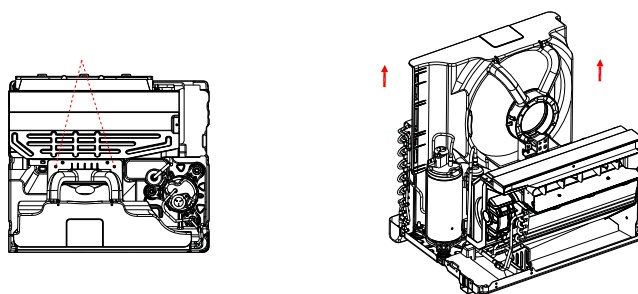

11. Remove the air duct assy

- A. Remove the two screws between the air duct assy and evaporator.
- B. Lift the air duct assy to remove it.

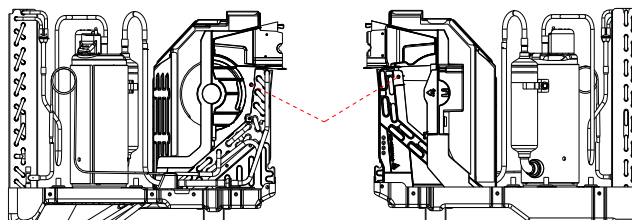

UNIT DISSASSEMBLY

Replace Display PCB and Assembly

Warning: Ensure there are no open flame sources or hot surfaces that exceed 1200°F in the work area.

Warning: Discharge capacitors in a way that won't cause any spark. The standard procedure to short circuit the capacitor terminals usually creates sparks.

1. Remove grill, air filter, and vane from front panel assembly. Refer to Dissassembly instructions.
2. Remove Front Panel . Refer to dissassembly instructions.
3. Remove Cabinet Assy. Refer to dissassembly instructions.
4. Remove Shield Box
5. Disconnect display connector from main PCB. See Figure 601.
6. Disconnect Sensor Connector from Display PCB HarnerSS. See Figure 601.

(Continued)

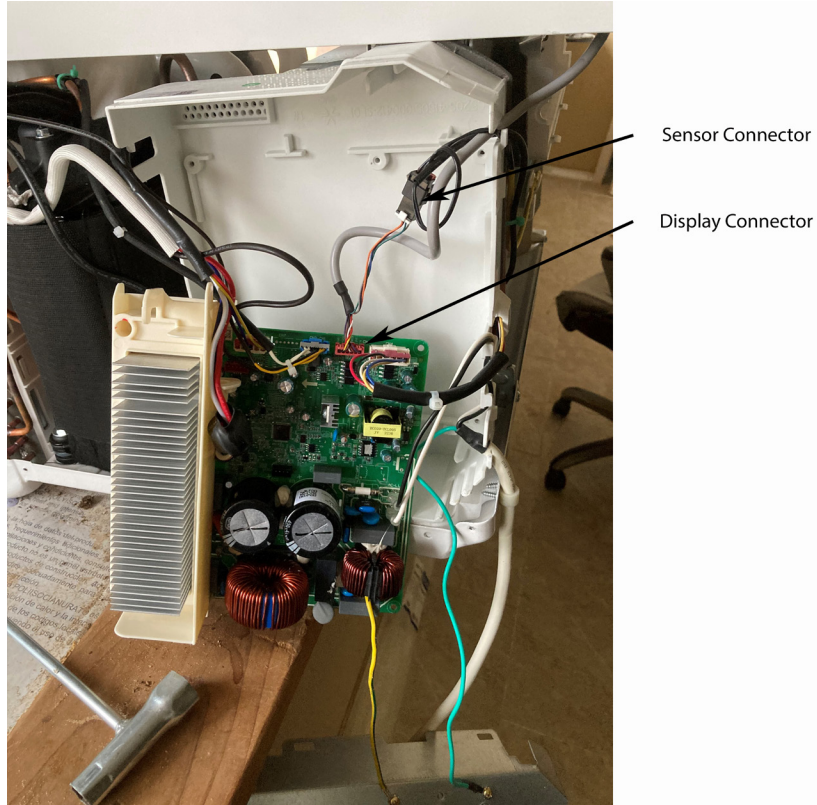

Figure 601

UNIT DISSASSEMBLY

Replace Display PCB and Assembly



Figure 602

7. Remove the 2 screws as shown in figure 602.
8. Depress 2 clips and remove display PCB from display assembly. See figure 602
9. Disconnect the vane motor connector from display PCB shown in figure 603.

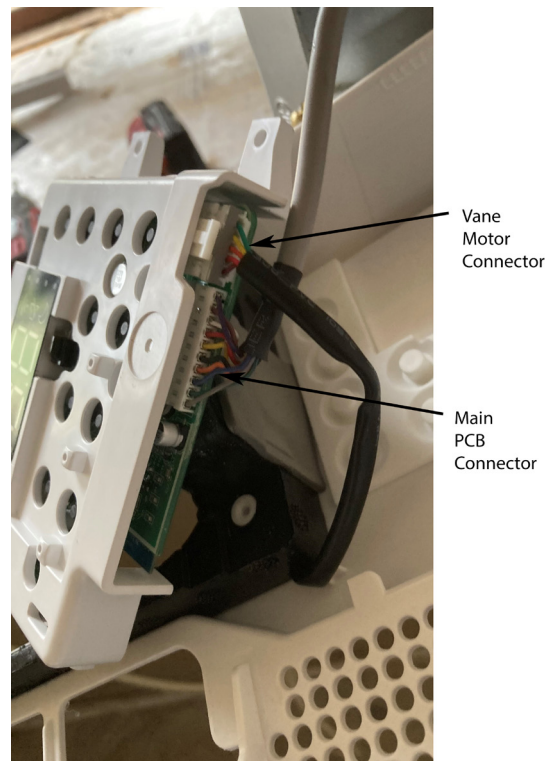

Figure 603

UNIT DISSASSEMBLY

Replace Main PCB

Warning: Ensure there are no open flame sources or hot surfaces that exceed 1200°F in the work area.

Warning: Discharge capacitors in a way that won't cause any spark. The standard procedure to short circuit the capacitor terminals usually creates sparks.

1. Remove grill, air filter, and vane from front panel assembly. Refer to Dissassembly instructions.
2. Remove Front Panel. Refer to dissassembly instructions.
3. Remove Cabinet Assy. Refer to dissassembly instructions.
4. Remove Shield Box



Figure 603

5. Disconnect all plugs and connectors

(Continued)

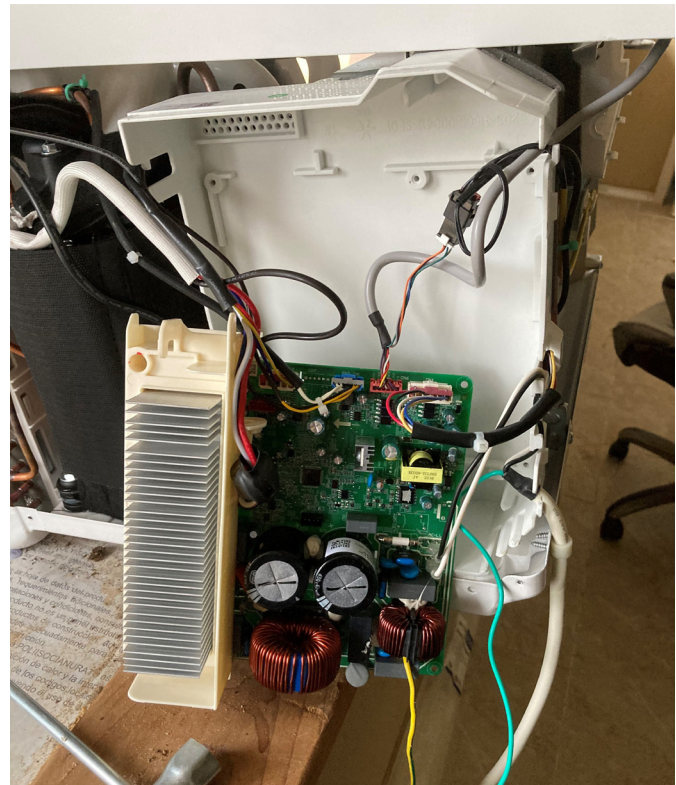

Figure 604

UNIT DISSASSEMBLY

Replace Main PCB

6. Remove Compressor Cap (5/16 nut) and disconnect wires from Compressor. See Figure 605.

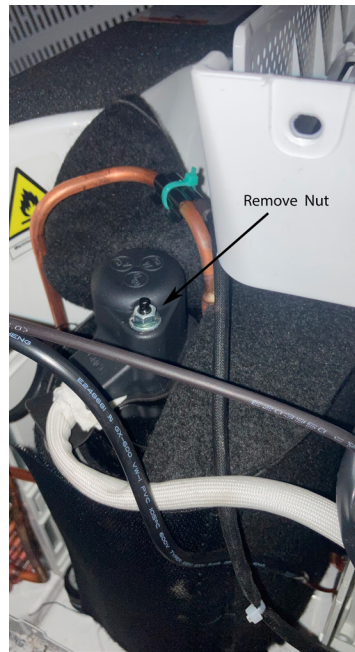

Figure 605

7. Remove Electrical Box and rubber Gasket. See Figure 606.

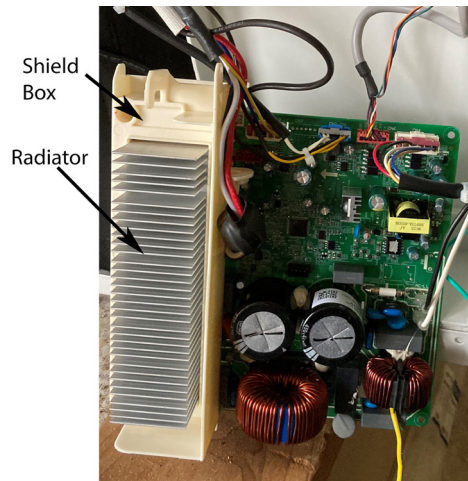

Figure 606

8. Remove Radiator from PCB if required. See Figure 607.

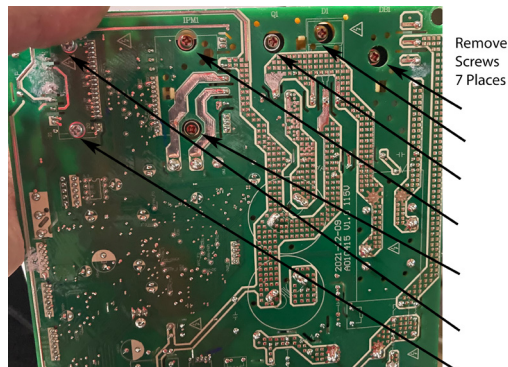

Figure 607

Routine Maintenance

Coils & Chassis

NOTE: Do not use a caustic (alkaline) or acidic cleaning agent on coils or base pan. Use a biodegradable cleaning agent and degreaser. The use of harsh cleaning materials may lead to deterioration of the aluminum fins or the coil end plates.

The indoor coil and outdoor coils and base pan should be inspected periodically (annually or semi-annually) and cleaned of all debris (lint, dirt, leaves, paper, etc.) as necessary. Under extreme conditions, more frequent cleaning may be required. Clean the coils with and base pan with a coil comb or soft brush and compressed air or vacuum. A low pressure washer device may also be used; however, you must be careful not to bend the aluminum fin pack. Use a sweeping up and down motion in the direction of the vertical aluminum fin pack when pressure cleaning coils.

NOTE: It is extremely important to insure that none of the electrical and/or electronic parts of the unit get wet when cleaning. Be sure to cover all electrical components to protect them from water or spray.

Decorative Front

Use a damp (not wet) cloth when cleaning the control area to prevent water from entering the unit, and possibly damaging the electronic control.

The decorative front and the cabinet can be cleaned with warm water and a mild liquid detergent. Do NOT use solvents or hydrocarbon based cleaners such as acetone, naphtha, gasoline, benzene, etc.

The indoor coil can be vacuumed with a dusting attachment if it appears to be dirty. DO NOT BEND FINS. The outdoor coil can be gently sprayed with a garden hose.

The air filter should be inspected periodically and cleaned if needed by vacuuming with a dust attachment or by cleaning in the sink using warm water and a mild dishwashing detergent. Dry the filter thoroughly before reinstalling. Use caution, the coil surface can be sharp.

Fan Motor & Compressor

The fan motor & compressor are permanently lubricated and require no additional lubrication.

Sleeve

Inspect the inside of the sleeve and drain system periodically (annually or semi-annually) and clean as required. Under extreme conditions, more frequent cleaning may be necessary. Clean both of these areas with an antibacterial and antifungal cleaner. Rinse both items thoroughly with water and ensure that the drain outlets are operating correctly. Check the sealant around the sleeve and reseal areas as needed.

Blower Wheel / Housing / Condenser Fan / Shroud

Inspect the indoor blower and its housing, evaporator blade, condenser fan blade and condenser shroud periodically (yearly or bi-yearly) and clean of all debris (lint, dirt, mold, fungus, etc.). Clean the blower housing area and blower wheel with an antibacterial / antifungal cleaner. Use a biodegradable cleaning agent and degreaser on condenser fan and condenser shroud. Use warm or cold water when rinsing these items. Allow all items to dry thoroughly before reinstalling them.

Electrical / Electronic

Periodically (at least yearly or bi-yearly) inspect all control components: electronic, electrical and mechanical, as well as the power supply. Use proper testing instruments (voltmeter, ohmmeter, ammeter, wattmeter, etc.) to perform electrical tests. Use an air conditioning or refrigeration thermometer to check room, outdoor and coil operating temperatures.

Air Filter

To ensure proper unit operation, the air filter should be cleaned at least monthly, and more frequently if conditions warrant. The unit must be turned off before the filter is cleaned.

R-32 SEALED SYSTEM REPAIR

General Information

WARNING: Electrical Shock Hazard

Disconnect all power to the unit before starting maintenance. All electrical connections and wiring MUST be installed by a qualified electrician and conform to all codes which have jurisdiction. Failure to do so can result in property damage, severe electrical shock or death.



WARNING: This Product uses R-32 Refrigerant

Do not use means to accelerate the defrosting process or to clean, other than those recommended by the manufacturer.

When not installed, the appliance shall be stored in a room without continuously operating ignition sources (for example: open flames, an operating gas appliance or an operating electric heater).

Do not pierce or burn.

Be aware that refrigerants may not contain an odor.



Refrigerant
Safety Group
A2L

WARNING: Refrigeration System under High pressure

Do not puncture, heat, expose to flame or incinerate. Only certified refrigeration technicians should service this equipment. R32 systems operate at higher pressures than R22 equipment. Appropriate safe service and handling practices must be used.

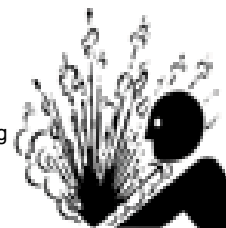

 **Warning:** Prior to beginning work on systems containing FLAMMABLE REFRIGERANTS, safety checks are necessary to ensure that the risk of ignition is minimized.

Work shall be undertaken under a controlled procedure so as to minimise the risk of a flammable gas or vapour being present while the work is being performed

General Work Area: All maintenance staff and others working in the installation area shall be instructed on the nature of work being carried out. Work in confined spaces as defined by the Occupational Safety And Health Administration shall be avoided.

Check for presence of refrigerant:

- The area shall be checked with an appropriate refrigerant detector prior to and during work, to ensure the technician is aware of potentially toxic or flammable atmospheres.
- Ensure that the leak detection equipment being used is suitable for use with all applicable refrigerants, i.e. non-sparking, adequately sealed or intrinsically safe.
- Under no circumstances shall potential sources of ignition be used in the searching for or detection of refrigerant leaks. A halide torch (or any other detector using a naked flame) shall not be used.
- The following leak detection methods are deemed acceptable for all refrigerant systems:
 1. Electronic leak detectors may be used to detect refrigerant leaks but, in the case of FLAMMABLE REFRIGERANTS, the sensitivity may not be adequate, or may need re-calibration. (Detection equipment shall be calibrated in a refrigerant-free area.) Ensure that the detector is not a potential source of ignition and is suitable for the refrigerant used. Leak detection equipment shall be set at a percentage of the LFL of the refrigerant and shall be calibrated to the refrigerant employed, and the appropriate percentage of gas (25 % maximum) is confirmed.
 2. Leak detection fluids are also suitable for use with most refrigerants but the use of detergents containing chlorine shall be avoided as the chlorine may react with the refrigerant and corrode the copper pipe-work.

NOTE: Examples of leak detection fluids are:

- Bubble Method

If a leak is suspected, all flame sources shall be removed/extinguished.

If a leakage of refrigerant is found which requires brazing, all of the refrigerant shall be recovered from the system, or isolated (by means of shut off valves) in a part of the system remote from the leak.

Presence of fire extinguisher: If any hot work is to be conducted on the refrigerating equipment or any associated parts, a class ABC Rated fire extinguishing equipment shall be available to hand. Have a class ABC Rated fire extinguisher adjacent to the charging area.

R-32 SEALED SYSTEM REPAIR

General Information

Warning:

No ignition sources: No person carrying out work in relation to a REFRIGERATING SYSTEM which involves exposing any pipe work shall use any sources of ignition in such a manner that it may lead to the risk of fire or explosion. All possible ignition sources, including cigarette smoking, should be kept sufficiently far away from the site of installation, repairing, removing and disposal, during which refrigerant can possibly be released to the surrounding space. Prior to work taking place, the area around the equipment is to be surveyed to make sure that there are no flammable hazards or ignition risks.

Ventilated Area: Ensure that the area is in the open or that it is adequately ventilated before accessing the refrigerant in the system or conducting any hot work. A degree of ventilation shall continue during the period that the work is carried out. The ventilation should safely disperse any released refrigerant and preferably expel it externally into the atmosphere.

During Repairs To Sealed Components: All power must be removed from the equipment being worked on prior to any removal of sealed covers, etc. If it is absolutely necessary to have an electrical supply to equipment during servicing, then a permanently operating form of leak detection shall be located at the most critical point to warn of a potentially hazardous situation.

Checks And Repairs To Electrical Devices:

- Repair and maintenance to electrical components shall include initial safety checks and component inspection procedures. If a fault exists that could compromise safety, then no electrical supply shall be connected to the circuit until it is satisfactorily dealt with. If the fault cannot be corrected immediately but it is necessary to continue operation, an adequate temporary solution shall be used. This shall be reported to the owner of the equipment so all parties are advised.
- Initial safety checks shall include:
 - That capacitors are discharged: this shall be done in a safe manner to avoid possibility of sparking;
 - That no live electrical components and wiring are exposed while charging, recovering or purging the system;
 - That there is continuity of earth bonding.
- Particular attention shall be paid to the following to ensure that by working on electrical components, the casing is not altered in such a way that the level of protection is affected. This shall include damage to cables, excessive number of connections, terminals not made to original specification, damage to seals, incorrect fitting of glands, etc.
- Ensure that the apparatus is mounted securely.
- Ensure that seals or sealing materials have not degraded to the point that they no longer serve the purpose of preventing the ingress of flammable atmospheres. Replacement parts shall be in accordance with the manufacturer's specifications.
-

The following is a list of important considerations when working with R-32 equipment:

- R-32 pressure is approximately 60% higher than R-22 pressure.
- R-32 cylinders must not be allowed to exceed 125 F, they may leak or rupture.
- R-32 must never be pressurized with a mixture of compressed air, it may become MORE flammable.
- Servicing equipment and components must be specifically designed for use with R-32 and dedicated to prevent contamination.
- Manifold sets must be equipped with gauges capable of reading 750 psig (high side) and 200 psig (low side), with a 500-psig low-side retard.
- Gauge hoses must have a minimum 750-psig service pressure rating.
- Recovery cylinders must have a minimum service pressure rating of 400 psig, (DOT 4BA400 and DOT BW400 approved cylinders).
- POE (Polyol-Ester) lubricants must be used with R-32 equipment.
- To prevent moisture absorption and lubricant contamination, do not leave the refrigeration system open to the atmosphere for extended periods of time.
- If the system is void of refrigerant, weigh-in the refrigerant charge into the high side of the system.
- If there is any amount of refrigerant in the system charge from the low side.
- For low side pressure charging of R-32, use a charging adaptor.

NOTE: Sealed system repairs require the installation of a liquid line drier.

R-32 SEALED SYSTEM REPAIR

Required Equipment

- Multi-meter
- Ammeter
- R-32 E.P.A. Approved Refrigerant Recovery System
- Vacuum Pump rated for R-32 refrigerant (capable of 300 microns or less vacuum.)
- Oxy/ Acetylene torch or similar equipment utilized for brazing.
- Non-Sparking (Not Halide) Electronic Leak Detector rated for detecting R-32 refrigerant.
- Digital refrigerant scale
- High Pressure Gauge - (0 to 750 lbs.)
- Low Pressure Gauge - (-30 to 200 lbs.)
- Vacuum Gauge capable of 300 microns or less.
- Facilities for flowing nitrogen through refrigeration tubing during all brazing processes.

EQUIPMENT MUST BE CAPABLE OF:

- Recovering refrigerant to EPA required levels.
- Evacuation from both the high side and low side of the system simultaneously.
- Introducing refrigerant charge into high side of the system.
- Accurately weighing the refrigerant charge introduced into the system.

R-32 SEALED SYSTEM REPAIR

Refrigerant Removal, Recovery, and Evacuation

NOTE: When accessing the refrigerant in the system to make repairs or for any other purpose, conventional procedures shall be used. However, for FLAMMABLE REFRIGERANTS (R-32 is classified in the A2L group for mildly flammable refrigerants) it is important that best practice is followed since flammability is a consideration.

 **Warning:** Ensure sufficient ventilation at the repair place.

 **Warning:** Ensure there are no open flame sources or hot surfaces that exceed 1200°F in the work area.

 **Warning:** Discharge capacitors in a way that won't cause any spark. The standard procedure to short circuit the capacitor terminals usually creates sparks.

1. Install a piercing valve to remove refrigerant from the sealed system. (Piercing valve must be removed from the system before recharging.)

2. Safely remove refrigerant following local and national regulations. (Refer to local governing bodies for refrigerant handling.)

Recovery

- a. When transferring refrigerant into cylinders, ensure that only appropriate refrigerant recovery cylinders are employed. Ensure that the correct number of cylinders for holding the total system charge is available. All cylinders to be used are designated for the recovered refrigerant and labelled for that refrigerant (i.e. special cylinders for the recovery of refrigerant). Cylinders shall be complete with pressure-relief valve and associated shut-off valves in good working order. Empty recovery cylinders are evacuated and, if possible, cooled before recovery occurs.
- b. Make sure that cylinder is situated on the scales before recovery takes place. The recovery equipment shall be in good working order with a set of instructions concerning the equipment that is at hand and shall be suitable for the recovery of the flammable refrigerant. In addition, a set of calibrated weighing scales shall be available and in good working order. Hoses shall be complete with leak-free disconnect couplings and in good condition.
- c. Do not mix refrigerants in recovery units and especially not in cylinders.
- d. If compressors or compressor oils are to be removed, ensure that they have been evacuated to an acceptable level to make certain that FLAMMABLE REFRIGERANT does not remain within the lubricant. The evacuation process shall be carried out prior to returning the compressor for inspection. Only electric-type heating to the compressor body shall be employed to accelerate this process. When oil is drained from a system, it shall be carried out safely.
- e. Start the recovery machine and operate in accordance with instructions.
- f. Do not overfill cylinders (no more than 80 % volume liquid charge).
- g. Do not exceed the maximum working pressure of the cylinder, even temporarily.
- h. When the cylinders have been filled correctly and the process completed, make sure that the cylinders and the equipment are removed from site promptly and all isolation valves on the equipment are closed off.

3. Purge circuit with inert gas such as nitrogen.

4. Open the circuit by cutting with a refrigeration tubing cutter. Always open the low side first.

The refrigerant charge shall be recovered into the correct recovery cylinders.

Transportation

Be aware that local, state, and national codes exist that regulate the transportation of flammable gases. Be sure to become informed of the regulations and always stay compliant.

R-32 SEALED SYSTEM REPAIR

Component Replacement/Brazing

 **Warning:** Ensure sufficient ventilation at the repair place.

 **Warning:** Presence of fire extinguisher. If any hot work is to be conducted on the refrigerating equipment or any associated parts, have a ABC class fire extinguisher available to hand.

 **Warning:** No person carrying out work in relation to a REFRIGERATING SYSTEM which involves exposing any pipe work shall use any sources of ignition in such a manner that it may lead to the risk of fire or explosion. All possible ignition sources, including cigarette smoking, should be kept sufficiently far away from the site of installation, repairing, removing and disposal, during which refrigerant can possibly be released to the surrounding space. Prior to work taking place, the area around the equipment is to be surveyed to make sure that there are no flammable hazards or ignition risks.

 **Warning:** Ensure there are no open flame sources or hot surfaces that exceed 1200°F in the work area.

NOTE: When brazing is required, the following procedures shall be carried out in the right order:

1. Install a piercing valve to remove refrigerant from the sealed system. (Piercing valve must be removed from the system before recharging.)
2. Remove and recover refrigerant, and evacuate the system. [Refer to the refrigerant removal, recovery, and evacuation](#) section of this manual.
3. Purge circuit with inert gas such as nitrogen.
4. Remove parts to be replaced by cutting, not by flame.
5. Perform a check of the work area for the presence of flammable refrigerant prior to brazing or performing any hot work. Use a non-Sparking (Not Halide)Electronic Leak Detector rated for detecting R-32 refrigerant.

 **Warning:** Under no circumstances shall potential sources of ignition be used in the searching for or detection of refrigerant leaks. A halide torch (or any other detector using a naked flame) shall not be used.

Ensure that the detector is not a potential source of ignition and is A2L certified leak detector.

6. Purge the braze point with nitrogen during the brazing procedure.
7. Pressurize nitrogen to 550 psi and leak test all connections with a leak detection fluid. Repair any leaks found.
8. Reassemble sealed enclosures accurately. If seals are worn, replace them.
9. Install a process tube to sealed system.
10. Charge the system with the amount of refrigerant specified on the model nameplate. [Refer to the refrigerant charging section of this manual for charging procedures.](#)
11. Check safety equipment before putting into service.

R-32 SEALED SYSTEM REPAIRS

Refrigerant Charging

WARNING: Electrical Shock Hazard

Disconnect all power to the unit before starting maintenance. All electrical connections and wiring MUST be installed by a qualified electrician and conform to all codes which have jurisdiction. Failure to do so can result in property damage, severe electrical shock or death.



WARNING: This Product uses R-32 Refrigerant

Do not use means to accelerate the defrosting process or to clean, other than those recommended by the manufacturer.

When not installed, the appliance shall be stored in a room without continuously operating ignition sources (for example: open flames, an operating gas appliance or an operating electric heater).

Do not pierce or burn.

Be aware that refrigerants may not contain an odor.



Refrigerant
Safety Group
A2L

WARNING: Refrigeration System under High pressure

Do not puncture, heat, expose to flame or incinerate. Only certified refrigeration technicians should service this equipment. R32 systems operate at higher pressures than R22 equipment. Appropriate safe service and handling practices must be used.

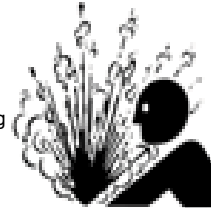

NOTE: Always weigh in refrigerant based on the model nameplate.

Warning:

- Ensure that contamination of different refrigerants does not occur when using charging equipment.
- Hoses or lines shall be as short as possible to minimise the amount of refrigerant contained in them.
- Cylinders shall be kept in an appropriate position according to the instructions.
- Ensure that the REFRIGERATING SYSTEM is grounded prior to charging the system with refrigerant.
- Label the system when charging is complete (if not already).
- Extreme care shall be taken not to overfill the REFRIGERATING SYSTEM.
- Prior to recharging a system, it shall be pressure-tested with the appropriate purging gas. The system shall be leak-tested on completion of charging but prior to commissioning. A follow up leak test shall be carried out prior to leaving the site.
-

NOTE: Because the refrigerant system is a sealed system, service process tubes will have to be installed. First install a line tap and remove refrigerant from system. Refer to the Refrigerant removal section of this manual for procedures. Make necessary sealed system repairs and vacuum system.

The acceptable method for charging the sealed system is the Weighed in Charge Method. The weighed in charge method is applicable to all units. It is the preferred method to use, as it is the most accurate.

The weighed in method should always be used whenever a charge is removed from a unit such as for a leak repair, compressor replacement, or when there is no refrigerant charge left in the unit. To charge by this method, requires the following steps:

R-32 SEALED SYSTEM REPAIRS

Refrigerant Charging

⚠ WARNING	
	BURN HAZARD Proper safety procedures must be followed, and proper protective clothing must be worn when working with a torch. Failure to follow these procedures could result in moderate or serious injury.

⚠ CAUTION	
	FREEZE HAZARD Proper safety procedures must be followed, and proper protective clothing must be worn when working with liquid refrigerant. Failure to follow these procedures could result in minor to moderate injury.

⚠ Warning: Ensure sufficient ventilation at the repair place.

⚠ Warning: Ensure there are no open flame sources or hot surfaces that exceed 1200°F in the work area.

1. Install a piercing valve to remove refrigerant from the sealed system. (Piercing valve must be removed from the system before recharging.)
2. Recover Refrigerant in accordance with EPA regulations. (Refer to Refrigerant Removal, Recovery, and Evacuation Section)
3. Install a process tube to sealed system.

NOTE: Access valves must be removed after charging is complete to return this unit to a sealed system.

4. Evacuate the system to 1500 microns.
5. Repressurize to 50 PSI with nitrogen.
6. Evacuate the system to 1000 microns.
7. Repressurize to 50 PSI with nitrogen.
8. Evacuate the system to below 500 microns.
9. Turn off vacuum pump and confirm microns do not rise above 1000.
10. Weigh in the refrigerant charge with the property quantity of R-32 refrigerant per model nameplate.
11. Start unit, and verify performance.
12. Crimp the process tube and solder the end shut.

NOTE: EPA Section 608 regulations require that if a system is charge with flammable refrigerant it must have red markings on the access ports.

R-32 SEALED SYSTEM REPAIRS

Compressor Replacement

⚠ WARNING	
	<p>ELECTRIC SHOCK HAZARD Turn off electric power before service or installation. Extreme care must be used, if it becomes necessary to work on equipment with power applied.</p> <p>Failure to do so could result in serious injury or death.</p>

⚠ WARNING	
	<p>HIGH PRESSURE HAZARD Sealed Refrigeration System contains refrigerant and oil under high pressure.</p> <p>Proper safety procedures must be followed, and proper protective clothing must be worn when working with refrigerants.</p> <p>Failure to follow these procedures could result in serious injury or death.</p>

⚠ WARNING	
	<p>EXPLOSION HAZARD The use of nitrogen requires a pressure regulator. Follow all safety procedures and wear protective safety clothing etc.</p> <p>Failure to follow proper safety procedures could result in serious injury or death.</p>

⚠ CAUTION	
	<p>FREEZE HAZARD Proper safety procedures must be followed, and proper protective clothing must be worn when working with liquid refrigerant.</p> <p>Failure to follow these procedures could result in minor to moderate injury.</p>

⚠ WARNING	
	<p>NEVER, under any circumstances, liquid charge a rotary-compressor through the LOW side. Doing so would cause permanent damage to the new compressor. Use a charging adapter.</p>

1. Be certain to perform all necessary electrical and refrigeration tests to be sure the compressor is actually defective before replacing.

2. Recover all refrigerant from the system through the process tubes. Refer to [Refrigerant Removal, Recovery, and Evacuation](#) Section of this manual).

PROPER HANDLING OF RECOVERED REFRIGERANT ACCORDING TO EPA REGULATIONS IS REQUIRED.

3. After all refrigerant has been recovered, disconnect suction and discharge lines from the compressor and remove compressor. Be certain to have both suction and discharge process tubes open to atmosphere.

4. Carefully pour a small amount of oil from the suction stub of the defective compressor into a clean container.

5. Using an acid test kit (one shot or conventional kit), test the oil for acid content according to the instructions with the kit.

6. If any evidence of a burnout is found, no matter how slight, refer to Compressor Replacement -Special Procedure in Case of Compressor Burnout.

7. Install the replacement compressor.

CAUTION: Seal all openings on the defective compressor immediately. Compressor manufacturers will void warranties on units received not properly sealed. Do not distort the manufacturers tube connections.

8. Braze all connections. Refer to the Brazing section of this manual.

9. Pressurize with nitrogen to 550 psi and leak test all connections with a leak detection fluid. Repair any leaks found.

10. Charge system with proper amount of refrigerant per the model nameplate. Refer to the [refrigerant charging section of this manual](#).

R-32 SEALED SYSTEM REPAIRS

Compressor Replacement -Special Procedure in Case of Compressor Burnout

⚠ WARNING	
	<p>HIGH PRESSURE HAZARD Sealed Refrigeration System contains refrigerant and oil under high pressure.</p>
	<p>Proper safety procedures must be followed, and proper protective clothing must be worn when working with refrigerants.</p>
	<p>Failure to follow these procedures could result in serious injury or death.</p>

⚠ WARNING	
	<p>ELECTRIC SHOCK HAZARD Turn off electric power before service or installation. Extreme care must be used, if it becomes necessary to work on equipment with power applied.</p>
	<p>Failure to do so could result in serious injury or death.</p>

⚠ WARNING	
	<p>EXPLOSION HAZARD The use of nitrogen requires a pressure regulator. Follow all safety procedures and wear protective safety clothing etc.</p>
	<p>Failure to follow proper safety procedures could result in serious injury or death.</p>

⚠ WARNING	
	<p>NEVER, under any circumstances, liquid charge a rotary-compressor through the LOW side. Doing so would cause permanent damage to the new compressor. Use a charging adapter.</p>

1. Recover all refrigerant and oil from the system. [Refer to Refrigerant Removal, Recovery, and Evacuation Section of this manual.](#)

2. Remove compressor, capillary tube and filter drier from the system.

CAUTION: Seal all openings on the defective compressor immediately. Compressor manufacturers will void warranties on units received not properly sealed. Do not distort the manufacturers tube connections.

3. Flush evaporator condenser and all connecting tubing with dry nitrogen or equivalent. Use approved flushing agent to remove all contamination from system. Inspect suction and discharge line for carbon deposits. Remove and clean if necessary. Ensure all acid is neutralized.

4. Reassemble the system, including new drier strainer and capillary tube.

5. Braze all connections. Refer to the Brazing section of this manual.

6. Pressurize with nitrogen to 550 psi and leak test all connections with a leak detection fluid. Repair any leaks found.

Repeat Step 6 to insure no more leaks are present.

7. Charge system with proper amount of refrigerant per the model nameplate. [Refer to the refrigerant charging section of this manual.](#)

WIRING DIAGRAMS

CCV08A10A, CCV10A10A, CCV12A10A

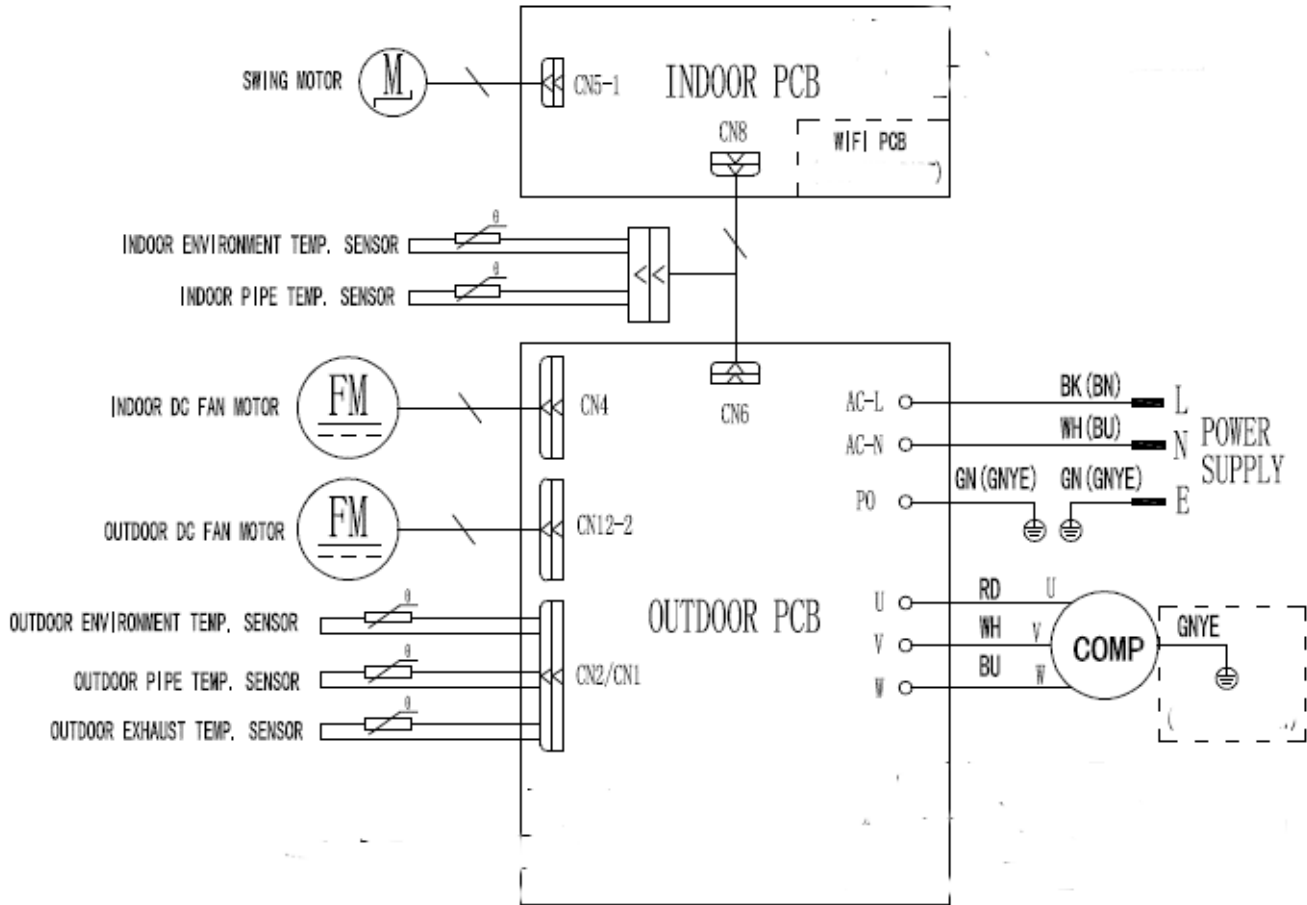

Figure 801

APPENDIX

Appendix 1 Resistance Table of Thermistors (5K)(Ambient and Coil Sensors)

Temp	Resis	Temp	Resis	Temp	Resis	Temp	Resis	Temp	Resis
-33	130100	7	34252	47	10785	57	8275	97	3119
-32	125518	8	33209	48	10499	58	8063	98	3048
-31	121114	9	32202	49	10221	59	7857	99	2980
-30	116881	10	31228	50	9952	60	7657	100	2913
-29	112811	11	30288	51	9690	61	7462	101	2848
-28	108898	12	29378	52	9437	62	7273	102	2785
-27	105131	13	28499	53	9190	63	7090	103	2723
-26	101511	14	27650	54	8952	64	6911	104	2662
-25	98029	15	26828	55	8720	65	6738	105	2604
-24	94676	16	26034	56	8494	66	6569	106	2546
-23	91453	17	25266	57	8275	67	6406	107	2491
-22	88349	18	24523	58	8063	68	6247	108	2436
-21	85362	19	23805	59	7857	69	6092	109	2383
-20	82486	20	23110	60	7657	70	5942	110	2331
-19	79719	21	22437	61	7462	71	5796	111	2281
-18	77052	22	21787	62	7273	72	5654	112	2231
-17	74486	23	21158	63	7090	73	5515	113	2183
-16	72014	24	20548	64	6911	74	5381	114	2137
-15	69633	25	19959	65	6738	75	5251	115	2091
-14	67338	26	19388	66	6569	76	5124	116	2046
-13	65127	27	18836	67	6406	77	5000	117	2003
-12	62996	28	18301	68	6247	78	4880	118	1960
-11	60943	29	17783	69	6092	79	4763	119	1919
-10	58965	30	17282	70	5942	80	4649	120	1878
-9	57055	31	16796	71	5796	81	4538	121	1839
-8	55216	32	16325	72	5654	82	4431	122	1800
-7	53442	33	15870	73	5515	83	4326	123	1763
-6	51732	34	15428	74	5381	84	4224	124	1726
-5	50082	35	15001	75	5251	85	4125	125	1690
-4	48490	36	14586	76	5124	86	4028	126	1655
-3	46955	37	14184	77	5000	87	3934	127	1621
-2	45473	38	13795	48	10499	88	3842	128	1588
-1	44044	39	13418	49	10221	89	3753	129	1555
0	42664	40	13052	50	9952	90	3666	130	1524
1	41332	41	12698	51	9690	91	3582	131	1493
2	40047	42	12354	52	9437	92	3499	132	1462
3	38805	43	12021	53	9190	93	3419	133	1433
4	37607	44	11698	54	8952	94	3341	134	1404
5	36450	45	11384	55	8720	95	3265	135	1375
6	35332	46	11080	56	8494	96	3191	136	1348

APPENDIX

Appendix 2 Resistance Table of Thermistors (20K)(Compressor Discharge Sensor)

Temp. (°F)	Resistance (kΩ)	Temp. (°F)	Resistance (kΩ)	Temp. (°F)	Resistance (kΩ)	Temp. (°F)	Resistance (kΩ)
-2.2	181.4	68	25.01	138.2	5.13	208.4	1.427
-0.4	171.4	69.8	23.9	140	4.948	210.2	1.386
1.4	162.1	71.6	22.85	141.8	4.773	212	1.346
3.2	153.3	73.4	21.85	143.6	4.605	213.8	1.307
5	145	75.2	20.9	145.4	4.443	215.6	1.269
6.8	137.2	77	20	147.2	4.289	217.4	1.233
8.6	129.9	78.8	19.14	149	4.14	219.2	1.198
10.4	123	80.6	18.13	150.8	3.998	221	1.164
12.2	116.5	82.4	17.55	152.6	3.861	222.8	1.131
14	110.3	84.2	16.8	154.4	3.729	224 3/5	1.099
15.8	104.6	86	16.1	156.2	3.603	226.4	1.069
17.6	99.13	87.8	15.43	158	3.481	228.2	1.039
19.4	94	89.6	14.79	159.8	3.364	230	1.01
21.2	89.17	91.4	14.18	161.6	3.252	231.8	0.983
23	84.61	93.2	13.59	163.4	3.144	233.6	0.956
24.8	80.31	95	13.04	165.2	3.04	235.4	0.93
26.6	76.24	96.8	12.51	167	2.94	237.2	0.904
28.4	72.41	98.6	12	168.8	2.844	239	0.88
30.2	68.79	100.4	11.52	170.6	2.752	240.8	0.856
32	65.37	102.2	11.06	172.4	2.663	242.6	0.833
33.8	62.13	104	10.62	174.2	2.577	244.4	0.811
35.6	59.08	105.8	10.2	176	2.495	246.2	0.77
37.4	56.19	107.6	9.803	177.8	2.415	248	0.769
39.2	53.46	109.4	9.42	179.6	2.339	249.8	0.746
41	50.87	111.2	9.054	181.4	2.265	251.6	0.729
42.8	48.42	113	8.705	183.2	2.194	253.4	0.71
44.6	46.11	114.8	8.37	185	2.125	255.2	0.692
46.4	43.92	116.6	8.051	186.8	2.059	257	0.674
48.2	41.84	118.4	7.745	188.6	1.996	258.8	0.658
50	39.87	120.2	7.453	190.4	1.934	260.6	0.64
51.8	38.01	122	7.173	192.2	1.875	262.4	0.623
53.6	36.24	123.8	6.905	194	1.818	264.2	0.607
55.4	34.57	125.6	6.648	195.8	1.736	266	0.592
57.2	32.98	127.4	6.403	197.6	1.71	267.8	0.577
59	31.47	129.2	6.167	199.4	1.658	269.6	0.563
60.8	30.04	131	5.942	201.2	1.609	271.4	0.549
62.6	28.68	132 4/5	5.726	203	1.561	273.2	0.535
64.4	27.39	134.6	5.519	204.8	1.515	275	0.521
66.2	26.17	136.4	5.32	206.6	1.47	276.8	0.509

APPENDIX

Appendix 3 Decommissioning Of Units

Before carrying out this procedure, it is essential that the technician is completely familiar with the equipment and all its detail. It is recommended good practice that all refrigerants are recovered safely and tested prior to re-use.

NOTE: When breaking into the refrigerant circuit to make repairs or for any other purpose, conventional procedures shall be used. However, for FLAMMABLE REFRIGERANTS (R-32 is classified in the A2L group for mildly flammable refrigerants) it is important that best practice is followed since flammability is a consideration.

 **Warning:** Ensure sufficient ventilation at the repair place.

 **Warning:** Ensure there are no open flame sources or hot surfaces that exceed 1200°F in the work area.

 **Warning:** Discharge capacitors in a way that won't cause any spark. The standard procedure to short circuit the capacitor terminals usually creates sparks.

1. Become familiar with the equipment and its operation.
2. Isolate system electrically.
3. Before attempting the procedure, ensure that:
 - mechanical handling equipment is available, if required, for handling refrigerant cylinders.
 - all personal protective equipment is available and being used correctly.
 - the recovery process is supervised at all times by a competent person.
 - recovery equipment and cylinders conform to the appropriate standards.
4. Install a piercing valve to remove refrigerant from the sealed system.
5. Safely remove refrigerant following local and national regulations. [Refer to refrigerant removal, recovery, and evacuation section of this manual.](#)

6. Labelling

Equipment shall be labelled stating that it has been de-commissioned and emptied of refrigerant. The label shall be dated and signed. For appliances containing FLAMMABLE REFRIGERANTS, ensure that there are labels on the equipment stating the equipment contains FLAMMABLE REFRIGERANT.



Friedrich Air Conditioning Company
10001 Reunion Place, Suite 500
San Antonio, TX 78216
800-541-6645
www.friedrich.com

ROOM AIR CONDITIONERS LIMITED WARRANTY

FIRST YEAR

ANY PART: If any part supplied by FRIEDRICH fails because of a defect in workmanship or material within twelve months from date of original purchase, FRIEDRICH will repair the product at no charge, provided room air conditioner is reasonably accessible for service. Any additional labor cost for removing inaccessible units and/or charges for mileage related to travel by a Service Agency that exceeds 25 miles one way will be the responsibility of the owner. This remedy is expressly agreed to be the exclusive remedy within twelve months from the date of the original purchase.

SECOND THROUGH FIFTH YEAR

SEALED REFRIGERANT SYSTEM: If the Sealed Refrigeration System (defined for this purpose as the compressor, condenser coil, evaporator coil, reversing valve, check valve, capillary, filter drier, and all interconnecting tubing) supplied by FRIEDRICH in your Room Air Conditioner fails because of a defect in workmanship or material within sixty months from date of purchase, FRIEDRICH will pay a labor allowance of \$100 and parts necessary to repair the Sealed Refrigeration System; PROVIDED FRIEDRICH will not pay any additional labor charges over the prescribed labor allowance including the cost of diagnosis of the problem, removal, freight charges, and transportation of the air conditioner to and from the Service Agency, and the reinstallation charges associated with repair of the Sealed Refrigeration System. All such cost will be the sole responsibility of the owner. This remedy is expressly agreed to be the exclusive remedy within sixty months from the date of the original purchase.

APPLICABILITY AND LIMITATIONS: This warranty is applicable only to units retained within the Fifty States of the U.S.A., District of Columbia, and Canada. This warranty is not applicable to:

1. Air filters, fuses, batteries and the front grille removal tool.
2. Products on which the model and serial numbers have been removed.
3. Products which have defects or damage which results from improper installation, wiring, electrical current characteristics, or maintenance; or caused by accident, misuse or abuse, fire, flood, alterations and/or misapplication of the product and/or units installed in a corrosive atmosphere, default or delay in performance caused by war, government restrictions or restraints, strikes, material shortages beyond the control of FRIEDRICH, or acts of God.

OBTAINING WARRANTY PERFORMANCE: Service will be provided by the FRIEDRICH Authorized Dealer or Service Organization in your area. They are listed in the Yellow Pages. If assistance is required in obtaining warranty performance, write to: Room Air Conditioner Service Manager (the Friedrich address is at the top of this warranty) or email tac@friedrich.com.

LIMITATIONS: THIS WARRANTY IS GIVEN IN LIEU OF ALL OTHER WARRANTIES. Anything in the warranty notwithstanding, ANY IMPLIED WARRANTIES OF FITNESS FOR PARTICULAR PURPOSE AND/OR MERCHANTABILITY SHALL BE LIMITED TO THE DURATION OF THIS EXPRESS WARRANTY. MANUFACTURER EXPRESSLY DISCLAIMS AND EXCLUDES ANY LIABILITY FOR CONSEQUENTIAL OR INCIDENTAL DAMAGE FOR BREACH OF ANY EXPRESSED OR IMPLIED WARRANTY.

Performance of Friedrich's Warranty obligation is limited to one of the following methods:

1. Repair of the unit
2. A refund to the customer for the prorated value of the unit based upon the remaining warranty period of the unit.
3. Providing a replacement unit of equal value

The method of fulfillment of the warranty obligation is at the sole discretion of Friedrich Air Conditioning.

NOTE: Some states do not allow limitations on how long an implied warranty lasts, or do not allow the limitation or exclusion of consequential or incidental damages, so the foregoing exclusions and limitations may not apply to you.

OTHER: This warranty gives you specific legal rights, and you may also have other rights which vary from state to state.

PROOF OF PURCHASE: Owner must provide proof of purchase in order to receive any warranty related services.

All service calls for explaining the operation of this product will be the sole responsibility of the consumer.

All warranty service must be provided by an **Authorized FRIEDRICH Service Agency**, unless authorized by FRIEDRICH prior to repairs being made.

CUSTOMER SATISFACTION and QUALITY ASSURANCE

Friedrich is a conscientious manufacturer, concerned about customer satisfaction, product quality, and controlling warranty costs. As an Authorized Service Provider you play a vital role in these areas. By adhering to the policies and procedures you provide us with vital information on each warranty repair you complete. This information is used to identify product failure trends, initiate corrective action, and improve product quality, thereby further reducing warranty expenses while increasing customer satisfaction levels.

FRIEDRICH AUTHORIZED PARTS DEPOTS

United Products Distributors Inc.

4030A Benson Ave
Halethorpe, MD 21227
888-907-9675
c.businsky@updinc.com

Shivani Refrigeration & Air Conditioning Inc.

2259 Westchester Ave.
Bronx, NY 10462
sales@shivanionline.com

The Gabbert Company

6868 Ardmore
Houston, Texas 77054

713-747-4110
800-458-4110

Johnstone Supply of Woodside

27-01 Brooklyn Queens Expway
Woodside, New York 11377

718-545-5464
800-431-1143

Reeve Air Conditioning, Inc.

2501 South Park Road
Hallandale, Florida 33009

954-962-0252
800-962-3383

Total Home Supply

26 Chapin Rd Ste 1109
Pine Brook, NJ 07058
877-847-0050

support@totalhomesupply.com
<https://www.totalhomesupply.com/brands/Friedrich.html>



FRIEDRICH

TECHNICAL SUPPORT CONTACT INFORMATION

Friedrich Air Conditioning Co.
10001 Reunion Place, Suite 500 • San Antonio, Texas 78216
1-800-541-6645
www.friedrich.com