

# 90 ALBERTINE DUAL FUEL: C9

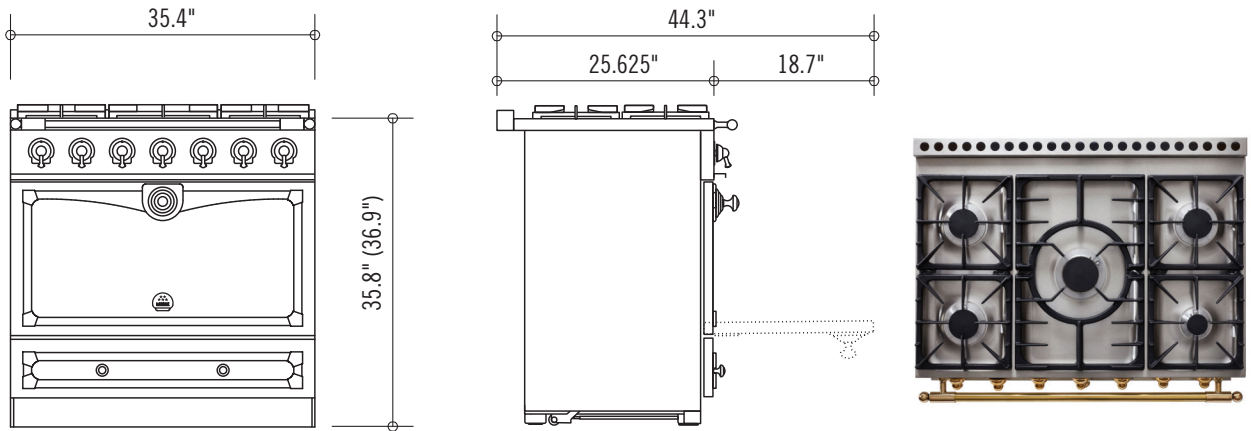

Designed especially for the US market, the single oven “Albertine” range is the baby of the CornuFé family. With one large multi-function convection oven, and seven unique cooking modes, the range has five powerful brass gas burners and one large storage drawer. The CornuFé 90 is available in eleven colors and 3 trim accent choices of Polished Brass, Satin Chrome and Polished Chrome.



## SPECIFICATIONS

### CORNUFÉ 90 “ALBERTINE”<sup>®</sup>: C9

900 W x 650.875 D x 910 (937 max) H (mm)  
 35.4 W x 25.625 D x 35.8 (36.9 max) H (inches)  
 315 lb. uncrated, 410 lb. crated  
 High-performance 5 burner gas cooktop  
 Large electric convection oven

#### Gas Burners:

1 17,500 BTU Central Burner  
 3 12,000 BTU Burners  
 1 6,000 BTU Simmer Burner  
 Solid Brass Enamel-Capped Burners with Thermocouple Safety Mechanism

#### Ovens:

Enameled steel door with glass inner door  
 Electric convection oven featuring 7 cooking modes  
 2 Convection Fans, 8 Heating Elements  
 1 Wire Rack  
 1 Large Tray Equipped with Broil Pan  
 1 Pastry Tray  
 1 Telescopic Rack  
 714 W x 389 D x 381 H (mm)  
 28.1 W x 15.3 D x 15 H (inches)  
 3.81 cubic feet

## POWER AND FUEL

Voltage: 240v; 60Hz, 16 AMP  
 Gas connection: 1/2 inch NPT at rear left-hand side  
 Natural gas range with propane conversion kit included

## HIGH-ALTITUDE KIT

Required for elevations above 5,000 feet  
**Natural Gas High-Altitude Kit “A037977”**  
**Propane High-Altitude Kit “A037982”**

## FINISHES

**Five Classic Colors:** Matte Black, Stainless Steel, Gloss Black, Provence Blue, and Pure White

**Four Étoile Colors:** Morning Dew, Graphite, Ocean, and Wintersky

**Suzanne Kasler Color Collection Colors:** Tapestry and Roquefort

**Three Trim Options:** 1) Stainless Steel Trim and Rail with Satin Chrome Accents, 2) Stainless Steel Trim with Polished Brass Rail and Accents, and 3) Stainless Steel Trim, Polished Stainless Steel Rail, with Polished Chrome Accents

NOTE: Side panels are stainless steel for all colors except Gloss Black and Matte Black ranges have flat black side panels. The Polished Brass Trim is natural, non coated metal and will patina over time.



# 90 ALBERTINE: C9

## CORNUFÉ HOOD COLLECTION

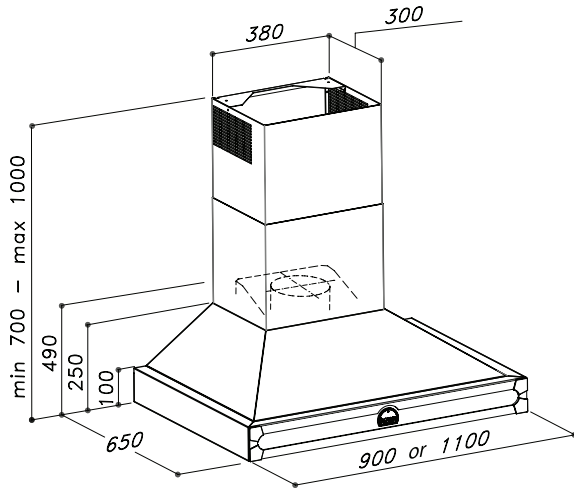

### CORNUFÉ 90 HOOD: H9

- 900 W x 650 D x 700 H (mm)
- 35.4 W x 25.6 D x 27.5 H (inches)
- Traditional wall-mounted chimney hood
- Available in all color and trim options
- 4-Speed Variable Motor
- One 600 CFM blower – unobstructed air flow with Ø6" duct
- Remote Control and In-Hood Activation Controls
- Three 20W high-intensity lights
- 2 dishwasher-safe baffle filters with grease capture system
- Voltage: 120v; 60Hz, total rating: 425W, 3.6 AMP
- Telescopic flue cover extends to maximum hood height of 39.3" (1000 mm)

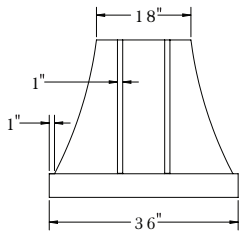

FRONT VIEW

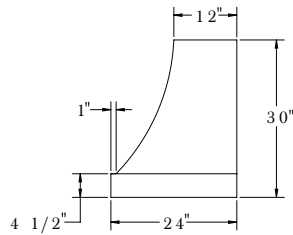

SIDE VIEW

### CORNUFÉ CASCADE : CH3630CAC & CH4430CAC

- Hood Style: Concave
- Available in both 36" & 44"
- 36"W x 24"D x 30"H (600 cfm/8" collar)
- 44"W x 24"D x 30"H (1200 cfm/10" collar)

- Duct Cover Options:
- 12", 24" and 48" Tall
- Custom Duct Cover heights are available*

- Product Weight:
- 36"(30"H) : 97 lbs
- 44"(30"H) : 124 lbs

- Electrical Requirements:
- 600 CFM models draw approx. 2.7 Amps
- 1200 CFM models draw approx. 5.4 Amps

- Hood Sone Level:
- Ranges from 5-7

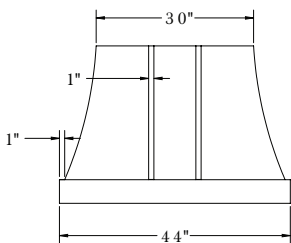

FRONT VIEW

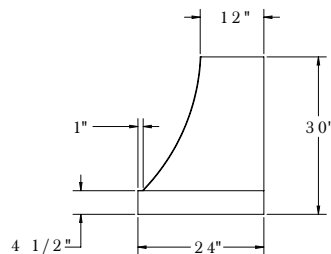

SIDE VIEW



# 90 ALBERTINE: C9

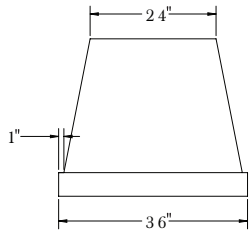

FRONT VIEW

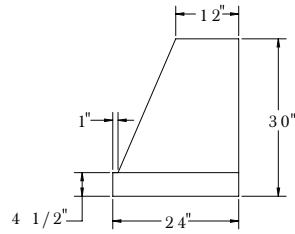

SIDE VIEW

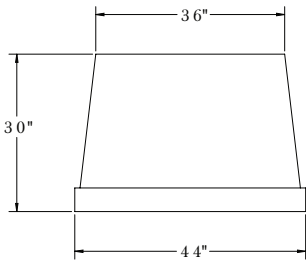

FRONT VIEW

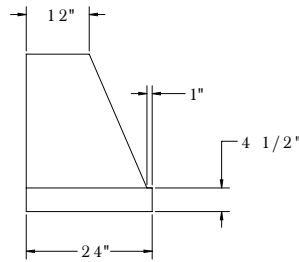

SIDE VIEW

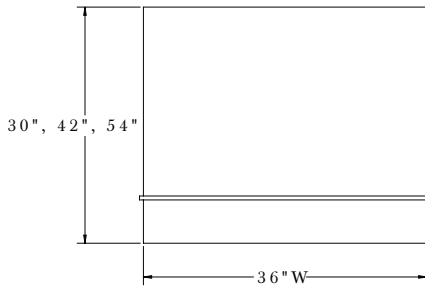

FRONT VIEW

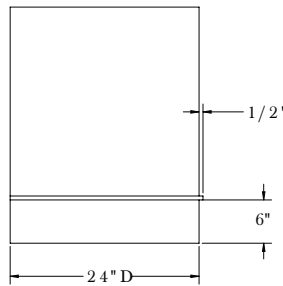

SIDE VIEW

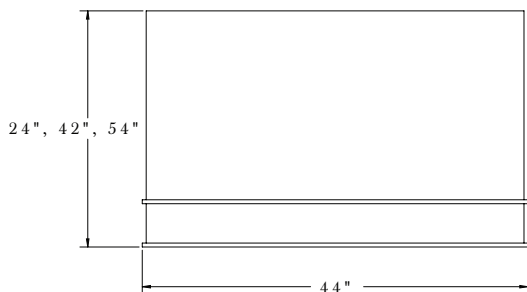

FRONT VIEW

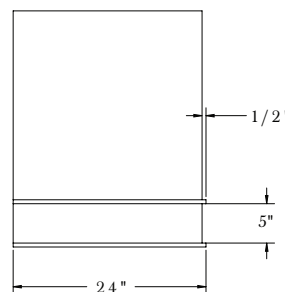

SIDE VIEW

## CORNUFÉ EUCLID : CH3630EUC & CH4430EUC

Hood Style: Trapezoid

Available in both 36" & 44"  
 36"W x 24"D x 30"H (600 cfm/8" collar)  
 44"W x 24"D x 30"H (1200 cfm/10" collar)

Duct Cover Options:  
 12", 24" and 48" Tall  
*Custom Duct Cover heights are available*

Product Weight: 36"(30"H) : 98 lbs/ 44"(30"H) : 126 lbs

Electrical Requirements:  
 600 CFM models draw approx. 2.7 Amps  
 1200 CFM models draw approx. 5.4 Amps

Hood Sone Level:  
 Ranges from 5-7

## CORNUFÉ LOGE : CH3630LGE & CH4430LGE

Hood Style: Box

Available in both 36" & 44"  
 36"W x 24"D x 30"H, 42"H or 54"H (600 cfm/8" collar)  
 44"W x 24"D x 30"H, 42"H or 54"H (1200 cfm/10" collar)

Product Weight:  
 36"(30"H) : 104 lbs / 36"(42"H) : 122 lbs / 36"(54"H) : 141 lbs  
 44"(30"H) : 130 lbs / 44"(42"H) : 151 lbs / 44"(54"H) : 172 lbs

Electrical Requirements:  
 600 CFM models draw approx. 2.7 Amps  
 1200 CFM models draw approx. 5.4 Amps

Hood Sone Level:  
 Ranges from 5-7



# 90 ALBERTINE: C9

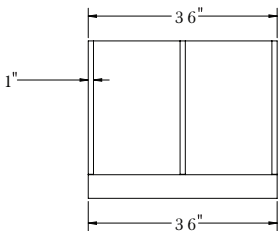

FRONT VIEW

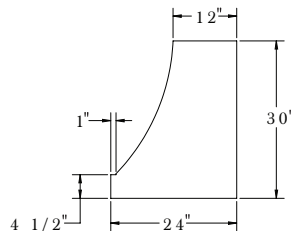

SIDE VIEW

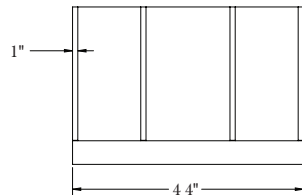

FRONT VIEW

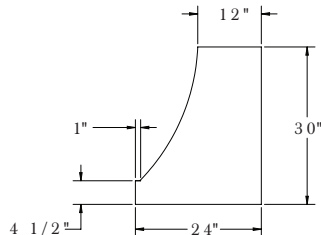

SIDE VIEW

**CORNUFÉ MARQUEE** : CH3630MRQ & CH4430MRQ

Hood Style: Arched Front

Available in both 36" & 44"  
 36"W x 24"D x 30"H (600 cfm/8" collar)  
 44"W x 24"D x 30"H (1200 cfm/10" collar)

Duct Cover Options:  
 12", 24" and 48" Tall  
*Custom Duct Cover heights are available*

Product Weight: 36"(30"H) : 101 lbs/ 44"(30"H) : 126 lbs

Electrical Requirements:  
 600 CFM models draw approx. 2.7 Amps  
 1200 CFM models draw approx. 5.4 Amps

Hood Sone Level:  
 Ranges from 5-7

CORNUFÉ SERIES DETAILS & ACCESSORIES

CLASSIC COLORS

- N Matte Black
- M Gloss Black
- I Stainless Steel
- W Pure White
- L Provence Blue

TRIM OPTIONS

Trim	Accents	Rails
N Stainless Steel	Satin Chrome	Stainless Steel
F Stainless Steel	Polished Brass	Polished Brass
P Stainless Steel	Polished Chrome	Polished Stainless Steel

**Note:** The Polished Brass Trim is natural, non coated metal and will patina over time.

ÉTOILE COLORS

- P Morning Dew
- G Graphite
- O Ocean
- H Wintersky

ACCESSORIES (AVAILABLE FOR 110 AND 90):

Part Number	Description
CFEBPLATE	French Plaque for CornuFé 110 Dual Fuel Ranges
CFEBPLATE90	French Plaque for CornuFé 90 Dual Fuel Ranges
CFEGRIDDLE	Grill/Griddle Plate for all CornuFé Dual Fuel Ranges
P050553	Wok Adapter for all CornuFé Dual Fuel Ranges
A037977	High Altitude Kit - Natural Gas for all CornuFé Dual Fuel Ranges
A037982	High Altitude Kit - Propane for all CornuFé Dual Fuel Ranges
O9KIRSIR01	Recirculating kit for CornuFe Hood
P030292	CornuFé 110 Extra Flat Rack
CFDF5BB	CornuFé Dual Fuel set of 5 Brass Burners

SUZANNE KASLER COLORS

- A Tapestry
- Q Roquefort

Please confirm inventory status at time of order.