

**BS 470/471 611**

**BS 474/475 611**

**BS 484/485 611**

Combi-steam oven

---

## Table of Contents

---

---

<b>▲ Safety Definitions</b>	<b>3</b>
<hr/>	
<b>IMPORTANT SAFETY INSTRUCTIONS</b>	<b>4</b>
Proper Installation and Maintenance	4
Fire Safety	4
Burn Prevention	5
Child Safety	6
Cleaning Safety	6
Cookware Safety	7
Proposition 65 Warning	7
<hr/>	
<b>Causes of Damage</b>	<b>8</b>
<hr/>	
<b>Environmental protection</b>	<b>8</b>
Saving energy	8
<hr/>	
<b>Getting to know the appliance</b>	<b>9</b>
Combi-steam oven	9
Displays and controls	10
Symbols	10
Colors and display	11
Automatic door opening	11
Additional information <b>i</b> and <b>i</b> <sup>®</sup>	11
Cooling fan	11
Program selection positions	12
Accessories	13
Special accessories	14
<hr/>	
<b>Before first use</b>	<b>14</b>
Setting the language	14
Setting the time format	15
Setting the time	15
Setting the date format	15
Setting the date	15
Setting the temperature unit	15
Setting the water filter	15
Setting water hardness	16
Completing initial set-up	16
Calibrating	16
Cleaning the door panel	17
Cleaning accessories	17
<hr/>	
<b>Water filter</b>	<b>17</b>
Operation with or without water filter	17
Change water filter	17
<hr/>	
<b>Activating the appliance</b>	<b>18</b>
Standby	18
Activate appliance	18

---

<b>Operating the appliance</b>	<b>18</b>
Oven interior	18
Inserting accessories	19
Turning on	19
Misting	19
Steam removal	19
After every use	20
Safety shut-off	20
<hr/>	
<b>Timer functions</b>	<b>20</b>
Launching the timer menu	20
Timer	20
Stopwatch	21
Cooking time	21
End of cooking time	22
<hr/>	
<b>Sabbath mode</b>	<b>23</b>
Sabbath mode	23
Yom Tov mode	24
<hr/>	
<b>Personal recipes</b>	<b>25</b>
Recording a recipe	25
Programming a recipe	25
Entering a name	26
Starting a recipe	26
Change recipe	26
Deleting a recipe	26
<hr/>	
<b>Core temperature probe</b>	<b>27</b>
Stick the core temperature probe into the food	27
Setting the core temperature	27
Core temperature guidelines	28
<hr/>	
<b>Childproof lock</b>	<b>29</b>
Activating the child lock	29
Deactivating the child lock	29
<hr/>	
<b>Factory setting</b>	<b>30</b>
<hr/>	
<b>Cleaning and maintenance</b>	<b>32</b>
Cleaning agents	32
Cleaning program	33
Drying program	35
Descaling program	36
<hr/>	
<b>Troubleshooting</b>	<b>38</b>
Power cut	39
Demo mode	39
Replacing the oven interior lamp	39
<hr/>	
<b>Customer service</b>	<b>40</b>

<b>Tables and tips</b>	<b>41</b>
Vegetables	41
Fish	42
Fish – low-temperature steaming	43
Meat – cooking at higher temperatures	44
Meat/poultry – low-temperature cooking	45
Poultry	46
Sous-vide cooking	47
Grilling	50
Side dishes	51
Desserts	51
Other	52
Baked goods	52
Dough proving (leaving to rise)	54
Refreshing (warming up)	54
Defrosting	55
Preserving	55
Extracting juice (soft fruits)	56
Preparing yoghurt	56
Preparing bulky food	57
Acrylamide in foodstuffs	57

---

## Safety Definitions

---



---

### **WARNING**

This indicates that death or serious injuries may occur as a result of non-observance of this warning.

---



---

### **CAUTION**

This indicates that minor or moderate injuries may occur as a result of non-observance of this warning.

---

**NOTICE:** This indicates that damage to the appliance or property may occur as a result of non-compliance with this advisory.

**Note:** This alerts you to important information and/or tips.

Additional information on products, accessories, replacement parts and services can be found at [www.gaggenau.com](http://www.gaggenau.com) and in the online shop [www.gaggenau.com/zz/store](http://www.gaggenau.com/zz/store)



# IMPORTANT SAFETY INSTRUCTIONS

READ AND SAVE THESE INSTRUCTIONS

## IMPORTANT SAFEGUARDS

## SAVE THESE INSTRUCTIONS.

---

### WARNING

When properly cared for, your new appliance has been designed to be safe and reliable. Read all instructions carefully before use. These precautions will reduce the risk of burns, electric shock, fire, and injury to persons. When using kitchen appliances, basic safety precautions must be followed, including those in the following pages.

---

## Proper Installation and Maintenance

Have the installer show you the location of the circuit breaker or fuse. Mark it for easy reference.

This appliance must be properly installed and grounded by a qualified technician. Connect only to properly grounded outlet. Refer to Installation Instructions for details.

This appliance is intended for normal family household use only. It is not approved for outdoor use. See the Statement of Limited Product Warranty. If you have any questions, contact the manufacturer.

Do not store or use corrosive chemicals, vapors, flammables or nonfood products in or near this appliance. It is specifically designed for use when heating or cooking food. The use of corrosive chemicals in heating or cleaning will damage the appliance and could result in injury.

Do not operate this appliance if it is not working properly, or if it has been damaged. Contact an authorized servicer.

Do not obstruct oven vents.

Do not repair or replace any part of the appliance unless specifically recommended in this manual. Refer all servicing to an authorized servicer.

---

### WARNING

#### Risk of burns

To avoid risk of injury, turn off the interior light before cleaning the oven to allow the bulbs to cool down. The bulbs can become very hot when switched on. Keep the light off while cleaning the oven.

---

---

### WARNING

Make sure the appliance and lights are cool and power to the appliance has been turned off before replacing the light bulb(s). Failure to do so could result in electrical shock or burns. The lenses (if equipped) must be in place when using the appliance. The lenses (if equipped) serve to protect the light bulb from breaking. The lenses (if equipped) are made of glass. Handle carefully to avoid breaking. Broken glass can cause an injury.

---

---

### WARNING

Light socket is live when door is open if main power supply is not turned off.

---

---

### WARNING

Risk of short circuiting! Never allow electrical appliance cords to become pinched in the hot appliance door. The cord's insulation can melt.

---

## Fire Safety

---

### WARNING

NEVER cover any slots, holes or passages in the oven bottom or cover an entire rack with materials such as aluminum foil. Doing so blocks air flow through the oven. Aluminum foil linings may also trap heat, causing a fire hazard.

---

If materials inside an oven or warming drawer should ignite, keep door closed. Turn off the appliance and disconnect the circuit at the circuit breaker box.

# IMPORTANT SAFETY INSTRUCTIONS

## READ AND SAVE THESE INSTRUCTIONS

---

### WARNING

---

Use this appliance only for its intended use as described in this manual. NEVER use this appliance as a space heater to heat or warm the room. Doing so may result in overheating the appliance. Never use the appliance for storage.

---

Always have a working smoke detector near the kitchen.

In the event that personal clothing or hair catches fire, drop and roll immediately to extinguish flames.

Have an appropriate fire extinguisher available, nearby, highly visible and easily accessible near the appliance.

Smother flames from food fires other than grease fires with baking soda. Never use water on cooking fires.

---

### WARNING

---

TO REDUCE THE RISK OF INJURY TO PERSONS IN THE EVENT OF A GREASE FIRE, OBSERVE THE FOLLOWING:

- a) SMOTHER FLAMES with a close-fitting lid, cookie sheet, or metal tray, then turn off the burner. BE CAREFUL TO PREVENT BURNS. If the flames do not go out immediately, EVACUATE AND CALL THE FIRE DEPARTMENT.
  - b) NEVER PICK UP A FLAMING PAN – You may be burned.
  - c) DO NOT USE WATER, including wet dishcloths or towels – a violent steam explosion will result.
  - d) Use an extinguisher ONLY if:
    - You know you have a Class ABC extinguisher, and you already know how to operate it.
    - The fire is small and contained in the area where it started.
    - The fire department is being called.
    - You can fight the fire with your back to an exit.
- 

## Burn Prevention

DO NOT TOUCH HEATING ELEMENTS OR INTERIOR SURFACES OF OVEN - Heating elements may be hot even though they are dark in color. Interior surfaces of an oven become hot enough to cause burns. During and after use, do not touch, or let clothing, potholders, or other flammable materials contact heating elements or interior surfaces of oven until they have had sufficient time to cool. Other surfaces of the appliance may become hot enough to cause burns. Among these

surfaces are oven vent openings, surfaces near these openings and oven doors.

Exercise caution when opening the appliance. Standing to the side, open the door (or drawer) slowly and slightly to let hot air and/or steam escape. Keep your face clear of the opening and make sure there are no children or pets near the unit. After the release of hot air and/or steam, proceed with your cooking. Keep doors shut unless necessary for cooking or cleaning purposes. Do not leave open doors unattended.

Do not heat or warm unopened food containers. Build-up of pressure may cause the container to burst and cause injury.

Always place oven racks in desired location while oven is cool. Always use oven mitts, when the oven is warm. If a rack must be moved while oven is hot, do not let potholder contact the heating elements.

---

### CAUTION

---

To avoid possible injury or damage to the appliance, ensure rack is installed exactly per installation instructions and not backwards or upside down.

---

Always use dry potholders. Moist or damp potholders on hot surfaces may result in burns from steam. Do not let potholder touch hot heating elements. Do not use a towel or other bulky cloth.

---

### WARNING

---

#### Scalding hazard

Movement when opening the appliance door and when removing the cookware can cause hot liquid to spray out. Do not stand too close to the appliance when opening it. Open appliance door carefully. Remove cookware carefully. Keep children away.

---

Secure all loose garments, etc. before beginning. Tie long hair so that it does not hang loose, and do not wear loose fitting clothing or hanging garments, such as ties, scarves, jewelry, or dangling sleeves.

Use caution when cooking foods with high alcohol content (e.g. rum, brandy, bourbon) in the oven. Alcohol evaporates at high temperatures. There is a risk of burning as the alcohol vapors may catch fire in the oven. Use only small quantities of alcohol in foods, and open the oven door carefully.



# IMPORTANT SAFETY INSTRUCTIONS

READ AND SAVE THESE INSTRUCTIONS

---

## WARNING

---

### Risk of scalding

Hot liquid may spill over the sides of cooking accessories when they are removed from the oven cavity. Carefully remove cooking accessories with oven mitts.

---

---

## WARNING

---

### Risk of scalding

Hot steam can escape when you open the appliance door. Steam is not visible at certain temperatures. Do not stand too close to the appliance when opening it. Open the appliance door with caution. Keep children away.

---

---

## WARNING

---

### Risk of burns

Hot steam can leak during operation. Do not touch the ventilation openings. Keep children away.

---

## Child Safety

When children become old enough to use the appliance, it is the responsibility of the parents or legal guardians to ensure that they are instructed in safe practices by qualified persons.

Do not allow anyone to climb, stand, lean, sit, or hang on any part of an appliance, especially a door, warming drawer, or storage drawer. This can damage the appliance, and the unit may tip over, potentially causing severe injury.

Do not allow children to use this appliance unless closely supervised by an adult. Children and pets should not be left alone or unattended in the area where the appliance is in use. They should never be allowed to play in its vicinity, whether or not the appliance is in use.

---

## CAUTION

---

Items of interest to children should not be stored in an appliance, in cabinets above an appliance or on the backsplash. Children climbing on an appliance to reach items could be seriously injured.

---

## Cleaning Safety

Risk of severe burns! Do not clean the appliance immediately after turning it off. The water in the evaporator dish is still hot. Wait until the appliance has cooled down.

Keep oven free from grease build up.

---

---

## WARNING

---

### Risk of injury

Scratched glass in the appliance door can burst. Do not use any glass scrapers or strong or abrasive cleaning agents.

---

---

## WARNING

---

### Risk of electrical shock

Moisture entering the appliance can cause an electrical shock. Don't use a high-pressure cleaner or steam cleaner.

---

---

## CAUTION

---

Do not remove the wax plugs from the opening of the cleaning cartridge. Do not use any other detergents. Do not use damaged cartridges.

Never heat the appliance up if a cartridge has been inserted.

---

---

## WARNING

---

To prevent the cleaner from coming into contact with the skin or eyes, do not remove the locking cap from a spent cartridge.

---

# **IMPORTANT SAFETY INSTRUCTIONS**

READ AND SAVE THESE INSTRUCTIONS

## **Cookware Safety**

Do not place food directly on oven bottom.

Follow the manufacturer's directions when using cooking or roasting bags.

---

### **WARNING**

---

#### **Risk of electric shock**

Use of a wrong core temperature probe can damage the insulation. Use only the core temperature probe intended for this appliance.

---

Ovenware must be heat and steam resistant. Silicone baking pans are not suitable for Combination mode.

When using Steam mode with a perforated cooking pan, always slide the baking pan underneath it. The pan will catch any drippings.

The oven bottom and the evaporator dish must always remain clear. Always place ovenware on the rack or in the perforated cooking pan.

## **Proposition 65 Warning:**

This product may contain a chemical known to the State of California, which can cause cancer or reproductive harm. Therefore, the packaging of your product may bear the following label as required by California:

**STATE OF CALIFORNIA PROPOSITION 65 WARNING:**



Cancer and Reproductive Harm - [www.P65Warnings.ca.gov](http://www.P65Warnings.ca.gov)

---

## Causes of Damage

---

### NOTICES:

- Do not place anything directly on the oven floor. Do not line it with aluminum foil. Heat build-up can damage the appliance.
- The oven bottom should always remain clear. Always place dishes in a perforated baking pan or on a rack.
- We recommend you install a descaling system for hard mains water. You can inquire with your waterworks to obtain information about your mains water.
- Aluminum foil may not contact the door pane in the oven. This can cause permanent discoloration of the door pane.
- Dishes must be heat and steam resistant. Silicone baking dishes are not suited for combination operation with steam.
- Use only original accessories in the oven interior. Rusting material (such as serving platters or knives and forks) can cause corrosion in the oven interior.
- Use original small parts (e.g. knurled nuts) only. Reorder small parts through out spare parts service if these should be lost..
- Do not leave moist groceries in a closed oven for an extended period of time. It can lead to corrosion inside the oven.
- Salt, spicy sauces (e.g. ketchup or mustard) or salted dishes (e.g. cured roast) contain chlorides and acids. These corrode the surfaces of stainless steel. Always remove residues immediately.
- Fruit juice can leave stains in the oven. Always remove fruit juice immediately when safe to touch, and wipe up first with a damp and then a dry cloth.
- Your appliance's oven interior consists of high-grade stainless steel. Corrosion can occur in the oven interior if it is not cared for properly. Observe the care and cleaning notes in the operating instructions. After every use, clean the oven interior straight after the appliance has cooled down. After cleaning, dry the oven interior with the drying program.
- Do not detach the door seal. The appliance door will no longer close properly if the door seal is damaged. Adjoining furniture frontages may be damaged. Have the door seal replaced.

---

## Environmental protection

---

Unpack the appliance and dispose of the packaging in an environmentally friendly manner.

### Saving energy

- Open the appliance door as little as possible while cooking.
- Use dark, black-painted or enamelled baking forms. These absorb the heat particularly well.
- It is best to bake several cakes in succession. The steam oven is still warm. This shortens the baking time for the second cake. You can also slide in two loaf tins next to each other.
- For longer cooking times, you can switch off the steam oven 10 minutes before the end of the cooking time and you can use the residual heat to finish cooking.
- When steaming, you can cook simultaneously on several levels. If dishes require different cooking times, insert the dishes that require the longest time first.



---

## Getting to know the appliance

---

You will get to know your new appliance here. We explain the control panel and the individual controls to

you. You are informed about the oven interior and accessories.

### Combi-steam oven

These instructions apply to different versions of the appliance. Slight deviations are possible depending on the appliance type.

Operation is identical for all appliance versions.

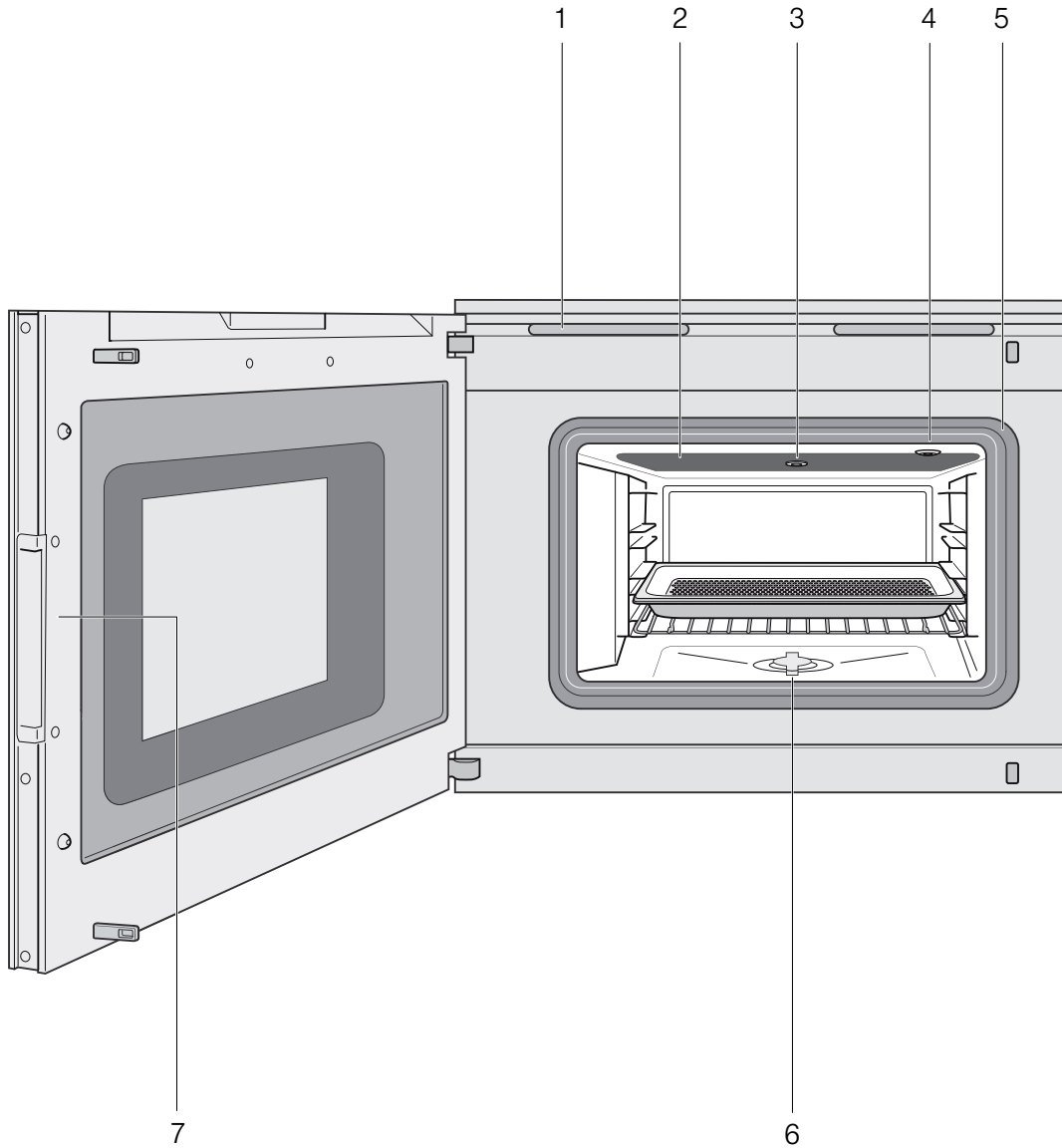

---

1	Ventilation slots
2	Broil element behind glass ceramic
3	Socket for cleaning or descaling cartridge
4	Socket for core temperature sensor
5	Door seal

---

---

6	Drainage sieve
7	Recessed handle

---

Do not obstruct oven vents.

**NOTICE:** Do not place food directly on oven bottom.

## Displays and controls

These instructions apply to different versions of the appliance. Slight deviations are possible depending on the appliance type.

Operation is identical for all appliance versions.

### Operator control on the appliance top

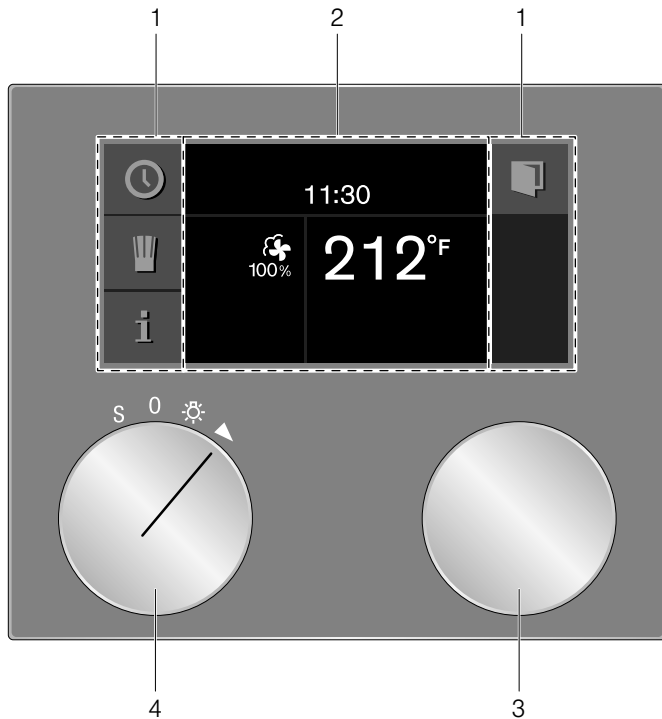

### Operator control on the appliance bottom

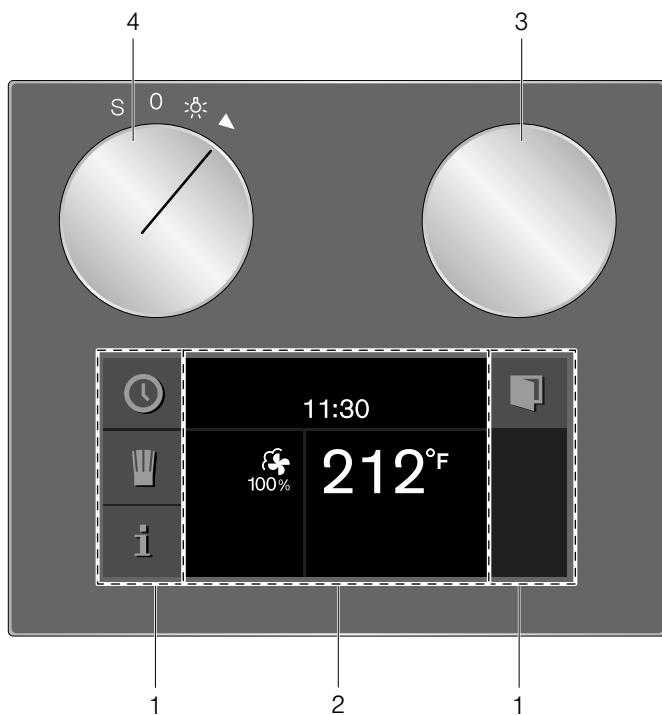

1	Control panel	These areas are touch-sensitive. Touch a symbol to select the applicable function.
2	Display	The display shows current settings and options, for example.
3	Rotary selector	With the rotary selector you can select the temperature and make other settings.
4	Function selector	The function selector is used to select the type of heating, the cleaning function or the basic settings.

## Symbols

Symbol	Function
▶	Start
■	Stop
	Pause/end
X	Cancel
C	Delete
✓	Confirm/save settings
>	Selection arrow
🚪	Open appliance door
i	Launching additional information
⤴	Preheating with status display
🗑️	Launching personal recipes
rec ●	Recording a menu
🔧	Edit settings
>A <sup>A</sup>	Enter a name
⏪ x	Delete letters
🔒	Child lock
🕒	Launching the timer menu
🕒	Launching the Sabbath mode
🔪	Demo mode
🔪	Core temperature probe
💧	Misting
👉	Starting steam removal
👎	Stopping steam removal

## Colors and display

### Colors

The various colors serve to guide you in the various adjustment situations.

Orange	First settings Main functions
Blue	Basic settings Cleaning
White	Adjustable values

### Presentation

The presentation of symbols, values or the entire display changes depending on the situation.

Zoom	The display of the setting you are just changing is enlarged. Just before it elapses, a duration that is just elapsing is enlarged (e.g. the last 60 seconds in the case of timers).
Minimized display screen	After a short time, the display screen is minimized and only the most important things are displayed. This function is the default and can be modified in the basic settings.

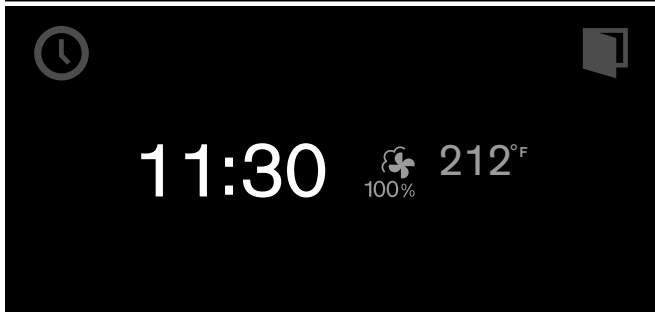

## Automatic door opening

When you touch the  symbol, the appliance door springs open and you can open it fully with the handle recess at the side.

Automatic door opening does not work when the child lock is activated or in the event of a power failure. You can open the door manually with the handle recess at the side.

## Additional information **i** and **i**<sup>Ⓢ</sup>

By touching the **i** symbol, you can call up additional information. For example, information on the heating function set or on the current temperature of the cooking compartment.

**Note:** During continuous operation, small fluctuations in temperature are normal after the oven has heated up.

The **i**<sup>Ⓢ</sup> symbol is displayed for important information and action prompts. Important information on safety and operation mode are occasionally shown automatically. These messages either disappear automatically after a few seconds or must be confirmed with .

## Cooling fan

Your appliance has a cooling fan. The cooling fan switches on during operation. Depending on the appliance version, the warm air escapes above or under the door.







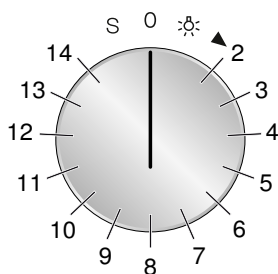

After removing cooked food, keep the door closed until the appliance cools down. The appliance door must not be left ajar, as adjoining kitchen furniture may be damaged. The cooling fan continues to run for a while and then switches off automatically.











### CAUTION

Do not cover up the ventilation slots. Otherwise, the appliance will become overheated.

## Program selection positions



Position	Function/type of heating	Temperature	Use
0	Off position		
☀	Light		
2	 Hot air + 100% humidity	85 - 450° F (30 - 230°C) Default temperature 212° F (100 °C)	Steaming at 160 - 212°F (70°C - 100°C): For vegetables, fish and side dishes. The food is completely surrounded by steam Combination mode at 250 - 450° F (120 - 230°C): For puff pastry, bread and rolls. Hot air and steam are combined.
3	 Hot air + 80% humidity	85 - 450° F (30 - 230°C) Default temperature 340° F (170 °C)	Combination mode: For puff pastry, meat and poultry. Hot air and steam are combined.
4	 Hot air + 60% humidity	85 - 450° F (30 - 230°C) Default temperature 340° F (170 °C)	Combination mode: For yeast-risen dough and bread. Hot air and steam are combined. Letting dough rise: For yeast dough and sourdough. Dough will rise considerably more quickly than at room temperature. Hot air and steam are combined so that the surface of the dough does not dry out. The optimal temperature setting for yeast dough is 100°F (38°C).
5	 Hot air + 30% humidity	85 - 450° F (30 - 230°C) Default temperature 340° F (170 °C)	Cooking without added liquid: For pastries With this setting, no steam is generated and the ventilation flap is closed. Any steam escaping from the food therefore remains in the cooking compartment and prevents the food from drying out.
6	 Hot air and 0% humidity*	85 - 450° F (30 - 230°C) Default temperature 340° F (170 °C)	Hot air: For cakes, biscuits and bakes. The fan in the back panel of the oven distributes the heat evenly throughout the cooking compartment.
7	 Low-temperature cooking	85 - 200° F (30 - 90°C) Default temperature 160° F (70°C)	Low-temperature cooking for meat. Gentle slow cooking for a particularly tender result.
8	 Sous-vide cooking	125 - 200° F (50 - 95°C) Default temperature 140° F (60°C)	Cooking "under a vacuum" at low temperatures between 125 - 200° F (50 - 95°C) and in 100% steam: suitable for meat, fish, vegetables and dessert. A vacuum-packing machine is used to heat-seal the food in a special air-tight, heat-resistant cooking bag. The protective envelope retains the nutrients and flavors.
9	 Full surface grill + circulated air	85 - 450° F (30 - 230°C) Default temperature 445° F (230 °C)	For vegetable skewers and prawn skewers.

Position	Function/type of heating	Temperature	Use
10	 Full surface grill	85 - 450° F (30 - 230 °C) Default temperature 445° F (230 °C)	For grilled vegetables, browning (e.g. cakes with meringue) and toast with topping.
11	 Full surface grill level 1 + humidity	85 - 450° F (30 - 230 °C) Default temperature 340° F (170 °C)	Grill mode with humidity: For bakes and gratins.
12	 Full surface grill level 2 + humidity	85 - 450° F (30 - 230 °C) Default temperature 340° F (170 °C)	Grill mode with humidity: For stuffed vegetables. The grill output is increased.
13	 Defrosting	100 - 140° F (40 - 60 °C) Default temperature 115° F (45 °C)	For vegetables, meat, fish and fruit. The moisture gently transfers the heat to the food. The food does not dry out or lose its shape.
14	 Reheating	140 - 360° F (60 - 180 °C) Default temperature 250° F (120 °C)	For cooked food and baked goods. Cooked food is gently reheated. The steam ensures that the food does not dry out. Reheat plated meals at 250° F (120 °C) and baked goods at 360° F (180 °C).
S	 Basic settings		Your appliance can be individually adjusted in the basic settings.
	 Cleaning program		The cleaning program can be used to remove stubborn dirt from the cooking compartment.
	 Drying program		The drying program dries the cooking compartment after steaming or cleaning.
	 Descaling program		The descaling program can be used to remove lime scale from the cooking compartment.
	 Water filter change		Change the water filter if a descaling system is installed.
	 Delete the descaling notice		Delete the message on the display after descaling.

## Accessories

Use only the accessories included or obtainable from after-sales service. It has been specially adapted to your appliance. Make sure you always insert accessories into the interior the right way round.

Your appliance comes with the following accessories:



### Rack

for cookware, cake pans and casseroles and for roasts

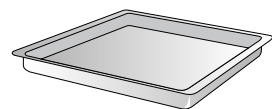

### Stainless steel cooking receptacle, unperforated, GN 2/3, 40 mm deep

for cooking rice, pulses and cereals, for baking cake baked on trays and for collecting dripping liquid during steaming

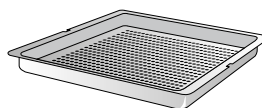

**Stainless steel cooking receptacle, GN 2/3, 40 mm deep** for steaming vegetables or fish, for extracting berry juices and for thawing

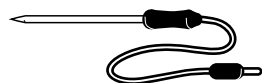

**Core temperature probe** for precise preparation of meat, fish, poultry and bread

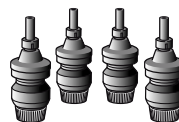

**Set with 4 cleaning cartridges**

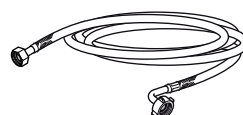

**Water inlet hose, 3 m**

**Water outlet hose, 3 m**

## Special accessories

You can order the following accessories from your specialist dealer:

CL S10 040	Set with 4 cleaning cartridges
CL S20 040	Set with 4 descaling cartridges
GN 114 130	Stainless steel cooking insert GN 1/3, unperforated, 1½" (40 mm) deep, 1.5 l
GN 114 230	Stainless steel cooking insert GN 2/3, unperforated, 1½" (40 mm) deep, 3 l
GN 124 130	Stainless steel cooking insert GN 1/3, perforated, 1½" (40 mm) deep, 1.5 l
GN 124 230	Stainless steel cooking insert GN 2/3, perforated, 1½" (40 mm) deep, 3 l
GN 144 130	GN 1/3 cooking insert, non-stick, unperforated, depth: 40 mm, 1.5 l
GN 144 230	GN 2/3 cooking insert, non-stick, unperforated, depth: 40 mm, 3 l
GN 154 130	GN 1/3 cooking insert, non-stick, perforated, depth: 40 mm, 1.5 l
GN 154 230	GN 2/3 cooking insert, non-stick, perforated, depth: 40 mm, 3 l
GN 340 230	Cast aluminum roaster GN 2/3, 6½" (165 mm) high, non-stick
GN 410 130	Stainless steel cover GN 1/3
GN 410 230	Stainless steel cover GN 2/3
GR 220 046	Wire rack, chrome-plated, with feet

Use the accessories only as indicated. The manufacturer assumes no liability for incorrect usage of the accessories.

---

## Before first use

---

In this chapter, you can find out what you must do before using your oven to prepare food for the first time. Read the "Safety information" chapter beforehand.

The appliance must be completely installed and connected.

The "First settings" menu appears in the display after the mains has been connected. You can now set your new appliance:

- Language
- Time format
- Time
- Date format
- Date
- Temperature format
- Water hardness

### Notes

- The "Initial settings" menu only appears when you first connect the power or if the appliance has been without power for several days. After connecting the power, first the GAGGENAU logo appears for approx. 30 seconds, then the "Initial settings" menu appears automatically.
- You can change these settings at any time (see the "Basic settings" chapter).

## Setting the language

The default language appears in the display.

- 1 Select the desired display language with the rotary selector.
- 2 Confirm with ✓.

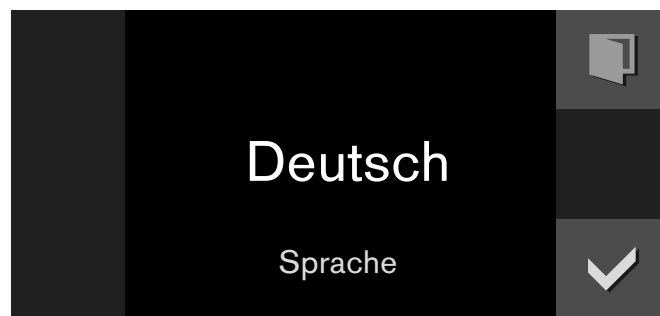

**Note:** When the language is changed, the system is restarted; this procedure takes a few seconds.

## Setting the time format

the two possible formats 24h and AM/PM appear in the display. The default format is 24h.

- 1 Set the required format with the rotary selector.
- 2 Confirm with ✓.

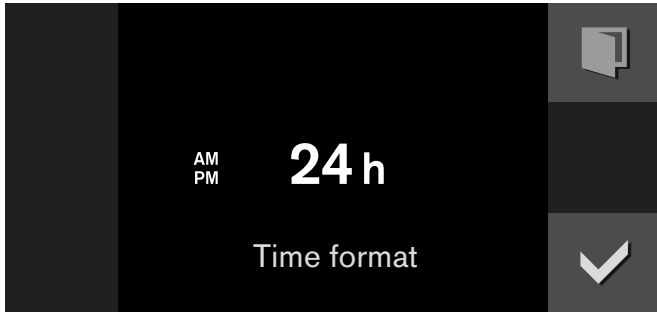

## Setting the time

The time appears in the display.

- 1 Set the required time with the rotary selector.
- 2 Confirm with ✓.

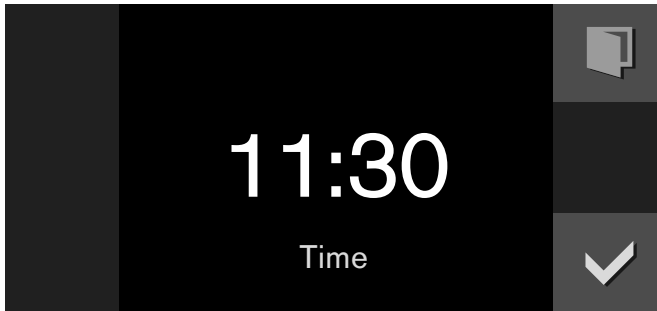

## Setting the date format

The three possible formats D.M.Y, D/M/Y and M/D/Y appear in the display. The D.M.Y is the default.

- 1 Set the required format with the rotary selector.
- 2 Confirm with ✓.

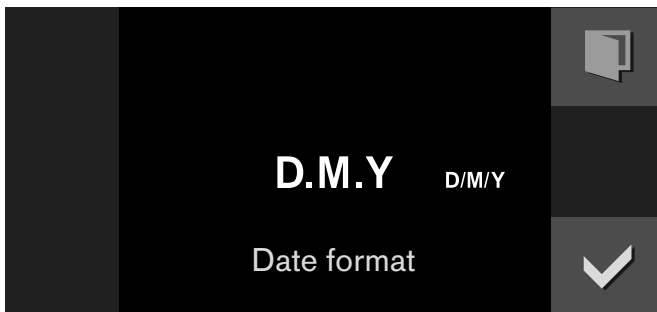

## Setting the date

The default date appears in the display. The day setting is already active.

- 1 Set the required day with the rotary selector.
- 2 Switch to the month setting with the > symbol.
- 3 Set the month with the rotary selector.
- 4 Switch to the year setting with the > symbol.
- 5 Set the year with the rotary selector.
- 6 Confirm with ✓.

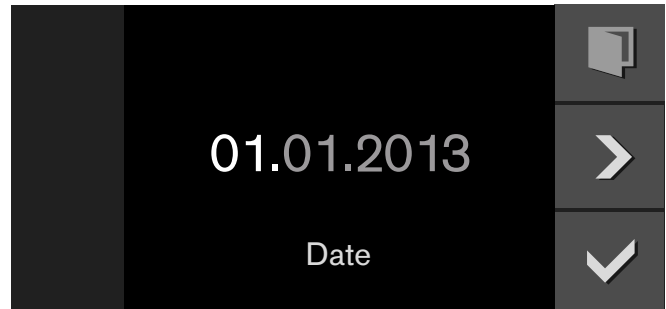

## Setting the temperature unit

The two possible units °C and °F will appear on the display. The default unit is °C.

- 1 Use the rotary selector to select the unit you require.
- 2 Press ✓ to confirm.

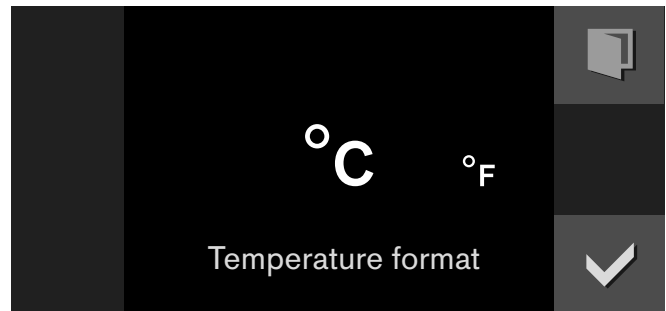

## Setting the water filter

"Water filter" appears in the display. The default is "Available".

It is recommended to install the descaling system GF 111 100 if the water hardness exceeds 7° dH (carbonate hardness 5° dH).

- 1 Use the rotary selector to select "Available" (with water filter) or "Not available" (without water filter).
- 2 Confirm with ✓.
- 3 If water filter "Available" has been selected: "Water filter capacity" is shown in the display.

- 4 Turn the rotary selector to select the capacity of the filter cartridge (between 100 - 9000 liters). Refer to the instructions included with the filter cartridge.
- 5 Confirm with ✓.

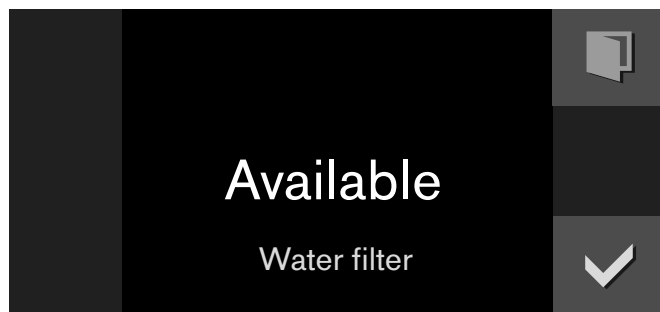

## Setting water hardness

"Water hardness" appears in the display.

- 1 Check the mains water with the included carbonate hardness test: fill the small measurement tube with mains water up to the 5 ml mark.
- 2 Add drops of indicator solution until the color changes from purple to yellow.  
**Important:** count the drops and carefully swing the measurement tube after every drop until the liquids have mixed thoroughly. The number of drops corresponds to the water hardness.
- 3 Set the measured water hardness with the rotary selector. The value 12 is set by default.
- 4 Confirm with ✓.

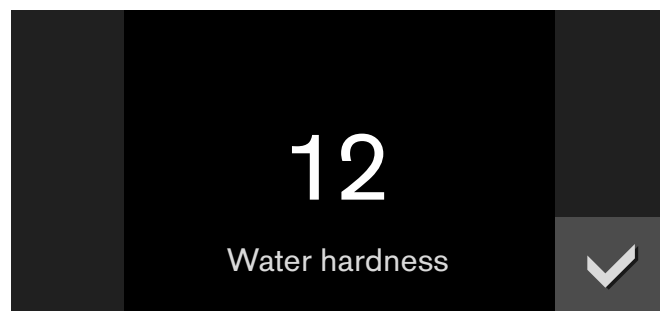

## Completing initial set-up

"Initial set-up complete. Please calibrate the appliance before first cooking" appears in the display.

Confirm with ✓.

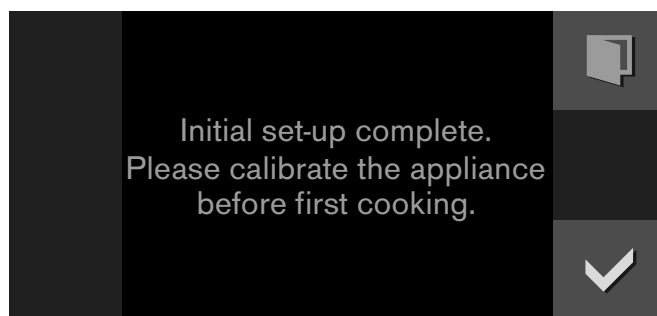

The appliance enters the standby mode and the standby display appears. The appliance is now ready for operation.

Calibrate the appliance before steaming for the first time. The appliance sets the boiling point.

## Calibrating

The boiling point of water depends on barometric pressure. As air pressure drops with increasing elevation, the boiling point drops as well. During calibration, the appliance sets the boiling point to the pressure conditions at the place where it is installed.

It is important for the appliance to steam for 20 minutes at 212° F (100°C) without interruption. Do not open the appliance door during this time.

### Notes

- Calibrate the appliance only when it is cold.
- During calibration, the appliance generates more steam than it normally would do.

- 1 Set the function selector to **S**.
- 2 Select "Basic settings" using the rotary selector.
- 3 Touch the ✓ symbol.
- 4 Select "Calibration" using the rotary selector.
- 5 Touch the \\_ symbol.
- 6 Remove all accessories from the oven interior and touch the ✓ symbol.
- 7 The duration of 20:00 minutes appears. Touch ▶ to start calibration.

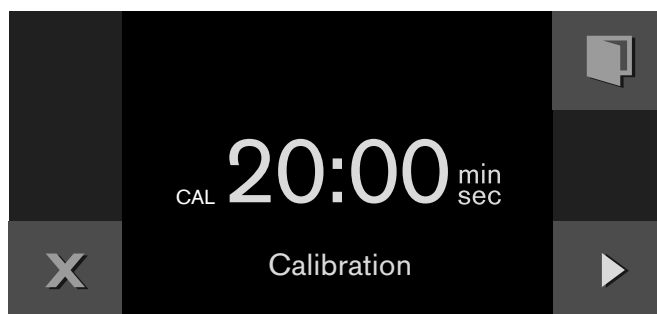



Calibration begins. The elapsing time is shown on the display.

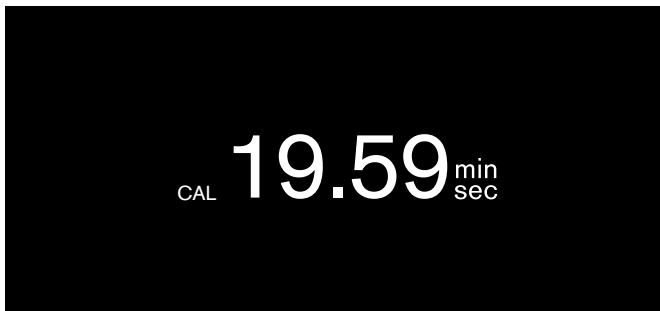

**Note:** Do not interrupt calibration. Do not turn the function selector. Do not open the appliance door.

A message appears in the display once calibration has ended. Touch ✓ to confirm and turn the function selector to 0.

#### **After a removal**

Repeat calibration so that the appliance will automatically adapt again to the new location.

#### **After resetting to factory settings**

After resetting to factory settings in the basic settings menu the appliance has to be recalibrated.

#### **After a power failure**

The appliance saves the calibration settings, even after a power failure or a disconnection from the mains. It need not be recalibrated.

## **Cleaning the door panel**

The door seal has been greased in the factory to make it leaktight. There may be traces of grease left on the door panel.

Clean the door panel with glass cleaner and a window cloth or microfibre cloth before using the appliance for the first time. Do not use glass scrapers.

## **Cleaning accessories**

Before using accessories for the first time, thoroughly clean them with hot soapy water and a soft dish cloth.

---

## **Water filter**

---

### **Operation with or without water filter**

You can use the appliance with or without a water filter.

It is recommended to install the descaling system GF 111 700 if the water hardness exceeds 7°dH (carbonate hardness 5°dH).

### **Change water filter**

Filter cartridges should be replaced regularly. Replacement cartridges are available from after-sales service or in the online shop (order number GF 121 710).

The capacity of the filter cartridge depends on the frequency of use of the appliance and your regional water hardness. A message will appear in the display to remind you when the filter needs to be replaced. Regardless of the actual amount of water filtered the filter cartridge needs to be changed after 12 months at the latest.

- 1 Set the function selector to **S**. Select "Water filter change" using the rotary selector.
- 2 The ☉ symbol is displayed. Confirm with ✓.
- 3 Change the water filter. Refer to the instructions included with the filter cartridge. Confirm with ✓.
- 4 "Select water filter capacity" is shown in the display. Confirm with ✓.
- 5 Turn the rotary selector to select the capacity of the filter cartridge (between 100 - 9000 liters). Confirm with ✓.

The water filter change is complete. Touch the ✓ symbol. The appliance is now ready for operation.

---

## Activating the appliance

---

### Standby

The appliance is in the standby mode when no function is set or the child lock is activated.

The control panel's brightness is reduced in the standby mode.

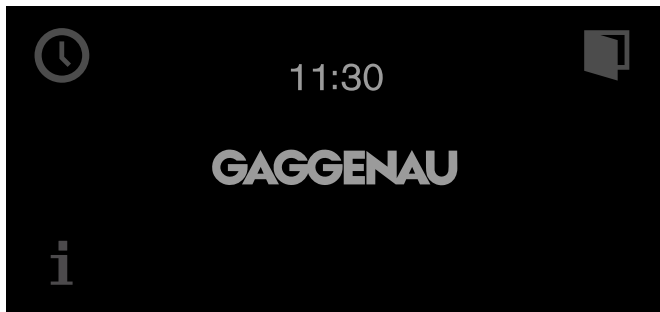

#### Notes

- There are various displays for the standby mode. The GAGGENAU logo and the time are set by default. Refer to the section entitled **Factory setting** if you would like to change the display.
- The display's brightness depends on the vertical viewing angle. You can adjust the display by way of the "Brightness" setting in the factory settings.

### Activate appliance

In order to exit standby mode, you can either

- Set the function selector,
- Touch a control panel,
- or open or close the door.

Now you can set the desired function. Read the appropriate chapters to learn how to set functions.

#### Notes

- If "Standby screen = off" is selected in the factory setting, you must turn the function selector to exit the standby mode.
- The standby display appears again if you have not made any settings for a long while after activation.
- The cooking compartment lighting goes out after a little while if the door is open.

---

## Operating the appliance

---

### Oven interior

The cooking compartment has four shelf positions. The shelf positions are counted from the bottom up.

**Note:** When steaming, defrosting, dough proofing and refreshing, you can use up to three insertion levels at the same time (levels 2, 3 and 4). You can only bake on one level, use level 2 when baking (or level 1 for higher cake tins).

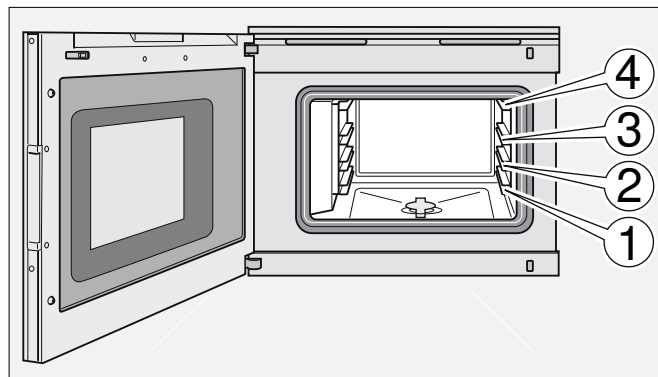

---

#### ⚠ CAUTION

Do not place anything on the cooking compartment floor. Do not cover it with aluminium foil. A build-up of heat could damage the appliance or cause injury.

---

---

#### ⚠ CAUTION

The cooking compartment floor must always be kept clear. Always place ovenware in a perforated cooking container or on a wire rack.

---

---

#### ⚠ CAUTION

Do not slide any accessories between the shelf positions, or they may tip.

---

## Inserting accessories

The rack and the perforated cooking receptacle feature a latching function. The latching function prevents tilting of accessories when pulling them out. You must insert accessories in the cooking interior correctly so that tilt protection will work. When removing accessories, you must raise them slightly.

When inserting the rack, make sure

- that the engaging lug (a) points upward
- that the rack's safety clip is at the rear and top.

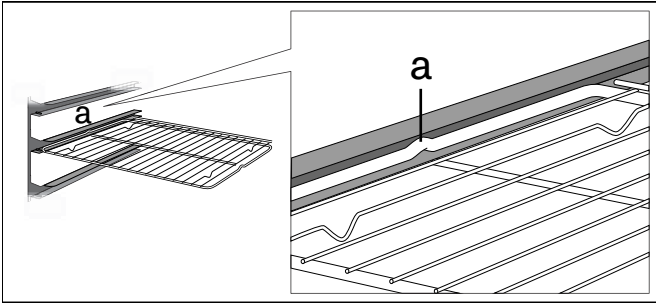

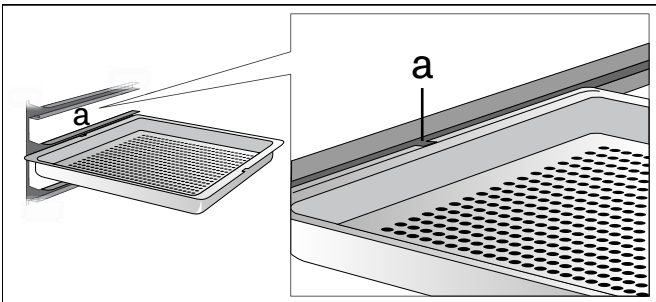

When pushing in the perforated cooking receptacle, make sure that the recess (a) points to the side.



## Turning on

- 1 Use the function selector to set the type of heating. The selected heating type and suggested temperature appear on the display.
- 2 If you would like to change the temperature: Turn the rotary selector to set the desired temperature.

The pre-heat symbol  appears on the display. The bars continuously display the heating status. When the set temperature has been reached, a signal sounds and the  preheat symbol goes out.

### Notes

- With a temperature setting below 160° F (70° C), the cooking compartment lighting remains switched off.
- With the "cook sous-vide" type of heating, the cooking compartment light remains switched off.

- When changing operation modes, the set temperature is retained. The suggested temperature appears only after switching on.

### Switching off:



Turn the function selector to 0.

## Misting

Misting brings additional steam to the oven interior. You can add moisture to food while cooking, for example bread and rolls.

Misting is only possible with these heating functions:

- Convection + 30% Humidity
- Convection + 0% Humidity
- Broil + circulated air
- Broil

Touch the  symbol as long as you want to add steam, up to 8 seconds. After waiting at least one second, you can trigger misting again by touching the  symbol.

## Steam removal

Steam removal brings cold water to the cooking compartment. This cools down the cooking compartment, the steam condenses on the wall of the cooking compartment. This reduces the steam escaping when opening the door.

---

### WARNING

---

#### Risk of scalding

Hot water may drip from the door when opened.

---

You can use the steam removal function only up to a temperature of 265° F (130 °C) with the following heating functions:

- Convection + 100% Humidity
- Convection + 80% Humidity
- Convection + 60% Humidity
- Broil level 1 + Humidity
- Broil level 2 + Humidity
- Sous-vide cooking

### Starting steam removal:

Touch the  symbol. Steam removal lasts about 20 seconds. The heating remains switched off during steam removal.

### Stopping steam removal prematurely:

Open the oven door or touch the  symbol

**Note:** The steam removal function remains available for a short time after turning off the appliance.

## After every use

- 1 Remove soiling from the oven interior as soon as it has cooled down. Baked-in residue is much harder to remove later on.
- 2 Wipe out the cooled down oven interior and dry them well with a soft cloth.
- 3 Wipe furnishings or handles dry if condensate has collected on them.
- 4 Dry the oven interior with the drying program (see section entitled 'Drying program') or leave the appliance door open until the interior has dried completely.

## Safety shut-off

For your protection, the appliance has a safety shut-off feature. Every heating operation is switched off after 12 hours if the appliance is not operated during this time. A message appears in the display.

Exception:  
programming with the long-term timer.

Turn the program selection to **0**, after which you can operate the appliance in the manner to which you are accustomed.

## Timer functions

In the timer menu, set:

- ⌚ Timer
- 🕒 Stopwatch
- 🕒 Cooking time (not in the idle state)
- 🕒 Cooking time end (not in the idle state)

## Launching the timer menu

You can launch the timer menu from any mode. Only from the factory settings, program selection is set to **S**, the time menu is not available.

Touch the 🕒 symbol.

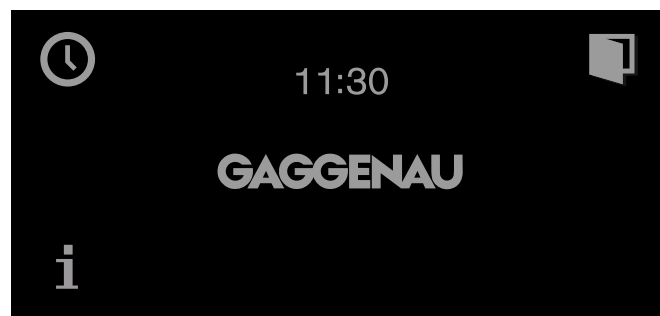

The timer menu appears.

## Timer

The timer runs independently of the other appliance functions. You can enter a maximum of 90 minutes.

### Setting the timer

- 1 Call up the Timer menu.  
The "Timer" function ⌚ is displayed.
- 2 Turn the rotary selector to set the desired time.

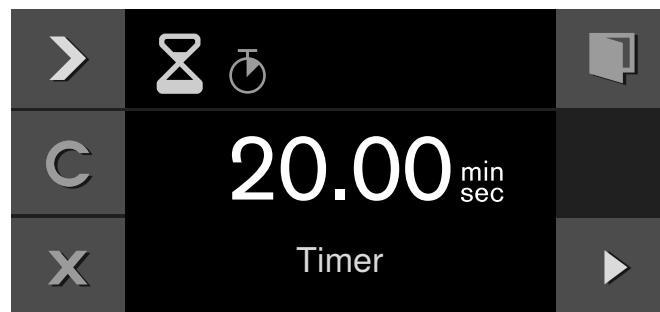

### 3 Start with ▶.

The Timer menu closes and the timer starts to run. The symbol for the timer ⌚ appears on the display and the time can be seen counting down.

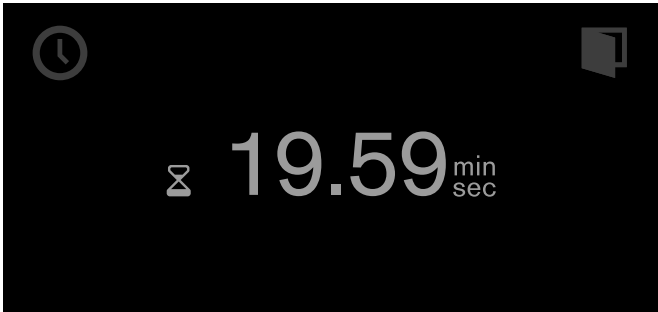

A signal sounds once the time has elapsed. The audible signal ceases if you touch the ✓ symbol.

You can exit the Timer menu at any time by touching the ✕ symbol. This way, the settings are lost.

#### Suspend timer:

Call up the Timer menu. Select the "Timer" function with ▶, select ⌚, and touch the || symbol. To let the timer run on, touch the ▶ symbol.

#### Switch off the timer early:

Call up the Timer menu. Select the "Timer" function with ▶, select ⌚, and touch the C symbol.

## Stopwatch

The stopwatch runs independently of the other appliance functions.

The stopwatch counts up from 0 seconds to 90 minutes.

It has a pause function. Therefore, you can stop the timer in between times.

#### Starting the stopwatch

- 1 Launch the timer menu.
- 2 With ▶, select the "Stopwatch" function ⌚.

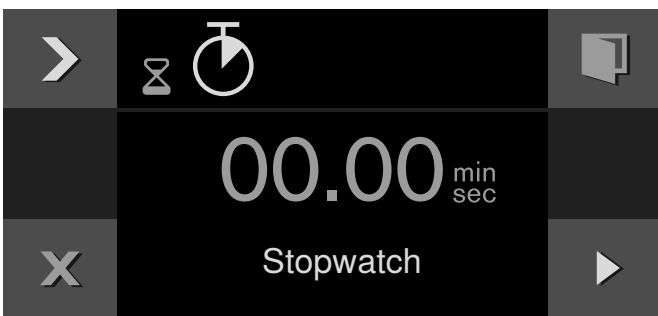

### 3 Start with ▶.

The timer menu is closed and the time runs. The ⌚ symbol and the elapsing timer are shown in the display.

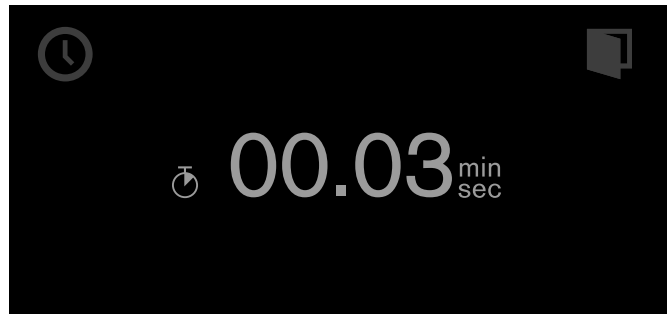

#### Stopping and restarting the stopwatch

- 1 Launch the timer menu.
- 2 With ▶, select the "Stopwatch" function ⌚.
- 3 Touch the || symbol.

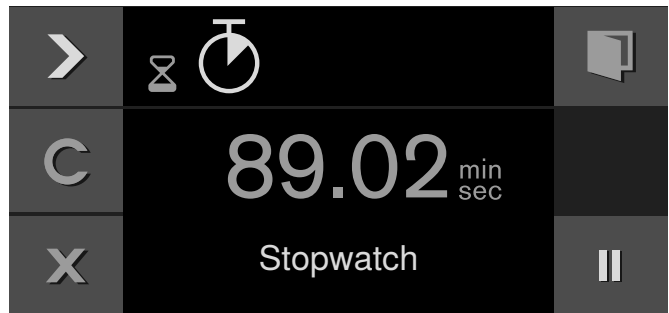

The time stops. The symbol changes to Start ▶ again.

### 4 Start with ▶.

The time continues to run. Once 90 minutes have been reached, the display pulsates and a signal sounds. It goes off when you touch the ✓ symbol. The ⌚ symbol disappears from the display. The operation has ended.

#### Switching off the stopwatch:

Launch the timer menu. With ▶, select the "Stopwatch" function ⌚ and touch the C symbol.

## Cooking time

If you set a cooking time for your meal, the appliance switches off heating automatically after this time has elapsed.

You can set a cooking time from 1 minute to 23:59 hours.

#### Setting the cooking time

You have set the heating function and temperature and you have placed your dish in the oven interior.

- 1 Touch the ⌚ symbol.
- 2 With ▶, select the "Cooking time" function ⌚.

- Set the required cooking time with the rotary selector.



- Start with ▶.

The appliance starts. The timer menu is closed. The temperature, the operating mode, the remaining cooking time and the end of the cooking time appear in the display



One minute before expiration of the cooking time, the expiring cooking time is enlarged in the display.

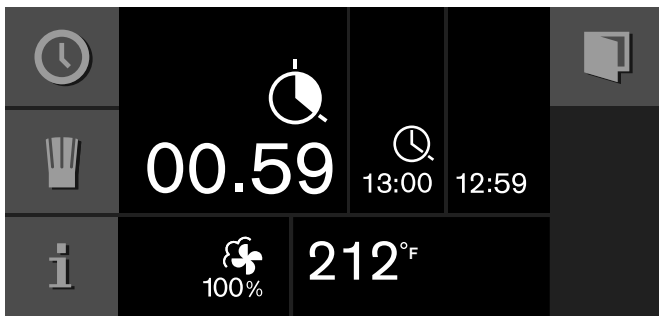

The appliance switches off after expiration of the cooking time. The ⌚ pulsates and a signal sounds. It goes off prematurely if you touch the ✓ symbol, open the appliance door or set the program selection to 0.

#### Changing the cooking time:

Launch the timer menu. With ▶, select the "Cooking time" function ⌚. Set the cooking time with the rotary selector. Start with ▶.

#### Clearing the cooking time:

Launch the timer menu. With ▶, select the "Cooking time" function ⌚. Clear the cooking time with C. Return to normal operation with X.

#### Canceling the entire operation:

Set the program selection to 0.

**Note:** You can also change the heating function and temperature during the cooking time.

## End of cooking time

You can defer the end of the cooking time until later.

Example: it is 2 pm. The meal takes 40 minutes to cook. It should be ready by 3.30 pm.

Enter the cooking time and shift the end of the cooking time to 3.30 pm. The electronic circuitry calculates the starting time. The appliance starts automatically at 2:50 pm and switches off at 3.30 pm.

Note that easily perishable foodstuffs must not be left in the oven for too long.

### Shifting the end of the cooking time

You have set the heating function, the temperature and the cooking time.

- Touch the ⌚ symbol.
- With ▶, select the "End of cooking time" function ⌚.



- Set the required cooking time end with the rotary selector.
- Start with ▶.



The appliance assumes a waiting mode. The operating mode, the temperature, the cooking time and the end of the cooking time appear in the display. The appliance starts at the calculated time and switches off automatically when the cooking time has elapsed.

**Note:** If the ⌚ symbol flashes: you have not set a cooking time. Always set a cooking time first.

The appliance switches off after expiry of the cooking time. The 🕒 pulsates and a signal sounds. It goes off prematurely if you touch the ✓ symbol, open the appliance door or set the program selection to 0.

#### Changing the cooking time end:

Launch the timer menu. With ➤, select "End of cooking time" 🕒. Set the required cooking time end with the rotary selector. Start with ▶.

#### Canceling the entire operation:

Set the program selection to 0.

---

## Sabbath mode

---

### Sabbath mode

With this function, the appliance maintains a temperature between 120 and 450°F (50 and 230°C) with the convection heating function.

You can keep dishes warm for up to 74 hours without having to switch on or off.

Note that easily perishable foodstuffs must not be left in the oven for too long.

**Note:** You must activate the Sabbath mode in the factory setting in order to operate the mode.

#### Follow these steps:

- 1 Set the program selector to S.
- 2 Select "Factory setting" with the rotary selector.
- 3 Confirm by touching the ✓ symbol.
- 4 Rotate the selector to Sabbath mode 🕒.
- 5 Confirm by touching the ✓ symbol.
- 6 Rotate the selector to "activate".
- 7 Confirm by touching the ✓ symbol.
- 8 Turn the oven off.

#### Setting the Sabbath mode

- 1 Set the program selector to 🕒.
- 2 Touch the 🕒 symbol.  
The suggested value of 24h at 185° F (85°C) appears in the display. Start with ▶  
- or -  
Change the cooking time and the temperature.

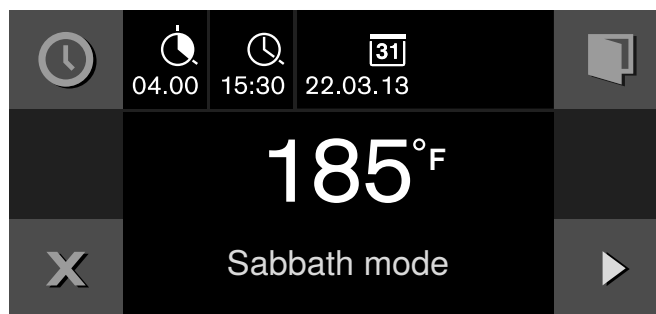

- 3 Changing the cooking time 🕒 :  
Touch the 🕒 symbol. Set the preferred cooking time with the rotary selector. You can set up to 74 hours. Confirm by touching the ✓ symbol. Then changing the temperature becomes an option.
- 4 Changing the temperature:  
Set the required temperature with the rotary selector.

## 5 Start with ►.

The appliance starts.  and the temperature appear in the display. The Sabbath screen will appear as shown.



The oven and display lighting is off. The control panel is blocked and no tone can be heard when you touch it.

The appliance no longer heats after expiry of the time. The display is blank. Set the program selector to 0.

### Switching off:

To cancel the operation, set the program selector to 0.

## Yom Tov mode

With this function, the appliance is programmed to perform in three stages.

Stage 1 and 2 can be programmed for a maximum total duration of 74 hours. The duration of Step 3 is 1 hour and cannot be modified.



**Stage 1:** maintains a warm temperature of 122° F (50°C) in the convection heating function. The interior oven lights remain off through this stage.

**Stage 2:** the appliance raises to a desired temperature setting and maintains a temperature between 120 and 450° F (50 -230°C). For warming and cooking foods in the convection heating function. The desired time can be adjusted for this stage. The interior oven lights will be on during this time.

**Stage 3:** maintains a warm temperature of 122° F (50°C) in the convection heating function for 1 hour after stage 2 has ended. The interior oven lights will be on during this time.

Note that easily perishable foodstuffs must not be left in the oven for too long.







### Setting the Yom Tov mode

- 1 Set the program selector to .
- 2 Touch the .

The suggested value of 24h at 185° F (85°C) appears in the display.



To set Stage 2 cooking time with rotary selector:

- 1 Touch the  symbol to adjust the duration of Stage 2 cooking time .
- 2 Set the desired Stage 2 cooking time with the rotary selector.
- 3 Touch the  symbol to adjust the end of Stage 2 cooking time .
- 4 Select the end time with the rotary selector.
- 5 Change the date if needed by touching the  symbol to .
- 6 Rotate the selector to the desired date.
- 7 Confirm settings by touching the  symbol.

To set Stage 2 temperature:

- 1 Rotate selector to desired Stage 2 temperature.
- 2 Start with ►.

The temperatures of Stage 1 and Stage 2 appear in the display. The remaining time to the beginning of Stage 2 is counted down in the display. The Yom Tov screen will appear as shown.

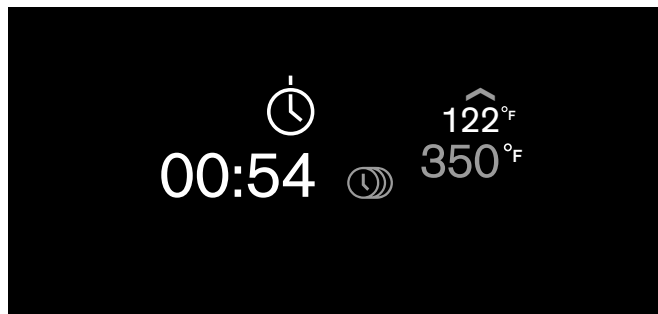

The program will begin with the pre-set warm temperature without light, then advance to the programmed temperature with light until the end of the set date and time, and then maintain the pre-set warm temperature for 60 minutes.

The appliance no longer heats after expiry of the time. The display is blank. Set the program selector to 0.

### Switching off:

To cancel the operation, set the program selector to 0.





## Personal recipes

You can save up to 50 individual recipes. You can record a recipe. You can assign these recipes a name so that you can fall back on them quickly and conveniently if you need them.

### Recording a recipe

You can set up to five phases in succession and you can record them.

- 1 Set the program selection to the required heating function.  
The  symbol is displayed.
- 2 Touch the  symbol.
- 3 Choose a free storage location with the rotary selector.
- 4 Touch the  symbol.

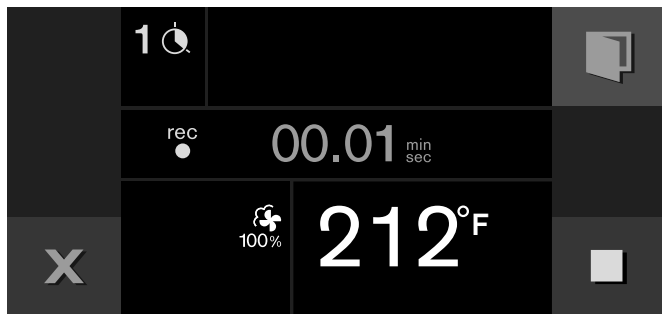



- 5 Set the desired temperature with the rotary selector.
- 6 The cooking time is recorded.
- 7 Recording another phase:  
Set the program selection to the required heating function. Set the required temperature with the rotary selector. A new phase begins.
- 8 Once the appliance has achieved the desired cooking result, touch the  symbol to end the recipe.
- 9 Enter the name under "ABC" (see section "Entering a name").

#### Notes





- Recording a phase does not begin until the appliance has reached the set temperature.
- Every phase must last at least one minute.
- During the first minute you can change the heating function or the temperature.

#### Enter the core temperature for a phase:





Insert the core temperature probe in the socket in the oven interior. Set the heating function and temperature. Touch the  symbol. With the rotary selector, enter the required temperature and confirm it with .

### Programming a recipe



You have the option of programming and saving up to five phases of preparation.

- 1 Set the program selection to the required heating function. Set the required temperature with the rotary selector.  
The  symbol is displayed.
- 2 Touch the  symbol.
- 3 Choose a free storage location with the rotary selector..
- 4 Touch the  symbol.
- 5 Enter the name under "ABC" (see section "Entering a name").
- 6 Choose the first phase with the  symbol.  
The heating function and temperature set at the start are displayed. You can change the heating function and temperature with the rotary selectors.



- 7 Choose the time setting with the  symbol.
- 8 Set the required cooking time with the rotary selector.
- 9 Choose the next phase with the  symbol.  
- or -  
Preparation is complete, end input.
- 10 Save with .  
- or -  
Cancel with  and quit the menu.

#### Enter the core temperature for a phase:

Choose the next phase with the  symbol. Set the heating function and temperature. Touch the  symbol. With the rotary selector, enter the required temperature and confirm it with .

**Note:** For phases for which a core temperature has been programmed you cannot set a cook time.

## Entering a name

- 1 Enter the recipe's name under "ABC".

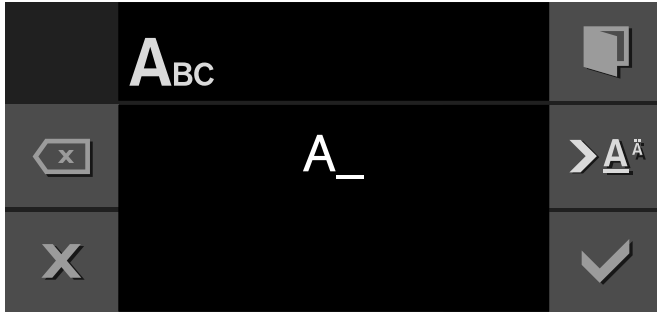

Rotary selector	Selecting letters A new word always begins with an upper case letter.
➤ Â	Press briefly: cursor to the right Press long: switch to diacritics and special characters Press twice: insert line space
➤ Ä	Press briefly: cursor to the right Press long: switch to normal characters Press twice: insert line space
⌫	Clear letters

- 2 Save with ✓.  
- or -  
Cancel with X and quit the menu..

**Note:** For entering a name, Latin characters, certain special characters and numbers are available.

## Starting a recipe

- 1 Set the program selection to any heating function. The 🍷 symbol is displayed.
- 2 Touch the 🍷 symbol. Set the required recipe with the rotary selector.
- 3 Start with ▶.  
Operation begins. Its duration elapses visibly. The settings of the phases appear in the display bar.

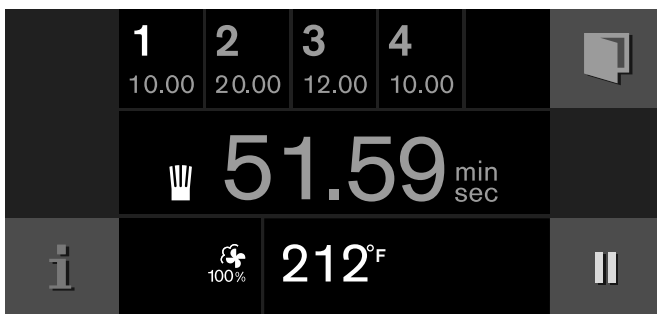

## Notes

- The cooking time does not start counting down until the appliance has reached the set temperature.
- You can use the rotary selector to change the temperature while the recipe is in progress. This does not change the saved recipe.

## Change recipe

You can change the settings of a recorded or programmed recipe.

- 1 Turn the function selector to any heating type. The 🍷 symbol is displayed.
- 2 Touch the 🍷 symbol.
- 3 Use the rotary selector to select the desired recipe.
- 4 Touch the 🍷\_ symbol.
- 5 Use the ➤ symbol to select the desired phase. The programmed heating type, temperature, and cooking time are displayed. You can change the settings with the rotary selector or the function selector.
- 6 Save with ✓.  
- or -  
Cancel with X and exit the menu.

## Deleting a recipe

- 1 Set the function selector to any type of heating. The 🍷 symbol is displayed.
- 2 Touch the 🍷 symbol.
- 3 Use the rotary selector to select the desired recipe.
- 4 Delete the recipe with C.
- 5 Confirm with ✓.

---

## Core temperature probe

---

The core temperature probe enables exact cooking to the spot. It measures the temperature inside the food being cooked. Automatic switching off when the desired core temperature is reached ensures that each cooked food is cooked precisely.

Use the included core temperature probe only. You can purchase one as a spare part from after-sales service or in the online shop.

The core temperature probe is damaged at temperatures above 480°F (250°C). Therefore, only ever use it in your appliance at a maximum temperature setting of 445°F (230°C).

Always remove the core temperature probe from the oven interior after use. Never store it in the oven interior.

After every use, clean the core temperature probe with a moist cloth. Do not wash it in a dishwasher!

---

### ⚠ WARNING

#### Risk of electric shock

Use of a wrong core temperature probe can damage the insulation. Use only the core temperature probe intended for this appliance.

---

---

### ⚠ WARNING

#### Risk of burns

The oven interior and the core temperature probe become very hot. Use oven mitts to plug and unplug the core temperature probe.

---

## Stick the core temperature probe into the food

Stick the core temperature probe into the food before you place the food in the cooking compartment.

Stick the metal spike into the thickest part of the food. Make sure that the tip of the spike is roughly in the

middle. It may not be inserted in the fat or be touching the ovenware or bones.

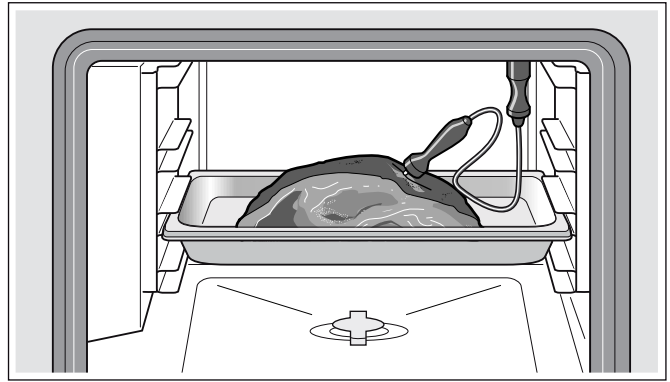

If there are several pieces of food, stick the core temperature probe into the middle of the thickest piece.

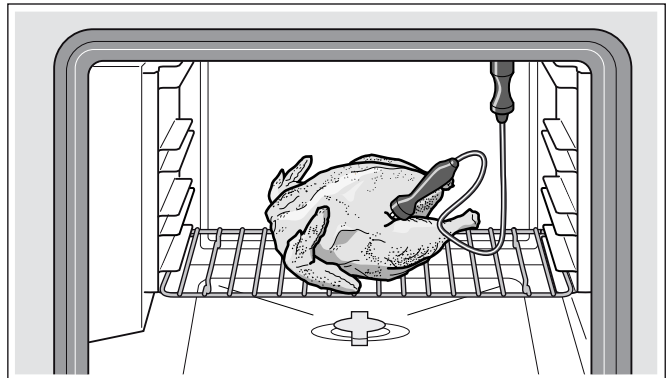

Fully insert the core temperature probe as far as possible.

With poultry, make sure that the tip of the core temperature probe is not positioned in the cavity in the middle but is located in the meat between belly and thigh.



## Setting the core temperature

- 1 Insert food into the oven interior with the core temperature probe inserted. Insert the core temperature probe in the socket in the oven interior and close the appliance door.  
Do not jam the core temperature probe's cable!  and the current core temperature appear in the display.
- 2 Set the program selection to the required heating function.
- 3 Set the oven interior temperature with the rotary selector.

- 4 Touch the  symbol. With the rotary selector, set the required core temperature and confirm it with . The set core temperature must be higher than the current core temperature.

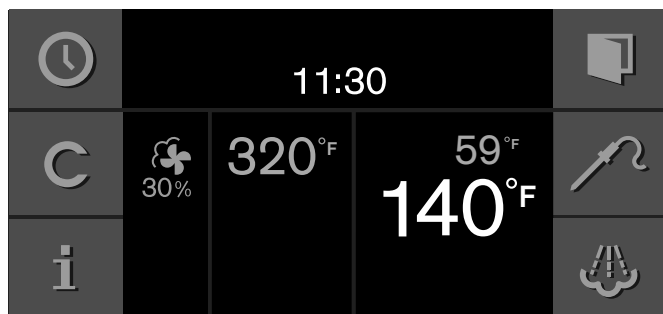



- 5 The appliance heats with the set heating function. The current core temperature is displayed and, under it, the set core temperature. You can change the set core temperature at any time.

A signal sounds when the set core temperature in the food has been reached. The cooking mode is ended automatically. Confirm with  and turn the program selection to 0.

#### Notes

- The measurable range is 59 to 210° F (15 to 99° C). Outside the measurable range, "--°F" is displayed for the current core temperature.
- If you leave the food in the cooking compartment for some time after cooking, the core temperature will continue to rise somewhat due to the residual heat in the cooking compartment.
- If at the same time you adjust a programming with the core temperature probe and the cooking time timer, then the programming switches the device off that reaches the specified value first.

#### Changing the core temperature set:

Touch the  symbol. Use the rotary selector to change the set core temperature for the food and confirm with .

#### Deleting the core temperature set:

Touch the  symbol. Delete the set core temperature with **C**. The appliance continues heating in normal cooking mode.

## Core temperature guidelines

Use chilled food only, not frozen food. The details given in the table are guidelines. Results depend on the quality and composition of the food.

For hygiene reasons, critical foodstuffs such as fish and game should reach a core temperature of 143 - 158° F (62 - 70 °C); for poultry and minced meat this should be as high as 176 - 185° F (80 - 85 °C).

Food	Core temperature guideline
<b>Beef</b>	
Sirloin, tenderloin, entrecôte	
very rare	113 - 117°F (45 - 47 °C)
rare	122 - 126°F (50 - 52 °C)
medium	137 - 140°F (58 - 60 °C)
well-done	158 - 167°F (70 - 75 °C)
Roast beef	176 - 185°F (80 - 85 °C)
<b>Pork</b>	
Pork roast	162 - 176°F (72 - 80 °C)
Pork loin	
medium	149 - 158°F (65 - 70 °C)
well-done	167°F (75 °C)
Meat loaf	185°F (85 °C)
Fillet of pork	149 - 158°F (65 - 70 °C)
<b>Veal</b>	
Veal roast, well-done	167 - 176°F (75 - 80 °C)
Breast of veal, stuffed	167 - 176°F (75 - 80 °C)
Saddle of veal	
medium	137 - 140°F (58 - 60 °C)
well-done	149 - 158°F (65 - 70 °C)
Fillet of veal	
rare	122 - 126°F (50 - 52 °C)
medium	137 - 140°F (58 - 60 °C)
well-done	158 - 167°F (70 - 75 °C)
<b>Game</b>	
Saddle of venison	140 - 157°F (60 - 70 °C)
Leg of venison	158 - 167°F (70 - 75 °C)
Venison loin steaks	149 - 158°F (65 - 70 °C)
Saddle of hare or rabbit	149 - 158°F (65 - 70 °C)

Food	Core temperature guideline
<b>Poultry</b>	
Chicken	195°F (90 °C)
Guinea fowl	175 - 185°F (80 - 85 °C)
Goose, turkey, duck	185 - 195°F (85 - 90 °C)
<b>Duck breast</b>	
medium	131 - 140°F (55 - 60 °C)
well-done	158 - 176°F (70 - 80 °C)
Ostrich steak	140 - 149°F (60 - 65 °C)
<b>Lamb</b>	
<b>Leg of lamb</b>	
medium	140 - 149°F (60 - 65 °C)
well-done	158 - 176°F (70 - 80 °C)
<b>Saddle of lamb</b>	
medium	131 - 140°F (55 - 60 °C)
well-done	149 - 167°F (65 - 75 °C)
<b>Mutton</b>	
<b>Leg of mutton</b>	
medium	158 - 167°F (70 - 75 °C)
well-done	176 - 185°F (80 - 85 °C)
<b>Saddle of mutton</b>	
medium	158 - 167°F (70 - 75 °C)
well-done	176 °F (80 °C)
<b>Fish</b>	
Fillet	144 - 149°F (62 - 65 °C)
Whole	149°F (65 °C)
Terrine	144 - 149°F (62 - 65 °C)
<b>Other provisions</b>	
Bread	205°F (96 °C)
Paté	162 - 167°F (72 - 75 °C)
Terrine	140 - 158°F (60 - 70 °C)
Foie gras	113°F (45 °C)

## Childproof lock

The appliance has a panel lock to make sure children cannot operate it inadvertently.

### Notes

- You must set the child lock in the factory setting to "Available"
- If there is a power cut while the child lock is activated, it may be deactivated when the power returns.

## Activating the child lock

### Requirement:

Program selector is set to 0.

Touch the  symbol for at least 6 seconds.

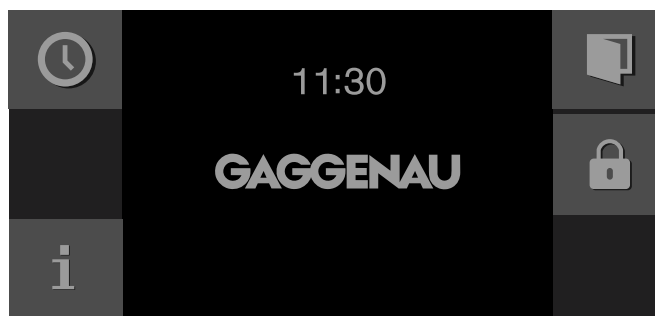

The child lock is activated. The standby screen appears. The  appears at the top of the display.

## Deactivating the child lock

### Requirement:

Program selector is set to 0.

Touch the  symbol for at least 6 seconds.

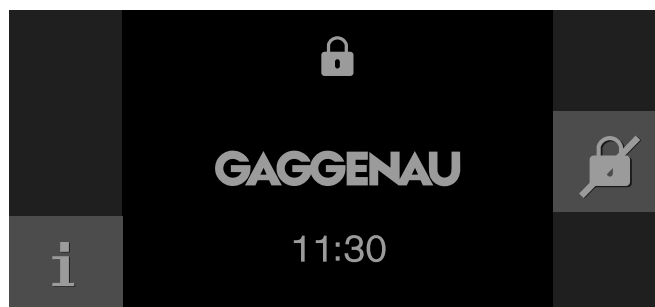



The child lock is deactivated. You can switch on the appliance in the usual manner.















## Factory setting













In the general settings, you can adapt your appliance individually.

- 1 Set the program selector to **S**.
- 2 Select "General setting" with the rotary selector.
- 3 Touch the  symbol.
- 4 Set the required general setting with the rotary selector.

- 5 Touch the  symbol.
- 6 Set the general setting with the rotary selector.
- 7 Save with  or cancel with  and quit the current general setting.
- 8 Turn the program selector to **0** to quit the general setting menu.

Changes are saved.

	Basic setting	Possible settings	Explanation
	Brightness	Stages 1, 2, 3, 4, 5*, 6, 7, 8	Setting display brightness
	Standby screen	On*/Off - Clock - Clock + GAGGENAU logo* - Date - Date + GAGGENAU logo - Clock + date - Clock + date + GAGGENAU logo	Appearance of the standby screen. Off: no display. Use this setting to reduce the standby consumption of your appliance. On: several displays can be set, confirm "On" with  and choose the desired display with the rotary selector. The selection is displayed.
	Display screen	Minimized*/Standard	When 'Minimized' is set, only the most important details are displayed after a short time.
	Touchpad color	Gray*/White	Select the color of symbols on the touchpads
	Touchpad tone	Tone 1*/Tone 2/Off	Select the signal tone when touching a touchpad
	Touchpad volume	Levels 1, 2, 3, 4, 5*, 6, 7, 8	Sets the volume of the touchpad tone
	Preheating signal	On*/Off	The signal tone sounds when the required temperature is reached during preheating.
	Signal volume	Levels 1, 2, 3, 4, 5*, 6, 7, 8	Sets the volume of the signal tone
	Water filter	Available* / not available	Available: use appliance with water filter. Not available: use appliance without water filter.
	Water filter capacity	100 - 9000 liters	Set the water filter capacity
	Water hardness	1-18	Check mains water with the included carbon hardness test. Set the measured water hardness.
	Calibration	Calibrating the appliance	Setting the boiling point
	Time format	AM/PM / 24 h*	Time display in 24 or 12-hour format

	Time	Current time	Setting the time
	Daylight savings	Manual*/Automatic	Automatic time changeover when changing daylight savings time. If automatic: setting of the month, day and week when the time is to be changed. To be set separately for summer and winter time.
	Date format	D.M.Y* D/M/Y M/D/Y	Setting the date format
	Date	Current date	Setting the date. Switch between the year/month/day with the > symbol.
	Temperature unit	°C* / °F	Setting the temperature unit
	Language	German* / French / Italian / Spanish / Portuguese / Dutch / Danish / Swedish / Norwegian / Finnish / Greek / Turkish / Russian / Polish / Czech / Slovenian / Slovakian / Arabic / Hebrew / Japanese / Korean / Thai / Chinese / English US / English	Select language for the text display <b>Note:</b> When the language is changed, the system is restarted; this procedure takes a few seconds. Then the General settings menu is closed.
	Factory settings	Restore appliance to factory settings	Confirm the question "Delete all individual settings and restore appliance to factory settings?" with ✓ or cancel with X. <b>Note:</b> When restoring factory settings, the personal recipes are also deleted. After restoring the factory settings, you will see the "Initial settings" menu.
	Demo mode	On/Off*	For presentation purposes only. The appliance does not heat in the demo mode, but all other functions are available. The "Off" setting must be activated for normal operation. The setting is only possible in the first three minutes after connecting the appliance.
	Cleaning program demo	Start cleaning program demo	For presentation purposes only. No cleaning and heating function. The demo cleaning program takes 10 minutes. It can be ended at any time. You need a new or previously-used standard cleaning cartridge. The appliance must be connected to the water and waste water lines. Dry the cooking compartment manually afterwards.
	Sabbath mode	Not Available* / Available	Available: Sabbath mode can be set; see the section entitled 'Sabbath mode'.
	Door lock	Off*/On	The door lock prevents unintentional opening of the appliance door. When "On" is set, you must touch the  symbol for several seconds before the door opens.



Child lock

Not Available\* / Available

Available: the child lock can be activated (see section entitled 'Child lock').

\* Factory settings

## Cleaning and maintenance

If taken care of and cleaned conscientiously, your appliance will stay beautiful and intact for a long time. Here we explain how to take care of and clean your appliance correctly.

### WARNING

#### Risk of electrical shock

Moisture entering the appliance can cause an electrical shock. Don't use a high-pressure cleaner or steam cleaner.

### WARNING

#### Risk of burns

- To avoid risk of injury, never touch the inside surfaces of the oven interior or heating elements. These surfaces are extremely hot after use. Always allow the appliance to cool down before touching or cleaning the interior.
- Always turn off the interior light before cleaning the oven to allow the bulbs to cool down. The bulbs can become very hot when switched on. Keep the light off while cleaning the oven.
- Keep children away.

### WARNING

#### Risk of injury

Scatched glass in the appliance door can burst. Do not use any glass scrapers or strong or abrasive cleaning agents.

### WARNING

Do not clean the appliance while it is still hot. Some cleaners produce noxious fumes when applied to a hot surface. Wet clothes and sponges can cause burns from steam.

## Cleaning agents

Pay attention to the information in the table to ensure that the various surfaces are not damaged by incorrect cleaning agents.

Do not use any

- sharp or abrasive cleaning agents
- metal or glass scrapers to clean the glass on the appliance door.
- metal or glass scrapers to clean the door seal.
- hard abrasive pads or cleaning sponges.

Thoroughly rinse out new sponge cloths before use.

Area	Cleaning agent
Door panels	Glass cleaner: Clean with a soft cloth and dry with a microfiber cloth. Do not use a glass scraper.
Display	Wipe down using a microfiber cloth or a slightly damp cloth. Do not wipe with a wet cloth.
Stainless steel	Hot soapy water: Clean using a dish cloth and then dry with a soft cloth. Remove flecks of lime scale, grease, starch and albumin (e.g. egg white) immediately. Corrosion can form under such flecks. Special stainless-steel cleaning agents are available from customer service or from specialist retailers.
Aluminum	Clean with a mild window cleaning agent. Using a window cloth or a lint-free microfiber cloth, wipe over the surfaces lightly in a horizontal direction.



Area	Cleaning agent
Cooking compartment	<p>Hot soapy water: Clean with a dish cloth and dry with a soft cloth.</p> <p>Do not use oven spray and other aggressive oven cleaners or abrasive materials. Scouring pads, rough sponges and pan cleaners are also unsuitable. These items scratch the surface.</p> <p>Always dry the cooking compartment after cleaning (see "Drying program" chapter).</p> <p>For regular care of the stainless steel cooking compartment, use cleanser according to the manufacturer's instructions (order number 667027 from customer service or in the online shop).</p> <p><b>NOTICE:</b> Undissolved detergent causes flecks when heating up. Remove all detergent and care product residues thoroughly with water before drying the cooking compartment.</p>
Very dirty cooking compartment	The cleaning program removes stubborn dirt (see "Cleaning program" chapter).
Glass ceramic grilling surface (only version with grill)	Clean the glass ceramic grilling surface in the cooking compartment regularly with glass ceramic cleaner (order number 311298 from customer service or in the online shop). Clean burned-on residues with a glass scraper.
<p><b>⚠ CAUTION</b></p> <p>Do not scratch the cooking compartment with the glass scraper.</p>	
Glass cover for the cooking compartment light	Hot soapy water: Clean with a dish cloth.
Door seal	Hot soapy water: Clean with a dish cloth and do not scour. Do not use a metal or glass scraper for cleaning.
Core temperature probe	Wipe with a damp cloth. Do not place in the dishwasher.
Cooking container, wire rack	Dishwasher or hot soapy water. Soak burned-on residues and clean with a brush.

#### Microfiber cloth

The honeycomb microfiber cloth is particularly suitable for cleaning sensitive surfaces such as glass, glass ceramic, stainless steel or aluminum (product no. 00460770, also available from our online online shop). It removes liquid and greasy deposits in one go.

#### Drain filter

Clean the drain filter on the bottom of the cooking compartment as necessary. With frequent preparation of fish or meat, we recommend monthly cleaning.

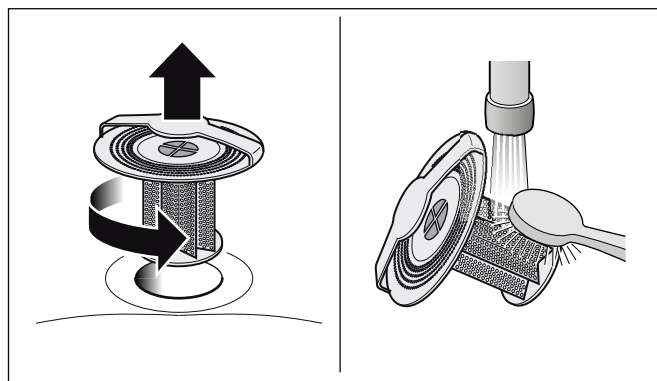

- 1 Turn the drain filter to the left and remove it.
- 2 Remove food residues from the drain sieve.
- 3 Rinse out under running water. If heavily soiled, clean in the dishwasher.
- 4 Insert the drain filter and turn right to the stop.

Never operate the combination steam oven without the drain filter.

#### Enameled cooking compartment

The enamel in the cooking chamber gets lighter with use. The change in the color does not affect use user benefits. Do not try to remove the coloring by scouring with abrasive materials.

## Cleaning program

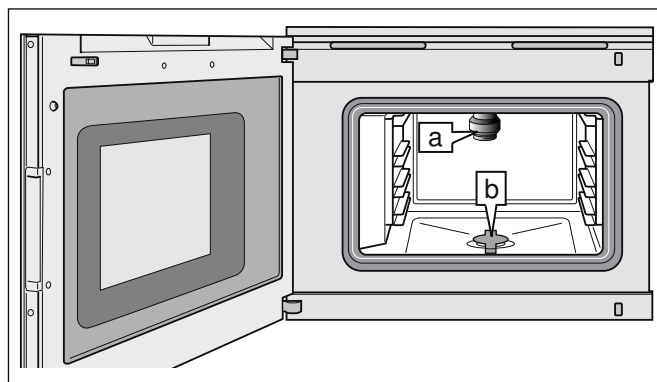

The cleaning program removes stubborn dirt. A cleaning cartridge (a) is screwed into the top of the cooking compartment. The cooking compartment is cleaned, rinsed, and dried completely automatically. The drain filter (b) must remain inserted in the cooking compartment floor while the cleaning program is in progress.

The complete cleaning program takes 3 hours and 45 minutes.

With normal use, we recommend cleaning the appliance with the cleaning program four times a year. Depending on the use, more frequent cleaning can be necessary.

Do not let heavy dirt burn in; instead, start the cleaning program immediately after use.

You need special cleaning cartridges for the cleaning program. These are available from customer service or from the online shop (CL 510 04 0 set with 4 cleaning cartridges, order number 00311703).



The cleaning cartridges can only be used once and are not refillable. Do not use any other cleaner.

**NOTICE:** Damage to the cooking compartment: Use cleaning cartridges only for the cleaning program. Never place cleaning cartridges in the hot cooking compartment or heat them in the cooking compartment.

### Notes

- The cleaning program can only be started if the appliance is cooled off below 104°F (40°C).
- Remove all accessories from the cooking compartment before you start the cleaning program (wire rack, cooking containers, core temperature probe).
- Remove the worst soiling from the cooking compartment.
- The drain filter must remain inserted in the cooking compartment floor while the cleaning program is in progress. If the drain filter is removed before the cleaning program is started, the cooking compartment will not be clean at the end of the program.
- The appliance door is locked during the cleaning program.
- Do not try and open the appliance door during the cleaning program. Water could escape.
- Always leave the cleaning program run to the end. The cleaning program cannot be canceled.

### Starting the cleaning program

- 1 Set function selector to **S**.
- 2 The  symbol is displayed. Press  to confirm.
- 3 The switch-off time is displayed at which the cleaning program will end. If desired, move switch-off time with the rotary selector. Press  to confirm. The starting time and switch-off time are shifted, the cleaning time remains the same.



- 4 Remove all accessories from the cooking compartment and remove the coarse dirt. Press  to confirm.
- 5 Remove the locking cap from the cleaning cartridge.

### CAUTION

Do not remove the wax plugs from the opening of the cleaning cartridge. Do not use any other detergents. Do not use damaged cartridges.

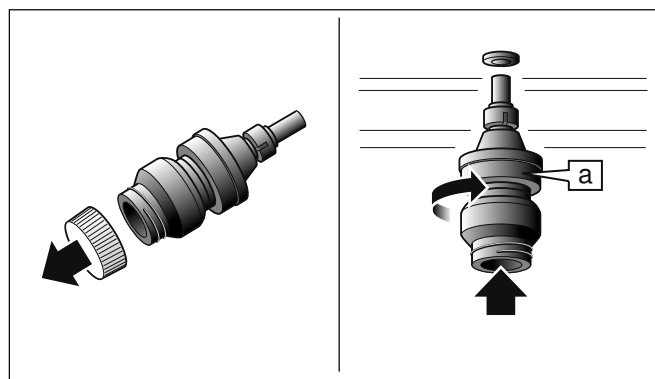

- 6 Screw the cleaning cartridge (a) as far as it will go into the socket in the top of the cooking compartment. Close the appliance door. Press  to confirm. A cleaning time of 3 hours, 45 minutes is displayed.

- 7 Start with ►. The cleaning time counts down on the display. The light in the cooking compartment remains switched off. The appliance door is locked.

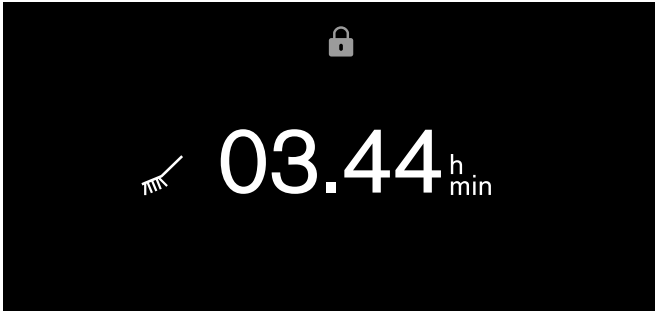

After the cleaning program has finished, a signal sounds. The appliance door is unlocked. A message appears on the display.

- 8 Remove the cleaning cartridge.  
**NOTICE:** Damage to the cooking compartment: never heat the appliance up if a cartridges has been inserted.
- 9 Turn the drain filter on the cooking compartment floor to the left and remove it. Remove food residues from the drain sieve. Rinse out under running water.

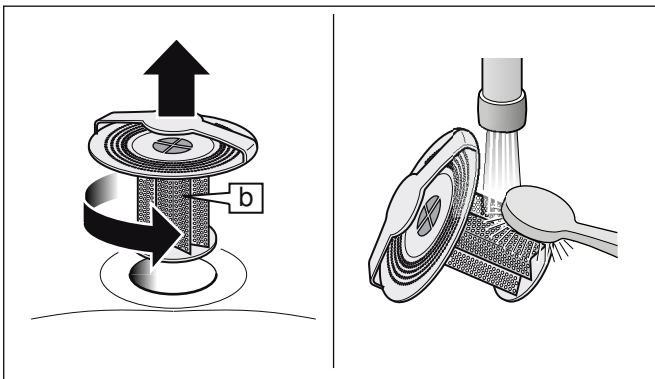

- 10 Insert the drain filter and turn right to the stop. Press ✓ to confirm.

The cleaning program is complete. Allow the appliance to cool down. Then polish the cooking compartment and the glass with a soft cloth.

Dispose of the empty cleaning cartridge in accordance with regional regulations for household garbage.

### Causes of an unsatisfactory cleaning result

If the cooking compartment is still not clean once the cleaning program has ended, use the table below to help you identify the causes. Then insert a new cleaning cartridge and start the cleaning program again.

Possible cause	Solution
Locking cap on the cleaning cartridge	The locking cap has not been removed from the cleaning cartridge.  Once the cleaning program has finished, remove the cartridge from the appliance. Do not reuse the cartridge. Dispose of the cartridge in accordance with the local regulations.
<p><b>⚠ WARNING</b></p> <p><b>Risk of injury</b></p> <p>To prevent the cleaner from coming into contact with the skin or eyes, do not remove the locking cap from a spent cartridge.</p>	
Wrong cartridge (descaling cartridge)	Use only original cleaning cartridges for the cleaning program.
Drain filter not inserted	The drain filter must remain inserted in the cooking compartment floor while the cleaning program is in progress.
Power failure	Following a power failure that lasts longer than 3 minutes, the cleaning program is ended with a short program.
Heavy burnt-in dirt	Run cleaning program again in order to remove stubborn dirt.

### Drying program

With the drying program, you can dry the cooking compartment after cleaning or after steaming.

The drying program takes 20 minutes.

#### Starting the drying program

- 1 Remove accessories from the cooking compartment. Wipe out the cooking compartment. Thoroughly remove residues of cleaner. Close appliance door.
- 2 Set the function selector to **S**. Select the drying program with the rotary selector.
- 3 The broom icon is displayed. Confirm with ✓.

- The drying time of 20 minutes appears. Touch ▶ to start. The drying time elapses on the display. The lamp in the cooking compartment stays off.

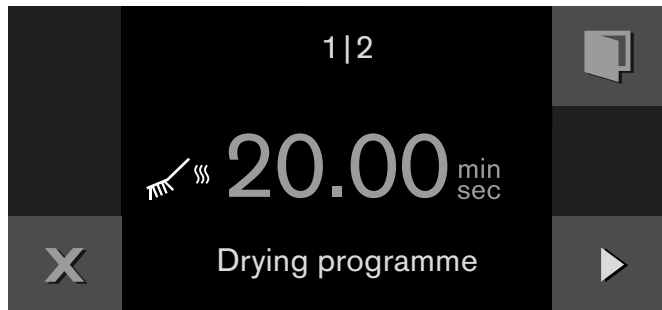

- A signal sounds after 20 minutes. A message appears in the display. Confirm with ✓.

The drying program has ended. Allow the appliance to cool down. Then polish the cooking compartment and the panel with a soft cloth.

## Descaling program

Regular descaling maintains the good condition of the cooking compartment. The cooking compartment is descaled, rinsed, and dried completely automatically with the descaling program.

Depending on the type of water and use of the appliance, a message on the display reminds you that the descaling program should be run. If necessary (e.g. with scaling in the cooking compartment), you can run the descaling program more frequently.

The complete descaling program takes 2 hours 15 minutes.

For the descaling program, you need special descaling cartridges. These are available from customer service or from the online shop (CL S20 040 set with 4 descaling cartridges, order number 00311768).

**NOTICE:** Damage to the cooking compartment: Only use descaling cartridges for the descaling program. Never place descaling cartridges in the hot cooking compartment or heat them in the cooking compartment.

### Notes

- The descaling program can only be started if the appliance has cooled down below 104°F (40°C).
- Remove all accessories from the cooking compartment before you start the descaling program (wire rack, cooking containers, core temperature probe).
- The drain filter must remain inserted in the cooking compartment floor while the descaling program is in progress.

- The appliance door is locked during the descaling program.
- Always leave the descaling program run to the end. The descaling program cannot be canceled.
- Even with use of the descaling and taste filter (special accessories GF 111 100), depending on the water type and use of the appliance, descaling may be necessary. A message appears on the display reminding you of this.

### Starting the descaling program

- Set function selector to S. Use the rotary selector to select the descaling program.
- The broom icon is displayed. Press ✓ to confirm.
- The switch-off time is displayed at which the descaling program will end. If desired, move switch-off time with the rotary selector. Press ✓ to confirm.

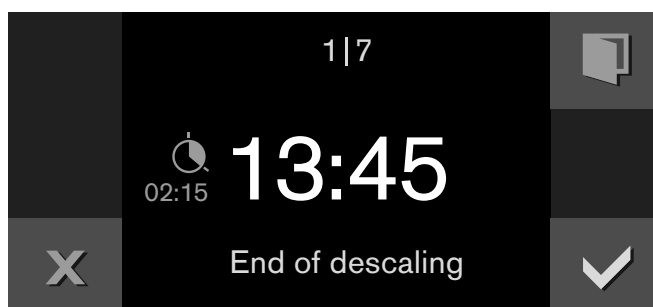

- Remove all accessories from the cooking compartment. Press ✓ to confirm.
- Remove the locking cap from the descaling cartridge.

### ⚠ CAUTION

Do not remove the wax plugs from the opening of the descaling cartridge. Do not use any other descaler.

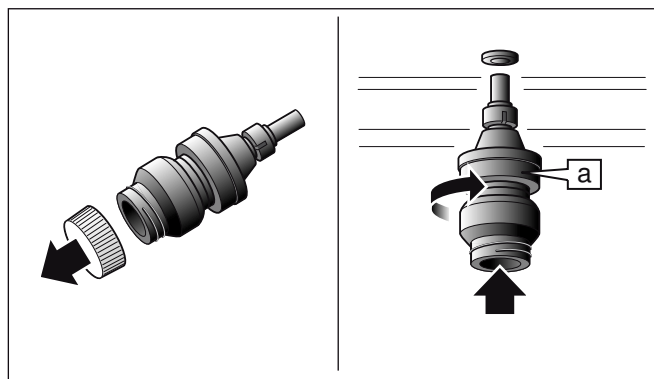

- Screw the descaling cartridge (a) into the socket in the top of the cooking compartment up to the stop. Close the appliance door. Press ✓ to confirm. A descaling time of 2 hours 15 minutes is displayed.

- 7 Start with ►. The descaling time counts down on the display. The light in the cooking compartment remains switched off. The appliance door is locked.

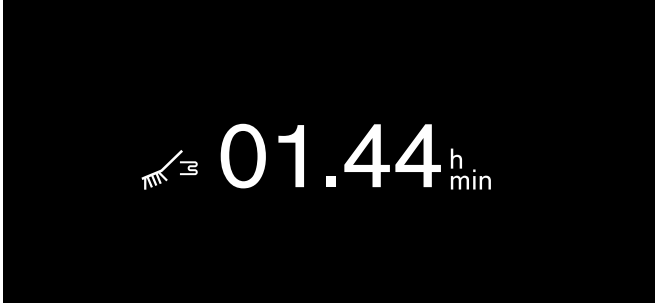

After the descaling program has finished, a signal sounds. The appliance door is unlocked. A message appears on the display.

- 8 Remove the descaling cartridge. Press ✓ to confirm.
- 9 Turn the drain filter on the cooking compartment floor to the left and remove it. Remove food residues from the drain sieve. Rinse out under running water.
- 10 Insert the drain filter and turn right to the stop. Press ✓ to confirm.

The descaling program has finished. Then delete the descaling notice in the display. Press ✓ to confirm.

Allow the appliance to cool down. Then polish the cooking compartment and the glass with a soft cloth.

Dispose of the empty descaling cartridge in accordance with regional regulations for household garbage.





## Troubleshooting

You can often easily eliminate problems that may occur on your own. Before calling customer service, take into account the following information.

### WARNING

#### Risk of electric shock

Improper repairs are dangerous. Only an authorized servicer may perform repairs and may replace damaged plug and connections. Remove the power plug or turn off the circuit breaker or fuse in the fuse box if the appliance is damaged or not working. Call Customer Service.

Disruption	Possible cause	Solution
Appliance not working, no display	Plug not inserted	Connect the appliance to the electricity mains
	Power failure	Check whether other kitchen appliances are working
	Fuse defective	Check in the fuse box whether the fuse for the appliance is in working order
	Operating error	Switch off the fuse for the appliance in the fuse box and switch it on again after about 10 seconds
Appliance cannot be started	Appliance door is not quite closed	Close appliance door
Appliance is not working, display is not responding.  appears in the display.	Child lock activated	Deactivate child lock (see section entitled 'Child lock')
Appliance switches off automatically	Safety deactivation: the appliance has not been operated for longer than 12 hours	Confirm the message with  , switch off the appliance and set it again.
Appliance does not heat up,  appears in the display	Appliance is in the demo mode	Deactivate demo mode in the basic settings
Appliance will not start, a message appears in the display	No water in the appliance	Check water intake
No steam visible	Steam is not visible above 212° F (100° C)	This is normal
Grill heating element is only hot at the edge, not the middle	The grill tray heats only the edges in order to provide optimal heat distribution	This is normal
The  "steam removal" symbol does not appear	You can use the steam removal function only up to a temperature of 266° F (130 °C)	This is normal
Extreme amounts of steam emerging at the top of the door	Appliance is calibrating the boiling point or is preheating or the mode has been changed	This is normal
	Boiling point has not yet been adjusted	Adjust the boiling point
Extreme amounts of steam emerging at the side of the door	Door seal soiled or loose	Clean the door seal and insert it in the groove
Humming when turned on	Water outlet pump is warming up	Normal operating sound
	Appliance was not used for a few days	Normal: automatic rinsing at start up
There is a 'plop' noise during cooking	Stress expansion in the event of a large temperature difference	This is normal
Appliance does not steam properly any more	Appliance is clogged with scale	Start the descaling program
The cooking compartment is wet after operation	This is normal depending on the operating mode set by the user	After operation, dry the cooking compartment using the drying program

## Power cut

Your appliance can bridge a power cut of a few seconds. Operation continues.

If the power cut was for a longer period and the appliance was in operation, a message appears in the display. Operation is interrupted.

Set the function selector to **0**, then the appliance can be operated again as usual.

## Demo mode

The demo mode is activated if the  symbol appears in the display. The appliance does not heat up.

Briefly disconnect the appliance from the mains (switch off the domestic fuse or the circuit-breaker in the fuse box). Then deactivate the demo mode within 3 minutes in the factory setting.

## Replacing the oven interior lamp

For technical reasons, the lamp cover is not detachable. Only Gaggenau after-sales service may replace the lamp.

---

### CAUTION

Do not detach the lamp cover. This would damage the seal.

---

The lamp cover in the oven must be replaced if it is damaged. You can obtain covers from after-sales service. Always specify the E number and the FD number of your appliance.

---

## Customer service

---

If your appliance needs repairs, our customer service is there for you. We work hard to help solve problems quickly and without unnecessary service calls, getting your appliance back up and running correctly in the least amount of time possible.

When you call, please indicate the product number (E-Nr.) and serial number (FD-Nr.) so that we can support you in a qualified manner. You will find the type plate with these numbers on the bottom of the appliance. To avoid having to search for a long time when you need it, you can enter your appliance data and the customer support telephone number here.

---

**E-Nr.**

**FD-Nr.**

---

---

**Customer Service** 

---

Please read the use and care instructions provided with your appliance. Failure to do so may result in an error in using the appliance. This could result in a service call that instead of fixing a mechanical issue is only needed for customer education. Such calls are not covered by the appliance warranty.

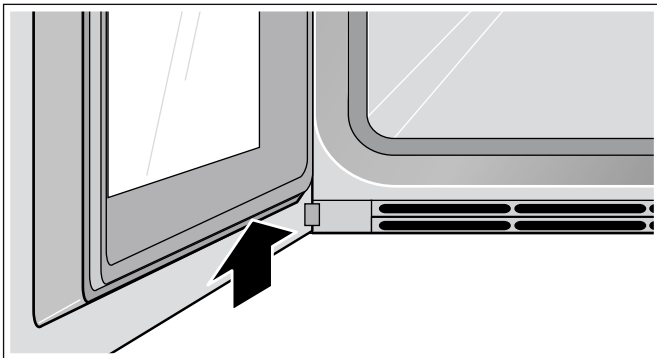

Please find the contact data of all countries in the enclosed customer service list.

**To book a service visit and product advice**

**USA**            877 442 4436  
                     toll-free

**CANADA**      877 442 4436  
                     toll-free



## Tables and tips

### Notes

- The cooking times specified are intended as a guide. The actual cooking times depend on the quality and temperature of the food before cooking, the weight and thickness of the food to be cooked.
- Always preheat the appliance. Here's how to get the best cooking results.  
The cooking times specified refer to a pre-heated appliance. Add approximately 5 minutes to these times if you are placing food into the appliance without preheating it.
- The specifications refer to average quantities for four people. If you would like to prepare more, you should calculate a longer cooking time.
- Use the cookware specified. If you use other cookware, cooking times may be longer or shorter.
- If you have not made a particular dish before, use the shortest time specified to start with. You can extend the cooking time if necessary.
- Open the cooking compartment door of the preheated oven for a short time only and do not take too long to place your food inside the appliance.
- When using only one cooking container, place it in the appliance at the second level from the bottom.
- When steaming, defrosting, cooking and reheating, you can use up to three rack levels at a time (rack levels 2, 3 and 4 from the bottom). This will not cause flavor to transfer. This allows fish, vegetables and desserts to be prepared at the same time. However, the specified cooking times may need to be extended for large quantities of food.
- Only one level can be used for baking; the second level from the bottom is designated for this.
- Do not allow the food to come into contact with the cooking compartment, grease filter or back panel of the oven.
- The combination steam oven must shut properly. Keep the seal surfaces clean at all times.
- Do not place too many items close together on wire racks or containers. This is to ensure an optimal steam circulation.
- If you wish to prepare food using steam and the appliance has been heated to over 212° F (100 °C) (for example because it has just been used for baking), allow the appliance to cool down before steaming your food. Otherwise, the high temperature will cause your food to dry out.

## Vegetables

- Vegetables are prepared better in steam than in boiling water: the taste, color, and consistency are retained better. Water-soluble vitamins and nutrients are hardly washed out. Since the combination steam oven works without pressure at just 212° F (100°C), the preparation is much gentler than in a pressure cooker, for example.
- All details refer to 1 kg (2 lb) washed vegetables.
- For steaming vegetables, use the perforated cooking insert; insert it in the second level from the bottom. Insert the unperforated cooking insert underneath it. Use the vegetable broth as the basis for a sauce or a vegetable stock.
- Blanching takes 8 - 10 minutes in the pre-heated appliance. If the vegetables or fruit will not be served immediately, chill in ice water to prevent continued cooking due to residual heat.

Food	Cooking container	Temperature in °F (°C)	Humidity in %	Cooking time in min.	Observations
Artichokes, large	perforated	212 (100)	100	30 - 40	
Artichokes, small	perforated	212 (100)	100	20 - 25	
Cauliflower, whole	perforated	212 (100)	100	25 - 30	
Cauliflower, in florets	perforated	212 (100)	100	15 - 25	
Beans, green	perforated	212 (100)	100	25 - 30	
Broccoli, in florets	perforated	212 (100)	100	15 - 20	Recipe tip: serve with almonds roasted in butter.
Fennel, in slices	perforated	212 (100)	100	15 - 20	

Food	Cooking container	Temperature in °F (°C)	Humidity in %	Cooking time in min.	Observations
Vegetable terrine	perforated/ wire rack	212 (100)	100	50 - 60	In a terrine mold  For precise cooking point control, use the core temperature probe (see "core temperature probe" chapter).
Carrots, in slices 0.5 cm (0.2 in)	perforated	212 (100)	100	15 - 20	
Potatoes, peeled and quartered	perforated	212 (100)	100	25 - 35	
Kohlrabi, in slices	perforated	212 (100)	100	20 - 30	
Leeks, in slices	perforated	212 (100)	100	10 - 15	
Pepper, stuffed	unperforated	355 - 390 (180 - 200)	80 / 100	20 - 25	With meat filling, brown the filling in advance.
Unpeeled boiled potatoes (approx. 2 oz apiece)	perforated	212 (100)	100	30 - 35	
Unpeeled boiled potatoes (approx. 4 oz apiece)	perforated	212 (100)	100	45 - 50	
Brussels sprouts	perforated	212 (100)	100	20 - 25	
Asparagus, green	perforated	212 (100)	100	12 - 15	
Asparagus, white	perforated	212 (100)	100	20 - 30	
Spinach	perforated	212 (100)	100	4 - 6	Then sweat in a pot with onions and garlic.
Peeled tomatoes	perforated	212 (100)	100	3 - 4	Cut tomatoes in, after steaming, chill with ice water
Snap peas	perforated	212 (100)	100	5 - 10	

## Fish

- Steaming is a fat-free way of cooking food, with which the fish does not dry out.
- Fish should (for hygienic reasons) have a core temperature of at least 143 - 149° F (62 - 65°C) after cooking. This is also the ideal cooking point.
- Only salt the fish after cooking. Thus the natural aroma is retained and less water is removed from the fish.
- If you are using the perforated cooking container: you can grease the container if the fish sticks too much.
- Insert the unperforated cooking insert into the first level from the bottom to prevent soiling the cooking compartment with fish juices.
- For fillets with skin: if you place the fish skin-side up, the structure and aroma will be retained better.

Food	Cooking container	Temperature in °F (°C)	Humidity in %	Cooking time in min.	Observations
Gilthead bream, whole (500 g / 1 lb 2 oz)	unperforated	195 - 212 (90 - 100)	100	18 - 20	Can be cooked in swimming position if you set it on half a potato.
Fish dumplings (20 - 40 g / 1 - 1½ oz apiece)	unperforated	195 - 212 (90 - 100)	100	4 - 8	Line the unperforated cooking container with greaseproof paper.
Lobster, cooked, removed from the shell, reheating	perforated	160 - 175 (70 - 80)	100	10 - 12	
Carp, blue, whole (1.5 kg / 3½ lb)	unperforated	195 - 212 (90 - 100)	100	35 - 45	in broth
Salmon filet (150 g / 5 oz)	perforated	195 - 212 (90 - 100)	100	10 - 12	
Salmon, whole (2.5 kg / 5½ lb)	perforated	212 (100)	100	65 - 75	
Blue mussels (1.5 kg / 3½ lb)	perforated	212 (100)	100	6 - 8	The blue mussels are cooked as soon as their shells open up.

Food	Cooking container	Temperature in °F (°C)	Humidity in %	Cooking time in min.	Observations
Atlantic salmon, whole (800 g / 1 lb 12 oz)	perforated	195 - 212 (90 - 100)	100	18 - 20	
Monkfish filet (300 g / 11 oz each)	Glass pan/wire rack	355 - 390 (180 - 200)	100	8 - 10	In stock
Sea bass, whole (400 g / 14 oz)	perforated	195 - 212 (90 - 100)	100	12 - 18	

## Fish – low-temperature steaming

- When steaming between 160 and 190° F (70 and 90°C) overcooked and the fish does not fall apart so easily. This is especially an advantage for delicate fish.
- The details for the various types of fish refer to fillets.
- Insert the unperforated cooking insert into the first level from the bottom to prevent soiling the cooking compartment with fish juices.
- Serve on a pre-warmed dish.

Food	Cooking container	Temperature in °F (°C)	Humidity in %	Cooking time in min.	Observations
Oysters (10)	unperforated	180 - 190 (80 - 90)	100	2 - 5	in broth
Tilapia (150 g / 5 oz)	perforated	180 - 190 (80 - 90)	100	10 - 12	
Gilthead bream (200 g / 7 oz)	perforated	180 - 190 (80 - 90)	100	12 - 15	
Fish fillet (200 - 300 g / 7 - 11 oz)	perforated	180 - 190 (80 - 90)	100	12 - 15	
Fish terrine	Wire rack	160 - 180 (70 - 80)	100	50 - 90	In a terrine mold For precise cooking point control, use the core temperature probe (see "core temperature probe" chapter).
Trout, whole (250 g / 9 oz)	perforated	180 - 190 (80 - 90)	100	12 - 15	
Halibut (300 g / 11 oz)	perforated	180 - 190 (80 - 90)	100	12 - 15	
Scallops (15 - 30 g / ½ - 1 oz)	unperforated	180 - 190 (80 - 90)	100	4 - 8	The more the scallops weigh, the longer the chosen cooking time should be.
Cod (250 g / 9 oz)	perforated	180 - 190 (80 - 90)	100	10 - 12	
Red snapper (200 g / 7 oz)	perforated	180 - 190 (80 - 90)	100	12 - 15	
Redfish (120 g / 4 oz)	perforated	180 - 190 (80 - 90)	100	10 - 12	
Monkfish (200 g / 7 oz)	perforated	180 - 190 (80 - 90)	100	10 - 15	
Sole rolls, stuffed (150 g / 5 oz apiece)	perforated	180 - 190 (80 - 90)	100	12 - 15	
Turbot (300 g / 11 oz)	perforated	180 - 190 (80 - 90)	100	12 - 15	
Sea bass (150 g / 5 oz)	perforated	180 - 190 (80 - 90)	100	10 - 12	
Pike-perch (250 g / 9 oz)	perforated	180 - 190 (80 - 90)	100	12 - 15	

## Meat – cooking at higher temperatures

- The combination of steam and hot air is the optimal cooking process for many types of meat. The cooking compartment is hermetically sealed in this mode, the moisture prevents the meat from drying out as in conventional hot air. Thanks to the variable humidity control, the optimal climate can be achieved for every type of food.
- The cooking times specified should be regarded as guidelines and depend heavily on the initial temperature of the food and the length of time roasted. For better results, use the core temperature probe. For notes and optimal target temperatures, see the "core temperature probe" chapter.
- Take the meat out of the refrigerator 1 hour before preparation.
- If you are using the perforated cooking inserts or the wire rack, insert an unperforated cooking container underneath. Put a little water in the unperforated cooking insert to prevent burning. In addition, you can add vegetables, wine, spices and herbs in order to create a tasty sauce base.
- If you would like to cook the meat so it is medium or rare: open the door 40° F (5° C) before the desired core temperature is reached and wait until the target temperature has been reached. This way you prevent overcooking and you give the meat the necessary time to rest.
- Meat's time to rest: Let the meat rest on a wire rack for 5 min. after cooking. This way, the meat can "relax." The circulation of the meat juice slows down and there is less loss of juice when cutting into the meat.

Food	Cooking container	Temperature in ° F (° C)	Humidity in %	Cooking time in min.	Observations
Entrecôte, medium rare (350 g / 12 oz)	unperforated	340 - 355 (170 - 180)	30	10 - 20	
Filet, browned, medium rare in puff pastry (600 g / 1 lb 5 oz)	unperforated	355 - 390 (180 - 200)	80 / 100	30 - 45	Line the cooking container with greaseproof paper.
Rack of veal, browned, medium rare (1 kg / 2 lb 4 oz)	unperforated	320 - 355 (160 - 180)	30 / 60	20 - 30	If you add liquid to the unperforated cooking container, 30% humidity is sufficient.
Smoked pork, cooked, in slices	unperforated	212 (100)	100	15 - 20	
Roast pork with crackling (pork roast with crust), cooked through (1.5 kg / 3½ lb)	Wire rack	1) 250 (120)	100	30	Make crosswise cuts into the crackling before cooking.  Use core temperature probe: in the second cooking step, cook up to a core temperature of approx. 140° F (60° C), in the third step up to a core temperature of 170 - 176° F (75 - 80° C).
		2) 300 - 320 (150 - 160)	80	30 - 40	
		3) 430 - 445 (220 - 230)	0	20 - 40	
Rack of lamb, browned, medium rare (150 g / 5 oz)	unperforated	320 - 340 (160 - 170)	0 / 30	12 - 15	
Leg of lamb, browned, medium rare (1.5 kg / 3½ lb)	unperforated	340 - 355 (170 - 180)	30 / 60	60 - 80	
Saddle of venison, browned, medium rare (500 g / 1 lb 2 oz)	unperforated	320 - 340 (160 - 170)	0 / 30	12 - 18	
Roast beef, well-done (1.5 kg / 3½ lb)	Wire rack	1) 410 - 445 (210 - 230)	100	15 - 20	If you add liquid to the unperforated cooking container, 30% humidity is sufficient.
		2) 285 - 320 (140 - 160)	30 / 60	60 - 90	
Sirloin, browned, medium rare (1 kg / 2 lb 4 oz)	unperforated	340 - 355 (170 - 180)	30	50 - 60	

Food	Cooking container	Temperature in ° F (° C)	Humidity in %	Cooking time in min.	Observations
Pork roast (neck or shoulder), well-done (1 - 1.5 kg / 2 lb 4 oz - 3½ lb)	Wire rack	1) 390 - 430 (200 - 220)	100	15	If you add liquid to the unperforated cooking container, 30% humidity is sufficient.
		2) 320 - 355 (160 - 180)	60	40 - 60	
Sausage, boiled, heating	unperforated	185 - 195 (85 - 90)	100	10 - 20	e.g. Lyon sausage, white sausage

## Meat/poultry – low-temperature cooking

- Meat browned crisp needs to rest for a longer period at low temperature. This way, the meat gets evenly pink and extremely juicy but for a very thin crusty edge. Here, neither turning nor basting are required.
- The cooking times specified should be regarded as guidelines and depend heavily on the initial temperature of the food and the length of time roasted. For better results, use the core temperature probe. For notes and optimal target temperatures, see the "core temperature probe" chapter.
- Take the meat out of the refrigerator 1 hour before preparation.
- For hygienic reasons, brown the meat on all sides in the pan briefly and over high heat before cooking. This way, the meat has a crust that prevents the juices from escaping and provides a typical roast flavor.
- Season carefully: the slow resting of the meat intensifies all flavors.
- With game and horse meat, the flavor is stronger with low-temperature cooking than with a classic preparation.
- Use the "Low-temperature cooking" mode  $\curvearrowright$ . Any steam escaping from the food therefore remains in the cooking compartment and prevents the food from drying out.
- Please note that you cannot reach any core temperatures above the cooking compartment temperature. The rule of thumb is: the set cooking compartment temperature should be 50 - 60°F (10-15 °C) above the desired core temperature.
- Toward the end of the cooking time, you can reduce the temperature to 140°F (60 °C). This way, you can extend the cooking time (e.g. if your guests arrive late). If you want to stop the cooking process, the cooking compartment temperature may not be higher than the desired core temperature. Thus, large pieces can remain in the cooking compartment for 1 - 1.5 hours, small pieces for 30-45 minutes.
- Serve on a pre-warmed dish.

Food	Cooking container	Temperature in ° F (° C)	Type of heating	Cooking time in min.	Observations
Duck breast, medium rare (350 g / 12 oz)	unperforated	160 - 175 (70 - 80)	$\curvearrowright$	40 - 60	Skin side can be browned crisp in the pan after cooking.
Entrecôte, medium rare (350 g / 12 oz)	unperforated	160 - 175 (70 - 80)	$\curvearrowright$	40 - 70	
Leg of lamb, boned, trussed, medium (1.5 kg / 3½ lb)	unperforated	160 - 175 (70 - 80)	$\curvearrowright$	180 - 240	Before cooking, turn in oil with garlic and herbs.
Beef steaks, medium rare (175 g / 6 oz)	unperforated	160 - 175 (70 - 80)	$\curvearrowright$	30 - 60	
Sirloin, medium rare (1 - 1.5 kg / 2 lb 4 oz - 3½ lb)	unperforated	160 - 175 (70 - 80)	$\curvearrowright$	150 - 210	Cut in slices and serve with Béchamel sauce.
Pork medallions, well-done (70 g / 2½ oz apiece)	unperforated	175 (80)	$\curvearrowright$	50 - 70	

## Poultry

- The humidity for combination operation prevents the drying out, which is essential with poultry. At the same time, thanks to the high temperature, the surface gets crispy and brown. The hot steam has twice as much ability to transfer heat as conventional hot air and reaches all parts of the food. Therefore, a chicken is browned evenly and gets crispy, yet the breast meat remains tender and juicy.
- The cooking times specified should be regarded as guidelines and depend heavily on the initial temperature of the food and the food cooked. For better results, use the core temperature sensor. Do not place it in the middle (hollow space), but rather between the belly and upper thigh. For notes and optimal target temperatures, see the "core temperature probe" chapter.
- If you season poultry primarily with spices and with little or no oil, the skin gets crispier.

Food	Cooking container	Temperature in °F (°C)	Humidity in %	Cooking time in min.	Observations
Duck, whole (3 kg / 6½ lb)	unperforated	1) 300 - 320 (150 - 160)	60	80 - 90	Cook breast side down. After half the cooking time, turn the duck. This way, the delicate breast meat will not dry out so much.
		2) 430 (220)	0	20 - 30	
Duck breast, medium rare (350 g / 12 oz)	unperforated	320 (160)	0	25 - 30	
Chicken, whole (1.5 kg / 3½ lb)	Wire rack	1) 340 - 355 (170 - 180)	60	35 - 45	Cook with trussed legs and breast side up.
		2) 375 (190)	0	15 - 20	
Chicken breast, filled, steamed (200 g / 7 oz)	perforated	212 (100)	100	10 - 15	Recipe tip: fill with spinach and sheep's cheese.
Turkey breast fillet, steamed (300 g / 11 oz)	perforated	212 (100)	100	12 - 15	
Spring chicken, quail, steamed (150 - 200 g / 5 - 7 oz)	perforated	212 (100)	100	15 - 20	
Spring chicken, quail (150 - 200 g / 5 - 7 oz)	unperforated	355 - 390 (180 - 200)	60 / 80	15 - 20	Recipe tip: brush with oil and herbes de Provence.
Pigeon, steamed (300 g / 11 oz)	perforated	212 (100)	100	20 - 30	
Pigeon (300 g / 11 oz)	unperforated	355 - 390 (180 - 200)	60 / 80	25 - 30	

## Sous-vide cooking

Sous-vide cooking is a method of cooking under a vacuum at low temperatures between 120 - 200°F (50 - 95 °C) and in 100% steam.

Sous-vide cooking is a gentle, low-fat method of preparing meat, fish, vegetables and desserts. A vacuum-packing machine is used to heat-seal the food in a special air-tight, heat-resistant cooking bag.

The protective envelope retains the nutrients and flavors. The low temperatures and the direct transfer of heat allow precisely controlled cooking in order to achieve the desired cooking results. It is almost impossible to overcook the food.

### Portions

Use the portion sizes listed in the cooking table. For relatively large quantities and items, the cooking time must be adjusted accordingly.

The portions given for fish, meat and poultry correspond to a single serving. A portion size sufficient for four people has been selected for vegetables and desserts.

### Rack levels

You can cook on up to two levels. Place the cooking containers on levels 1 and 3 to achieve the best cooking results. When cooking on just one level, use level 2.

### Hygiene

---

#### WARNING

---

##### Health risk

Sous-vide cooking is a method of cooking at low temperatures. As a result, it is important that you always follow the application and hygiene instructions below:

---

- Use only fresh, good-quality food.
- Wash and disinfect your hands. Use disposable gloves or cooking/grill tongs.
- Take extra care when preparing critical food, such as poultry, eggs and fish.
- Always thoroughly rinse and/or peel fruit and vegetables.
- Always keep work surfaces and chopping boards clean. Use different chopping boards for different types of food.
- Maintain the cold chain. Make sure that you only interrupt it briefly to prepare the food, and then return the food in its vacuum-sealed bag to the refrigerator for storage before you cook it.
- Food is suitable for immediate consumption only. Once the food is cooked, consume it immediately. Do not store it after cooking – not even in the refrigerator. It is not suitable for reheating.

### Vacuum-pack bags

When using the sous-vide cooking method, only use heat-resistant vacuum-pack bags designed for this purpose.

Do not cook the food in the bag you bought it in (e.g. portions of fish). These bags are not suitable for sous-vide cooking.

### Vacuum sealing

Use a chamber vacuum-packing machine that can create a vacuum of at least 99% to vacuum-seal the food. This is the only way to achieve even heat transfer and therefore a perfect cooking result.

Before cooking the food, check whether the vacuum in the bag is intact. Make sure that:

- There is no/hardly any air in the vacuum-pack bag.
- The seam is perfectly sealed.
- There are no holes in the vacuum-pack bag. Do not use the core temperature probe.
- Pieces of meat and fish that have been vacuum-sealed together are not pressed directly against one another.
- As far as possible, you avoid piling up vegetables and desserts when vacuum-sealing them.

If in doubt, place the food into a new bag and vacuum-seal it again.

Food should be vacuum-sealed at most one day before it is cooked. This is the only way to prevent the escape of gases from the food (e.g. from vegetables) which inhibit the transfer of heat, or to prevent the texture of the food from changing, and thus altering how it cooks.

### Quality of the food

The quality of the cooking result is 100% influenced by the quality of the ingredients you use. Use only fresh, top-quality food. This is the only way to guarantee a consistent cooking result that delivers impeccable flavor.

### Preparation

Sous-vide cooking prevents flavors from escaping, intensifying the food's natural flavor. Please note that the usual quantities of seasoning and condiments, such as herbs, spices and garlic, will have a much greater effect on the flavor. Start off by halving the quantities you usually use.

If the ingredients are of high quality, it is often sufficient to enclose them in the bag with just a small piece of butter and a little salt and pepper. Generally, the fact that the food's natural flavors intensify during cooking is sufficient on its own to produce a flavorful cooking result.

Do not place the vacuum-sealed food items on top of one another or too close together in the cooking

containers. In order to ensure that the heat is distributed evenly, the food items should not be touching. If you have more than one vacuum-pack bag, cook on two levels.

Remove the vacuum-pack bags with care after cooking as hot water accumulates on the bags. Place the unperforated cooking container on the rack underneath the perforated cooking container containing the hot food.

Dry the outside of the bag, place it into a clean, unperforated cooking container and cut it open with scissors. Place all of the food, along with its juices, into the cooking container.

**The food can be finished off as follows once the sous-vide cooking stage is complete:**

**Meat:** Flash fry at a very high temperature for a few seconds only on each side. This gives it a nice crust and the flavors you would expect from frying, without













overcooking it. You can achieve a particularly good result using a teppan yaki or a grill. Important: Dab the meat with a paper towel before placing it into hot oil, in order to avoid fat spitting out of the pan.

**Vegetables:** Flash fry in a frying pan or on a teppan yaki to give them the flavors you would expect from frying. When frying vegetables like this, it is easy to season them or mix them with other ingredients without them cooling down.

**Fish:** Season and coat with hot butter. Since many types of fish fall apart easily after cooking using the sous-vide method, if you wish to flash fry it, this should be done before the sous-vide cooking stage.



Fry the food for longer if has not been sufficiently well cooked during the sous-vide cooking stage.

Serve the food on pre-heated plates and, if possible, with a hot sauce or butter as sous-vide cooking takes place at relatively low temperatures.

Food	Cooking container	Temperature in ° F (° C)	Type of heating	Cooking time in min.	Observations
<b>Meat</b>					
Entrecôte, rare (180 g / 6 oz)	perforated	136 (58)	 100%	100	Once the meat is cooked, flash fry it on a teppan yaki or grill it at a high temperature on both sides. This gives the meat a nice crust and the flavors you would expect from frying, without overcooking it.
Entrecôte, medium rare (180 g / 6 oz)	perforated	145 (63)	 100%	90	
Entrecôte, well done (180 g / 6 oz)	perforated	158 (70)	 100%	85	
Veal topside steaks (160 g / 5½ oz)	perforated	140 (60)	 100%	80	
Beef steaks, rare (180 g / 6 oz)	perforated	136 (58)	 100%	60	
Beef steaks, medium rare (180 g / 6 oz)	perforated	145 (63)	 100%	50	
Beef steaks, well done (180 g / 6 oz)	perforated	158 (70)	 100%	45	
Pork medallions (80 g / 3 oz)	perforated	145 (63)	 100%	75	
<b>Poultry</b>					
Duck breast (350 g / 12 oz)	perforated	136 (58)	 100%	70	Once the breast is cooked, fry the skin side in a hot frying pan until it is crispy.
Foie gras (300 g / 11 oz / 1 round)	perforated	176 (80)	 100%	30	Recipe tip: Wash the goose liver and mix it with other ingredients. Roll it in foil and prick it several times. Vacuum-seal the round and leave it to chill for several hours in the refrigerator before cooking it using the sous-vide method.
Chicken breast (250 g / 9 oz)	perforated	149 (65)	 100%	60	
<b>Fish and seafood</b>					
Prawns (125 g / 4½ oz)	perforated	140 (60)	 100%	30	Recipe tip: Vacuum-seal along with some olive oil, salt and garlic.













Food	Cooking container	Temperature in ° F (° C)	Type of heating	Cooking time in min.	Observations
Scallops (20 - 50 g / piece) (1 - 2 oz / piece)	perforated	140 (60)	100%	6 - 10	The more the scallops weigh, the longer the chosen cooking time should be.
Cod (140 g / 5 oz)	perforated	138 (59)	100%	25	
Salmon fillet (140 g / 5 oz)	perforated	136 (58)	100%	30	If you wish, you can flash fry the salmon fillet in a hot frying pan once it is cooked.
Pike-perch (140 g / 5 oz)	perforated	140 (60)	100%	20	
<b>Vegetables</b>					
Mushrooms, quartered (500 g / 1 lb 2 oz)	perforated	185 (85)	100%	20	Recipe tip: Vacuum-seal along with some butter, rosemary, garlic and salt.
Chicory, halved (4 - 6 pieces)	perforated	185 (85)	100%	40	Recipe tip: Cut the chicory in half. Vacuum-seal along with some orange juice, sugar, salt, butter and thyme.
White asparagus, whole (500 g / 1 lb 2 oz) Green asparagus, whole (600 g / 1 lb 5 oz)	perforated	185 (85)	100%	15 - 20	Recipe tip: Blanch before vacuum-sealing to retain the color. Vacuum-seal along with some butter, salt and pepper.
Carrots, in slices 0.5 cm (600 g / 1 lb 5 oz)	perforated	200 (95)	100%	35 - 40	Recipe tip: Vacuum-seal along with some orange juice, curry and butter.
Potatoes, peeled, in 2 x 2 cm cubes (800 g / 1 lb 12 oz)	perforated	200 (95)	100%	40	Recipe tip: Vacuum-seal along with some butter and salt. Can easily be used for making dishes such as salad.
Potatoes, skin on, whole or halved (800 g / 1 lb 12 oz)	perforated	200 (95)	100%	50	Recipe tip: Vacuum-seal along with some butter and salt. Wash thoroughly beforehand.
Cherry tomatoes, whole or halved (500 g / 1 lb 2 oz)	perforated	185 (85)	100%	15	Recipe tip: Vacuum-seal along with some olive oil, salt and sugar. Mix together red and yellow cherry tomatoes.
Pumpkin, in 2 x 2 cm cubes (600 g / 1 lb 5 oz)	perforated	194 (90)	100%	20 - 25	The cooking time may vary depending on the type of pumpkin.
Zucchini, in 1 cm slices (600 g / 1 lb 5 oz)	perforated	185 (85)	100%	30	Recipe tip: Vacuum-seal along with some olive oil, salt and thyme.
Snap peas, whole (500 g / 1 lb 2 oz)	perforated	185 (85)	100%	5 - 10	Recipe tip: Vacuum-seal along with some butter and salt.
<b>Dessert</b>					
Pineapple in 1.5 cm slices (400 g / 14 oz)	perforated	185 (85)	100%	70	Recipe tip: Vacuum-seal along with some butter, honey and vanilla.
Apple, peeled, in 0.5 cm slices (2 - 4 pieces)	perforated	185 (85)	100%	10 - 15	Recipe tip: Vacuum-seal along with some caramel sauce.
Bananas, whole (2 - 4 pieces)	perforated	149 (65)	100%	15 - 20	Recipe tip: Vacuum-seal along with some butter, honey and a vanilla pod.
Pear, peeled, sliced (2 - 4 pieces)	perforated	185 (85)	100%	30	Recipe tip: Add honey or sugar to sweeten.

Food	Cooking container	Temperature in ° F (° C)	Type of heating	Cooking time in min.	Observations
Kumquats, halved (12 - 16 pieces)	perforated	185 (85)	 100%	75	Recipe tip: Vacuum-seal along with some butter, a vanilla pod, honey and apricot jam. Rinse under warm water, cut in half and deseed.
Vanilla sauce (0.5 l / 2 cup)	perforated	180 (82)	 100%	18 - 20	Recipe tip: 0.5 l / 2 cup milk, 1 egg, 3 egg yolks, 80 g / 3 oz sugar, 1 vanilla pod.

## Grilling

- With the help of the various grill functions, the food can be browned more if necessary.
- For all operating modes with full surface grill, use only the cooking levels 1 to 3. Grill only with the door closed.
- Use different slide-in levels for the desired browning. On the first level from the bottom, you will get a little browning; on the third level, more browning.
- If the browning is too slight, you can re-grill on the second level using the full surface grill operating mode.
- With the operating modes full surface grill and full surface grill + circulated air, do not preheat longer than 5 minutes, since the grill takes effect after 5 minutes.
- Do not use the core temperature probe with the operating modes full surface grill, full surface grill + circulated air and full surface grill + humidity.

Food	Cooking container, level	Temperature in ° F (° C)	Type of heating	Cooking time in min.	Observations
Meringue topping (on cake/dessert)	Wire rack 2	445 (230)		3 - 5	
Open-face sandwich	Wire rack + unperforated 2 / 3	390 (200)		10 - 12	
Trout (whole)	Wire rack + unperforated 3	445 (230)		10 - 12 per side	Recipe tip: fill with lemon slices and parsley.
Grilled vegetables (700 g / 1 lb 9 oz)	unperforated 2	445 (230)		20 - 25	e.g. zucchini, eggplant
Vegetable bake	unperforated 2	355 (180)	 1	35 - 40	e.g. with broccoli and cauliflower
Vegetable skewers	Wire rack + unperforated 3	445 (230)	 / 	12 - 14 per side	Cooking time depends on the types of vegetables.
Chicken legs (350 g / 12 oz each)	Wire rack + unperforated 2 / 3	355 - 390 (180 - 200)	 2	35 - 40	
Potato gratin (1 kg / 2 lbs 4 oz potatoes)	unperforated 2	355 (180)	 1	35 - 40	
Toast (according to EN60350-1)	Wire rack 2	445 (230)		4 - 5	Preheat for 5 minutes.
Zucchini au gratin, stuffed, halved lengthwise	unperforated 2	355 (180)	 2	20 - 25	

## Side dishes

Also note the instructions on the packaging.

Food	Cooking container	Temperature in °F (°C)	Humidity in %	Cooking time in min.	Observations
Basmati rice (250 g + 500 ml of water / 9 oz + 1 pint of water)	unperforated	212 (100)	100	15 - 20	
Couscous (250 g + 250 ml of water / 9 oz + 1/2 pint of water)	unperforated	212 (100)	100	5 - 10	
Dumplings (90 g / 3 oz apiece)	perforated/ unperforated	205 - 212 (95 - 100)	100	20 - 25	
Long-grain rice (250 g + 500 ml of water/ 9 oz + 1 pint of water)	unperforated	212 (100)	100	20 - 25	
Brown rice (250 g + 375 ml of water / 9 oz + 0.8 pint of water)	unperforated	212 (100)	100	25 - 35	
Lentils (250 g + 500 ml of water/ 9 oz + 1 pint of water)	unperforated	212 (100)	100	25 - 35	
White beans, pre-softened (250 g + 1 l of water / 9 oz + 2 pint of water)	unperforated	212 (100)	100	55 - 65	

## Desserts

Food	Cooking container	Temperature in °F (°C)	Humidity in %	Cooking time in min.	Observations
Crème brûlée (130 g / 4 1/2 oz)	unperforated	195 (90)	100	40 - 45	In soufflé pan, cover with heat-resistant plastic wrap.
Steamed dumplings / yeast dumplings (100 g / 3 1/2 oz apiece)	unperforated	212 (100)	100	20 - 30	Let the steamed dumplings rise 30 min. before steaming (see "Cooking" chapter).
Flan / Crème caramel (130 g / 4 1/2 oz)	perforated	195 - 205 (90 - 95)	100	30 - 35	In soufflé pan, cover with heat-resistant plastic wrap.
Compote	unperforated	212 (100)	100	15 - 25	e.g. apples, pears, rhubarb Recipe tip: add sugar, vanilla sugar, cinnamon or lemon juice.
Rice pudding (250 g / 9 oz of rice + 625 ml / 1.3 pint of milk)	unperforated	212 (100)	100	35 - 45	Recipe tip: add fruits, sugar or cinnamon.
Sweet bake	unperforated	355 - 390 (180 - 200)	0 / 60	20 - 40	e.g. semolina, quark or pre-cooked rice pudding

## Other

Food	Cooking container	Temperature in °F (°C)	Humidity in %	Cooking time in min.	Observations
Disinfect (e.g. baby bottles, canning jars)	Wire rack	212 (100)	100	20 - 25	
Drying fruit or vegetables	perforated	175 - 210 (80 - 100)	0	180 - 300	e.g. tomatoes, mushrooms, zucchini, apples, pears, etc. in thin slices
Eggs, size M (5)	perforated	212 (100)	100	8 - 15	
Egg custard (500 g / 1 lb 2 oz)	Glass pan, wire rack	195 (90)	80 - 100	25 - 30	Cover with heat-resistant plastic wrap.
Semolina dumplings	unperforated	195 - 205 (90 - 95)	100	8 - 10	
Lasagne	unperforated	340 - 375 (170 - 190)	0 / 60	35 - 60	
Soufflé	Soufflé pan, wire rack	355 - 390 (180 - 200)	60	12 - 20	
Melting chocolate	Heat-resistant bowl, wire rack	212 (100)	100	5 - 8	Cover with heat-resistant plastic wrap.

## Baked goods

- With the combination steam oven, you can always prepare your baked goods with the optimal humidity:
  - 0% | Hot air and 0% humidity:  
For cake with fruit topping and quiche, excess humidity can escape. This operation mode corresponds to the hot air in the conventional baking oven.
  - 30% | Hot air and 30% humidity:  
Sponge cakes do not dry out. The humidity in the food cannot escape from the cooking compartment.
  - 60% - 100% | Hot air + 60 - 100% humidity:  
Puff pastry and yeast-risen pastry are fluffy inside and crispy outside, with a gloss.
- In the combination steam oven, you can only bake on one level. Insert the unperforated cooking insert into the second level. If you are using a high baking pan, place it on the wire rack that you insert into the first level.
- For steam injection - possible in hot air mode (0% humidity) and humidity level 30% - humidity is fed to the food abruptly by touching the  symbol. Among other things, when used at the beginning of the baking process when baking bread, this function ensures more volume and a crispier crust.

Food	Cooking container	Temperature in °F (°C)	Humidity in %	Cooking time in min.	Observations
Apple pie (according to EN60350-1)	Springform cake pan 20 cm, wire rack	320 (160)	0	110	Pre-heat
Bagels	unperforated	375 - 410 (190 - 210)	80 - 100	20 - 25	
Baguettes, pre-baked	Wire rack	375 - 390 (190 - 200)	0 - 80	10 - 15	
Sponge base, high (6 eggs)	Springform cake pan	320 - 340 (160 - 170)	0	30 - 35	
Sponge base, low (2 eggs)	unperforated	375 - 410 (190 - 210)	0 - 30	8 - 10	e.g. for Swiss roll
Puff pastry goods	unperforated	375 - 410 (190 - 210)	80 - 100	10 - 18	e.g. with poppy seed, marzipan or savory with ham, cheese
Brioche, rolls	unperforated	320 (160)	0	8 - 12	

Food	Cooking container	Temperature in °F (°C)	Humidity in %	Cooking time in min.	Observations
Rolls (50 - 100 g / 2 - 3½ oz apiece)	unperforated	355 - 390 (180 - 200)	80 - 100	15 - 25	You can also bake rolls very well as follows: preheat to 430°F (220°C) with 30% humidity. After inserting the baked goods into the appliance, inject steam once or twice after 5 minutes at 0% and turn down to 375°F (190°C).
Rolls, pre-baked	Wire rack	300 - 340 (150 - 170)	0	8 - 15	Inject steam at the beginning.
Bread (0.5 - 1 kg / 1 - 2 lbs)	unperforated	1) 410 - 445 (210 - 230)	30	15 - 20	Inject steam 2-3 times at the beginning.
		2) 330 (165)	0	35 - 50	For precise cooking point control, use the core temperature probe (see "core temperature probe" chapter). Place on the wire rack to cool.
Flat cake of sponge batter	unperforated	320 - 330 (160 - 165)	0	35 - 40	
Bundt cake (1 kg / 8 cup flour)	Bundt cake pan, wire rack	320 - 345 (160 - 175)	30	45 - 50	
Yeast sheet cake	unperforated	320 - 340 (160 - 170)	0 - 60	30 - 45	For yeast-risen sheet cakes with moist topping (e.g. plum cake or onion tart) 0% and with dry topping (e.g. streusel) 60% humidity.
Plaited loaf (500g / 4 cup flour)	unperforated	320 - 340 (160 - 170)	60 - 80	25 - 35	
Muffins	Muffin tin, wire rack	340 - 355 (170 - 180)	0 - 30	20 - 30	
Macaroons	unperforated	300 - 320 (150 - 160)	0	15 - 20	
Cookies,	unperforated	300 - 350 (150 - 175)	0	10 - 20	
Quiche, Wähe	Quiche pan, wire rack	375 - 410 (190 - 210)	0	45 - 60	
Sponge cake	Loaf pan/spring- form cake pan, wire rack	330 - 340 (165 - 170)	0 - 30	60 - 65	
Small cakes	unperforated	320 (160)	0	30	
Piped cookies (according to EN60350-1)	unperforated	330 (165)	0	30 - 32	Pre-heat
Tart	Tart pan, wire rack	375 - 390 (190 - 200)	0 - 30	30 - 45	e.g. with apples, chocolate, apricots or savory with asparagus, onions, cheese
Hot water sponge cake (according to EN60350-1)	unperforated	300 (150)	0	40	Pre-heat
Cream puffs, eclairs	unperforated	355 - 375 (180 - 190)	0 - 30	40 - 45	

## Dough proving (leaving to rise)

- The combination steam oven offers the ideal climate for letting rise and making baked goods without drying out.
- For this, use the "Hot air + 60% humidity" operation mode.
- The bowl does not have to be covered with a damp cloth. Rising takes only half as long as in the usual way.
- The suggested cooking time is only a guideline. Let the dough rise until its volume has doubled.

Food	Cooking container	Temperature in °F (°C)	Humidity in %	Cooking time in min.	Observations
Dough mixture (600 g / 5 cup flour)	Bowl/ wire rack	100 - 105 (38 - 40)	60	30 - 45	e.g. yeast dough, natural fermentation starter, sourdough

## Refreshing (warming up)

- The combi-steam oven creates the perfect environment for reheating cooked food without drying it out. The flavour and quality are virtually indistinguishable from food that has been freshly prepared.
- To use this function, select "Reheat" mode .
- Do not cover the food. Do not use aluminium foil or clingfilm.
- The figures listed are for portions for one person. Larger quantities of food can also be warmed up in the unperforated cooking insert; you will need to cook the food for longer than the times specified in the table.

Food	Cooking container	Temperature in °F (°C)	Cooking time in min.	Observations
Baguettes, rolls (frozen)	Wire rack	285 (140)	10 - 15	
Baguettes, rolls (day-old)	Wire rack	355 (180)	5 - 8	
Roast, in slices (150 g / 5 oz)	unperforated	250 (120)	12 - 15	Finger-thick slices, do not place on top of each other, to keep juicy, add sauce to the cooking container.
Vegetables	Plate, wire rack	195 - 212 (90 - 100)	8 - 10	
Pizza, thin	Wire rack	355 (180)	10 - 12	
Pizza, thick	Wire rack	355 (180)	12 - 14	
Starchy side dishes	Plate, wire rack	250 (120)	7 - 8	e.g. noodles, potatoes, rice, not suitable are baked or fried foods such as french fries or croquettes
Plated meals	Plate, wire rack	250 (120)	8 - 15	

## Defrosting

- In the steam oven you can gently and evenly thaw deep frozen foods faster than at room temperature.
- Use the "Defrosting" mode \* $\delta$  to do this.
- The specified thawing times are for your orientation only. The time it takes to thaw depends on the size and weight of the frozen food: freeze your foods flatly or individually. This shortens the thawing time.
- Take foods out of the packaging before thawing them.
- Thaw only the amount you immediately need.
- Remember: in certain circumstances, thawed food does not keep so well and goes bad faster than fresh food. Immediately process thawed food and cook it thoroughly.

- After half of the thawing time, turn meat or fish over fish or separate fragmentary frozen food such as berries or bits of meat. Fish need not thaw fully. It suffices if the surface is soft enough to absorb the spices.

### WARNING

#### Health risk

When thawing animal foodstuffs, it is imperative to remove the liquid that arises during thawing. It must never come into contact with other foodstuffs. Germs could be transmitted. Slide the unperforated cooking insert underneath the food. Pour away the collected thawing liquid from meat and poultry. Then clean the sink and rinse with plenty of water. Clean the cooking insert in hot soapy solution or in a dishwasher. After defrosting, operate the steam oven for 15 minutes with Convection at 350 °F (approx. 180 °C).

Food	Cooking container	Temperature in °C	Type of heating	Cooking time in min.	Observations
Berries (300 g / 11 oz)	perforated	115 - 120 (45 - 50)	* $\delta$	4 - 6	
Roast (1 - 1.5 kg / 2 lb 4 oz - 3½ lb)	perforated	115 - 120 (45 - 50)	* $\delta$	80 - 110*	
Fish fillet (150 g / 5 oz each)	perforated	115 - 120 (45 - 50)	* $\delta$	8 - 12*	
Vegetables (400 g / 14 oz)	perforated	115 - 120 (45 - 50)	* $\delta$	6 - 8	
Goulash (600 g / 1 lb 5 oz)	perforated	115 - 120 (45 - 50)	* $\delta$	30 - 45*	
Chicken (1 kg / 2 lbs 4 oz)	perforated	115 - 120 (45 - 50)	* $\delta$	45 - 60*	
Chicken legs (400 g / 14 oz each)	perforated	115 - 120 (45 - 50)	* $\delta$	30 - 35*	

\* Add balancing time for this dish: switch appliance off after the defrost time has elapsed and leave the food in the closed appliance for 10 - 15 minutes so that it defrosts all the way to the center.

## Preserving

- In combination steam ovens, you can can fruit and vegetables with little effort.
- If possible, cook food immediately after purchase or harvesting. Longer storage decreases the vitamin content and can cause spoilage.
- Only use fruit and vegetables in good condition.
- The combination steam oven is not suited for preserving meat.
- Check and clean the canning jars, rubber rings, clamps, and springs carefully.
- You can disinfect the clean jars in your combination steam oven at 212 °F (100 °C) and 100% humidity for 20 - 25 min before you preserve the fruit in them.
- Place the jars in the perforated cooking container. They must not be in contact with each other.
- Open the cooking compartment door after the cooking time has elapsed. Do not remove the canning jars from the appliance until they have completely cooled down.

Food	Cooking container	Temperature in °F (°C)	Humidity in %	Cooking time in min.	Observations
Fruit, vegetables (in closed 0.75 l / ½ pint canning jars)	perforated	212 (100)	100	35 - 40	
Beans, peas (in closed 0.75 l / ½ pint canning jars)	perforated	212 (100)	100	120	

## Extracting juice (soft fruits)

- You can effortlessly and cleanly extract berry juice in the steam oven.
- Place the berries in the perforated cooking insert and slide it into the third level from below. Slide in the unperforated cooking insert one level below it to collect the liquid.
- Leave the berries in the appliance until no more juice appears.
- You can then squeeze the berries dry in a dishtowel to preserve the last remainders of juice.

Food	Cooking container	Temperature in °F (°C)	Humidity in %	Cooking time in min.	Observations
Berries	perforated + unperforated	212 (100)	100	60 - 120	

## Preparing yoghurt

- You can even prepare your own yogurt in the combination steam oven.
- Heat pasteurized milk to 195°F (90°C) on the burner in order to prevent a disturbance of the yogurt cultures. Ultra-high-heated milk (H-milk) does not have to be heated. (Note: if you want to make yogurt with cold milk, the resting period is longer).
- NB! Leave milk cool to 105°F (40°C) in the water bath so as not to destroy the yogurt cultures.
- Stir natural yogurt into the milk with active yogurt cultures (1 - 2 teaspoons of yoghurt for every 100 ml).
- For yogurt enzymes, heed the package instructions.
- Fill the yogurt into clean jars.
- You can disinfect the clean jars in your combination steam oven at 212°F (100°C) and 100% humidity for 20 - 25 min before you pour the yogurt in. Make sure to let the jars and the cooking compartment cool off before you pour the yogurt into them and place the jars in the appliance.
- After preparation, put the yogurt in the refrigerator.
- To make thicker yogurt, add skin milk powder to the milk before heating (1-2 tablespoons per liter).

Food	Cooking container	Temperature in °F (°C)	Humidity in %	Cooking time in min.	Observations
Yogurt approach (in sealed jars)	unperforated	115 (45)	100	300 - 360	Recipe tip: if you use the yogurt approach with fruit puree, jam, honey, vanilla or chocolate flavoring, then you may need to extend the preparation time.



## Preparing bulky food

- For the preparation of bulky foods, you can also remove the side slide-in tray.
- To do this, loosen the knurled screws at the front of the slide-in tray and pull the tray out toward the front.
- Place the wire rack directly on the bottom of the cooking compartment and place the food or the roasting dishes on the wire rack. Do not place the food or the roasting dishes directly on the enameled bottom.

## Acrylamide in foodstuffs

Which foods are affected?

Acrylamide is mainly produced in grain and potato products that are heated to high temperatures, such as chips, fries, toast, rolls, bread, fine baked goods (cookies, gingerbread, Christmas spice cookies).

---

### Tips for keeping acrylamide to a minimum when preparing food

---

General	Keep cooking times as short as possible. Cook food until it is golden brown, but not too dark. Large, thick pieces of food contain less acrylamide.
Baking	With hot air at max. 355° F (180 °C).
Cookies	Egg or egg yolk reduces the production of acrylamide. Spread out a single layer evenly on the baking tray.
Oven French fries	Cook at least 400 g at once on a baking tray so that the fries do not dry out.





**Gaggenau**

BSH Home Appliance Corporation  
1901 Main Street, Suite 600  
Irvine, CA 92614  
+1-877-442-4436

[www.gaggenau.com/us](http://www.gaggenau.com/us)

© 2018 BSH Home Appliances

**Gaggenau Hausgeräte GmbH**

Carl-Wery-Straße 34  
81739 München  
GERMANY

**GAGGENAU**



9000975761 en-us (981220)